

The logo for FIBRAIN, featuring the word "FIBRAIN" in a bold, white, sans-serif font, followed by a stylized red and white graphic element resembling a square with a horizontal bar through it, and a registered trademark symbol (®) to the right.

FIBRAIN®

The main title of the document, "FibraIn DATA Structured Cabling", is displayed in a large, white, sans-serif font. The text is centered and overlaid on a background of a perspective view of a grid of metal mesh, with a red and cyan color scheme that creates a sense of depth and technology.

FibraIn DATA
Structured Cabling

FIBRAINDATA		
COPPER INSTALLATION CABLES	<i>Page 10</i>	CU
COPPER CONNECTORS	<i>Page 28</i>	CU
COPPER PATCH PANELS	<i>Page 36</i>	CU
COPPER PATCH CORDS	<i>Page 49</i>	CU
COPPER TERMINATION OUTLET ACCESSORIES	<i>Page 56</i>	CU
CABINETS	<i>Page 64</i>	CU FO
CABINETS ACCESSORIES	<i>Page 71</i>	CU FO
FIBRAIN LOGIWIRE	<i>Page 76</i>	CU FO

FIBER OPTIC INSTALLATION CABLES	<i>Page 87</i>	FO
FIBER OPTIC CONNECTION HARDWARE	<i>Page 96</i>	FO
FIBER OPTIC PRECONNECTORIZED CABLES	<i>Page 106</i>	FO
FIBER OPTIC PATCH PANELS	<i>Page 120</i>	FO
PATCH PANELS ACCESSORIES	<i>Page 137</i>	FO
FIBER OPTIC TERMINATION OUTLETS	<i>Page 144</i>	FO
FIBER OPTIC TEST ACCESSORIES	<i>Page 148</i>	FO



FIBRAINDATA

FibrainDATA - striving High class components of structured



RELIABILITY GUARANTEE
Three-level warranty system:
product, system, application



COMPLETE SOLUTIONS
Comprehensive portfolio
of **FO & Copper structured
cabling solutions**



MANUFACTURING IN POLAND
Manufacturing centers are located
in Rzeszów, Rogoźnica, Jasionka, Zaczerwie

for perfection

cabling systems create complex solutions



TRAINING SCHEME

Two-level training scheme
to Certified Installers & Designers



VERIFIED IN PROJECTS

More than **500 buildings** certified in Poland
and **400 foreign installations**



REQUIREMENTS FULFILLMENT

System verified in the independent 3P Third
Part Test laboratory and in National Institute
of Telecommunications

FIBRAINDATA structured cabling

Structured cabling solutions are well-known and fully certified solutions to meet specific requirements. Designed with assistance from network planners and installers, FIBRAINDATA guarantees ease of installation and the highest performance. Exceeding Standards, fulfilling highest requirements and ensuring warranty system for at least 25 years - these are the main goals, which we have in mind when designing FIBRAINDATA system. Undoubtedly, our dynamically developing R&D department and well-equipped laboratory are involved in a wide range of activities to achieve our aims and provide the best parameters.

■ Company

The principal aim of FIBRAIN company and a common target of all employees is a constant development of the company's profile and services, which meet ever-increasing market needs and customer's requirements. Therefore, one of the main priority is the ongoing expansion and advancement of the manufacturing capabilities. Thanks to highly experienced specialists from various departments, including H&R, company's development is smooth and consistent. Naturally, state-of-the-art technologies and equipment provide the possibilities to perform challenging tasks and customize company's products to meet or even exceed our customers' needs. Therefore, professional service and individual attitude to customers as well as constant upgrading the company's offer and products are one of the crucial priorities.

■ Knowledge

Experienced employees in R&D, Structured Cabling Department and other Department form a team of experts who are ready to take up any challenge. Having one of the best-equipped laboratories in Europe, we are able to test our systems operation in different conditions. The appropriate choice of materials used for production of individual components ensure the best system's transmission parameters and its operation during for at least 25 years. Our professional job attitude as well as commitment and highly qualified workers enable us to achieve the highest goals and ambitions, amongst others, being a world known leader in the telecommunications industry.

System

The main aim of FIBRAINDATA is to create a solution, adjusted to the customer's needs in the best possible way. In order to improve products, FIBRAIN company organizes meetings with experienced technicians, which result in constant implementation of the new improvements in our components. As we have full control of the product, any modifications are implemented almost automatically. Therefore, as a consequence of being an independent company, we can design products and solutions which fulfill the requirements in our region. Therefore, we have managed to create a system corresponding to the needs of wide range of customers- the system of the XXI century. Wide and comprehensive portfolio of solutions allows us to adjust to individual configuration of IT network and gives us a competitive advantage in the market. Our own high requirements, resulted in not only fulfilling but exceeding the ISO/IEC 11801:2011, EIA/TIA-568-D.2.1, EN 50173:2013 Standards.

Our well-known and fully certified solutions are divided into specific systems which comply with the highest requirements and standards

Copper Solutions

Express 5e

Express - Complete D-class system, includes all the components of 5e category which are required when structured cabling system is installed. The system is available in 2 options: UTP and FTP. In both solutions are based on cables with increased frequency up to 200 MHz. Additionally, system includes multi-pair cables of 5e category, which entirely comply with ISO/IEC 11801 norm.

Quick 6

Quick - Complete E-class system includes all components of 6 category which are required when structured cabling system is installed. Comprehensive portfolio of installation cables (U/UTP, F/UTP, U/FTP, S/FTP), as well as increased frequency up to 500 MHz, allow us to fulfill the requirements of even the most demanding customers.

Rapid 6a

Rapid - Complete EA-class system, contains complete range of 6A category components. Solutions fully provide 10Gbps transmission in complete 100m of transmission channel. A system is based on shielded version of transmission components.

ULTRA 7TA

Ultra - Solutions are adjusted to future applications, ensuring assumptions of 7 and 7A categories. It is also based on high quality of telecommunication cables as F/FTP, S/FTP.

Voice

Voice - A system is prepared to be used in digital and analog telephone signal transmission. It perfectly complements telecommunication solution.

Fiber Optic Solutions



Fiber optic solutions - Full comprehensive solution being a part of FIBRAINData cabling system. Offer of FIBRAIN consists of either MM and SM cabling which are segregated according to efficiency. Full scope categories OM1- OM4 for MM and OS1/OS2 for SM. Whole portfolio in full range is based on Bend Insensitive Multimode Fibers (BIMF) and Bend Insensitive Singlemode Fibers (BISF) what make the installation easier keeping the highest transmission parameters on adequate level. FIBRAINDATA offers complete scope of FO connectors, starting from legacy ST, FC ending on the most modern LC and MPO/MTP. FIBRAINData cabling system is ready for the most demanding applications including 40G and 100G in full range of length according to ISO11801 & IEEE

■ Compliance

All of our products have been examined by an external, independent laboratory as a component and also as a transmission channel and a permanent link. For an additional protection, all of them are measured on a daily basis in FIBRAIN internal laboratory and also reviewed by the installers after the implementation process. Moreover, each component is examined with the use of the re-embedded method.

■ FIBRAIN Academy

Responding to the market demand and to help our customers absorb new knowledge and technologies we offer a series of training courses under the common brand name FIBRAIN Academy. We welcome inquiries for customized training modules. As seasoned practitioners we can draw on years of experience and hundreds of projects completed so our courses of always practice-oriented. Therefore, meetings are always tailored to the partner's needs and preferences. Our trainers are open for a discussion and precious knowledge exchange.



■ Certified Installer

Authorized Program of the Certified Installers of FIBRAINDATA is aimed for companies which are focused on project, installation with implementation of structured cabling system. Training Program of Certified Installers conducted by our Product Managers provides essential knowledge, which is necessary to understand and install structured cabling system.

During the training, knowledge in the field of Standards, mounting standards and available components of the system is exchanged. Furthermore, trainings include practical part, which demonstrates installation of individual components. Training's aim is to teach how to install properly structured cabling system, which is covered by 25-year warranty for an operation and application of the system.



■ Certified Designer

Meetings in design offices allow us to obtain knowledge about the latest investors' requirements and needs. Designers can gather knowledge about the newest Standards, editions and conditions which concern modern structured cabling systems.

■ Warranty Program

As our systems meet the highest Standards and requirements, they can work properly for at least 25 years. Each telecommunication system which is designed with the use of FIBRAIN components and installed by Certified Installer can possess warranty program.

■ FIBRAINDATA certification procedure

After implementing the installation, Certified Installer is required to submit all the necessary documents, especially as-built documentation, measurement of complete network with the use of authorized device possessing valid calibration term. As a next step, FIBRAIN examines the network and verifies submitted documents. In case of any inaccuracies or mistakes, Certified Installer is required to correct them or complete the documentation. Afterwards, FIBRAIN issues warranty documents, which must be transferred by Certified Installer to the project investor.



■ Product warranty

All of the components of Certified FIBRAINDATA System are of the highest quality and free from any material and manufacturing defects.

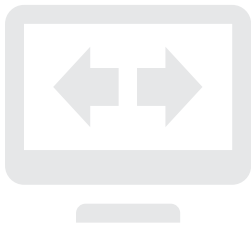

■ System warranty

Transmission Channel of the Certified FIBRAINDATA structured cabling system fulfills the parameters according to the given category. The warranty does not cover products which are used, stored or installed improperly.



■ Application warranty

FIBRAINDATA Certified structured cabling system is free from defects, which does not enable signal transmission based on specific protocols and network applications. This concerns applications and protocols which are established by the committees for standardization IEEE, ANSI, TIA/EIA, ATM Forum and confirmed for transmission requirements based on TIA/EIA 568-B.2 and/or TIA/EIA 568-A, TIA/EIA568-A-5, ISO-IEC 11801 2nd edition, ISO/IEC 11801, EN 50173 Standards and standards.

■ Information materials

Apart from individual meetings, our company has prepared wide range of marketing materials, such as catalogues, publications, technical brochures as well as guides, which have been prepared for a particular group of professionals. Data sheets include all the necessary technical information required for project implementation.

COPPER



FIBRAINDATA

COPPER INSTALLATION CABLES

25-year warranty system guarantees the highest quality

5e



SMALL DIAMETER

**PVC
LSZH**

TWO JACKET TYPES:
PVC AND LSZH

**U/UTP
F/UTP**

TWO CONSTRUCTION TYPES :
U/UTP AND F/UTP

**200
MHz**

INSTALLATION CABLES- DATA
TRANSMISSION FREQUENCIES
UP TO 200 MHz

6



CROSSTALKS REDUCTION
IN U/UTP AND F/UTP
CONSTRUCTION

**U/UTP U/FTP
F/UTP F/FTP
S/FTP**

FULL PORTFOLIO
OF CABLE CONSTRUCTION

**cat. 6
X MHz**

MORE THAN
STANDARD 250 MHz

FR-LSZH

S/FTP CABLE ALSO
IN FLAME RETARDANT
OPTION

COPPER INSTALLATION CABLES

and stable connection

6A



SEPARATOR WITH ANTY-ALIEN CROSSTALK TECHNOLOGY



SUPPORT FOR WHOLE APPLICATIONS INCLUDING 10GBASE-T AT FULL 100M CHANNEL

**LSZH
FR-LSZH**

CONDUCTORS IN TWO JACKET TYPES: LSZH OR FR-LSZH

7A

900
1200
2000
MHz

TRANSMISSION CHARACTERISTIC
7-> 900 MHZ 7A->1200 MHZ
8-> 2000 MHZ

**F/FTP
S/FTP**

FULL SHIELDED SOLUTION FOR THE HIGHEST PROTECTION AGAINST CROSSTALK

Voice

**25
PAIRS**

ADDITIONAL CONSTRUCTION:
25 PAIRS IN 1 JACKET

U/UTP Cat.5e 200 MHz

Express 5e



Cable construction

1. Insulation
2. Conductor
3. Jacket

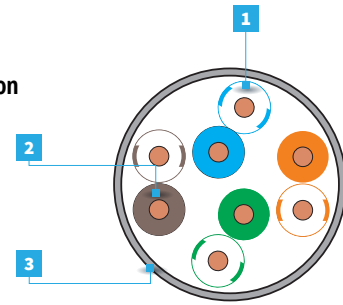

FIBRAINDATA Express U/UTP Cat.5e 200 MHz		
305 m box	XE100.101	XE100.105
500 m drum	XE100.102	XE100.106
1000 m drum	XE100.103	XE100.107
	JACKET - GREY PVC	JACKET - GREEN LSZH

MECHANICAL CHARACTERISTICS	
Min. bending radius in operation [mm]	20
Min. bending radius during installation [mm]	40
Max. pulling tension [N]	80
Nominal weight [kg/km]	29.5
Nom. outer diameter [mm]	5.0
Nom. wire diameter [AWG]	24

ELECTRICAL CHARACTERISTICS @ 20°C	
Max. DC Resistance [Ω /km]	93.8
Nom. Mutual Capacity @1kHz [nF/km]	56
NVP [%]	68
Mean input Impedance [Ω]	100 \pm 5 @ 100MHz
Propagation delay @10MHz [ns]	max. 518
Delay Skew [ns/100m]	max. 40
Segregation class	b
Max. operating voltage [V DC]	80
Max. DC intensity per conductor [A/mm ²]	3.3

ENVIRONMENTAL CHARACTERISTICS	
Jacket material	PVC
Flammability	Acc. to IEC 60332-1-2
Calorific value [MJ/m]	0.377

Frequency [MHz]	Max. attenuation [dB/100 m]	NEXT	PS-NEXT	ACR-F	PS-ACR-F	ACR	PS-ACR	Return loss [dB]
		[dB/100 m] min						
1	2.0	65.3	62.3	63.8	60.8	63.3	60.3	20.0
4	4.1	56.3	53.3	51.8	48.8	52.2	49.2	23.0
8	5.8	51.8	48.8	45.7	42.7	46.0	43.0	24.5
10	6.5	50.3	47.3	43.8	40.8	43.8	40.8	25.0
16	8.2	47.2	44.2	39.7	36.7	39.0	36.0	25.0
25	10.4	44.3	41.3	35.8	32.8	33.9	30.9	24.3
31.25	11.7	42.9	39.9	33.9	30.9	31.2	28.2	23.6
62.5	17.0	38.4	35.4	27.9	24.9	21.4	18.4	21.5
100	22.0	35.3	32.3	23.8	20.8	13.3	10.3	20.1
125*	24.9	33.8	30.8	21.9	18.9	9.0	6.0	19.4
155*	28.1	32.4	29.4	20.0	17.0	4.4	1.4	18.8
200*	32.4	30.8	27.8	17.8	14.8	---	---	18.0

Applications

- 10BASE-T (IEEE 802.3)
- 100BASE-T (IEEE 802.3)
- 1000BASE-T (Gigabit Ethernet)
- 100BASE-VG-AnyLAN
- 100 Mbps TP-PMD (ANSI X3T9.5)
- 4/16 Mbps TOKEN RING (IEEE 802.5) 55/155 Mbps ATM

Standards

- ISO/IEC 11801
- EN 50173
- TIA 568 C.2
- IEC 61156-5
- EN 50288-3-1
- IEC 60332-1-2

Construction

- Conductor (wire) - 24 AWG (0.51 mm)
- Insulation - polyolefin
- Pair number - 4 twisted pairs
- Jacket - grey PVC
- Jacket - green LSZH

TEMPERATURE CHARACTERISTICS

Storage Temperature [°C]	-20 to +70
Operating Temperature [°C]	-20 to +70
During installation [°C]	-5° to +50

*for information only

F/UTP Cat.5e 200 MHz

Express 5e



Cable construction

1. Insulation
2. Drain wire
3. Conductor
4. Aluminium foil
5. Jacket

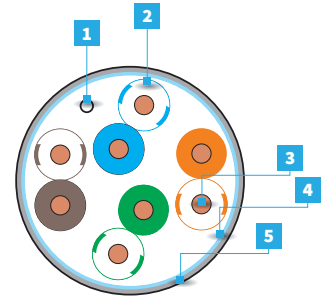

FIBRAINDATA Express F/UTP Cat.5e 200 MHz		
305 m box	XE100.111	XE100.115
500 m drum	XE100.112	XE100.116
1000 m drum	XE100.113	XE100.117
	JACKET - GREY PVC	JACKET - GREEN LSZH

MECHANICAL CHARACTERISTICS	
Min. bending radius in operation [mm]	25
Min. bending radius during installation [mm]	45
Max. pulling tension [N]	80
Nominal weight [kg/km]	36
Nom. outer diameter [mm]	5.6
Nom. wire diameter [AWG]	24

ELECTRICAL CHARACTERISTICS @ 20°C	
Max. DC Resistance [Ω /km]	95
Nom. Mutual Capacity @1kHz [nF/km]	56
NVP [%]	68
Mean input Impedance [Ω]	100 \pm 5 @ 100MHz
Propagation delay @10MHz [ns]	max. 518
Delay Skew [ns/100m]	max. 40
Segregation class	c
Max. operating voltage [V DC]	80
Max. DC intensity per conductor [A/mm ²]	3.3

ENVIRONMENTAL CHARACTERISTICS	
Jacket material	PVC
Flammability	Acc. to IEC 60332-1-2
Calorific value [MJ/m]	0.464

Frequency [MHz]	Max. attenuation [dB/100 m]	NEXT	PS-NEXT	ACR-F	PS-ACR-F	ACR	PS-ACR	Return loss [dB]
		[dB/100 m] min						
1	2.1	65.3	62.3	64.0	61.0	63.2	60.3	20.0
4	4.0	56.3	53.3	52.0	49.0	52.3	49.3	23.0
8	5.6	51.8	48.8	45.9	42.9	46.1	43.1	24.5
10	6.3	50.3	47.3	44.0	41.0	44.0	41.0	25.0
16	8.0	47.2	44.2	39.9	36.9	39.2	36.2	25.0
25	10.1	44.3	41.3	36.0	33.0	34.2	31.2	24.3
31.25	11.4	42.9	39.9	34.1	31.1	31.5	28.5	23.6
62.5	16.5	38.4	35.4	28.1	25.1	21.9	18.9	21.5
100	21.3	35.3	32.3	24.0	21.0	14.0	11.0	20.1
125*	24.1	33.8	30.8	22.1	19.1	9.7	6.7	19.4
155*	27.2	32.4	29.4	20.2	17.2	5.2	2.2	18.8
200*	31.4	30.8	27.8	18.0	15.0	---	---	18.0

Applications

- 10BASE-T (IEEE 802.3)
- 100BASE-T (IEEE 802.3)
- 1000BASE-T (Gigabit Ethernet)
- 100BASE-VG-AnyLAN
- 100 Mbps TP-PMD (ANSI X3T9.5)
- 4/16 Mbps TOKEN RING (IEEE 802.5) 55/155 Mbps ATM

Standards

- ISO/IEC 11801
- EN 50173
- IEC 61156-5
- EN 50288-3-1
- IEC 60332-1-2

Construction

- Conductor (wire) - 24 AWG 0.51 mm
- Insulation - polyolefin
- Pair number- 4 twisted pairs
- Shield - aluminium foil/polyester around all pairs
- Grounding - galvanized copper wire , Φ 0.4 mm
- Jacket - grey PVC
- Jacket - green LSZH

TEMPERATURE CHARACTERISTICS	
Storage Temperature [°C]	-20 to +70
Operating Temperature [°C]	-20 to +70
During installation [°C]	-5° to +50

*for information only

U/UTP Cat.6 500 MHz

Quick 6



Cable construction

1. Conductor
2. Insulation
3. Twisted wires
4. Cross web
5. Jacket

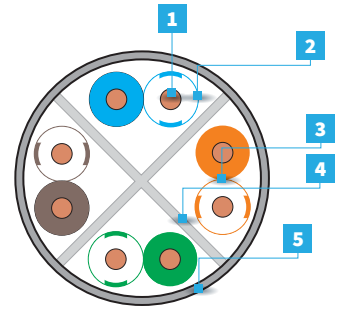

FIBRAINDATA Quick U/UTP Cat.6 500 MHz		
305 m box	XQ100.101	XQ100.105
500 m drum	XQ100.102	XQ100.106
1000 m drum	XQ100.103	XQ100.107
	JACKET - PVC GREY	JACKET - LSZH BLUE

MECHANICAL CHARACTERISTICS	
Min. bending radius in operation [mm]	20
Min. bending radius during installation [mm]	45
Max. pulling tension [N]	95
Nominal weight [kg/km]	36.3
Nom. outer diameter [mm]	5.4
Nom. wire diameter [AWG]	24

ELECTRICAL CHARACTERISTICS @ 20°C	
Max. DC Resistance [Ω /km]	93.8
Nom. Mutual Capacity @1kHz [nF/km]	56
NVP [%]	68
Mean input Impedance [Ω]	100 \pm 5 @ 100MHz
Propagation delay @10MHz [ns]	max. 518
Delay Skew [ns/100m]	max. 40
Segregation class	b
Max. operating voltage [V DC]	80
Max. DC intensity per conductor [A/mm ²]	3.3

ENVIRONMENTAL CHARACTERISTICS	
Jacket material	PVC
Flammability	Acc. to IEC 60332-1-2
Calorific value [MJ/m]	0.52

Frequency [MHz]	Max. attenuation [dB/100 m]	NEXT	PS-NEXT	ACR-F	PS-ACR-F	ACR	PS-ACR	Return loss [dB]
		[dB/100 m] min						
1	2.0	75.3	72.3	68.0	65.0	73.2	70.2	20.0
4	3.8	66.3	63.3	58.0	55.0	62.5	59.5	23.0
8	5.2	61.8	58.8	51.9	48.9	56.5	53.5	24.5
10	5.9	60.3	57.3	50.0	47.0	54.4	51.4	25.0
16	7.4	57.2	54.2	45.9	42.9	49.9	46.9	25.0
25	9.2	54.3	51.3	42.0	39.0	45.0	42.0	24.3
31.25	10.3	52.9	49.9	40.1	37.1	42.6	39.6	23.6
62.5	14.5	48.4	45.4	34.1	31.1	33.8	30.8	21.5
100	18.4	45.3	42.3	30.0	27.0	26.9	23.9	20.1
155	22.9	42.4	39.4	26.2	23.2	19.5	16.5	18.8
200	26.1	40.8	37.8	24.0	21.0	14.7	11.7	18.0
250	29.2	39.3	36.3	22.0	19.0	10.1	7.1	17.3
300*	32.0	38.1	35.1	20.5	17.5	6.1	3.1	17.3
350*	34.7	37.1	34.1	19.1	16.1	2.5	1.0	17.3
500*	48.9	34.8	31.8	16.0	13.0	0.0	---	15.0

Copper cabling

- ### Applications
- 10BASE-T (IEEE 802.3)
 - 100BASE-T (IEEE 802.3)
 - 1000BASE-T (Gigabit Ethernet)
 - 100BASE-VG-AnyLAN
 - 100 Mbps TP-PMD (ANSI X3T9.5)
 - 4/16 Mbps TOKEN RING (IEEE 802.5) 55/155 Mbps ATM

Standards

- ISO/IEC 11801
- EN 50173
- TIA 568 C.2
- IEC 61156-5
- EN 50288-3-1
- IEC 60332-1-2

Construction

- Conductor (wire) - 24 AWG (0.51 mm)
- Insulation - polyolefin
- Pair number - 4 twisted pairs
- Jacket - grey PVC
- Jacket - green LSZH

TEMPERATURE CHARACTERISTICS

Storage Temperature [°C]	-20 to +70
Operating Temperature [°C]	-20 to +70
During installation [°C]	-5° to +50

*for information only

F/UTP Cat.6 350 MHz

Quick 6



Cable construction

1. Insulation
2. Conductor
3. Aluminium foil
4. Drain wire
5. Cross web
6. Jacket

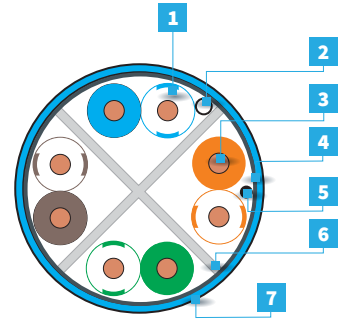

FIBRAINDATA Quick F/UTP Cat.6 Jacket LSZH 350 MHz	
500 m drum	XQ100.116
1000 m drum	XQ100.117
JACKET - LSZH BLUE	

MECHANICAL CHARACTERISTICS	
Min. bending radius in operation [mm]	25
Min. bending radius during installation [mm]	45
Max. pulling tension [N]	80
Nominal weight [kg/km]	45.0
Nom. outer diameter [mm]	6.9
Nom. wire diameter [AWG]	23
ELECTRICAL CHARACTERISTICS @ 20°C	
Max. DC Resistance [Ω /km]	95.0
Nom. Mutual Capacity @1kHz [nF/km]	56
NVP [%]	70
Mean input Impedance [Ω]	100 \pm 5 @ 100MHz
Propagation delay @10MHz [ns]	max. 518
Delay Skew [ns/100m]	max. 40
Segregation class	c
Max. operating voltage [V DC]	80
Max. DC intensity per conductor [A/mm ²]	3.3
ENVIRONMENTAL CHARACTERISTICS	
Jacket material	LSZH
Flammability	Acc. to IEC 60332-1-2; IEC 60754-1/2; IEC 61034-1/2
Calorific value [MJ/m]	0.868

Frequency [MHz]	Max. attenuation [dB/100 m]	NEXT	PS-NEXT	ACR-F	PS-ACR-F	ACR	PS-ACR	Return loss [dB]
		[dB/100 m] min						
1*	2.1	75.3	72.3	68.0	65.0	73.2	70.2	20.0
4	3.8	66.3	63.3	58.0	55.0	62.5	59.5	23.0
8	5.2	61.8	58.8	51.9	48.9	56.5	53.5	24.5
10	5.9	60.3	57.3	50.0	47.0	54.4	51.4	25.0
16	7.4	57.2	54.2	45.9	42.9	49.9	46.9	25.0
25	9.2	54.3	51.3	42.0	39.0	45.0	42.0	24.3
31.25	10.3	52.9	49.9	40.1	37.1	42.6	39.6	23.6
62.5	14.5	48.4	45.4	34.1	31.1	33.8	30.8	21.5
100	18.4	45.3	42.3	30.0	27.0	26.9	23.9	20.1
155	22.9	42.4	39.4	26.2	23.2	19.5	16.5	18.8
200	26.1	40.8	37.8	24.0	21.0	14.7	11.7	18.0
250	29.2	39.3	36.3	22.0	19.0	10.1	7.1	17.3
300*	32.0	38.1	35.1	20.5	17.5	6.1	3.1	17.3
350*	34.7	37.1	34.1	19.1	16.1	2.5	1.0	17.3

Twisted pair Installation Cables

- ### Applications
- 10BASE-T (IEEE 802.3)
 - 100BASE-T (IEEE 802.3)
 - 1000BASE-T (Gigabit Ethernet)
 - 100BASE-VG-AnyLAN
 - 100 Mbps TP-PMD (ANSI X3T9.5)
 - 4/16 Mbps TOKEN RING (IEEE 802.5) 55/155 Mbps ATM

Standards

- ISO/IEC 11801
- EN 50173
- IEC 61156-5
- EN 50288-2-1
- IEC 60332-1-2
- IEC 60754-1/2
- IEC 61034-1/2

Construction

- Conductor (wire) - 23 AWG (0.574 mm)
- Insulation: polyolefin
- Pair number: 4 twisted pairs
- Jacket: blue LSZH in accordance with IEC 60322-1
- Shield - aluminium foil/polyester around all pairs
- Grounding: galvanized copper wire Φ 0.4 mm

TEMPERATURE CHARACTERISTICS

Storage Temperature [°C]	-20 to +70
Operating Temperature [°C]	-20 to +70
During installation [°C]	-5° to +50

*for information

U/FTP Cat.6 450 MHz

Quick 6



Copper cabling

Cable construction

1. Insulation
2. Drain wire
3. Conductor
4. Aluminium foil
5. Jacket

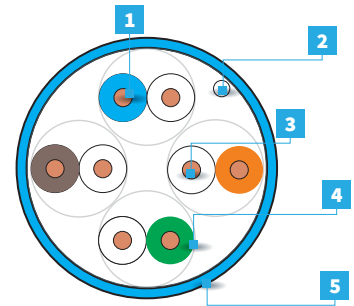

FIBRAINDATA Quick U/FTP Cat.6 Jacket LSZH 450 MHz	
500 m drum	XQ100.126
1000 m drum	XQ100.127
JACKET - LSZH BLUE	

MECHANICAL CHARACTERISTICS	
Min. bending radius in operation [mm]	30
Min. bending radius during installation [mm]	60
Max. pulling tension [N]	95
Nominal weight [kg/km]	51.0
Nom. outer diameter [mm]	7.4
Nom. wire diameter [AWG]	23
ELECTRICAL CHARACTERISTICS @ 20°C	
Max. DC Resistance [Ω/km]	95.0
Nom. Mutual Capacity @1kHz [nF/km]	56
NVP [%]	74
Mean input Impedance [Ω]	100 ± 5 @ 100MHz
Propagation delay @10MHz [ns]	max. 518
Delay Skew [ns/100m]	max. 40
Segregation class	c
Max. operating voltage [V DC]	80
Max. DC intensity per conductor [A/mm ²]	3.3
ENVIRONMENTAL CHARACTERISTICS	
Jacket material	LSZH
Flammability	Acc. to IEC 60332-1-2, IEC 60754-1/2; IEC 61034-1/2
Calorific value [MJ/m]	0.687

Frequency [MHz]	Max. attenuation [dB/100 m]	NEXT	PS-NEXT	ACR-F	PS-ACR-F	ACR	PS-ACR	Return loss [dB]
		[dB/100 m] min						
1	2.0	75.3	72.3	68.0	65.0	73.2	70.2	20.0
4	3.8	66.3	63.3	58.0	55.0	62.5	59.5	23.0
8	5.2	61.8	58.8	51.9	48.9	56.5	53.5	24.5
10	5.9	60.3	57.3	50.0	47.0	54.4	51.4	25.0
16	7.4	57.2	54.2	45.9	42.9	49.9	46.9	25.0
25	9.2	54.3	51.3	42.0	39.0	45.0	42.0	24.3
31.25	10.3	52.9	49.9	40.1	37.1	42.6	39.6	23.6
62.5	14.5	48.4	45.4	34.1	31.1	33.8	30.8	21.5
100	18.4	45.3	42.3	30.0	27.0	26.9	23.9	20.1
155	22.9	42.4	39.4	26.2	23.2	19.5	16.5	18.8
200	26.1	40.8	37.8	24.0	21.0	14.7	11.7	18.0
250	29.2	39.3	36.3	22.0	19.0	10.1	7.1	17.3
300*	32.0	38.1	35.1	20.5	17.5	6.1	3.1	17.3
350*	34.7	37.1	34.1	19.1	16.1	2.5	1.0	17.3
450*	39.5	35.5	32.5	16.9	13.9	1.0	---	16.0

*for information only

- #### Applications
- 10BASE-T (IEEE 802.3)
 - 100BASE-T (IEEE 802.3)
 - 1000BASE-T (Gigabit Ethernet)
 - 100BASE-VG-AnyLAN
 - 100 Mbps TP-PMD (ANSI X3T9.5)
 - 4/16 Mbps TOKEN RING (IEEE 802.5) 55/155 Mbps ATM

- #### Standards
- ISO/IEC 11801
 - EN 50173
 - IEC 61156-5
 - EN 50288-3-1
 - IEC 60332-1-2
 - IEC 60754-1/2
 - IEC 61034-1/2

- #### Construction
- Conductor (wire) - 23 AWG (0.574 mm)
 - Insulation: polyolefin
 - Pair number: 4 twisted pairs
 - Jacket: blue LSZH in accordance with IEC 60322-1
 - Shield: aluminium/polyester foil around each pair
 - Grounding: galvanized copper wire Ø0.4 mm

TEMPERATURE CHARACTERISTICS	
Storage Temperature [°C]	-20 to +70
Operating Temperature [°C]	-20 to +70
During installation [°C]	-5° to +50

F/FTP Cat.6 450 MHz

Quick 6



Cable construction

1. Insulation
2. Drain wire
3. Conductor
4. Aluminium foil
5. Jacket

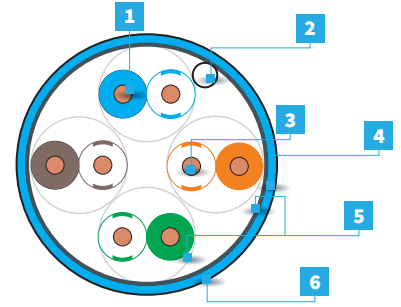

FIBRAINDATA Quick F/FTP Cat.6 Jacket LSZH 450 MHz	
500 m drum	XQ100.136
1000 m drum	XQ100.137
JACKET - LSZH BLUE	

MECHANICAL CHARACTERISTICS	
Min. bending radius in operation [mm]	30
Min. bending radius during installation [mm]	60
Max. pulling tension [N]	95
Nominal weight [kg/km]	53.4
Nom. outer diameter [mm]	7.5
Nom. wire diameter [AWG]	23
ELECTRICAL CHARACTERISTICS @ 20°C	
Max. DC Resistance [Ω /km]	95.0
Nom. Mutual Capacity @1kHz [nF/km]	56
NVP [%]	74
Mean input Impedance [Ω]	100 \pm 5 @ 100MHz
Propagation delay @10MHz [ns]	max. 518
Delay Skew [ns/100m]	max. 40
Segregation class	c
Max. operating voltage [V DC]	80
Max. DC intensity per conductor [A/mm ²]	3.3
ENVIRONMENTAL CHARACTERISTICS	
Jacket material	LSZH
Flammability	Acc. to IEC 60332-1-2, IEC 60754-1/2; IEC 61034-1/2
Calorific value [MJ/m]	0.696

Frequency [MHz]	Max. attenuation [dB/100 m]	NEXT	PS-NEXT	ACR-F	PS-ACR-F	ACR	PS-ACR	Return loss [dB]
		[dB/100 m] min						
1	2.1	75.3	72.3	68.0	65.0	73.2	70.2	20.0
4	3.8	66.3	63.3	58.0	55.0	62.5	59.5	23.0
8	5.2	61.8	58.8	51.9	48.9	56.5	53.5	24.5
10	5.9	60.3	57.3	50.0	47.0	54.4	51.4	25.0
16	7.4	57.2	54.2	45.9	42.9	49.9	46.9	25.0
25	9.2	54.3	51.3	42.0	39.0	45.0	42.0	24.3
31.25	10.3	52.9	49.9	40.1	37.1	42.6	39.6	23.6
62.5	14.5	48.4	45.4	34.1	31.1	33.8	30.8	21.5
100	18.4	45.3	42.3	30.0	27.0	26.9	23.9	20.1
155	22.9	42.4	39.4	26.2	23.2	19.5	16.5	18.8
200	26.1	40.8	37.8	24.0	21.0	14.7	11.7	18.0
250	29.2	39.3	36.3	22.0	19.0	10.1	7.1	17.3
300*	32.0	38.1	35.1	20.5	17.5	6.1	3.1	17.3
350*	34.7	37.1	34.1	19.1	16.1	2.5	1.0	17.3
450*	39.5	35.5	32.5	16.9	13.9	1.0	---	16.0

- ### Applications
- 10BASE-T (IEEE 802.3)
 - 100BASE-T (IEEE 802.3)
 - 1000BASE-T (Gigabit Ethernet)
 - 100BASE-VG-AnyLAN
 - 100 Mbps TP-PMD (ANSI X3T9.5)
 - 4/16 Mbps TOKEN RING (IEEE 802.5) 55/155 Mbps ATM

- ### Standards
- ISO/IEC 11801
 - EN 50173
 - IEC 61156-5
 - EN 50288-3-1
 - IEC 60332-1-2
 - IEC 60754-1/2
 - IEC 61034-1/2

- ### Construction
- Conductor (wire) - 23 AWG (0.574 mm)
 - Insulation: polyolefin
 - Pair number: 4 twisted pairs
 - Jacket: blue LSZH in accordance with IEC 60322-1
 - Shield: aluminium/polyester foil around each pair
 - Shield: aluminium/polyester foil around all pairs
 - Grounding: galvanized copper wire Φ 0.4 mm

TEMPERATURE CHARACTERISTICS	
Storage Temperature [°C]	-20 to +70
Operating Temperature [°C]	-20 to +70
During installation [°C]	-5° to +50

*for information only

F/UTP Cat.6_A 500 MHz

Rapid 6a



Cable construction

1. Insulation
2. Conductor
3. Shield
4. Drain wire
5. Cross web
6. Jacket

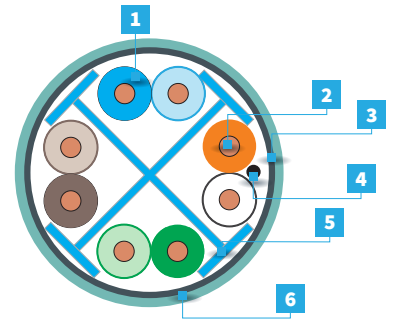

FIBRAINDATA Rapid F/UTP Cat.6 _A Jacket LSZH 500 MHz	
500 m drum	XR100.116
1000 m drum	XR100.117
JACKET - LSZH AQUA	

MECHANICAL CHARACTERISTICS	
Min. bending radius in operation [mm]	35
Min. bending radius during installation [mm]	65
Max. pulling tension [N]	90
Nominal weight [kg/km]	52.6
Nom. outer diameter [mm]	7.6
Nom. wire diameter [AWG]	23

ELECTRICAL CHARACTERISTICS @ 20°C	
Max. DC Resistance [Ω/km]	95.0
Nom. Mutual Capacity @1kHz [nF/km]	56
NVP [%]	72
Mean input Impedance [Ω]	100 ± 5 @ 100MHz
Propagation delay @10MHz [ns]	max. 518
Delay Skew [ns/100m]	max. 40
Segregation class	c
Max. operating voltage [V DC]	80
Max. DC intensity per conductor [A/mm ²]	3.3

ENVIRONMENTAL CHARACTERISTICS	
Jacket material	LSZH
Flammability	Acc. to IEC 60332-1-2; IEC 60754-1/2; IEC 61034-1/2
Calorific value [MJ/m]	0.717

Frequency [MHz]	Max. attenuation [dB/100 m]	NEXT	PS-NEXT	ACR-F	PS-ACR-F	ACR	PS-ACR	Return loss [dB]
		[dB/100 m] min						
1*	2.1	75.3	72.3	68.0	65.0	73.2	70.2	20.0
4	3.8	66.3	63.3	56.0	53.0	62.5	59.5	23.0
8	5.3	61.8	58.8	69.9	46.9	56.4	53.4	24.5
10	5.9	60.3	57.3	48.0	45.0	54.4	51.4	25.0
16	7.5	57.2	54.2	43.9	40.9	49.8	46.8	25.0
25	9.4	54.3	51.3	40.0	37.0	45.0	42.0	24.3
31.25	10.5	52.9	49.9	38.1	35.1	42.4	39.4	23.6
62.5	15.0	48.4	45.4	32.1	29.1	33.4	30.4	21.5
100	19.0	45.3	42.3	28.0	25.0	26.2	23.2	20.1
155	24.1	42.4	39.4	24.2	21.2	18.4	15.4	18.8
200	27.6	40.8	37.8	22.0	19.0	13.2	10.2	18.0
250	31.1	39.3	36.3	20.0	17.0	8.3	5.3	17.3
300	34.3	38.1	35.1	18.5	15.5	3.9	0.9	17.3
350	37.2	37.1	34.1	17.1	14.1	---	---	17.3
400	40.1	36.3	33.3	16.0	---	---	---	17.3
500	45.3	34.8	31.8	14.0	---	---	---	17.3

Copper cabling

Applications

- 10BASE-T (IEEE 802.3)
- 100BASE-T (IEEE 802.3)
- 1000BASE-T (Gigabit Ethernet)
- 10GBASE-T (10Gigabit Ethernet)
- 100 Mbps TP-PMD (ANSI X3T9.5)
- 4/16 Mbps TOKEN RING (IEEE 802.5) 55/155 Mbps ATM

Standards

- ISO/IEC 11801
- EN 50173
- IEC 61156-5
- EN 50288-2-1
- IEC 60332-1-2
- IEC 60754-1/2
- IEC 61034-1/2

Construction

- Conductor (wire) - 23 AWG (0.574 mm)
- Insulation: polyolefin
- Pair number: 4 twisted pairs
- Jacket: LSZH aqua in accordance with IEC 60322-1
- Shield: Aluminium foil/polyester around all pairs
- Grounding: galvanized copper wire Ø0.4 mm

TEMPERATURE CHARACTERISTICS [°C]

Storage	-20° to +70°
Operating	-20° to +70°
During installation	-5° to +50°

*for information only

U/FTP Cat.6_A 500 MHz

Rapid 6a

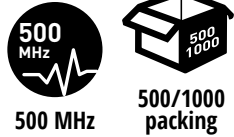

Cable construction

1. Insulation
2. Drain wire
3. Conductor
4. Aluminium foil
5. Jacket

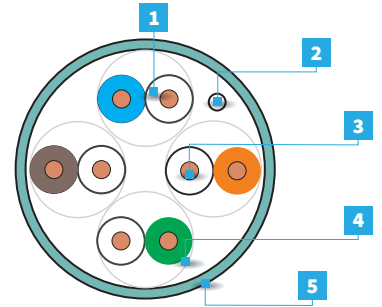

FIBRAINDATA Rapid U/FTP Cat.6 _A Jacket LSZH 500 MHz	
500 m reel	XR100.126
1000 m reel	XR100.127
JACKET - LSZH AQUA	

MECHANICAL CHARACTERISTICS	
Min. bending radius in operation [mm]	30
Min. bending radius during installation [mm]	60
Max. pulling tension [N]	95
Nominal weight [kg/km]	51.0
Nom. outer diameter [mm]	7.4
Nom. wire diameter [AWG]	23
ELECTRICAL CHARACTERISTICS @ 20°C	
Max. DC Resistance [Ω/km]	95.0
Nom. Mutual Capacity @1kHz [nF/km]	56
NVP [%]	74
Mean input Impedance [Ω]	100 ± 5 @ 100MHz
Propagation delay @10MHz [ns]	max. 518
Delay Skew [ns/100m]	max. 40
Segregation class	c
Max. operating voltage [V DC]	80
Max. DC intensity per conductor [A/mm ²]	3.3
ENVIRONMENTAL CHARACTERISTICS	
Jacket material	LSZH
Flammability	Acc. to IEC 60332-1-2; IEC 60754-1/2; IEC 61034-1/2
Caloric value [MJ/m]	0.687

Frequency [MHz]	Max. attenuation [dB/100 m]	NEXT	PS-NEXT	ACR-F	PS-ACR-F	ACR	PS-ACR	Return loss [dB]
		[dB/100 m] min						
1	2.0	75.3	72.3	68.0	65.0	73.2	70.2	20.0
4	3.8	66.3	63.3	58.0	55.0	62.5	59.5	23.0
8	5.2	61.8	58.8	51.9	48.9	56.5	53.5	24.5
10	5.9	60.3	57.3	50.0	47.0	54.4	51.4	25.0
16	7.4	57.2	54.2	45.9	42.9	49.9	46.9	25.0
25	9.2	54.3	51.3	42.0	39.0	45.0	42.0	24.3
31.25	10.3	52.9	49.9	40.1	37.1	42.6	39.6	23.6
62.5	14.5	48.4	45.4	34.1	31.1	33.8	30.8	21.5
100	18.4	45.3	42.3	30.0	27.0	26.9	23.9	20.1
155	22.9	42.4	39.4	26.2	23.2	19.5	16.5	18.8
200	26.1	40.8	37.8	24.0	21.0	14.7	11.7	18.0
250	29.2	39.3	36.3	22.0	19.0	10.1	7.1	17.3
300*	32.0	38.1	35.1	20.5	17.5	6.1	3.1	17.3
350*	34.7	37.1	34.1	19.1	16.1	2.5	1.0	17.3
450*	39.5	35.5	32.5	16.9	13.9	1.0	---	16.0

*for information only

Applications

- 10BASE-T (IEEE 802.3)
- 100BASE-T (IEEE 802.3)
- 1000BASE-T (Gigabit Ethernet)
- 100BASE-VG-AnyLAN
- 100 Mbps TP-PMD (ANSI X3T9.5)
- 4/16 Mbps TOKEN RING (IEEE 802.5) 55/155 Mbps ATM

Standards

- ISO/IEC 11801
- EN 50173
- IEC 61156-5
- EN 50288-3-1
- IEC 60332-1-2
- IEC 60754-1/2
- IEC 61034-1/2

Construction

- Conductor (wire) - 23 AWG (0.574 mm)
- Insulation: polyolefin
- Pair number: 4 twisted pairs
- Jacket: LSZH aqua in accordance with IEC 60332-1
- Shield: aluminium/polyester foil around each pair
- Grounding: galvanized copper wire Ø0.4 mm

TEMPERATURE CHARACTERISTICS	
Storage Temperature [°C]	-20 to +70
Operating Temperature [°C]	-20 to +70
During installation [°C]	-5° to +50

S/FTP Cat.6_A 500 MHz

Rapid 6a

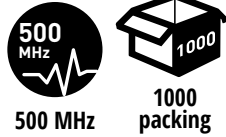

Cable construction

1. Insulation
2. Drain wire
3. Conductor
4. Aluminium foil
5. Braid
6. Jacket

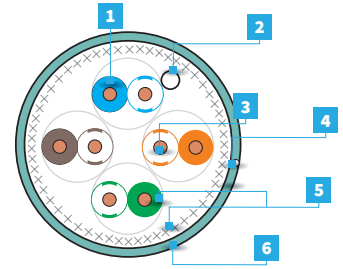

1000 m drum	XR100F147
JACKET - FR-LSZH AQUA (RAL 6027)	

MECHANICAL CHARACTERISTICS	
Min. bending radius in operation [mm]	30
Min. bending radius during installation [mm]	60
Max. pulling tension [N]	110
Nominal weight [kg/km]	60
Nom. outer diameter [mm]	7.6
Nom. wire diameter [AWG]	23
ELECTRICAL CHARACTERISTICS @ 20°C	
Max. DC Resistance [Ω/km]	95
Nom. Mutual Capacity @1kHz [nF/km]	45
NVP [%]	80
Mean input Impedance [Ω]	100 ± 5 @ 100MHz
Segregation class	d
Coupling attenuation [dB]	Min.80
ENVIRONMENTAL CHARACTERISTICS	
Jacket material	LSFRZH
Flammability	Acc. to IEC 60332-3-24, IEC 60754-1/2; IEC 61034-1/2
Calorific value [MJ/m]	0.62

Frequency [MHz]	Max. attenuation [dB/100 m]	NEXT				Return loss [dB]
		NEXT	PS-NEXT	ACR-F	PS-ACR-F	
		[dB/100 m] min				
4	3.6	100	100	91.2	88.2	28.0
16	7.2	100	100	89.4	86.4	30.0
20	8.0	100	100	89.0	86.0	30.0
31.25	10.0	100	100	88.0	85.0	28.6
62.5	14.2	100	97.5	85.9	82.9	26.5
100	18.1	97.4	94.4	84.0	81.0	25.1
155	22.7	94.5	91.5	81.7	78.7	23.8
200	25.8	92.9	89.9	80.1	77.1	23.0
240	29	91.7	88.7	78.5	75.8	22.4
250	31.9	91.4	88.4	75.7	75.5	22.3
350	34.6	89.2	86.2	75.7	72.7	22.3
500	41.8	86.9	83.9	72.1	69.1	22.3

*for information only

Applications

- 10BASE-T (IEEE 802.3)
- 100BASE-T (IEEE 802.3)
- 1000BASE-T (Gigabit Ethernet)
- 10GBASE-T (10Gigabit Ethernet)
- Power Over Ethernet

Standards

- LSZH: PN-EN 61034, PN-EN 50267-2-1
- PN-EN 60332-1, PN-EN 60332-3-24
- ANSI/TIA/EIA 568-C.2 (Cat.6A)
- ISO/IEC 11801:2011
- PN-EN 50173:2011

Construction

- Conductor (wire) - 23 AWG (0.574 mm)
- Insulation: polyolefin
- Pair number: 4 twisted pairs
- Jacket: LSZH aqua in accordance with IEC 60322-1
- Jacket: FR-LSZH aqua
- Shield: aluminium/polyester foil around each pair
- Shield: Braid around all pairs
- Grounding: galvanized copper wire Ø0.4 mm

TEMPERATURE CHARACTERISTICS [°C]	
Storage	-20° to +70°
Operating	-20° to +70°
During installation	0° to +50°

S/FTP Cat.7 900 MHz

ULTRA 7



Cable construction

1. Insulation
2. Drain wire
3. Conductor
4. Aluminium foil
5. Braid
6. Jacket

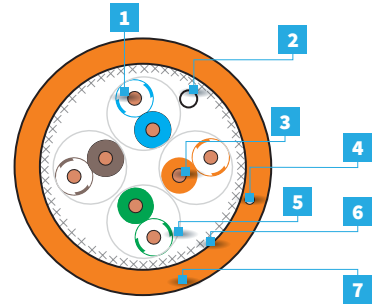

1000 m drum	X9U100F147
	JACKET - FR-LSZH ORANGE

MECHANICAL CHARACTERISTICS						
Min. bending radius in operation [mm]	30					
Min. bending radius during installation [mm]	60					
Max. pulling tension [N]	120					
Nominal weight [kg/km]	61					
Nom. outer diameter [mm]	7.6					
Nom. wire diameter [AWG]	23					
ELECTRICAL CHARACTERISTICS @ 20°C						
Max. DC Resistance [Ω/km]	95					
Nom. Mutual Capacity @1kHz [nF/km]	45					
NVP [%]	80					
Mean input Impedance [Ω]	100 ± 5 @ 100MHz					
Segregation class	d					
Coupling attenuation [dB]	Min.80					
ENVIRONMENTAL CHARACTERISTICS						
Jacket material	FR-LSZH					
Flammability	Acc. to IEC 60332-3-24, IEC 60754-1/2; IEC 61034-1/2					
Calorific value [MJ/m]	0.62					
Frequency [MHz]	Max. attenuation [dB/100 m]	NEXT	PS-NEXT	ACR-F	PS-ACR-F	Return loss [dB]
		[dB/100 m] min				
4	3.6	100	100	100	98.2	33.0
100	18.1	97.4	94.4	94.0	91.0	30.1
155	22.7	94.5	91.5	91.7	88.7	28.8
200	25.8	92.9	89.9	90.1	87.1	28.0
240	28.4	91.7	88.7	88.5	85.8	27.4
250	29.0	91.4	88.4	85.7	85.5	27.3
350	34.6	89.2	86.2	85.7	82.7	26.3
500	41.8	86.9	83.9	82.1	79.1	25.3
550	43.9	86.3	83.3	81.0	78.0	25.3
580	45.2	85.9	82.9	80.4	77.4	25.3
590	45.6	85.8	82.8	80.2	77.2	25.3
600	46.0	85.7	82.7	80.0	77.0	25.3

*for information only

Applications

- 10BASE-T (IEEE 802.3)
- 100BASE-T (IEEE 802.3)
- 1000BASE-T (Gigabit Ethernet)
- 10GBASE-T (10Gigabit Ethernet)
- Power Over Ethernet

Standards

- ISO/IEC 11801
- EN 50173
- IEC 61156-5
- EN 50288-3-1
- IEC 60332-3-24
- IEC 60754-1/2
- IEC 61034-1/2

Construction

- Conductor (wire) - 23 AWG (0.574mm)
- Insulation: polyolefin
- Pair number: 4 twisted pairs
- Jacket: LSZH orange in accordance with IEC 60322-1
- Jacket: FR-LSZH orange
- Shield: aluminium/polyester foil around each pair
- Shield: Braid around all pairs
- Grounding: galvanized copper wire Φ 0.4 mm

TEMPERATURE CHARACTERISTICS	
Storage Temperature [°C]	-20 to +70
Operating Temperature [°C]	-20 to +70
During installation [°C]	0° to +50

S/FTP Cat.7_A 1200 MHz

ULTRA 7A

Copper cabling

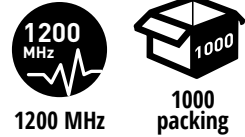

Cable construction

1. Insulation
2. Drain wire
3. Conductor
4. Aluminium foil
5. Braid
6. Jacket

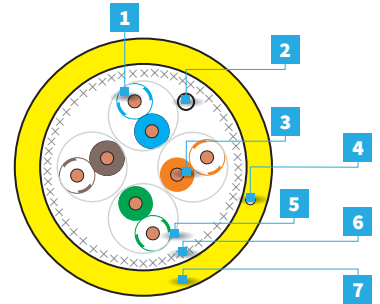

1000 m drum	XUA100F146
	JACKET - FR-LSZH YELLOW

MECHANICAL CHARACTERISTICS	
Min. bending radius in operation [mm]	32
Min. bending radius during installation [mm]	64
Max. pulling tension [N]	142
Nominal weight [kg/km]	68
Nom. outer diameter [mm]	7.9
Nom. wire diameter [AWG]	23
ELECTRICAL CHARACTERISTICS @ 20°C	
Max. DC Resistance [Ω/km]	95.0
Nom. Mutual Capacity @1kHz [nF/km]	45
NVP [%]	82
Mean input Impedance [Ω]	100 ± 5 @ 100MHz
Segregation class	d
Coupling attenuation [dB]	min. 85

ENVIRONMENTAL CHARACTERISTICS	
Jacket material	LSFRZH
Flammability	Acc. to IEC 60332-3-24, IEC 60754-1/2; IEC 61034-1/2
Calorific value [MJ/m]	0.76

Frequency [MHz]	Max. attenuation [dB/100 m]	NEXT	PS-NEXT	ACR-F	PS-ACR-F	RL
		[dB/100 m] min				
4	3.5	105.0	105.0	90.0	87.2	28.0
100	16.9	100.4	97.4	79.1	76.1	25.1
250	27.1	94.4	91.4	66.4	67.7	22.3
500	39.0	89.9	86.9	60.9	57.9	22.3
590	42.5	88.8	85.8	58.0	55.3	22.3
600	42.9	88.7	85.7	57.7	54.7	22.3
700	46.5	87.4	84.4	54.7	51.7	21.6
800	49.9	86.2	83.2	51.8	48.8	21.1
900	53.2	85.2	82.2	49.1	46.1	20.5
1000	56.3	84.3	81.3	46.6	43.6	20.1

Applications

- 10BASE-T (IEEE 802.3)
- 100BASE-T (IEEE 802.3)
- 1000BASE-T (Gigabit Ethernet)
- 10GBASE-T (10Gigabit Ethernet)
- Power Over Ethernet

Standards

- ISO/IEC 11801
- EN 50173
- IEC 61156-5
- EN 50288-3-1
- IEC 60332-3-24
- IEC 60754-1/2
- IEC 61034-1/2

Construction

- Conductor (wire) - 23 AWG (0.574 mm)
- Insulation: polyolefin
- Pair number: 4 twisted pairs
- Jacket: LSZH yellow in accordance with IEC 60322-1
- Jacket: FR-LSZH yellow
- Shield: aluminium/polyester foil around each pair
- Shield: Braid around all pairs
- Grounding: galvanized copper wire Φ 0.4 mm

U/UTP Cat.3 25 pairs 25 MHz

Voice

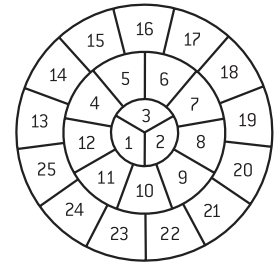
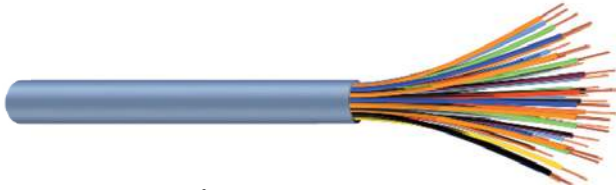

25 pairs Jacket PVC or LSZH U/UTP cable Cat.3 25 MHz		
1000 m drum	XV125.103	XV125.107
	JACKET - PVC GREY	JACKET - LSZH GREEN

ELECTRICAL AND CONSTRUCTION PARAMETERS		
Resistance (max) ohm/100 m(328 ft) @ 20 °C		8.90
Minimum dielectric strength between conductors (min) [V]		1000
Insulation strength (min) [MΩm*km]		20000
Impedence characteristic [Ohm] (min-max)		
values at	772 kHz	87-117
	1.0 - 16 MHz	85-115
Return loss (RL) dB (min)		
values at	772 kHz	12
	1.0 - 16 MHz	12-log(f/10)
Construction		25x2x0.5
Diameter [mm]		10.4
Weight [kg/km]		162
Drum size		08

Frequency [MHz]	Max. attenuation [dB/100 m]	NEXT [dB/100 m] min
0.772	1.8	72.0
1	2.1	70.3
4	4.0	61.3
10	6.2	55.3
16	7.9	52.2
25	10.0	49.3

Applications

- PBX
- Point-to-Point
- Token Ring4 Mbit/s
- ATM LAN 51.84 Mbit/s
- ATM LAN 155.52 Mbit/s
- Analog and digital transmission of phone signals

Standards

- LSZH: PN-EN 61034, PN-EN 50267-2-1
- PN-EN 60332-1
- ANSI/TIA/EIA 568-C.2 (Cat.3)
- ISO/IEC 11801
- EN 50173, EN 50288

Construction

- Conductor (wire) - 24 AWG (0.51 mm)
- Insulation - polyolefin
- Pair number -25 twisted pairs
- Jacket - XV125.103 - PVC - grey
- Jacket - XV125.107 - LSZH - green

U/UTP Cat.3 50 pairs 25 MHz

Voice

Copper cabling

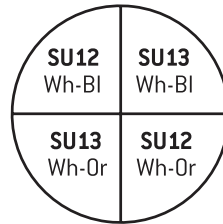
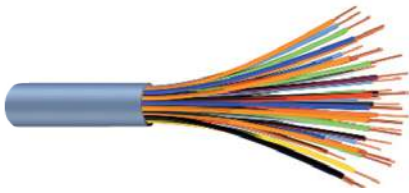

Subunit kolor:
Wh-BI (White-Blue)
Wh-Or (White-Orange)

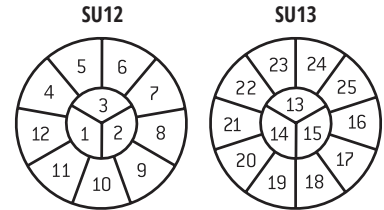

50 pairs Jacket PVC or LSZH U/UTP Cat.3 cable 25 MHz		
1000 m drum	XV150.103	XV150.107
	JACKET - PVC GREY	JACKET - LSZH GREEN

ELECTRICAL AND CONSTRUCTION PARAMETERS		
Resistance (max) ohm/100 m(328 ft) @ 20 °C		8.90
Minimum dielectric strength between conductors (min) [V]		1000
Insulation strength (min) [MΩm*km]		20000
Impedence characteristic [Ohm]		(min-max)
values at	772 kHz	87-117
	1.0 - 16 MHz	85-115
Return loss (RL) dB (min)		
values at	772 kHz	12
	1.0 - 16 MHz	12-log(f/10)
Construction		50x2x0.5
Diameter [mm]		13.8
Weight [kg/km]		293
Drum size		10

Frequency [MHz]	Max. attenuation [dB/100 m]	NEXT [dB/100 m] min
0.772	1.8	72.0
1	2.1	70.3
4	4.0	61.3
10	6.2	55.3
16	7.9	52.2
25	10.0	49.3

Applications

- PBX
- Point-to-Point
- Token Ring 4 Mbit/s
- ATM LAN 51.84 Mbit/s
- ATM LAN 155.52 Mbit/s
- Analog and digital transmission of phone signals

Standards

- LSZH: PN-EN 61034, PN-EN 50267-2-1
- PN-EN 60332-1
- ANSI/TIA/EIA 568-C.2 (Cat.3)
- ISO/IEC 11801
- EN 50173, EN 50288

Construction

- Conductor (wire) - 24 AWG (0.51 mm)
- Insulation - polyolefin
- Pair number -50 twisted pairs
- Jacket - XV150.103 - PVC - grey
- Jacket - XV150.107 - LSZH - green

U/UTP Cat.3 100 pairs 25 MHz

Voice

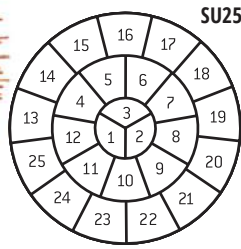

Subunit kolor:
Wh-BI (White-Blue)
Wh-Or (White-Orange)
Wh-Gr (White-Green)
WH-Br (White-Brown)

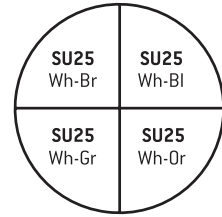

100 pairs Jacket PVC or LSZH U/UTP Cat.3 cable 25 MHz		
1000 m drum	XV100.103	XV100.107
	JACKET - PVC GREY	JACKET - LSZH GREEN

ELECTRICAL AND CONSTRUCTION PARAMETERS		
Resistance (max) ohm/100 m(328 ft) @ 20 °C		89.5
Minimum dielectric strength between conductors (min) [V]		1000
Insulation strength (min) [MΩm*km]		20000
Impedence characteristic [Ohm]		(min-max)
values at	772 kHz	87-117
	1.0 - 16 MHz	85-115
Return loss (RL) dB (min)		
values at	1.0 - 10 MHz	12
	10 - 20 MHz	12-log(f/10)
Construction		100x2x0.5
Diameter [mm]		19.1
Weight [kg/km]		560
Drum size		12

Frequency [MHz]	Max. attenuation [dB/100 m]	NEXT [dB/100 m] min
0.772	1.8	72.0
1	2.1	70.3
4	4.0	61.3
10	6.2	55.3
16	7.9	52.2
25	10.0	49.3

Applications

- PBX
- Point-to-Point
- Token Ring4 Mbit/s
- ATM LAN 51.84 Mbit/s
- ATM LAN 155.52 Mbit/s
- Analog and digital transmission of phone signals

Standards

- LSZH: PN-EN 61034, PN-EN 50267-2-1
- PN-EN 60332-1
- ANSI/TIA/EIA 568-C.2 (Cat.3)
- ISO/IEC 11801
- EN 50173, EN 50288

Construction

- Conductor (wire) - 24 AWG (0.51 mm)
- Insulation - polyolefin
- Pair number -100 twisted pairs
- Jacket - XV100.103 - PVC - grey
- Jacket - XV100.107 - LSZH - green

U/UTP Cat.5e 25 pairs

100 MHz Express 5e



Copper cabling

Cable construction

1. Conductor
2. Insulation
3. Cable core
4. Braid
5. Jacket

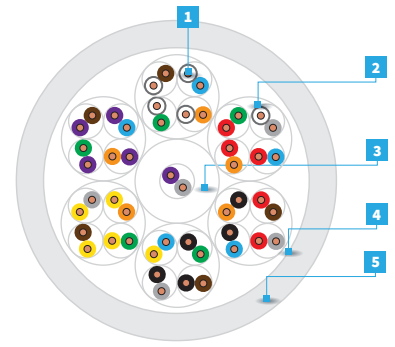

FIBRAINDATA Express 25xU/UTP Cat.5e+ 100 MHz		
1000 m drum	XE125.103	XE125.107
	JACKET - PVC GREY	JACKET - LSZH GREEN

ELECTRICAL AND CONSTRUCTION PARAMETERS		
Resistance (max) Ohm/100 m(328 ft) @ 20 °C		8.90
Mutual capacitance (max) nF/100 m(328 ft) @ 1 kHz		5.20
Nominal velocity of propagation NVP (% speed of light)		68
Impedence characteristic [Ohm]		(min-max)
values at	772 kHz	87 - 117
	1.0 - 200 MHz	85 - 115
Return loss (RL) dB (min)		
values at	1.0 - 10 MHz	20+5 log(f)
	10 - 20 MHz	25
	20 - 100 MHz	25-7 log(f/20)
Propagation delay (max) [ns @ 10 MHz]		518
Delay skew (max) [ns/100 m]		40
Diameter [mm]		13.5
Weight [kg/km]		205
Minimal bending radius [mm]		55
Installation temperature [°C]		-20/+70
Operating temperature [°C]		-20/+70

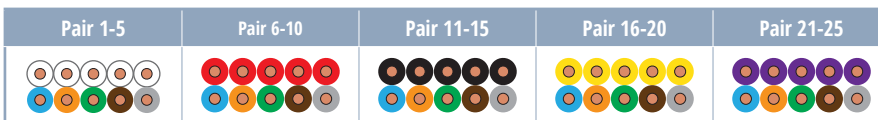

Frequency [MHz]	Max. attenuation [dB/100 m]	NEXT	PS-NEXT	ACR-F	PS-ACR-F	Return loss [dB]
		[dB/100 m] min				
1	2.0	65.3	62.3	61.0	58.0	20.0
4	4.1	56.3	53.3	49.0	46.0	23.0
8	5.8	51.3	48.3	42.0	39.9	24.5
10	6.5	50.3	47.3	41.0	38.0	25.0
16	8.2	47.3	44.3	36.9	33.9	25.0
20	9.3	45.3	42.3	34.9	31.9	25.0
25	10.4	44.3	41.3	33.0	30.0	24.3
31.25	11.7	42.9	39.9	31.0	28.0	23.6
62.5	17.0	38.4	35.4	25.1	22.1	21.5
100	22.0	35.3	32.3	21.0	18.0	20.1

Applications

- 10BASE-T (IEEE 802.3)
- 4/16 Mbps Token Ring (IEEE 802.5)
- 100BASE-VG-AnyLAN
- 100Mbps TP-PMD (ANSI X3T9.5)
- 100BASE-T (IEEE 802.3)
- 55/155 Mbps ATM
- 1000BASE-T (Gigabit Ethernet)

Standards

- PN-EN 60332-1
- ANSI/TIA/EIA 568-C.2 (Cat.5e)
- ISO/IEC 11801:2011
- IEC 61156-5
- PN-EN 50173, PN-EN 50288

Construction

- Conductor (wire) - 24 AWG (0.51 mm)
- Insulation - polyolefin
- Pair number - 25 twisted pairs
- Jacket - grey PVC
- Jacket - green LSZH

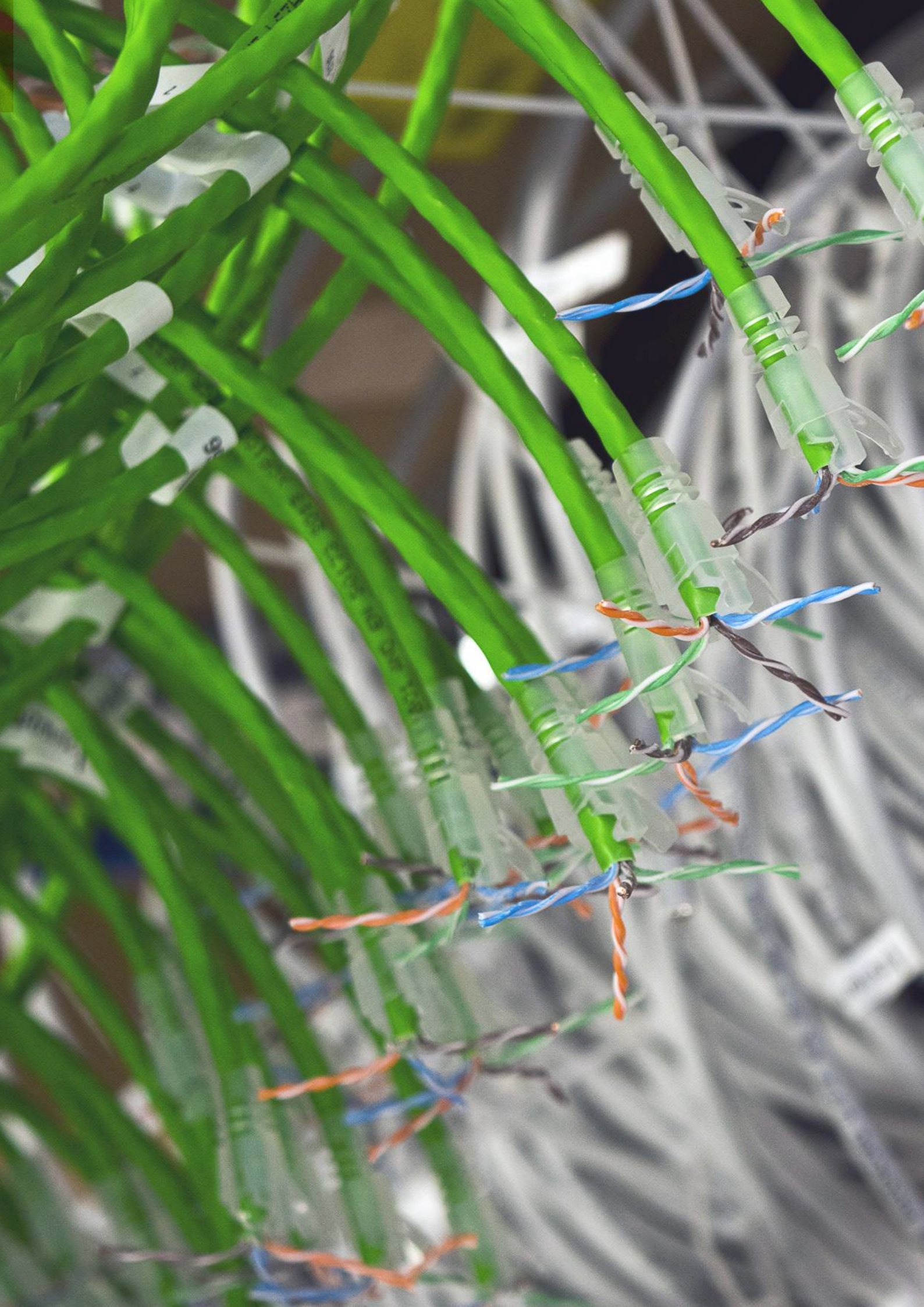

COPPER



FIBRAINDATA

FIBRAINDATA CONNECTORS

Safety systems and the highest protection



UNIVERSAL TOOL

Construction ensures termination of all conductors



RE-EMBEDDED PASS

Modules from cat. 6 and higher are verified with the use of Re-Embedded method - confirmed with 3P Third Part Test certificate



RJ45 CONNECTOR PROTECTION

Wire separator protecting the module against degradation



SMALL DIMENSIONS

Modules with small dimensions guarantee high density of packaging

CONNECTORS

against potential risks



**NON-SHIELDED
MODULES**



PAIR SEPARATION

Transmission pair separation system inside keystone module



**SHIELDED
MODULES**



FARADAY CAGE

One solid body ensures protection against outside disruptions



**PAIR SEPARATION ON IDC
CONNECTIONS**

Angular IDC connections placed at different angle compared to nearby pairs



**FIELD
TERMINABLE PLUG**



SCREENED CAT. 6_A PLUG



**SUPPORT FOR UP TO
10GBASE-T APPLICATION**



IP20

IP20 PROTECTION LEVEL



ANGULAR IDC CONNECTION

In each element we take care of dynamic parameters- angular connection reducing RL and NEXT



FIBRAIN PACKING

Modules are packed separately in Easy Open and clearly marked bags

Keystone module Cat.5e UTP

Copper cabling

Express 5e

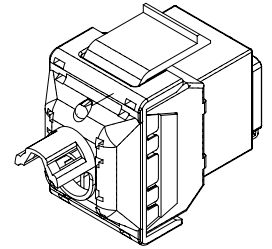
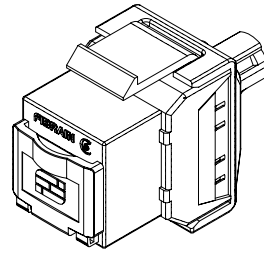

Keystone FIBRAINDATA Cat.5e UTP with green anti-dust cover

XE100.400

WITH GREEN ANTI-DUST COVER



Colorful cover



<1 min
installation time

ELECTRICAL AND MECHANICAL PARAMETERS

Compliance with the norm	ISO 11801 ed.2.2. EN 50173. TIA 568-C.2. IEC 60603-7-3
Operating temperature	-10 °C to 60 °C
Storage temperature	-40 °C to 70 °C
Connector class	Cat.5/Cat.6
Shielding	none
Housing material	UL-94-V0
Max. amperage [A]	1.5
Min. insulation resistance [MΩ]	500
Max DC resistance [Ω]	0.1
Contact material	Phosphor-bronze (CuSN)
Contacts	Min 0.75 µm gold layer, min. 1.3 µm nickel layer
IDC connector material	Phosphor-bronze (CuSN)
IDC covering	Min 1.27 µm silver layer, min. 2.5 µm nickel layer
Conductor diameter range (wire)	0.4 mm (AWG26) – 0.65 mm (AWG22)
Conductor diameter range (rope)	AWG26/7 – AWG22/7
Min. connection cycles qty	750
Min. module re-termination	20
Mounting	keystone

Features

- Tool-less
- Housing minimizes wires unbraiding
- Flame-retardant materials UL94V-0
- Anti-dust cover
- Sequence identification 568A and 568B

Standards

- "Keystone" standard ensures assembly compatibility
- Structured cabling standards ISO/IEC 11801:2011, EN 0173:2011, TIA/EIA568 - C.2
- Verification in accordance with the new standards by independent laboratory centres

Accessories

- **XB-DC-W-01** 25 pcs white anti-dust covers
- **XB-DC-Y-01** 25 pcs yellow anti-dust covers
- **XB-DC-R-01** 25 pcs red anti-dust covers
- **XB-DC-BK-01** 25 pcs black anti-dust covers
- **XT100.KEY** Automatic clamping tool



Keystone module Cat.5e FTP/STP

Express 5e

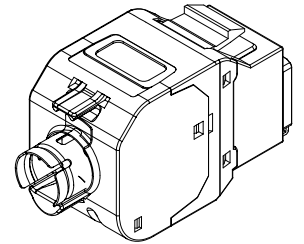
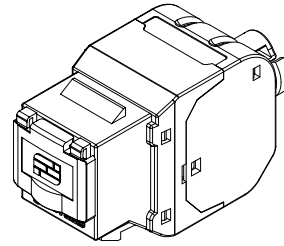

Keystone FIBRAINDATA Cat.5e FTP/STP with green anti-dust cover

XE100.450

WITH GREEN ANTI-DUST COVER



Colorful cover



<1 min
installation time

ELECTRICAL AND MECHANICAL PARAMETERS

Compliance with the norm	ISO 11801 ed.2.2. EN 50173. TIA 568-C.2. IEC 60603-7-3
Operating temperature	-10 °C to 60 °C
Storage temperature	-40 °C to 70 °C
Connector class	Cat.5/Cat.6
Shielding	yes
Housing material	UL-94-V0
Max. amperage [A]	1.5
Min. insulation resistance [MΩ]	500
Max DC resistance [Ω]	0.1
Contact material	Phosphor-bronze (CuSN)
Contacts	Min 0.75 µm gold layer, min. 1.3 µm nickel layer
IDC connector material	Phosphor-bronze (CuSN)
IDC covering	Min 1.27 µm silver layer, min. 2.5 µm nickel layer
Conductor diameter range (wire)	0.4 mm (AWG26) – 0.65 mm (AWG22)
Conductor diameter range (rope)	AWG26/7 – AWG22/7
Min. connection cycles qty	750
Min. module re-termination	20
Mounting	keystone

Features

- Tool-less
- Housing minimizes wires unbraiding
- Flame-retardant materials UL94V-0
- Anti-dust cover
- Sequence identification 568A and 568B

Standards

- "Keystone" standard ensures assembly compatibility
- Structured cabling standards ISO/IEC 11801:2011, EN 0173:2011, TIA/EIA568 - C.2
- Verification in accordance with the new standards by independent laboratory centres

Accessories

- **XB-DC-W-01** 25 pcs white anti-dust covers
- **XB-DC-Y-01** 25 pcs yellow anti-dust covers
- **XB-DC-R-01** 25 pcs red anti-dust covers
- **XB-DC-BK-01** 25 pcs black anti-dust covers
- **XT100.KEY** Automatic clamping tool



Keystone module Cat.6 UTP

Copper cabling

Quick 6

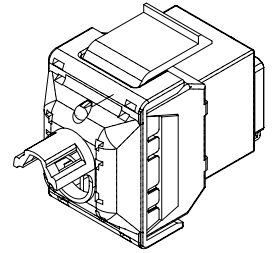
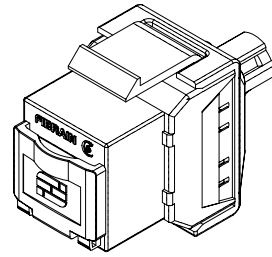

Keystone FIBRAINDATA Cat.6 UTP with blue anti-dust cover

XQ100.400

WITH BLUE ANTI-DUST COVER



Third Party Testing



Colorful cover



<1 min installation time

ELECTRICAL AND MECHANICAL PARAMETERS

Compliance with the norm	ISO 11801 ed.2.2. EN 50173. TIA 568-C.2. IEC 60603-7-3
Operating temperature	-10 °C to 60 °C
Storage temperature	-40 °C to 70 °C
Connector class	Cat.5/Cat.6
Shielding	none
Housing material	UL-94-V0
Max. amperage [A]	1.5
Min. insulation resistance [MΩ]	500
Max DC resistance [Ω]	0.1
Contact material	Phosphor-bronze (CuSN)
Contacts	Min 0.75 μm gold layer, min. 1.3 μm nickel layer
IDC connector material	Phosphor-bronze (CuSN)
IDC covering	Min 1.27 μm silver layer, min. 2.5 μm nickel layer
Conductor diameter range (wire)	0.4 mm (AWG26) – 0.65 mm (AWG22)
Conductor diameter range (rope)	AWG26/7 – AWG22/7
Min. connection cycles qty	750
Min. module re-termination	20
Mounting	keystone

Features

- Tool-less
- Housing minimizes wires unbraiding
- Flame-retardant materials UL94V-0
- Anti-dust cover
- Sequence identification 568A and 568B

Standards

- "Keystone" standard ensures assembly compatibility
- Structured cabling standards ISO/IEC 11801:2011, EN 0173:2011, TIA/EIA568 - C.2
- Verification in accordance with the new standards by independent laboratory centres

Accessories

- XB-DC-W-01 25 pcs white anti-dust covers
- XB-DC-Y-01 25 pcs yellow anti-dust covers
- XB-DC-R-01 25 pcs red anti-dust covers
- XB-DC-BK-01 25 pcs black anti-dust covers
- XT100.KEY Automatic clamping tool



Quick 6

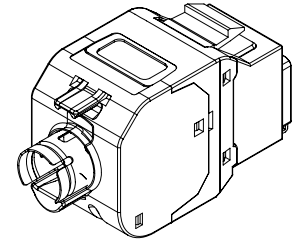
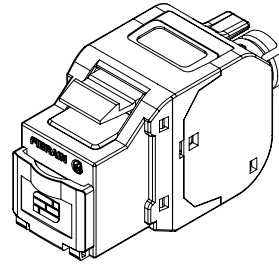

Keystone FIBRAINDATA Cat.6 FTP/STP with blue anti-dust cover
XQ100.450
WITH BLUE ANTI-DUST COVER



Third Party Testing



Colorful cover



<1 min installation time

ELECTRICAL AND MECHANICAL PARAMETERS	
Compliance with the norm	ISO 11801 ed.2.2. EN 50173. TIA 568-C.2. IEC 60603-7-3
Operating temperature	-10 °C to 60 °C
Storage temperature	-40 °C to 70 °C
Connector class	Cat.5/Cat.6
Shielding	yes
Housing material	UL-94-V0
Max. amperage [A]	1.5
Min. insulation resistance [MΩ]	500
Max DC resistance [Ω]	0.1
Contact material	Phosphor-bronze (CuSn)
Contacts	Min 0.75 µm gold layer, min. 1.3 µm nickel layer
IDC connector material	Phosphor-bronze (CuSn)
IDC covering	Min 1.27 µm silver layer, min. 2.5 µm nickel layer
Conductor diameter range (wire)	0.4 mm (AWG26) – 0.65 mm (AWG22)
Conductor diameter range (rope)	AWG26/7 – AWG22/7
Min. connection cycles qty	750
Min. module re-termination	20
Mounting	keystone

Features

- Tool-less
- Housing minimizes wires unbraiding
- Flame-retardant materials UL94V-0
- Anti-dust cover
- Sequence identification 568A and 568B

Standards

- "Keystone" standard ensures assembly compatibility
- Structured cabling standards ISO/IEC 11801:2011, EN 0173:2011, TIA/EIA568 - C.2
- Verification in accordance with the new standards by independent laboratory centres

Accessories

- **XB-DC-W-01** 25 pcs white anti-dust covers
- **XB-DC-Y-01** 25 pcs yellow anti-dust covers
- **XB-DC-R-01** 25 pcs red anti-dust covers
- **XB-DC-BK-01** 25 pcs black anti-dust covers
- **XT100.KEY** Automatic clamping tool



Keystone module Cat.6_A FTP/STP

Copper cabling

Rapid 6a

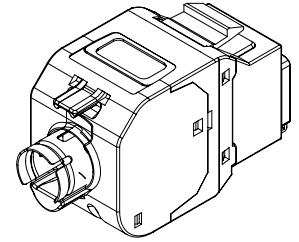
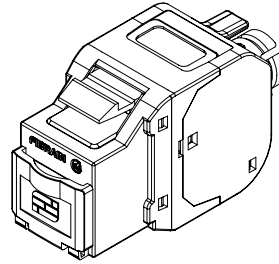

Keystone FIBRAINDATA Cat.6_A FTP/STP with aqua anti-dust cover

XR100.450

WITH AQUA ANTI-DUST COVER



Third Party Testing



Colorful cover



<1 min installation time

ELECTRICAL AND MECHANICAL PARAMETERS

Compliance with the norm	ISO 11801 ed.2.2. EN 50173. TIA 568-C.2. IEC 60603-7-3
Operating temperature	-10 °C to 60 °C
Storage temperature	-40 °C to 70 °C
Connector class	Cat.5/Cat.6/Cat.6 _A
Shielding	yes
Housing material	UL-94-V0
Max. amperage [A]	1.5
Min. insulation resistance [MΩ]	500
Max DC resistance [Ω]	0.1
Contact material	Phosphor-bronze (CuSN)
Contacts	Min 0.75 μm gold layer, min. 1.3 μm nickel layer
IDC connector material	Phosphor-bronze (CuSN)
IDC covering	Min 1.27 μm silver layer, min. 2.5 μm nickel layer
Conductor diameter range (wire)	0.4 mm (AWG26) – 0.65 mm (AWG22)
Conductor diameter range (rope)	AWG26/7 – AWG22/7
Min. connection cycles qty	750
Min. module re-termination	20
Mounting	keystone

Features

- Tool-less
- Housing minimizes wires unbraiding
- Flame-retardant materials UL94V-0
- Anti-dust cover
- Sequence identification 568A and 568B

Standards

- "Keystone" standard ensures assembly compatibility
- Structured cabling standards ISO/IEC 11801:2011, EN 0173:2011, TIA/EIA568 - C.2
- Verification in accordance with the new standards by independent laboratory centres

Accessories

- **XB-DC-W-01** 25 pcs white anti-dust covers
- **XB-DC-Y-01** 25 pcs yellow anti-dust covers
- **XB-DC-R-01** 25 pcs red anti-dust covers
- **XB-DC-BK-01** 25 pcs black anti-dust covers
- **XT100.KEY** Automatic clamping tool



Field Plug Cat.6_A FTP/STP

Rapid 6a

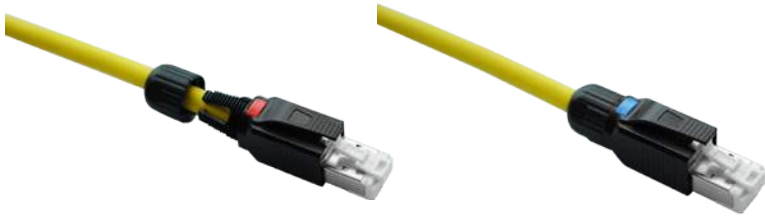

Connection modules/plugs



IP20 resistance



Two types of wire manager



10Gbps bandwidth

Features

- Industry compatible design
- 360° shielding for better EMI/EMC
- Integrated strain relief
- Field and easy install
- Compatible with EN 50173 / ISO IEC 118

Norms

- Qualified Screened Class EA/Cat.6A
- Permanent Link & Channel ANSI/TIA-568-C.2
- IEC 60603-7-51
- ISO/IEC 11801 2.2 Edition
- CENELEC EN 50173-1:201

Field Plug FIBRAINDATA Cat.6 _A FTP/STP	
XR100.350	
FOR 22-23 AND 24-26 AWG	

ELECTRICAL AND MECHANICAL PARAMETERS	
Maximum current value [A]	1.5
Insulation strength [MΩ] min	500
Contacts resistance [MΩ] max	20
DC Resistance [Ω] max	0.1
Compliance with the norm	IEC 11801 2nd Ed. Am. 1
Compliance with the norm	ANSI/TIA/EIA 568-C-2.1
Jacket	Shielded RJ45 Cat.6A
Housing	UL94V-0
Sequence identification	T568A and T568B

Field plug Cat.6_A FTP/STP Manufacturing technology

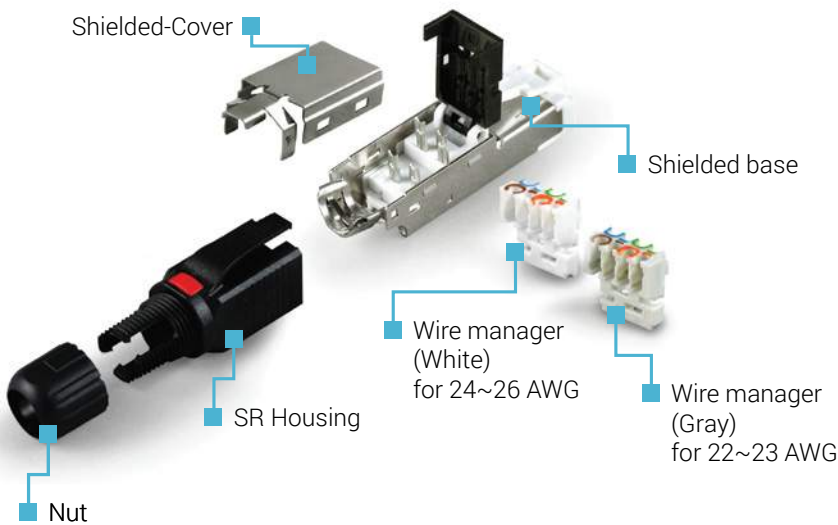

COPPER



FIBRAINDATA

PATCH PANELS

Trust first-class components, trust Fibrain quality



CABLE SHELF ARRANGEMENT

To facilitate arrangement panels are always equipped with cable shelf



PORTS PACKAGING

Panels are available in 1U and 0.5 U option ensuring termination up to 24 ports



WELL - EQUIPPED

A set of cable ties, M6 screws, installation guide together with a panel



RE-EMBEDDED PASS

Panels from cat. 6 and higher are verified with the use of Re-Embedded method confirmed with 3P Third Party Test Certificate

PATCH PANELS

UTP

UNSHIELDED PANELS



ANGULAR IDC CONNECTION

In each element we take care of dynamic parameters- angular connection reduces RL and NEXT

FTP

SHIELDED PANELS



FARADAY CAGE

In a complete panel there is a shielded cover with a shielded grounding point



9-PIN IDC CONNECTOR

Panels have 3 independent contact points with shield due to extra pin on IDC connection

FO/CU

FULLY SCALABLE AND MODULAR SOLUTION FO/CU



PANEL WITH NOBLE METALS

IDC Couplers covered with 1.27 μm silver layer
Contacts covered with 50 μm gold layer

Express 5e

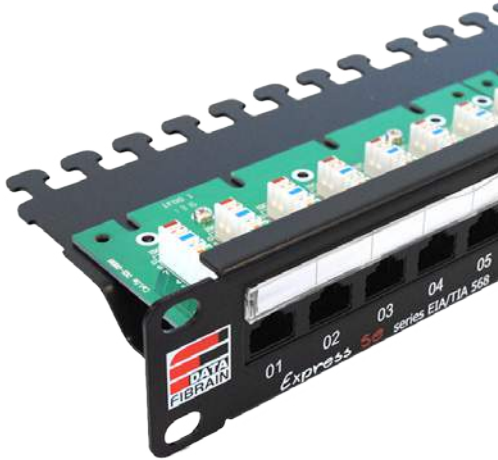

Patch panel 1U Express 5e XE100.200
UTP 24 ports

- Standards**
- 19" standard - facilitates mounting
 - Structured cabling comply with ISO/IEC 11801:2011, EN 50173:2011, TIA/EIA 568-C.2 standards
 - Verification in accordance with the new standards by independent laboratory centres

- Features**
- 1U, 19"
 - Depth: 110 mm
 - 8-pin IDC connectors
 - Material: powder-coated sheet, black
 - Facilitated cable arrangement (cable shelf)
 - Exchangeable description field
 - Clear numbering of ports and panels

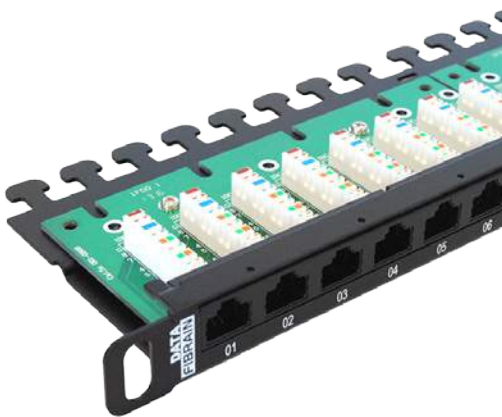

Patch panel 0.5U Express 5e XE100.205
UTP 24 ports

- Standards**
- 19" standard - facilitates mounting
 - Structured cabling comply with ISO/IEC 11801:2011, EN 50173:2011, TIA/EIA 568-C.2 standards
 - Verification in accordance with the new standards by independent laboratory centres

- Features**
- 0.5U, 19"
 - Depth: 95 mm
 - 8-pin IDC connectors
 - Material: powder-coated sheet, black
 - Facilitated cable arrangement (cable shelf)
 - Clear numbering of ports and panels

ELECTRICAL AND MECHANICAL PARAMETERS

Maximum current value [A]	1.5
Insulation strength [MOhm] min	500
Contacts resistance [MOhm] max	20
DC Resistance [Ohm] max	0.1
Compliance with the norm	IEC 60603-7 Class D
Compliance with the norm	TIA568-B Cat.5e
Frame	1.5 mm steel sheet
Jacket	Non-shielded RJ45 Cat.5e
Housing	UL94V-0 black thermoplastic
Contact material	phosphor-bronze
Contacts	0.46mm diameter covered with 0.75 µm gold and 1.3 µm nickel layer
Jack durability	>750 connection cycles in accordance with EN60603-7
IDC connector	IDC LSA
Wire diameter	0.4-0.65 mm (AWG26-22)
IDC durability	>200 connection cycles
Coupler material	phosphor-bronze
Coupler coating	1.27 µm silver and 2.5 µm nickel layer
Sequence identification	T568A and T568B

Express 5e



Patch panel 1U Express 5e XE100.250

FTP/STP 24 ports



Standards

- 19" standard - facilitates mounting
- Structured cabling comply with ISO/IEC 11801:2011, EN 50173:2011, TIA/EIA 568-C.2 standards
- Verification in accordance with the new standards by independent laboratory centres



Features

- 1U, 19"
- Depth: 110 mm
- 9-pin IDC connectors
- Shielded cover connected to grounding point
- Material: powder-coated sheet, black
- Facilitated cable arrangement (cable shelf)
- Exchangeable description field
- Clear numbering of ports and panels



Patch panel 0.5U Express 5e XE100.255

FTP/STP 24 ports



Standards

- 19" standard - facilitates mounting
- Structured cabling comply with ISO/IEC 11801:2011, EN 50173:2011, TIA/EIA 568-C.2 standards
- Verification in accordance with the new standards by independent laboratory centres



Features

- 0.5U, 19"
- Depth: 95 mm
- 9-pin IDC connectors
- Shielded cover connected to grounding point
- Facilitated cable arrangement (cable shelf)
- Clear numbering of ports and panels

ELECTRICAL AND MECHANICAL PARAMETERS

Maximum current value [A]	1.5
Insulation strength [MOhm] min	500
Contacts resistance [MOhm] max	20
DC Resistance [Ohm] max	0.1
Compliance with the norm	IEC 60603-7 Class D
Compliance with the norm	TIA568-B Cat.5e
Frame	1.5 mm steel sheet
Shield	Shielded cover made of 1.0 mm galvanized steel
Jacket	Shielded RJ45 Cat.5e
Housing	UL94V-0 black thermoplastic
Contact material	phosphor-bronze
Contacts	0.48mm diameter covered with 0.75 µm gold and 1.3 µm nickel layer
Jack durability	>750 connection cycles in accordance with EN60603-7
IDC connector	IDC LSA
Wire diameter	0.4-0.65 mm (AWG26-22)
IDC durability	>200 connection cycles
Coupler material	phosphor-bronze
Coupler coating	1.27 µm silver and 2.5 µm nickel layer
Sequence identification	T568A and T568B

Quick 6

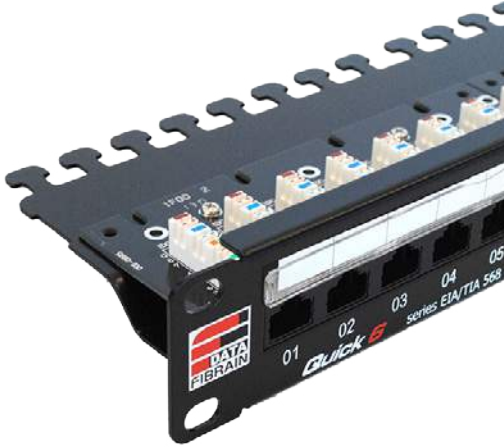

Patch panel 1U Quick 6 XQ100.200
UTP 24 ports

- Standards**
- 19" standard - facilitates mounting
 - Structured cabling comply with ISO/IEC 11801:2011, EN 50173:2011, TIA/EIA 568-C.2 certified by independent laboratory centres
 - Verification in accordance with the new standards by independent laboratory centres

- Features**
- 1U, 19"
 - Depth: 110 mm
 - 8-pin IDC connectors
 - Material: powder-coated sheet, black RAL9005
 - Facilitated cable arrangement (cable shelf)
 - Exchangeable description field
 - Clear numbering of ports and panels

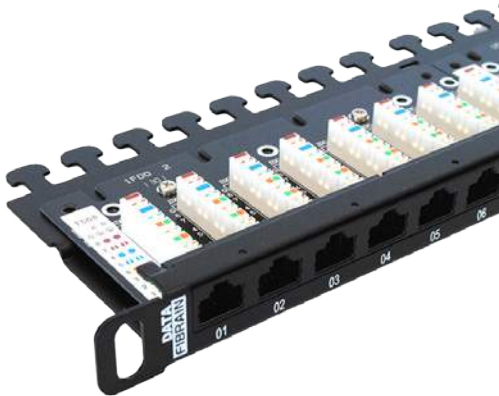

Patch panel 0.5U Quick 6 XQ100.205
UTP 24 ports

- Standards**
- 19" standard - facilitates mounting
 - Structured cabling comply with ISO/IEC 11801:2011, EN 50173:2011, TIA/EIA 568-C.2 certified by independent laboratory centres
 - Verification in accordance with the new standards by independent laboratory centres

- Features**
- 0.5U, 19"
 - Depth: 95 mm
 - 8-pin IDC connectors
 - Material: powder-coated sheet, black RAL9005
 - Facilitated cable arrangement (cable shelf)
 - Clear numbering of ports and panels

ELECTRICAL AND MECHANICAL PARAMETERS

Insulation strength [MΩ] min	500
Contacts resistance [MΩ] max	20
DC Resistance [Ω] max	0.1
Compliance with the norm	IEC 60603-7 Class E
Compliance with the norm	TIA568-B Cat.6
Frame	1.5 mm steel sheet
Jacket	Non-shielded RJ45 Cat.6
Housing	UL94V-0 black thermoplastic
Contact material	phosphor-bronze
Contacts	0.46mm diameter covered with 0.75 μm gold and 1.3 μm nickel layer
Jack durability	>750 connection cycles in accordance with EN60603-7
IDC connector	IDC LSA
Wire diameter	0.4-0.65 mm (AWG26-22)
IDC durability	>200 connection cycles
Coupler material	phosphor-bronze
Coupler coating	1.27 μm silver and 2.5 μm nickel layer
Sequence identification	T568A and T568B

Quick 6



Patch panel 1U Quick 6 XQ100.250
FTP/STP 24 ports



Standards

- 19" standard - facilitates mounting
- Structured cabling comply with ISO/IEC 11801:2011, EN 50173:2011, TIA/EIA 568-C.2 certified by independent laboratory centres
- Verification in accordance with the new standards by independent laboratory centres



Features

- 1U, 19"
- Depth: 110 mm
- 9-pin IDC connectors
- Shielded cover connected to grounding point
- Material: powder-coated sheet, black
- Facilitated cable arrangement (cable shelf)
- Exchangeable description field
- Clear numbering of ports and panels



Patch panel 0.5U Quick 6 XQ100.255
FTP/STP 24 ports



Standards

- 19" standard - facilitates mounting
- Structured cabling comply with ISO/IEC 11801:2011, EN 50173:2011, TIA/EIA 568-C.2 certified by independent laboratory centres
- Verification in accordance with the new standards by independent laboratory centres



Features

- 0.5U, 19"
- Depth: 95 mm
- 9-pin IDC connectors
- Shielded cover connected to grounding point
- Facilitated cable arrangement (cable shelf)
- Clear numbering of ports and panels

ELECTRICAL AND MECHANICAL PARAMETERS

Maximum current value [A]	1.5
Insulation strength [MΩ] min	500
Contacts resistance [MΩ] max	20
DC Resistance [Ω] max	0.1
Compliance with the norm	IEC 60603-7 Class E
Compliance with the norm	TIA568-B Cat.6
Frame	1.5 mm steel sheet
Shield	Shielded cover made of 1.0 mm galvanized steel
Jacket	Shielded RJ45 Cat.6
Housing	UL94V-0 black thermoplastic
Contact material	phosphor-bronze
Contacts	0.48mm diameter covered with 0.75 μm gold and 1.3 μm nickel layer
Jack durability	>750 connection cycles in accordance with EN60603-7
IDC connector	IDC LSA
Wire diameter	0.4-0.65 mm (AWG26-22)
IDC durability	>200 connection cycles
Coupler material	phosphor-bronze
Coupler coating	1.27 μm silver and 2.5 μm nickel layer
Sequence identification	T568A and T568B



Patch panel 1U Rapid 6_A XR100.250

FTP/STP 24 ports



Standards

- 19" standard - facilitates mounting
- Structured cabling comply with ISO/IEC 11801:2011, EN 50173:2011, TIA/EIA 568-C.2 certified by independent laboratory centres
- Verification in accordance with the new standards by independent laboratory centres



Features

- 1U, 19"
- Depth: 110 mm
- 9-pin IDC connectors
- Material: powder-coated sheet, black
- Facilitated cable arrangement (cable shelf)
- Exchangeable description field
- Clear numbering of ports and panels



Patch panel 0.5U Rapid 6_A XR100.255

FTP/STP 24 ports



Standards

- 19" standard - facilitates mounting
- Structured cabling comply with ISO/IEC 11801:2011, EN 50173:2011, TIA/EIA 568-C.2 certified by independent laboratory centres
- Verification in accordance with the new standards by independent laboratory centres



Features

- 0.5U, 19"
- Depth: 95 mm
- 9-pin IDC connectors
- Shielded cover connected to grounding point
- Facilitated cable arrangement (cable shelf)
- Clear numbering of ports and panels

ELECTRICAL AND MECHANICAL PARAMETERS

Maximum current value [A]	1.5
Insulation strength [MΩ] min	500
Contacts resistance [MΩ] max	20
DC Resistance [Ω] max	0.1
Compliance with the norm	IEC 60603-7 Class EA
Compliance with the norm	TIA568-B Cat.6A
Frame	1.5 mm steel sheet
Shield	Shielded cover made of 1.0 mm galvanized steel
Jacket	Shielded RJ45 Cat.6A
Housing	UL94V-0 black thermoplastic
Contact material	phosphor-bronze
Contacts	0.48mm diameter covered with 0.75 μm gold and 1.3 μm nickel layer
Jack durability	>750 connection cycles in accordance with EN60603-7
IDC connector	IDC LSA
Wire diameter	0.4-0.65 mm (AWG26-22)
IDC durability	>200 connection cycles
Coupler material	phosphor-bronze
Coupler coating	1.27 μm silver and 2.5 μm nickel layer
Sequence identification	T568A and T568B

Patch Panel 1U24xRJ45u/s, empty



TECHNICAL SPECIFICATIONS

Case material	Galvanised steel
Colour	Grey RAL 7035 (XB101.224)
	Black RAL 9005 (XB101.224.1)
Temperature range	-40°C to +70°C
Height	1U
Width	19" (
Scope of supply	Frame, empty
Weight [kg]	2.1

Ordering information

Code	Description
XB101.224	Patch Panel 1U24xRJ45u/s, empty, 1U, grey RAL 7035
XB101.224.1	Patch Panel 1U24xRJ45u/s, empty, 1U, black RAL 9005

Patch panels

Description

- SD patch panel is the most flexible platform for serve either copper or FO connection. It can be equipped up to 24 RJ45 ports of Cat5-Cat6A or up to 96 fibers terminated with wide range of connectors LC/E2000/SC. Patch panel has 8 empty slots which can be equipped with copper holder (6x RJ45) or fully equipped FO cassettes spliced or for pre-terminated connectors including MPO/MTP connectors.

Applications

- Nodal points of fiber optic networks
- Distribution points of fiber optic networks
- Server rooms

Features

- 1U, 19"
- For all keystone modules (shielded/unshielded)
- Facilitated cable arrangement (cable shelf)
- Up to 24xRJ45/u/s
- Staggered port arrangement to avoid Alien-Crosstalk
- Exchangeable description field
- Coloured anti-dust covers
- Solid metal body for galvanised connection with modules shield (in case of using shielded modules)

SD modular patch panel, empty



TECHNICAL SPECIFICATIONS

Case material	Powder paint coated steel
Colour	Front: chrome-plated steel
	Closure: Black RAL 9005
Temperature range	-40°C to +70°C
Max. copper holders	4
Max. FO cassettes	8
Scope of supply	Frame, empty
Weight [kg]	2.1

Ordering information

Code	Description
XB100.2SD	SD modular patch panel, empty

Description

- SD patch panel is the most flexible platform for serve either copper or FO connection. It can be equipped up to 24 RJ45 ports of Cat5-Cat6A or up to 96 fibers terminated with wide range of connectors LC/E2000/SC. Patch panel has 8 empty slots which can be equipped with copper holder (6x RJ45) or fully equipped FO cassettes spliced or for pre-terminated connectors including MPO/MTP connectors.

Applications

- Nodal points of fiber optic networks
- Distribution points of fiber optic networks
- Server rooms

Features

- Modular configuration system:
 - Possibility for FO/Cu assembling,
 - Different cable entry adapters for different cables fixed in the rear
 - Patch cables manager from front (optional)
- Capacity: up to 8 FO/Cu modules
- Max ports density:
 - 24 port/1U for copper
 - 96 FO fibers (for LCd)
- Full range of connectors:
 - RJ45 – Cat.5u/s, Cat.6u/s, Cat.6Au/s
 - LCd, LCq, E2000, SC, SCd. – MM/SM

SD 6x RJ45 module, unequipped

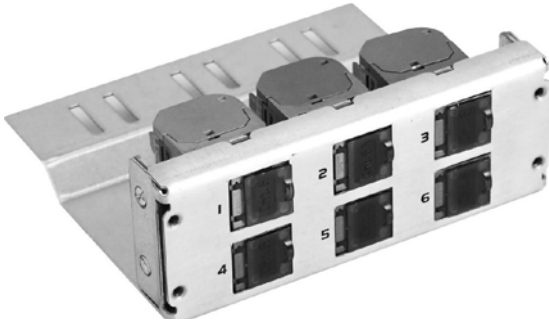

TECHNICAL SPECIFICATIONS

Case material	Stainless steel
Colour	Front: chrome-plated steel
	Closure: Black RAL 9005
Temperature range	-40°C to +70°C
Protection level	IP20 (according to PN-EN 60529)
Weight [kg]	0.12

Ordering information

Code	Description
XB100.2SD.MCU	SD module, unequipped

Description

→ SD patch panel is the most flexible platform for serve either copper or FO connection. It can be equipped up to 24 RJ45 ports of Cat5-Cat6A or up to 96 fibers terminated with wide range of connectors LC/E2000/SC. Patch panel has 8 empty slots which can be equipped with copper holder (6x RJ45) or fully equipped FO cassettes spliced or for pre-terminated connectors including MPO/MTP connectors.

Applications

- Nodal points of fiber optic networks
- Distribution points of fiber optic networks
- Server rooms

Features

- Modular configuration system:
 - One-port modularity
 - Full range of connectors: RJ45 – Cat.5u/s, Cat.6u/s, Cat.6Au/s
 - Mounting: keystone
 - Port numbering
- Specifically designed place to cable mounting
- Capacity: up to 6x RJ45
- Capacity in SD panel: up to 4 modules
- Flip cover with a labelling sticker

SD patch panel accessories

Blind cover 0.5U

Blind cover for front of SD patch panel



DIMENSIONS	
Length [mm]	220
Width [mm]	129
Height [mm]	35

ORDERING INFORMATION	
XB100.2SD.PPZ	Blind cover 0.5U

Blind cover 1U

Blind cover for rear of SD patch panel



DIMENSIONS	
Length [mm]	220
Width [mm]	129
Height [mm]	35

ORDERING INFORMATION	
XB100.2SD.PTZ	Blind cover 1U

Cable gland holder for SD patch panel

Cable gland holder for SD Patch panel. Holder can be installed to rear side of panel. It enables to fix 2 cable glands of Φ xx



DIMENSIONS	
Length [mm]	220
Width [mm]	129
Height [mm]	35

ORDERING INFORMATION	
XB100.2SD.PTD	Cable gland holder

Cable holder for SD panel

Cable holder enables fixation of cables/tubes which enter SD patch panel. Occupies one rear slot.



DIMENSIONS	
Length [mm]	220
Width [mm]	129
Height [mm]	35

ORDERING INFORMATION	
XB100.2SD.PTT	Blind cover 1U

Cable holder for SD panel, double

Cable holder intended for fixation of multitube cables. Enables easy installation and distribution tubes within the space of SD patch panel



DIMENSIONS	
Length [mm]	220
Width [mm]	129
Height [mm]	35

ORDERING INFORMATION	
XB100.2SD.PTT	Blind cover 1U

19" cable organizer

To arrange cables in SD patch panel. Equipped with a flip cover with a sticker that facilitates markings



DIMENSIONS	
Depth [mm]	69.5
Width [mm]	482
Height [mm]	44 (1U)

ORDERING INFORMATION	
XB100.2SD.ORG	19" cable organizer

Voice panels



ELECTRICAL AND MECHANICAL PARAMETERS

Frame	1.5 mm steel sheet
Jacket	Non-shielded RJ45 Cat.3
Housing	UL94V-0 black thermoplastic
Contact material	phosphor-bronze
Contacts	0.35 mm diameter covered with 0.75 µm gold and 1.3 µm nickel layer
Jack durability	>750 connection cycles in accordance with EN60603-7
IDC connector	IDC LSA
Wire diameter	0.4-0.65 mm (AWG26-22)
IDC durability	>200 connection cycles
Coupler material	phosphor-bronze
Coupler coating	Brass Sn 60% Pb 40%
Sequence identification	T568A and T568B

Ordering information

Code	Description
XV100.200	Patch Panel FIBRAINDATA voice series 25 ports
XV100.210	Patch Panel FIBRAINDATA voice series 50 ports

Patch panels

Description

→ FIBRAINDATA Structural Cabling Voice System, fully satisfies the requirements of cat 3 (class C) in accordance with standards ISO/IEC 11801, EN 50173 and ANSI/TIA/EIA 568-C.2. This series is dedicated for structured cabling installations, for digital and analog telephone signals transmissions. VOICE products offers good transmission parameters need for voice applications, easy connectorization of cables and convenience of use. Also all components of the transmission line complete ROHS 2002/95/WE Directive. Additional asset is certainty of connection using standard RJ45-RJ45 cables. Patch panels Voice series fully meet demands Cat.3 and provide digital and analog telephone signals transmissions. Contain 4 pins (2 pairs) IDC-LSA and offers fast and easy installation. Main body designed in L-type shelf. Quick and simple access to IDC for better restoration and eventual link reconnection. Panel front was equipped in description fields with pre-printed identification.

Applications

- PBX
- Point-to-Point
- Token Ring4 Mbit/s
- ATM LAN 51.84 Mbit/s
- ATM LAN 155.52 Mbit/s
- Analog and digital transmission of phone signals

Features

- 1U high, 19" for 25 and 50 ports
- ISDN 4-poles (3/6, 4/5)
- L-type shelf construction
- Quick and simple access to IDC
- Description fields with pre-printed identification

COPPER

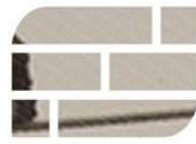

FIBRAINDATA

PATCH CORDS

Our solutions ensure stable and secure transmission

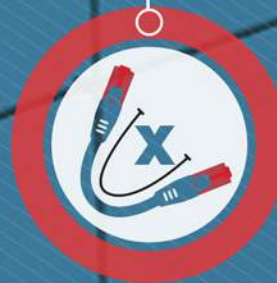

PATCH CORD CABLE LENGTH

Various cable lengths and solutions are available



PAIR SEPARATION

Connectors equipped with X pair separators ensure pair twisting to RJ45 clamp



BENDING RADIUS PROTECTION

Patch cord cables equipped with a bending radius-limiting system



CABLE COLOUR

Patch cord cables are available in 9 colours

PATCH CORDS

UTP

**UNSHIELDED
PATCH CORD**



5 BOOT COLOURS

Patch cord cable identification by cable colour or boot colour

**450
MHz**



450MHz U/UTP CAT.6

Patch cord cables manufactured with the use of U/UTP 450MHz LSZH cat. 6

FTP

**SHIELDED
PATCH CORD**

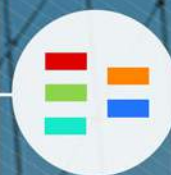

5 CABLE IDENTIFICATION STEPS

Additional colour coding elements: icons, cable, connector, boot and strain relief

**900
MHz**



900MHz S/FTP CAT. 7

Patch cord cables manufactured with the use of S/FTP 900MHz FR-LSZH cat. 7



MADE IN POLAND

Patch cord cable manufacturing in Advanced Technology & Manufacturing Center in Zaczerwie

Patch cords Cat.5e

Copper cabling



Patch cord Cat.5e unshielded

Manufacturing technology

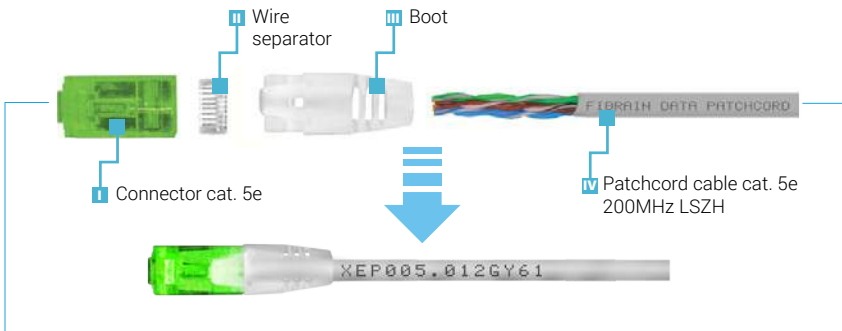

UTP Distinctive features



Bending radius reduction system



Cable frequency – 200MHz

Applications

- Connection to a user's point
- Connection to a consolidation point
- Supplied in Data Center and consolidation points
- Complete transmission channel



Ordering syntax

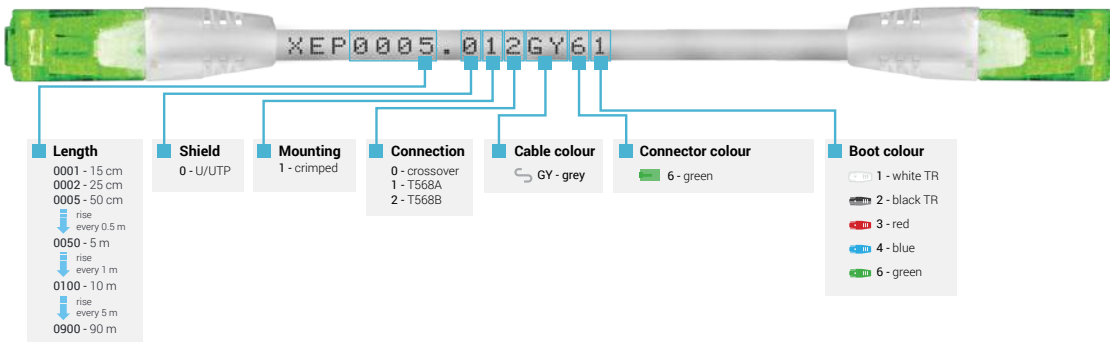

Patch cord Cat.5e shielded

Manufacturing technology

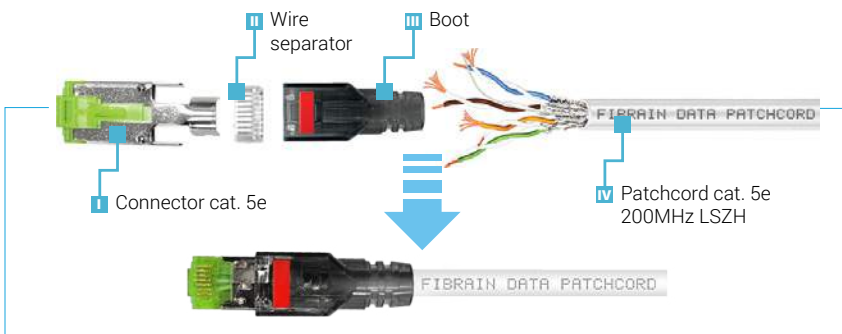

FTP/STP Distinctive features



Bending radius reduction system



Cable frequency – 200MHz

Applications

- Connection to a user's point
- Connection to a consolidation point
- Supplied in Data Center and consolidation points
- Complete transmission channel



Ordering syntax

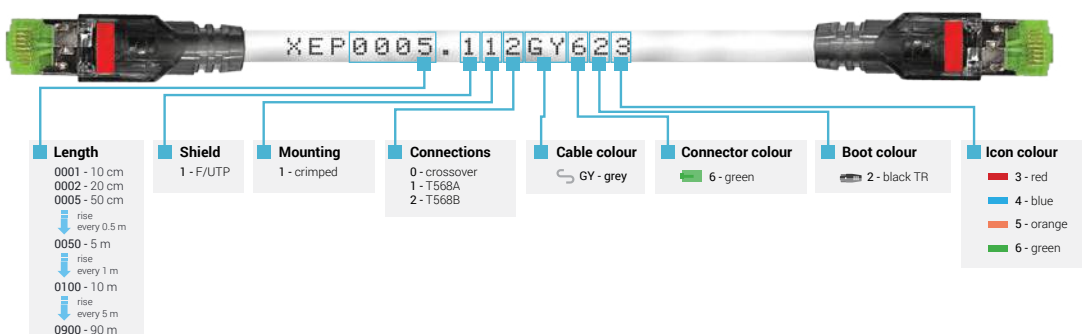



Standard manufacturing

Unshielded

Cable colour	Length	
 grey	0.5 m	XEP0050.012GY61
	1 m	XEP0100.012GY61
	2 m	XEP0200.012GY61
	3 m	XEP0300.012GY61
	5 m	XEP0500.012GY61
	10 m	XEP1000.012GY61

Shielded

Cable colour	Length	
 grey	0.5 m	XEP0050.112GY623
	1 m	XEP0100.112GY623
	2 m	XEP0200.112GY623
	3 m	XEP0300.112GY623
	5 m	XEP0500.112GY623
	10 m	XEP1000.112GY623

Features

- Possibility of performing specifically designed solution to manage the infrastructure on a physical structure
- Made by FIBRAIN with the use of patented components which comply with all necessary mechanical Standards in ANSI/ICESA S - 102-732-2009
- Twisted cable pairs ensure full compatibility with dynamic parameters for the dedicated line and transmission channel in accordance with ISO/IEC 11801:2011, EN501732011
- Durable elements ensure number of cycles in accordance with IEC 60603-7-x, TIA/EIA 568-0.2
- Clear marking elements of structured cabling system in order to use solid system,
- Wire separator

Patch cords Cat.6

Copper cabling



Patch cord Cat.6 unshielded Manufacturing technology

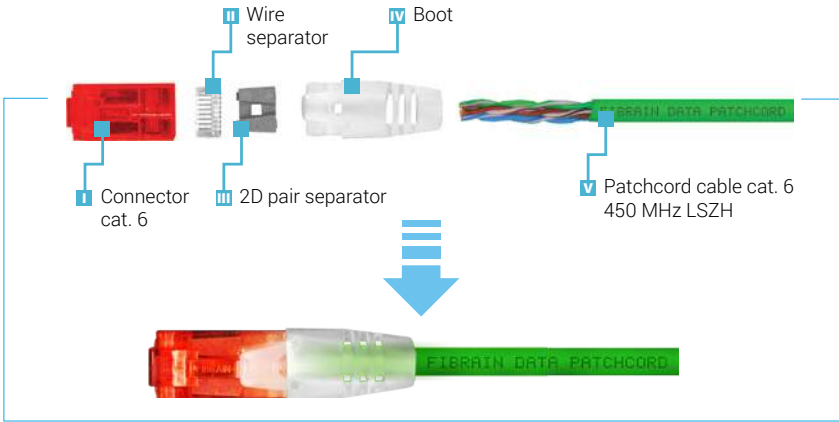

Bending radius reduction system



Cable frequency > Cat.6+



10Gbps bandwidth



2D Cross technology

Applications

- Connection to a user's point
- Connection to a consolidation's point
- Supplied in Data Center and consolidation points
- Complete transmission channel



Ordering syntax



Length	Shield	Mounting	Connections	Cable colour	Connector colour	Boot colour
0010 - 10 cm 0020 - 20 cm 0050 - 50 cm ↓ rise every 0.5 m 0500 - 5 m ↓ rise every 1 m 1000 - 10 m ↓ rise every 5 m 9000 - 90 m	0 - U/UTP	1 - crimped	0 - crossover 1 - T568A 2 - T568B	Y - yellow GR - green GY - grey BL - blue BK - black R - red W - white	3 - red	1 - white TR 2 - black TR 3 - red 4 - blue 6 - green



Patch cord Cat.6 shielded Manufacturing technology

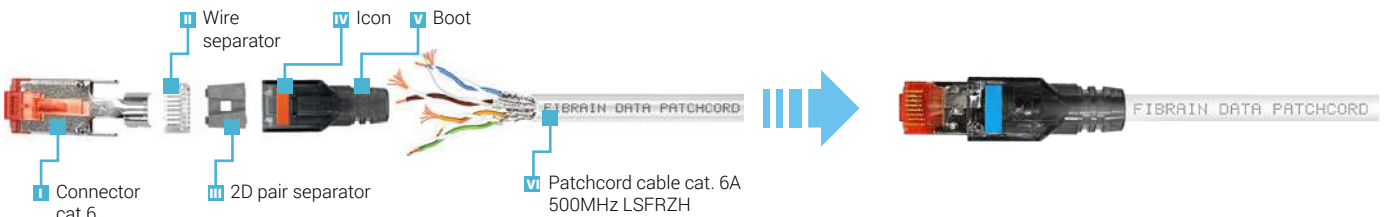

Ordering syntax



Length	Shield	Mounting	Connections	Cable colour	Connector colour	Boot colour	Icon colour
0010 - 10 cm 0020 - 20 cm 0050 - 50 cm ↓ rise every 0.5 m 0500 - 5 m ↓ rise every 1 m 1000 - 10 m ↓ rise every 5 m 9000 - 90 m	2 - S/FTP	1 - crimped	0 - crossover 1 - T568A 2 - T568B	GY - grey W - white	3 - red	2 - black TR	3 - red 4 - blue 5 - orange 6 - green



Standard manufacturing

Unshielded

Cable colour	Length	
 green	0.5 m	XQP0050.012GR31
	1 m	XQP0100.012GR31
	2 m	XQP0200.012GR31
	3 m	XQP0300.012GR31
	5 m	XQP0500.012GR31
	10 m	XQP1000.012GR31

Shielded

Cable colour	Length	
 white	0.5 m	XQP0050.212W324
	1 m	XQP0100.212W324
	2 m	XQP0200.212W324
	3 m	XQP0300.212W324
	5 m	XQP0500.212W324
	10 m	XQP1000.212W324

Features

- Possibility of performing specifically designed solution to manage the infrastructure on a physical structure
- Made by FIBRAIN with the use of patented components which comply with all necessary mechanical Standards in ANSI/ICESA S - 102-732-2009
- Twisted cable pairs ensure full compatibility with dynamic parameters for the dedicated line and transmission channel in accordance with ISO/IEC 11801:2011, EN501732011
- Durable elements ensure a number of cycles in accordance with IEC 60603-7-x, TIA/EIA 568-0.2
- Clear marking elements of structured cabling system in order to use a solid system,
- 2D pair separator
- Wire separator

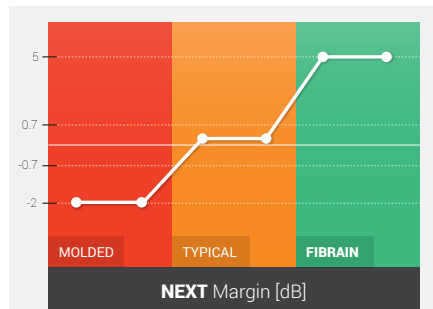

Advanced system of connector's termination with pair separation system from a place of outer jacket- improved dynamic parameters

Patch cords Cat.6_A shielded

FIBRAINDATA Patch cord Cat.6A shielded
Patch cord cable 900 MHz Cat.7



Patch cord Cat.6A shielded

Manufacturing technology

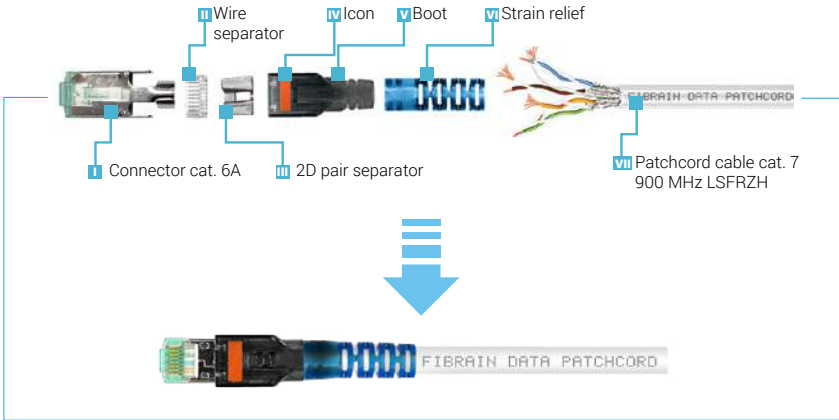

! FTP/STP Distinctive features

- 5** 5 cable identification steps
- Bending radius reduction system**
- 10 Gbps** 10Gbps bandwidth
- 2D Cross technology**

❖ Applications

- Connection to a user's point
- Connection to a consolidation point
- Supplied in Data Center and consolidation points
- Complete transmission channel



Ordering syntax

Length
0010 - 10 cm
0020 - 20 cm
0050 - 50 cm
rise every 0.5 m
0500 - 5 m
rise every 1 m
1000 - 10 m
rise every 5 m
9000 - 90 m

Shield
4 - S/FTP

Mounting
1 - crimped

Connections
0 - crossover
1 - T568A
2 - T568B

Cable colour
Y - yellow
GR - green
GY - grey
BL - blue
BK - black
R - red
W - white
AQ - aqua
V - violet

Connector colour
7 - aqua

Boot colour
2 - black TR

Icon colour
3 - red
4 - blue
5 - orange
6 - green

Strain relief colour
1 - white TR
2 - black TR
3 - red TR
4 - blue TR
6 - green TR



Standard manufacturing

Shielded

Cable colour	Length	
 green	0.5 m	XRP0050.412GR7262
	1 m	XRP0100.412GR7262
	2 m	XRP0200.412GR7262
	3 m	XRP0300.412GR7262
	5 m	XRP0500.412GR7262
	10 m	XRP1000.412GR7262



COPPER



FIBRAINDATA

ELECTRO & INSTALLATION

solutions meeting ever-increasing market requirements

45
x
45

FRENCH STYLE
STANDARD

50
x
50

BRITISH STYLE
STANDARD



FLUSH & WALL MOUNT BOXES



3 TYPES OF DEPTH



1-6 MODULES
IN A SINGLE FRAME



1-4 MODULES
IN A SINGLE FRAME



ANGLED AND FLAT
DESIGN



COPPER AND FO
FACEPLATES



MODULAR DESIGN



MODULAR DESIGN

TERMINATION OUTLETS ACCESSORIES

and standards



Flush mount boxes



2-module
GIP-2



4-module
GIP-4



6-module
GIP-6

Wall mount boxes



2-module
OBU-2



4-module
OBU-4

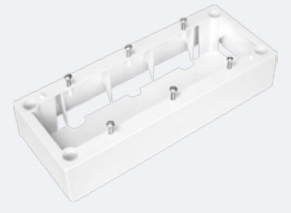

6-module
OBU-6

Mounting supports



SUP-2 45x45 mm 2-module mounting support

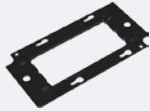

SUP-4 90x45 mm 4-module mounting support



SUP-6 135x45 mm 6-module mounting support

Mounting frame



RAM-2 frame designed for 45x45mm 2-support module





RAM-4 frame designed for 90x45mm 4-support module



RAM-6 frame designed for 135x45mm 6-support module

Flat faceplates

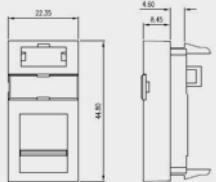
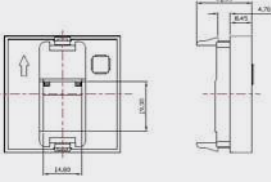
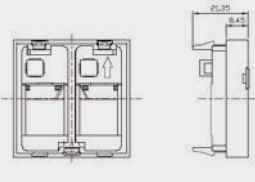
XB-45KA00S-01	XB-45KA00D-01	XB-45KA00D-02
		
		



Angle construction



45 mm dimension





Coloured identifying icons

Features

- 45x45 mm mounting
- Flat construction
- Description field and identification icons
- Anti-dust protection
- Termination 1 or 2 modules in keystone standard
- Termination any FIBRAINDATA keystone module
- Packing - easy-open bags with clear marking
- Each adapter has set of identification icons in 2 colours and description field

Flat faceplates

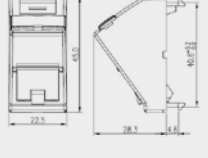
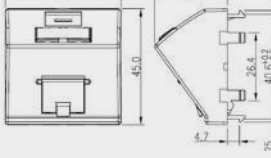
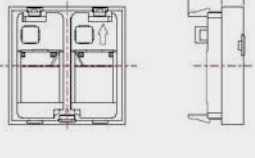
XB-45KA45S-01	XB-45KA45D-01	XB-45KA45D-02
		
		

Packing

Flat adapters

- **XB-45KA00S-01** multipack 5x adapter, individual purchase available
- **XB-45KA00D-01** 1x adapter
- **XB-45KA00D-02** 1x adapter

Angled adapters

- **XB-45KA45S-01** 1x adapter
- **XB-45KA45D-01** 1x adapter
- **XB-45KA45D-02** 1x adapter

French style system 45x45

Termination outlets

Blind cover



XB-45000S-01 blind adapter - 22.5 x 45 mm









XB-45000D-02 blind adapter - 45 x 45 mm

Features

- Designed to cover unused areas when constructing logic points
- To be mounted with frames equipped with supports
- Mounted with a clip

Electrical socket

Type	Single	Double	Triple
2P+Z electrical red socket with blocking mechanism	 XB-45PU00S-01-K	 XB-45PU00D-02-K	 XB-45PU00T-03-K
2P+Z white electrical socket	 XB-45PU00S-01	 XB-45PU00D-02	 XB-45PU00T-03
XB-45PUKEY Unlock key			

Features

- Facilitate building integrated electro-logic point
- 240 V 50 Hz / 16 A with a grounding screw
- Mounted with a clip

Complete Data and Electrical Termination outlet

Wall mount boxes



XB-50BBA-02
2-module 86 x 86 x 27 mm

XB-50BBB-02
2-module 86 x 86 x 32 mm

XB-50BBC-02
2-module 86 x 86 x 37 mm



XB-50BBA-04
4-module 86 x 146 x 27 mm

XB-50BBB-04
4-module 86 x 146 x 32 mm

XB-50BBC-04
4-module 86 x 146 x 37 mm

Mounting frames

Angular option



XB-50FPB-0002
Frame with support 2-module 50 x 50 mm



XB-50FPB-0004
4-module 100 x 50 mm

Flat option



XB-50FPF-0002
Frame with support 2-module 50 x 50 mm

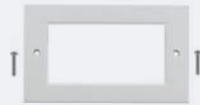

XB-50FPF-0004
4-module 100 x 50 mm

Faceplates 25x50



XB-50KA45I-01
25 x 50 mm angular adapter
designed for keystone module



XB-50SC45I-01
25 x 50 mm adapter designed for
SC- SX connection



XB-50BL000-01
25 x 50 mm blind adapter



XB-50ST45I-01
25 x 50 mm angular adapter
designed for ST SX connection



XB-50KA00L-01
25 x 50 mm flat adapter designed for keystone module

Faceplates 86x86



XB-50FPF-0102
frame with support for 1 keystone module



XB-50FPF-0202
for 2 keystone modules

Complete Data Termination outlet

American Faceplate



XB-USFPF-A01
for 1 keystone module



XB-USFPF-A02
for 2 keystone module



XB-USFPF-A04
for 4 keystone module



XB-USFPF-A06
for 6 keystone module

Wall mount boxes



XB-USBB
Wall mount box for US style faceplates for 1/2/4/6 keystone connection modules

Surface mount boxes

Wall mount module



XB-00BXIL-01
Wall-mount 1x keystone



XB-00BXIL-02
Wall-mount 2x keystone

Special designed adapters

Adapter designed for Legrand Valena frame

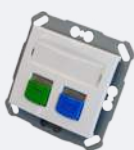

XB-LVKA00S-02
Adapter designed for Legrand Valena frame 2x keystone

Din-Rail adapter



XB-DNKA45-A1
Din – Rail adapter designed for 1 keystone module with grounding

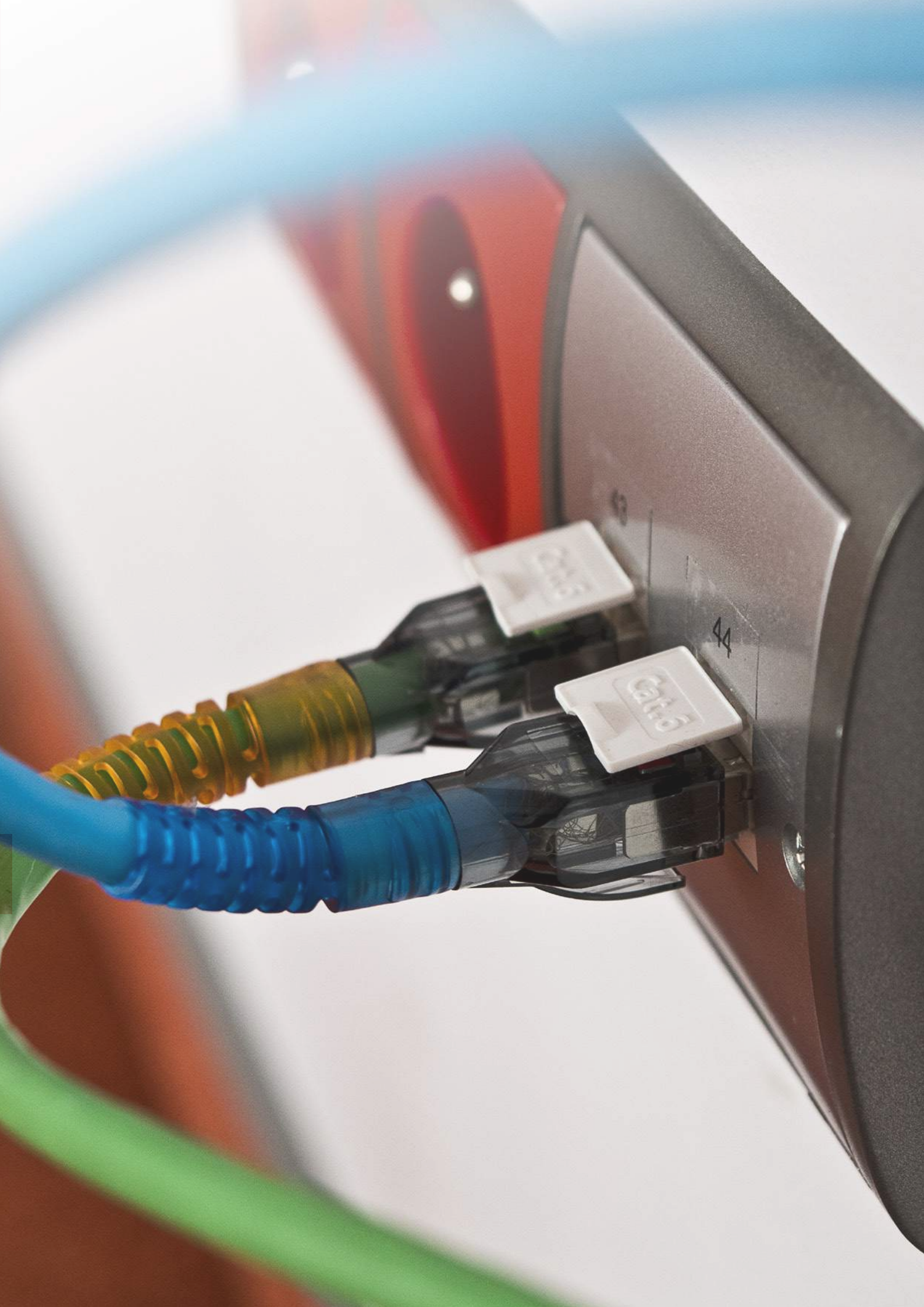



FIBRAINDATA

CABINETS

Suitable protection of teleinformatics infrastructure

SRS

SRS STANDING CABINETS

45U

21U

MOUNTING HEIGHT

21-45U

600
800
1000
mm

DEPTH

600/800/1000 mm

RAL
9005

BLACK CABINETS

RAL 9005



GLASS FRONT DOOR

1000
kg

LOAD CAPACITY

max. 1000 kg

SSRS

SSRS STANDING CABINETS

45U

STANDARD HEIGHT

45U

1000
1200
mm

DEPTH

1000/1200 mm



PERFORATED CONSTRUCTION

1360
kg

LOAD CAPACITY

1360 kg

CABINETS

SWJ

WALL MOUNT
SINGLE SECTION
SWJ CABINETS

18U
6U

MOUNTING HEIGHT
6-18U

400
600
mm

DEPTH
400/600 mm



ONE SOLID CONSTRUCTION

100
kg

LOAD CAPACITY
max. 100 kg

SWD

WALL MOUNT
TWO SECTION
SWD CABINETS

18U
6U

MOUNTING HEIGHT
6-18U

500
mm

DEPTH
500 mm



TWO PART SOLID
CONSTRUCTION

30
kg

LOAD CAPACITY
max. 30 kg



VERTICAL CABLE
ORGANIZER



HORIZONTAL CABLE
ORGANIZER



CABLE
ORGANIZERS

SRS Floor Standing Network Cabinets

21U	SRS-21-6/6-S04-B			
	Width	Depth	Height	Load cap. [kg]
	600	600	1095	300
24U	SRS-24-6/6-S04-B			
	Width	Depth	Height	Load cap. [kg]
	600	600	1210	600
24U	SRS-24-6/8-S04-B			
	Width	Depth	Height	Load cap. [kg]
	600	800	1210	600
27U	SRS-27-6/6-S04-B			
	Width	Depth	Height	Load cap. [kg]
	600	600	1315	600
27U	SRS-27-6/8-S04-B			
	Width	Depth	Height	Load cap. [kg]
	600	800	1315	600
32U	SRS-32-6/6-S04-B			
	Width	Depth	Height	Load cap. [kg]
	600	600	1535	600
32U	SRS-32-6/8-S04-B			
	Width	Depth	Height	Load cap. [kg]
	600	800	1535	600
32U	SRS-32-8/8-S04-B			
	Width	Depth	Height	Load cap. [kg]
	800	800	1535	600



42U	SRS-42-6/6-S04-B			
	Width	Depth	Height	Load cap. [kg]
	600	600	1980	600
42U	SRS-42-6/8-S04-B			
	Width	Depth	Height	Load cap. [kg]
	600	800	1980	600
42U	SRS-42-8/8-S04-B			
	Width	Depth	Height	Load cap. [kg]
	800	800	1980	600
42U	SRS-42-6/10-S04-B			
	Width	Depth	Height	Load cap. [kg]
	600	1000	1980	600
42U	SRS-42-8/10-S04-B			
	Width	Depth	Height	Load cap. [kg]
	800	1000	1980	600
45U	SRS-45-8/10-S04-B			
	Width	Depth	Height	Load cap. [kg]
	800	1000	2120	600
45U	SRS-45-8/10-S04-B			
	Width	Depth	Height	Load cap. [kg]
	800	1000	2120	600

Features

- Individual configuration:
 - multiple door, panel, roof options for maximum flexibility,
 - possibility to join cabinets in a row
 - levelling feet, castor or plinth options
 - individual configuration using simple coding.
- Wide range of supplementary accessories: shelves, drawers, fan units, power strips, blanking plates etc.
- Flexibility in manufacturing tailor-made cabinets
- Material:
 - frame, side panels, solid steel door, roof, mounting profiles,
 - C-profiles - sheet steel
- Protection degree: IP 20 in accordance with EN 60529 (does not apply to brush cable entries)
- Surface finishing: Frame, roof, panels, doors, plinth - powder paint, black (RAL 9005). All other color options on request. Mounting profiles, C-profiles - Al-Zn coated

Assembly set

- frame,
- safety glass front door,
- two side panels,
- steel rear door shortened with 3 U module panel with brush strip, lockable,
- standard roof, raised, with perforated sides,
- 2 pairs of 19" mounting profiles,
- earthing bar and cables,
- cabinet placed on levelling feet.

Delivery

Cabinets are delivered as fully assembled items in a secure portable carton on a wooden pallet

MAXIMUM WEIGHT OF EQUIPMENT MOUNTED IN CABINET

Levelling feet	1000 kg
Castors - type 150	150 kg
Castors - type 300	500 kg
Plinth	1000 kg*

SSRS Floor standing server cabinets

SSRS-42-6/10-S04-B				
42U	Width	Depth	Height	Load cap.[kg]
	600	1000	1980	1000

SSRS-42-8/10-S04-B				
42U	Width	Depth	Height	Load cap.[kg]
	800	1000	1980	1000

SSRS-42-8/12-S04-B				
42U	Width	Depth	Height	Load cap.[kg]
	800	1200	1980	1000

SSRS-45-6/10-S04-B				
45U	Width	Depth	Height	Load cap.[kg]
	600	1000	1980	1000

SSRS-45-8/10-S04-B				
45U	Width	Depth	Height	Load cap.[kg]
	800	1000	1980	1000

SSRS-45-8/12-S04-B				
45U	Width	Depth	Height	Load cap.[kg]
	800	1200	1980	1000

Features

- Expanded configuration system:
 - multiple door, panel, roof options for maximum flexibility,
 - possibility to join cabinets in a row,
 - possibility of optional cable entry,
 - easy coding system enables quick configuration of the cabinet.
- Possibility of controlling ventilating air flow by application of proper type of doors, side panels and fan units.
- Wide range of supplementary accessories: shelves, drawers, fan units, power strips, blanking plates etc.
- Non-standard cabinets are available on individual customer's request.
- Material:
 - Frame, side panels, doors, roof, mounting profiles, C-profiles - sheet steel
 - Outriggers - zamak casting
- Protection degree: IP 20 in accordance with EN 60529 (does not apply to brush cable entries).
- Surface finishing: Frame, roof, panels, doors - powder paint, light grey (RAL 7035) or black (RAL 9005). All other color options on request. Mounting profiles, C-profiles - Al-Zn coated.

Assembly set

- cabinet frame,
- perforated front and rear steel door (perforation type C), with three-point rod-latch lock with swing handle,
- two side panels made of unperforated steel sheets,
- standard roof (with 1 or 3 cable openings covered with knock-out blanking plates):
- 600 mm cabinets – 1 opening,
- 800 mm cabinets – 3 openings;
- - three pairs of mounting profiles, spaced at 19",
 - earthing strip and cables,
 - levelling feet.

Delivery

Cabinets are delivered as fully assembled items in a secure portable carton on a wooden pallet

MAXIMUM WEIGHT OF EQUIPMENT MOUNTED IN CABINET

Levelling feet	1360 kg*
Castors - type 300	500 kg
Plinth	1360 kg*

*Declared carrying capacity is valid if maintaining the maximum distance between mounting profiles within the cabinet. If the cabinet is set on feet, for ensuring carrying capacity you must also tighten jam nuts to the bottom plate.



SWJ Wall mount single section cabinets

SWJ-06-400-S04-B			
6U	Width	Depth	Height
	600	400	365
SWJ-10-400-S04-B			
10U	Width	Depth	Height
	600	400	543
SWJ-12-400-S04-B			
12U	Width	Depth	Height
	600	400	632
SWJ-15-400-S04-B			
15U	Width	Depth	Height
	600	400	765
SWJ-18-400-S04-B			
18U	Width	Depth	Height
	600	400	899
SWJ-06-600-S04-B			
6U	Width	Depth	Height
	600	600	365
SWJ-10-600-S04-B			
10U	Width	Depth	Height
	600	600	543
SWJ-12-600-S04-B			
12U	Width	Depth	Height
	600	600	632
SWJ-15-600-S04-B			
15U	Width	Depth	Height
	600	600	765
SWJ-18-600-S04-B			
18U	Width	Depth	Height
	600	600	899



Features

- Designed for indoor applications
- Available in 2 depths (400 and 600 mm) and 6 usable heights (from 6 to 21 U)
- The cabinet is made of bolted framework (composed of 3 frames), top plate, bottom plate, side panels, rear panel and front door
- Cabinet is equipped with two adjustable 19" mounting profiles
- Top and bottom plates have cable openings covered with knock-out blanking plates, and 3 venting holes for each plate
- Door, side panels and mounting profiles can be installed without tools
- The entire weight of the devices installed inside the cabinet is transferred onto its framework. Top and bottom plates, side panels and cabinet door can be removed or installed also with a fully equipped cabinet that is mounted to the wall
- Side panels can be removed after opening the door
- With easy replacement of doors, side panels, top and bottom plates for a different color scheme, the cabinet design can be changed multiple times
- Material: sheet steel, safety glass
- Protection degree: IP 20 in accordance with EN 60529
- Protection degree of cabinet in basic version:
 - frame, doors, panels – powder paint, light grey (RAL 7035)
 - mounting profiles – Al-Zn coated
- Maximum load capacity: The maximum weight of equipment mounted in cabinet is 100 kg

Assembly set

- 1x brush strip
- 1x set of M6 rack bolts(16 pcs)
- 2x keys for side and back wall
- 2x keys for front door
- 4x set of M10 leveling feet
- 1.5 m of special edge sheath protecting cabling (after a breaking cable grommet)

Delivery

Cabinets are delivered as fully assembled items in a secure portable carton on a wooden pallet

SWD Wall mount two section cabinets

Cabinets

U	SWD-06-500-S04-B		
	Width	Depth	Height
6U	600	500	330
U	SWD-10-500-S04-B		
	Width	Depth	Height
10U	600	500	464
U	SWD-12-500-S04-B		
	Width	Depth	Height
12U	600	500	600
U	SWD-15-500-S04-B		
	Width	Depth	Height
15U	600	500	730
U	SWD-18-500-S04-B		
	Width	Depth	Height
18U	600	500	865



Features

- Standard RAL 9005 colour (black - structure)
- IP20 protection
- Indoor use
- Wide range of additional accessories (pedestals, sockets, shelves, fan units, light units, light units, power distribution units, elements for installing and placing the cables)
- 2x holes in the top part and the bottom to install ventilation panel
- Zinc sheet pair of vertical 19" mounting profiles, mounted on horizontal profile rails with 25 mm hole spacing
- Maximum spacing between mounting profiles:
 - cabinet depth: 400 mm - 335 mm,
 - cabinet depth: 500 mm - 435 mm,
 - cabinet depth: 600 mm - 535 mm,
- Material: 1,25 mm thick steel sheet,
- Removable and lockable with single point lock side walls
- Front door with hardened glass (thickness: 3,15 mm) with single point lock, mounted on the hinges, opening angle 180° (optionally steel door)
- Left or right door opening options,
- 2x holes in the top part and bottom to insert cables (250 x 70 mm)
- Load capacity: 50 kg

Assembly set

- 1x brush strip
- 1x set of M6 rack bolts(16 pcs)
- 2x keys for side and back wall
- 2x keys for front door
- 4x set of M10 leveling feet
- 1.5 m of special edge sheath protecting cabling (after a breaking cable grommet)

Delivery

Cabinets are delivered as fully assembled items in a secure portable carton on a wooden pallet

Cabinet accessories

Cabinets

1U/ 19" shelf

RAL 9005

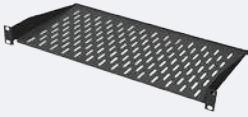

PSM-25-1U-S04-B		
Width [mm]	Depth [mm]	Load cap.[kg]
446	250	10

Features

- Material: steel sheet
- Mounted at the front
- Colour: RAL 9005 black

1U/ 19" fixed shelf - mounted in 4 points

RAL 9005

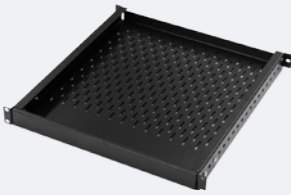

PSM-35-1U-S04-B			
Height [mm]	Width [mm]	Depth [mm]	Load cap.[kg]
22	483	350	100
PSM-45-1U-S04-B			
Height [mm]	Width [mm]	Depth [mm]	Load cap.[kg]
22	483	450	100
PSM-55-1U-S04-B			
Height [mm]	Width [mm]	Depth [mm]	Load cap.[kg]
22	483	550	100
PSM-65-1U-S04-B			
Height [mm]	Width [mm]	Depth [mm]	Load cap.[kg]
22	483	650	100

Features

- Material: steel sheet
- Mounted at the front and back in 4 points
- Colour: RAL 9005 black
- Adjustable back handles in a given mounting range

1U/19" Depth adjustable shelf

RAL 9005

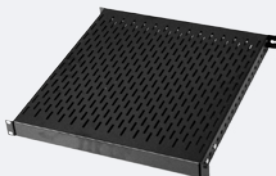

PSZ-60-1U-B	
Depth [mm]	Load cap.[kg]
350-600	150
PSZ-90-1U-B	
Depth [mm]	Load cap.[kg]
500-900	150

Features

- Steel sheet
- Mounted at the front or back
- Adjustable in depth every 25 mm
- Colour: RAL 9005 black

Fan panels

	WTD-2T-S04-B 2-fan	WTD-4T-S04-B 4-fan
Dimensions (W x D x H) [mm]	119 x 119 x 38	119 x 119 x 38
Ambient temperature [°C]	from -10 to +70	from -10 to +70
Protection degree	IP 20	IP 20
Capacity [m³/h]	330	660



Features

- Designed to be mounted in 19" cabinets
- Equipped with power protector
- Illuminated switch and thermostat with temperature control
- Material: steel sheet

Fan panels designed for wall mount cabinets



WTA-1W 1-fan module

Features

- Designed to be mounted in the top or bottom part of 19" wall mount cabinets
- Equipped with power supply cable, grounding cable and screws to mount fans
- Power supply: AC 230 V, 50 Hz

Distribution unit

3U	PDN-3U-B		
	Height [mm]	Width [mm]	Depth [mm]
	133	446	60



Features

- 19" housing for modular devices
- 1.5 mm thick sheet powder painted
- Equipped with din rail with 402.5 x 45.5 mm opening
- Maximum quantity: 18 built-in modules S type (width: 17.5 mm)
- Material: 1.5 mm steel sheet

Base designed for 19" server cabinet with integrated tilt protection

CKP-6/10-S04-B				
Width [mm]	Depth [mm]	Height [mm]	Weight [kg]	Load cap.[kg]
600	1000	100	23	100
CKP-8/10-S04-B				
Width [mm]	Depth [mm]	Height [mm]	Weight [kg]	Load cap.[kg]
800	1000	100	25.5	100
CKP-8/12-S04-B				
Width [mm]	Depth [mm]	Height [mm]	Weight [kg]	Load cap.[kg]
800	1200	100	25.5	100

Features

- Designed to be mounted with 19" cabinets
- Material: steel sheet
- Equipped with integrated tilt protection
- Can be used in combination with leveling feet



Leveled base for 19" standing cabinet

Code	Height [mm]	Width [mm]	Depth [kg]	Load cap.[kg]
CKR-6/6-S04-B	100	600	600	100
CKR-6/8-S04-B		600	800	
CKR-8/6-S04-B		800	600	
CKR-8/8-S04-B		800	800	
CKR-6/10-S04-B		600	1000	
CKR-8/10-S04-B		800	1000	
CKR-8/12-S04-B		800	1200	

Features

- Designed to be mounted with SRS and SSRS 19" cabinets
- Leveling feet
- The set consists of the given elements that are ordered separately:
 - 100 mm base
 - 4 corners with leveling feet
 - 4 shackles (plain, perforated or with brush panel)



Base designed for 19" standing cabinet

Code	Height [mm]	Width [mm]	Depth [kg]	Load cap.[kg]
CKS-6/6-S04-B	100	600	600	100
CKS-6/8-S04-B		600	800	
CKS-8/6-S04-B		800	600	
CKS-8/8-S04-B		800	800	
CKS-6/10-S04-B		600	1000	
CKS-8/10-S04-B		800	1000	
CKS-8/12-S04-B		800	1200	

Features

- Designed to be mounted with SRS 19" cabinets
- Can be used in combination with leveling feet or wheels
- Perforated front plate
- Base height can be increased to 200 mm by screwing two bases together



Cable arrangement

Cabinets

19" Horizontal cable organizer

with easily-opened plastic handles

ORG-VP-1U-B-V2



Clip



4-6 holders



Horizontal organizer

Features

- 19" mounting
- Powder painted steel
- Equipped with 4 easily opened-handles
- Possibility of installing 2 extra handles
- Clear manufacturer marking
- Possibility of using together with vertical organizers
- Guarantee optimum cable arrangement

19" Vertical cable organizer

with easily-opened plastic handles

ORG-HP-1U-B-V2



Clip



4 holder positions



Vertical organizer

Features

- 1U mounting
- Powder painted steel
- Equipped with 1 easily opened-handle
- Possibility of using holder in 4 positions
- Clear manufacturer marking
- Guarantee optimum cable arrangement

Velcro tape

16x200 10 pcs

FIBRAIN velcro tapes

ORG-CT-16200-BK
black

ORG-CT-16200-W
white



Features

- Material: velour
- Guarantee optimum cable arrangement
- Pack of 10 pcs
- Width: 16 mm- protected against excessive tightening
- Resistant to multiple opening and closing
- Colours facilitate cable identification

Power distribution units

Cabinets

PDU-5BL			
Qty and type of sockets	Plug	Extra elements	Max. electrical load
5 x Jacket with pin	UNISCHUKO	LED switch	16 A (3680 W)
PDU-8BL			
Qty and type of sockets	Plug	Extra elements	Max. electrical load
8 x Jacket with pin	UNISCHUKO	LED switch	16 A (3680 W)
PDU-9AB			
Qty and type of sockets	Plug	Extra elements	Max. electrical load
9 x Jacket with pin	IEC320C14	-	16 A (3680 W)
PDU-9BB			
Qty and type of sockets	Plug	Extra elements	Max. electrical load
9 x Jacket with pin	UNISCHUKO	-	16 A (3680 W)
PDU-9SB			
Qty and type of sockets	Plug	Extra elements	Max. electrical load
9 x Jacket z SCHUKO	UNISCHUKO	-	16 A (3680 W)

Features

- Anodized aluminium housing
- Dimensions: 431x44x44 mm (Width x Height x Depth) (without mounting supports)
- Panels adjusted to 1U 19" mounting
- Panels can be mounted vertically
- Equipped with M6 rack bolts
- Socket with pin have protection against accidental placement of other items
- H05W-F-3G 1.5 mm supply cable, width: 3 m
- IP20 protection
- In accordance with CE Standards
- Tailor-made construction

Ordering options

Sockets qnt		Connector/socket type			Distribution unit type	
Qty	Mounting	Number	Connector	Socket	Number	Equipment
5-9	in 19" housing	B	UNISCHUKO	with pin	B	No extra equipment
A - 10 sck.	Vertical mounting	S	UNISCHUKO	Schuko	L	LED switcher
B - 11 sck.		C	UNISCHUKO	C13	P	Surge protection
C - 12 sck.		D	UNISCHUKO	C19	F	Interference eliminator
		A	C14	with pin	A	Surge protection + Int.el.
		E	C14	Schuko	C	LED switcher + Surge protection + Int.el.
		F	C14	C13	D	LED switcher + Surge protection
		G	C14	C19	E	LED switcher + Int.el.

PDU - 8AL



Optional accessories

- Two-positional LED illuminated switcher
- Extra set of handles to facilitate vertical mounting on an outer part of housing
- Tailored made sockets options
- Adjusted length of a supply cable and a connector
- Ammeter - power meter

Surge protection

- Reaction time <25 ns
- Absorption of surge energy: 303 J (impulse 10/1000 ns)
- Nominal impulse of power: 7 kA
- Maximum power impulse 10 kA(udar 8/20 ns)

Interference eliminator

Max. electrical load					
f [MHz]	0.15	1	4.7	10	30
symmetrical mode					
A [dB]	29	42	30	47	43
assymetrical mode					
A [dB]	25	62	64	43	22





LOGIWIRE

LOGIWIRE

Tailor-made teleinformatic mini-unit inside



EASY TO INSTALL
WM and FM versions



MODULAR CONSTRUCTION
Tailor made residential
cabling solution



MODULAR DIMENSIONS
available in 4 variants



**STANDARD
AND PREMIUM LINE**
Solution for
all demands

your apartment



**ANALOGUE/DIGITAL
VOICE MODULE**

Tailor made residential
cabling solution



DATA MODULE

DATA cable termination
on modules in accordance
with 5e or 6 cat.



SIGNAL INTEGRATION

Multimedia box facilitates
one-solid cabling topology



COMPLIANCE

Full compliance with necessary
norms and regulations

LogiWire Distribution Box flush mount option



Description

→ FIBRAIN LogiWIRE system is a demarcation point between external and internal telecommunication installations. It is dedicated for residential and small office areas. Distribution boxes are the key element of whole LogiWIRE system.

Features

- Flush mounted version
- Frame and door made of plastic (white)
- Effective WiFi transmission
- Perforated mounting plate for easy installation
- Dedicated areas for different types of inserts
- Right or left hand door

Assembly set

- Plastic frame
- Door made of plastic (white or transparent)
- FO termination outlet VFTO-E1
- 2x FO S.C/APC Simplex adapter
- Adapter for 2x keystone connection module, 2x F2F
- 2x keystone, unshielded Cat5 connection modules
- Power supply socket 1x230V

Technical specification

Dimensions [mm]			
Width	Height	Depth	Option
370	270	115	Flush mounted

Ordering information

Code	Description
FLW-ECO-FM-W	LogiWire Distribution Box, flush mounted, ECO line

Additional accessories

Code	Description
FLW-APKF-M3	Adapter for 2x keystone connection module, 2x F2F
FLW-PU-M1	Power supply socket 1x230V
VFTO-E1-BL-0	FO termination outlet VFTO-E1

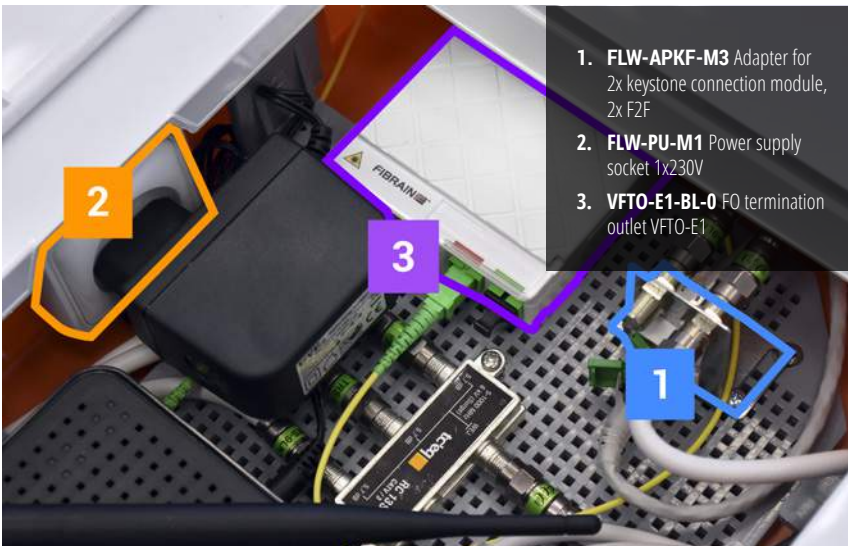

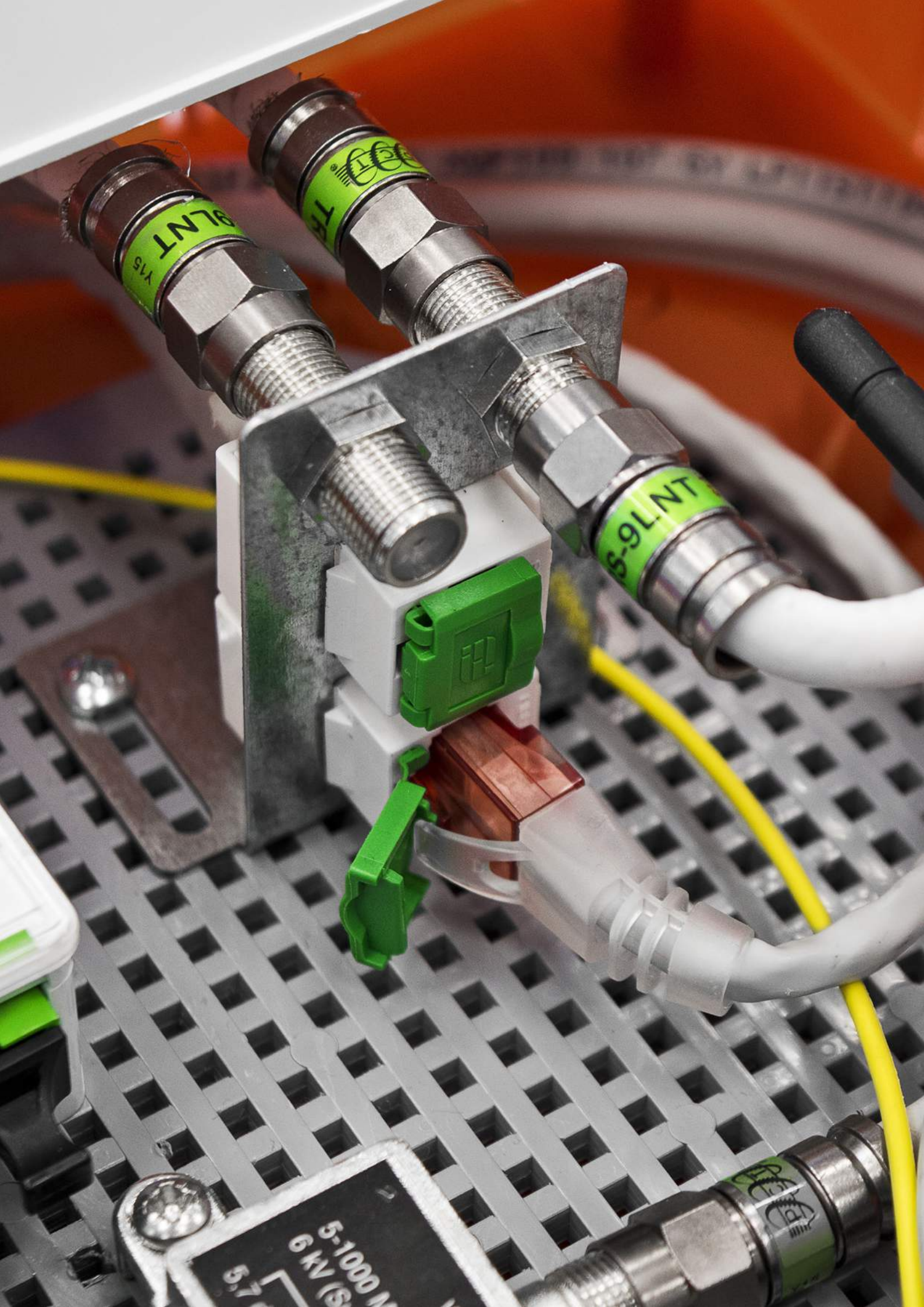

N76-9
Y15

N76-9

N76-8

5-1000 N
6 KV (S)
5.7

Mounting boxes - wall mount option

MINI Wall mount box FLW-10N-WM

Dimensions [mm]			
Length	Height	Depth	Rim
370	270	115	-
Cable entries [mm]			
Left/right	Up/down	Back	
-	-	4x Φ 50 pass	



Features

- Media and devices integration (TEL, Audio, TV, ALARM, INTERCOM, CCTV, DATA)
- Material: powder-coated steel sheet
- Simple mounting (a lot of cable entries)
- Equipped with a lock
- Boxes in other dimensions available
- Left or right mounting
- Horizontal or vertical module mounting
- Compliance with TIA 570-B standard

MIDI Wall mount box FLW-14N-WM

Dimensions [mm]			
Length	Height	Depth	Rim
370	370	115	-
Cable entries [mm]			
Left/right	Up/down	Back	
-	-	4x Φ 50 pass	



MAXI Wall mount box FLW-28N-WM

Dimensions [mm]			
Length	Height	Depth	Rim
370	720	115	-
Cable entries [mm]			
Left/right	Up/down	Back	
-	-	8x Φ 50 pass	



MAXI-LONG Wall mount box FLW-48N-WM

Dimensions [mm]			
Length	Height	Depth	Rim
370	1220	115	-
Cable entries [mm]			
Left/right	Up/down	Back	
-	-	14x Φ 50 pass	



Mounting boxes - flush mount option

Flush mount box MINI FLW-10N-EH

Dimensions [mm]			
Length	Height	Depth	Rim
370	270	100	434x324
Cable entries [mm]			
Left/right	Up/down	Back	
1x Φ 50 knockout	4x Φ 50 knockout	4x Φ 50 pass	



Features

- Media and devices integration (TEL, Audio, TV, ALARM, INTERCOM, CCTV, DATA)
- Material: powder-coated steel sheet
- Simple mounting (a lot of cable entries)
- Equipped with a lock
- Boxes in other dimensions available
- Left or right mounting
- Horizontal or vertical module mounting
- Compliance with TIA 570-B standard

Flush mount box MIDI FLW-14N-EH

Dimensions [mm]			
Length	Height	Depth	Rim
370	370	100	434x424
Cable entries [mm]			
Left/right	Up/down	Back	
1x Φ 50 knockout	4x Φ 50 knockout	4x Φ 50 pass	



Flush mount box MAXI FLW-28N-EH

Dimensions [mm]			
Length	Height	Depth	Rim
370	720	100	434x774
Cable entries [mm]			
Left/right	Up/down	Back	
2x Φ 50 knockout	4x Φ 50 knockout	8x Φ 50 pass	



Flush mount box MAXI-LONG FLW-48N-EH

Dimensions [mm]			
Length	Height	Depth	Rim
370	1220	100	434x1274
Cable entries [mm]			
Left/right	Up/down	Back	
3x Φ 50 knockout	4x Φ 50 knockout	14x Φ 50 pass	



Mounting modules - data

LogiWIRE

8xRJ45 UTP Cat.5e module FLW-DM5-U8

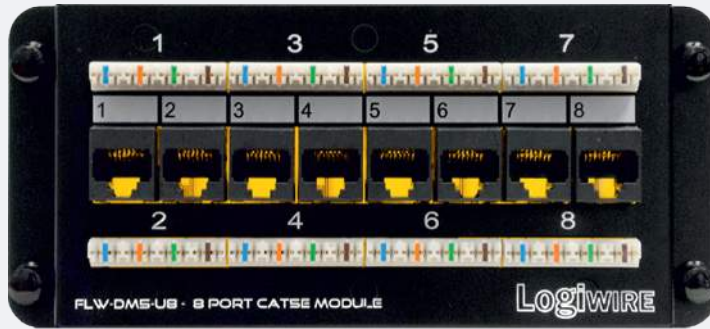

Features

- 8-pin IDC connector, 8 ports RJ45 Cat.5e
- Powder painted RAL 9005
- Cable form scheme: T568A/B

Parameters

- RJ45 Cat.5e socket
- Socket durability > 750 connection cycles
- Contacts of 0.46 mm diameter covered with gold layer
- IDC connectors accept 22-26 AWG wire
- Cable form scheme: T568A and T568B

Standards

- Permanent Link/Channel in accordance with TIA/EIA 568B-2.1
- ISO/IEC 11801
- CENELEC EN 50173
- IEC 60603-7

8xRJ45 UTP Cat.6 module FLW-DM6-U8

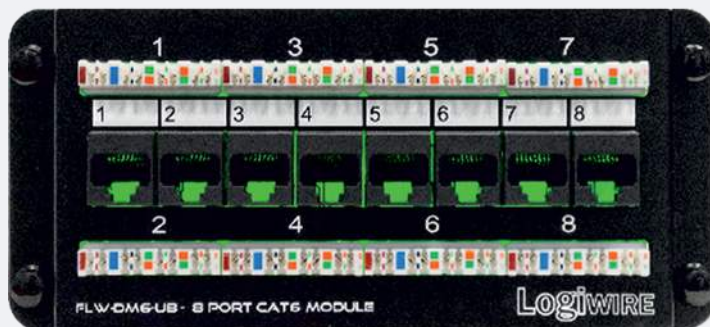

Features

- 8-pin IDC connector
- 8 ports RJ45 Cat.6
- Powder painted RAL 9005
- Cable form scheme: T568A/B

Parameters

- RJ45 Cat.6 socket
- Socket durability > 750 connection cycles
- Contacts of 0.46 mm diameter covered with gold layer
- IDC connectors accept 22-26 AWG wire
- Cable form scheme: T568A and T568B

Standards

- Permanent Link/Channel in accordance with TIA/EIA 568B-2.1
- ISO/IEC 11801
- CENELEC EN 50173
- IEC 60603-7

Mounting modules - voice

Premium line

RJ45, 8pins IDC, 8x8pins IDC module FLW-OPT-I8

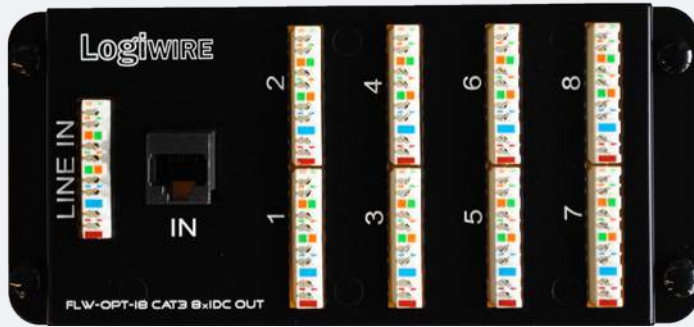

Features

- 8-pin IDC connector, RJ-45 input
- 8x8pins IDC output
- Powder painted RAL 9005
- Cable form scheme: T568A/B
- Up to 4 telephone lines support on port

Parameters

- IDC/RJ45 socket
- Socket durability> 750 connection cycles
- IDC connectors accept 22-26 AWG wire
- Cable form scheme: T568A and T568B

RJ45, 8pins IDC, 8xRJ45 module FLW-OPT-R8

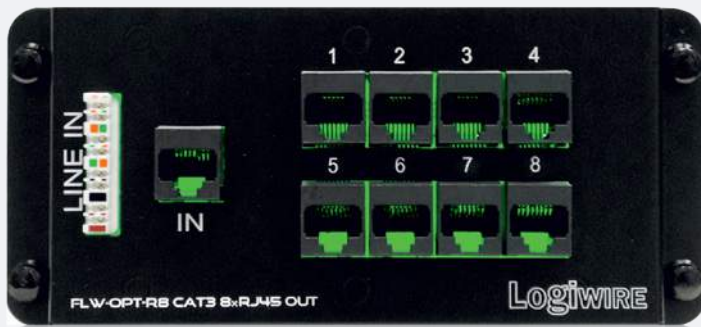

Features

- 8-pin IDC connector, RJ-45 input
- 8x8pins IDC output
- Powder painted RAL 9005
- Cable form scheme: T568A/B
- Up to 4 telephone lines support on port

Parameters

- IDC/RJ45 socket
- Socket durability> 750 connection cycles
- IDC connectors accept 22-26 AWG wire
- Cable form scheme: T568A and T568B

Mounting modules - accessories

Mounting module FLW-BMP-M1

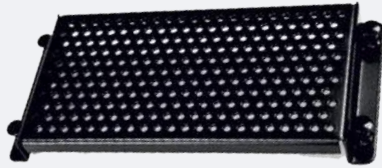

Features

- Enables installation any teleinformatic component
- Facilitates development of LogiWire solutions
- Equipped with installation sieve (openings: 2.8 mm)

Support panel FLW-ABP-M1

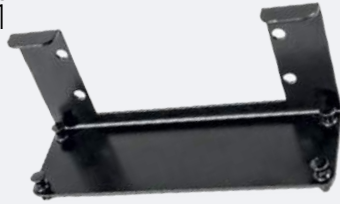

Features

- Enables installation of extra panels and adapters
- Facilitates development of LogiWire solutions for "keystone" modules, F-connector
- Adapted to mount 2 panels of adapters

Adapters



6x keystone panel
FLW-APK-M6

4x keystone panel
FLW-APK-M4

6x F-connector panel
FLW-APFF-M4

Features

- Facilitates mounting "keystone" adapters
- Design to construct indirect connection for transmission media
- 4 or 6 openings to mount "keystone" adapters
- 6 openings to mount FtoF

Masking panels with holes FLW-BMP-T2



Features

- Cover extra cables inside mounting box
- Protect cables against damage
- Height of cable entry: 30 mm
- 2 cable entries
- Mounting openings for masking frames

Power distribution units PDU-2BB



Features

- 2x socket with pin
- Cable terminated with power unit
- Max. electrical load 16 A

1**GPON Modules**

It is a passive fiber optic network in which signal is sent to particular users with the use of single-mode optical fiber separated by splitters.

2**Phone modules**

Phone panel multiplies the entering signals. There is a possibility of termination 4 entering lines out of 8 RJ45ports or IDC connection.

3**DATA Modules**

DATA modules (cat. 5e, 6) are used for termination installation cables inside the buildings. They function as a patch panel in a minimized form, which is designed for housing market.

4**Fiber optic modules**

By using termination elements from Fibrain fiber optic systems- the system is ready for implementation complete solution from the transmitting station.

5**Connecting elements**

Specially selected short sections of patch panel cables enable proper arrangement of cables. 2 levels of termination facilitates separating cables.

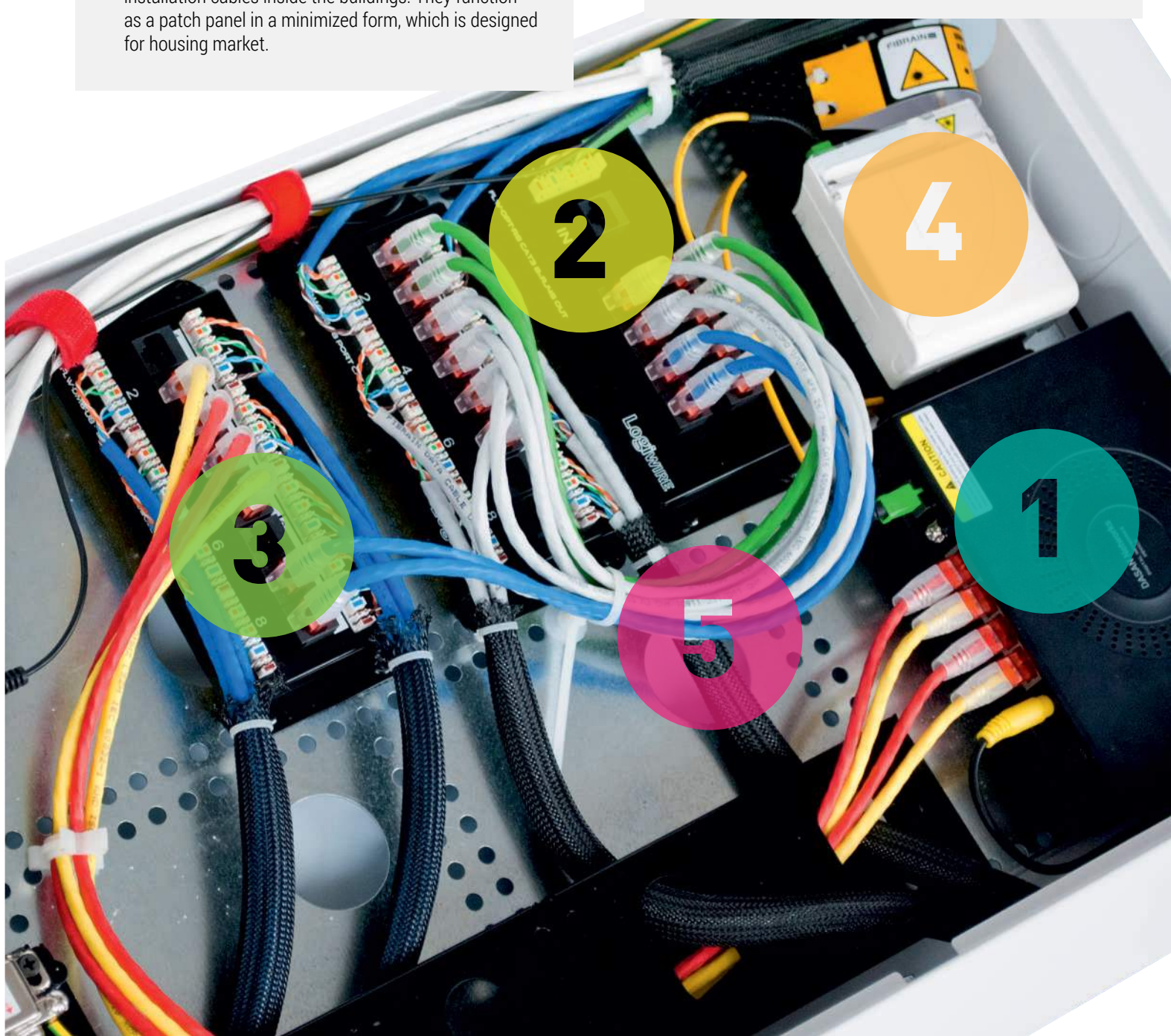

**FIBER
OPTIC**



FIBRAINDATA

INSTALLATION CABLES

Fiber optics installation cables for today's



MM FIBERS
OM1-OM4 categories



SM FIBERS
OS1/OS2 categories



**INDOOR
AND OUTDOOR
APPLICATIONS**
Variety of external
jackets LSOH/HDPE

INSTALLATION CABLES

and future application



READY FOR HARSH ENVIRONMENT

Rodent and mechanical protection



EASY TO TERMINATE

Special construction friendly for the installers



TRUE COLORS

Color coding for fibers, tubes and jackets



BENDSAFE

Perfect cables for space restricted areas

Duplex ZIP cables

DATACOM

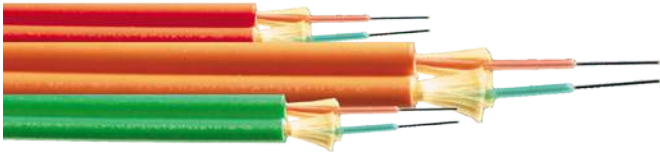

LSOH



Bendsafe



Easy to terminate



Easy-strip



Semi-tight



Cable structure

1. LSOH outer jacket
2. Aramid yarns
3. Central tight buffer Tube 600/900 µm with colored fibers 250 µm

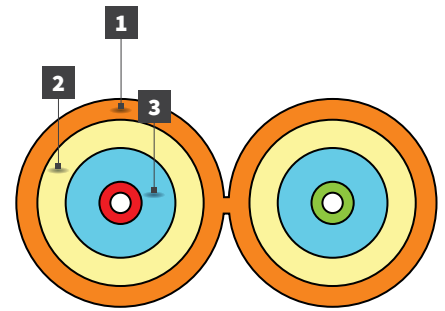

CONSTRUCTION

Version	Fiber qty	Dimensions nominal ± 5% [mm]	Max. installation tension (ε=0.5 %) [N]	Crush [N/10 cm]
2F	2	1.6 x 3.3	200	500
2F	2	1.8 x 3.7	300	500
2F	2	2.0 x 4.1	400	500
2F	2	2.8 x 5.7	600	1000

STANDARD JACKET COLOURS

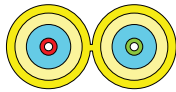

SM G.652D
Yellow RAL 1021

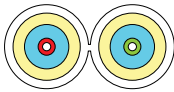

SM G.657
A1 / A2 / A3
White RAL 9010

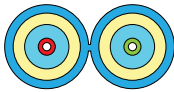

MM 62,5/125 OM1
Blue RAL 5015

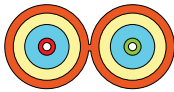

MM 50/125 OM2
Orange RAL 2003

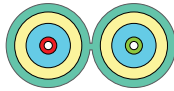

MM 50/125 OM3
Aqua RAL 6027

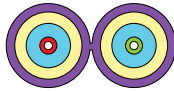

MM 50/125 OM4
Violet RAL 4003

Applications

- Distribution systems cable
- Patchcords and pigtails
- Terminals connection

Construction

- LSOH with low coefficient of friction
- Aramid yarns
- 250 µm coloured fibers

TEMPERATURE CHARACTERISTICS

Storage Temperature [°C]	-40 to +70
Operating Temperature [°C]	-10 to +70
During installation [°C]	-5 to +55

SM low-radius bending resistance

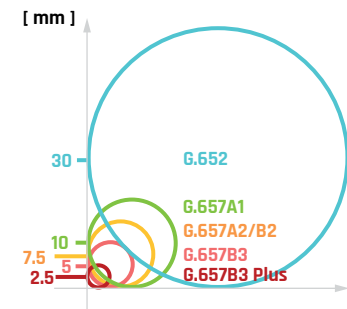

LDC cables

DATACOM



Cable structure

1. Outer jacket LS0H UV stabilized
2. Tight tubes 900 µm (LS0H) with colored fibers 250 µm
3. Aramid yarns

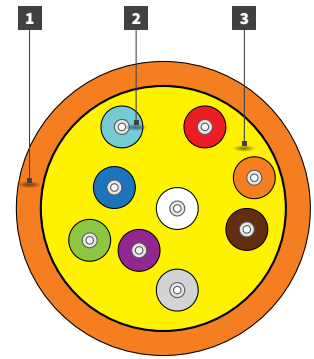

LSOH



Bendsafe



Easy to terminate



Easy-strip



Semi-tight



Datacenter



CONSTRUCTION						
Version	Tight buffers [pcs]	Ø ± 5% [mm]	Nominal weight LS0H ± 5% [kg/km]	Max. tensile load [N]		Crush [N/10 cm]
				installation	operation	
2F	2	4.5	21	500	125	500
4F	4	5.0	26			
6F	6	5.5	30			
8F	8	5.5	35			
10F	10	6.5	40	700	175	500
12F	12	6.5	45			
16F	16	7.0	50			
24F	24	8.0	65	1000	250	

- ### Applications
- Indoor/outdoor installations
 - Distribution networks in multifamily buildings
 - FTTH Connections
 - Distribution systems
 - Fully dielectric
 - LAN and FTTH network
 - ODF connection
 - Datacenter distribution

STANDARD JACKET COLOURS												
D-DATACOM (ACCORDING TO DIN VDE 0888 & IEC 60304) - Fibers & Buffers												
1-12	1	2	3	4	5	6	7	8	9	10	11	12
Fiber	Red	Green	Blue	Yellow	White	Grey	Brown	Violet	Aqua	Black	Orange	Pink
Buffer	Red	Green	Blue	Yellow	White	Grey	Brown	Violet	Aqua	Black	Orange	Pink
Colour 250/600/900 µm	red	green	blue	yellow	white	grey	brown	violet	aqua	black	orange	pink
13-24	13	14	15	16	17	18	19	20	21	22	23	24
Fiber	Red	Green	Blue	Yellow	White	Grey	Brown	Violet	Aqua	Natural	Orange	Pink
Code	Red	Green	Blue	Yellow	White	Grey	Brown	Violet	Aqua	Green	Orange	Pink
Colour 250 µm	red	green	blue	yellow	white	grey	brown	violet	aqua	natural	orange	pink
Colour* 600/900 µm	red	green	blue	yellow	white	grey	brown	violet	brown	dark green	orange	pink

- ### Construction
- Compact design
 - Lightweight
 - Flexible
 - Easy to strip
 - Fully dielectric
 - Reduced diameter
 - Direct connectorization

TEMPERATURE CHARACTERISTICS	
Storage Temperature [°C]	-40 to +70
Operating Temperature [°C]	-10 to +70
During installation [°C]	-5 to +55

*Buffer with black mark to identify fibers 13-24

LBR cables

DATA COM



Cable structure

1. Outer jacket LSOH UV stabilized
2. Subcables 1.8 mm with tight tubes 900 μm (LSOH) with 250 μm colored
3. Aramid yarns
4. Central FRP strength member
5. Ripcord

fibers

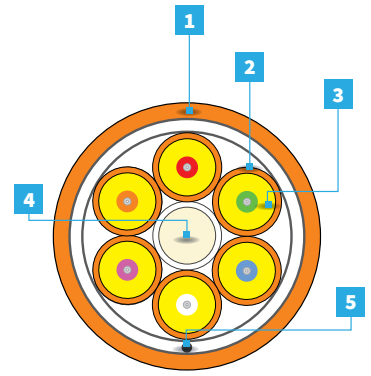

LSOH



Bendsafe



Easy to terminate



Easy-strip



Semi-tight



Datacenter



TRUE COLORS

CONSTRUCTION

Version	Fiber qty	Dimensions nominal ± 5% [mm]	Max. installation tension (ε=0.5%) [N]	Crush [N/10 cm]
2F	2	1.6 x 3.3	200	500
2F	2	1.8 x 3.7	300	500
2F	2	2.0 x 4.1	400	500
2F	2	2.8 x 5.7	600	1000

STANDARD JACKET COLOURS



PE Black RAL9005

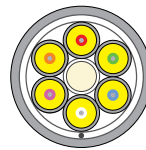

LSOH Grey RAL7022

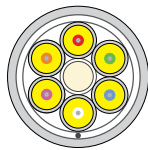

LSOH Light Grey RAL7037

OUTER JACKET COLOUR OPTIONS

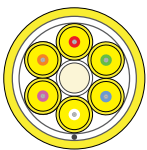

SM G.652D RAL 1021

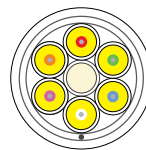

SM G657A1, A2, A3 RAL 9010

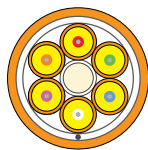

MM 50/125 OM2 RAL 2003

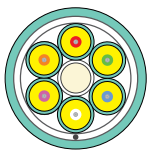

MM 50/125 OM3 RAL6027

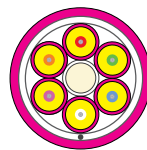

MM 50/125 OM4 RAL4003

Fiber Optic Solutions

Applications

- Indoor/outdoor installations
- Distribution networks in multifamily buildings
- FTTH Connections
- Distribution systems
- Fully dielectric
- LAN and FTTH network
- ODF connection
- Datacenter distribution

Construction

- Simplex sub cable up to 24 fibers
- Fully dielectric cable
- Aramid yarns as tensile elements
- UV Resistant and LSOH flame retardant outer jacket

TEMPERATURE CHARACTERISTICS

Storage Temperature [°C]	-40 to +70
Operating Temperature [°C]	-20 to +70
During installation [°C]	-5 to +55

DC-PRIM cables

DATACOM



LS0H



Bendsafe



Easy to terminate



Datacenter



Cable structure

1. LS0H outer jacket
2. Aramid yarns
3. 250 µm optical fibers

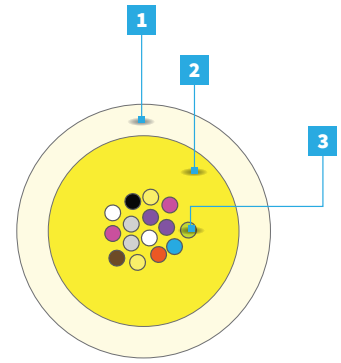

CONSTRUCTION

No. of fibers	12	24
Outer diameter [mm] (±5%)	3.0	3.5
Max tensile load (ε=0.5%) [N]	350	350
Weight [kg/km] (±10%)	8	9
Crush [N/10 cm]	350	
Min. bend radius [mm]	45 (depends on fiber type)	60 (depends on fiber type)

OUTER JACKET COLOUR OPTIONS

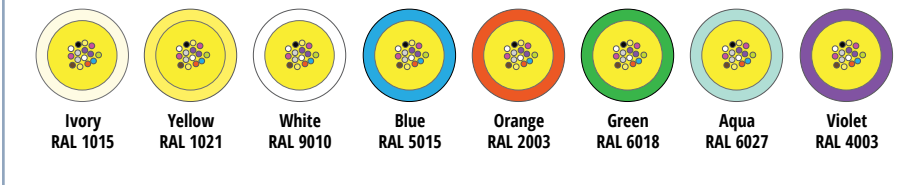

AVAILABLE FIBER COLOURS

D-DATACOM (ACCORDING TO DIN VDE 0888 & IEC 60304)

	1-12	1	2	3	4	5	6	7	8	9	10	11	12
Fiber													
Colour		red	green	blue	yellow	white	grey	brown	violet	aqua	black	orange	pink
	13-24	13	14	15	16	17	18	19	20	21	22	23	24
Fiber													
Code													
Colour*		red	green	blue	yellow	white	grey	brown	violet	brown	dark green	orange	pink

*Fiber with black mark to identify fibers 13-24

Applications

- Optical cable with aramid yarns reinforcement
- Customer connection, fully dielectric cable
- MTP/MPO termination cable
- LAN and FTTX networks
- Distribution network
- Inside house OLT connection
- Data Center connections cable

Construction

- Aramid strength element
- 250 µm optical fibers (12-24)
- LS0H outer jacket

TEMPERATURE CHARACTERISTICS

Storage Temperature [°C]	-40 to +70
Operating Temperature [°C]	-10 to +70
During installation [°C]	-5 to +55

EXO-GU cables

DATACOM

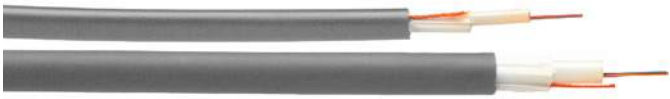

Cable structure

1. LSOH outer jacket
2. Central loose tube (PBT) with colored fibers in filling compound
3. Optical fibers
4. Fiberglass yarns
5. Ripcord



Datacom



Compact design



LSOH



Basic Rodent Protection

CONSTRUCTION							
Version	Fiber qty	Fibers per tube	Ø ± 5% [mm]	Nominal weight LSOH ± 5% [kg/km]	Max. tensile load [N]		Crush [N/10 cm]
					installation	operation	
1T x 2F	2	2	5.8	34	1200 (ε=0,33%) 1500 (ε=0,5%)	400	1500
1T x 4F	4	4	5.8	34			
1T x 6F	6	6	5.8	35			
1T x 8F	8	8	5.8	35			
1T x 12F	12	12	5.8	35			
1T x 16F	16	16	5.8	35			
1T x 18F	18	18	5.8	36			
1T x 24F	24	24	5.8	36			

Applications

- Fully dielectric cable
- Basic rodent protection
- LAN and FTTX networks
- Distribution network
- ODF connections

Construction

- Central Loose tube (PBT) with filling compound
- Optical fibers
- Fiberglass as water absorbent and strain relief element
- LSOH outer jacket

AVAILABLE FIBER COLOURS												
D-DATACOM (ACCORDING TO DIN VDE 0888 & IEC 60304) - Fibers												
1-12	1	2	3	4	5	6	7	8	9	10	11	12
Code												
Colour	red	green	blue	yellow	white	grey	brown	violet	aqua	black	orange	pink
13-24	13	14	15	16	17	18	19	20	21	22	23	24
Code												
Colour	red	green	blue	yellow	white	grey	brown	violet	aqua	dark green	orange	pink

TEMPERATURE CHARACTERISTICS	
Storage Temperature [°C]	-20 to +70
Operating Temperature [°C]	-20 to +70
During installation [°C]	-5 to +55

*In 24-fiber tube construction colours will be repeated to facilitate identification, fibers 13-24 will have rings every 25 cm;

Jacket colours

Standard



PE Black RAL 9005



LSOH Grey RAL 7022

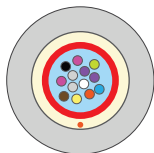

LSOH Light Grey RAL 7037

Fiber identification

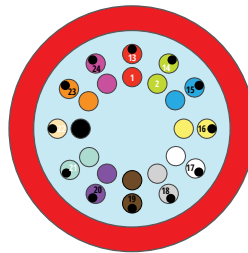

Optional



SM G.652D RAL 1021

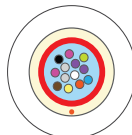

SM G657 A1, A2, A3 RAL 9010

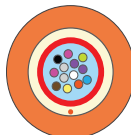

MM 50/1025 OM2 RAL 2003

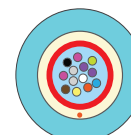

MM 50/1025 OM3 RAL 6027



MM 50/1025 OM4 RAL 4003

BDC-MSA cables

DATACOM



Cable structure

1. LSOH outer jacket
2. Water-blocking fiberglass yarns
3. Water blocking yarns
4. PET tape
5. Central strength member (FRP)
6. Loose tubes (PBT) with colored fibers in filling gel
7. Fillers
8. Ripcord

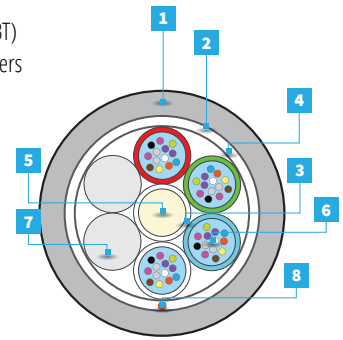





Datacom



ETR



Compact design



LSOH



Basic Rodent Protection



Datacenter

CONSTRUCTION										
Version	Fibers	Fibers per tube	Total elements	Active tubes	Ø ± 5% [mm]	Nominal weight PE ±5% [kg/km]	Nominal weight LSOH ±5% [kg/km]	Max. tensile load [N]		Crush [N/10 cm]
								instal-lation	oper-ation	
1T x 12F	12	12	6	1	8.2	50	65	1500	550	1500
2T x 6F	12	6	6	2	8.2	50	65	1550	780	
2T x 12F	24	12	6	2	8.2	51	65	1500	550	
4T x 6F	24	6	6	4	8.2	51	66	1550	780	
3T x 12F	36	12	6	3	8.2	52	67	1500	550	
6T x 6F	36	6	6	6	8.2	53	68	1550	780	
4T x 12F	48	12	6	4	8.2	53	68	1500	550	
5T x 12F	60	12	6	5	8.2	54	69	1500	550	
6T x 12F	72	12	6	6	8.2	54	69	1500	550	
8T x 12F	96	12	8	8	9.3	71	86	1620	750	
12T x 12F	144	12	12	12	11.5	104	126	1620	850	

Applications

- Fully dielectric cable
- Basic rodent protection
- LAN and FTTX networks
- Distribution network
- ODF connections

Construction

- FRP strength and anti-buckling element
- Optical fibers
- Loose tube with filling compound (PBT Ø 1.8 mm)
- Dry yarns to prevent moisture into the cable
- Fiberglass as water absorbent and strain relief element
- UV stabilized LSOH jacket

AVAILABLE FIBER COLOURS												
D-DATACOM (ACCORDING TO DIN VDE 0888 & IEC 60304) - Fibers												
1-12	1	2	3	4	5	6	7	8	9	10	11	12
Code	■	■	■	■	■	■	■	■	■	■	■	■
Colour	red	green	blue	yellow	white	grey	brown	violet	aqua	black	orange	pink

TEMPERATURE CHARACTERISTICS	
Storage Temperature [°C]	-40 to +70
Operating Temperature [°C]	-20 to +70
During installation [°C]	-5 to +55

D-DATACOM (ACCORDING TO DIN VDE 0888 & IEC 60304) - Tubes												
Tube	1	2	3	4	5	6	7	8	9	10	11	12
Code	■	■	■	■	■	■	■	■	■	■	■	■
Colour	red	green	blue	yellow	white	grey	brown	violet	aqua	black	orange	pink

*In case of lower fiber count some tubes can be replaced by fillers.

EAC-RAs cables

FTTH

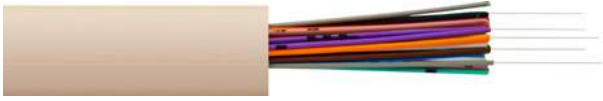

Last mile connection outdoor

LSOH

Flexible

Bendsafe

Easy to terminate

FTTH

Cable structure

1. LSOH outer jacket
2. Dielectric strength members
3. 900 µm semi tight buffer (LSOH) with colored 250 µm optical fiber

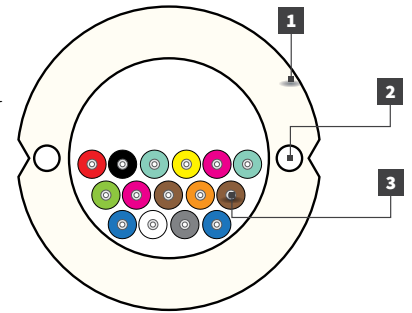

CONSTRUCTION						
Version	Fibers	Buffers	Ø ± 5% [mm]	Nominal weight ±5% [kg/km]	Max. tensile load [N]	Crush [N/10 cm]
					installation	
8F	8	8	8.7	68	400	1000
12F	12	12	8.7	72	400	
16F	16	16	12.0	98	600	
24F	24	24	12.0	106	600	

Applications

- Distribution cable
- For laying in risers
- FTTH feeder
- Easy access and installation

Construction

- FRP strength members inside cable jacket
- Optical fibers in bundles
- 2-24 elements in cable
- LSOH UV resistant outer jacket (ivory by default, various colours available)

AVAILABLE COLOURS												
F-FTTH (ACCORDING TO DIN VDE 0888 & IEC 60304)												
1-12	1	2	3	4	5	6	7	8	9	10	11	12
Fiber	■	■	■	■	■	■	■	■	■	■	■	■
Buffer	■	■	■	■	■	■	■	■	■	■	■	■
Colour 250 µm	red	blue	green	yellow	violet	white	orange	grey	brown	black	aqua	pink
Colour 600/900 µm	red	blue	green	yellow	violet	white	orange	grey	brown	black	aqua	pink
13-24	13	14	15	16	17	18	19	20	21	22	23	24
Fiber	■	■	■	■	■	■	■	■	■	■	■	■
Code	■ ■	■ ■	■ ■	■ ■	■ ■	■ ■	■ ■	■ ■	■ ■	■	■ ■	■ ■
Colour 250 µm	red	blue	green	yellow	violet	white	orange	grey	brown	black	aqua	pink
Colour* 600/900 µm	red	blue	green	yellow	violet	white	orange	grey	brown	dark green	aqua	pink

TEMPERATURE CHARACTERISTICS	
Storage Temperature [°C]	-40 to +70
Operating Temperature [°C]	-20 to +70
During installation [°C]	-5 to +55

*Buffer with black mark to identify fibers 13-24

DAC-BURRY cables

FTTH



Direct buried



FTTH



Last mile connection outdoor



Hi-crush



Compact design

Cable structure

1. PP/HDPE outer jacket
2. Aramid yarns
3. Central loose tube (PBT) with 250 µm colored fibers in filling gel
4. Dielectric strength members in the jacket

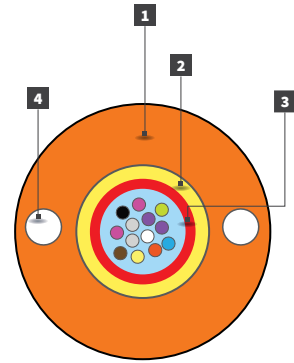

CONSTRUCTION							
Version	Fibers	Fibers per tube	Ø ± 5% [mm]	Nominal weight PE ± 5% [kg/km]	Max. tensile load [N]		Crush [N/10 cm]
					installation	operation	
1T x 2F	2	2	6.2	32	650	250	3500
1T x 4F	4	4	6.2	32			
1Tx 6F	6	6	6.2	32			
1T x 8F	8	8	6.2	32			
1T x 12F	12	12	6.2	32			

Applications

- Optical access cable with aramid yarns reinforcement
- Direct buried design
- Fully dielectric cable
- Last mile connection
- High crush resistance (3,5kN)
- Installation into existing ducts or direct buried

Construction

- Central Loose tube (PBT) with filling compound
- Up to 12 optical fibers (250 µm)
- Aramid yarns as strain relief and water absorbent
- Embedded FRP strength members
- Highly resistant outer jacket made of hard polyolefin material, UV resistant

AVAILABLE COLOURS												
T-TELECOM (ACCORDING TO IEC 60304) - FIBERS IN TUBE												
1-12	1	2	3	4	5	6	7	8	9	10	11	12
Code	■	■	■	■	■	■	■	■	■	■	■	■
Colour	red	green	blue	white	violet	orange	grey	yellow	brown	pink	black	aqua

TEMPERATURE CHARACTERISTICS

Storage Temperature [°C]	-40 to +70
Operating Temperature [°C]	-40 to +70
During installation [°C]	-15 to +55

FIBER
OPTIC



CONNECTION

CONNECTION HARDWARE

Full range of connection varieties complying



VARIETY OF FO
ADAPTERS



ONE-PIECE
TECHNOLOGY



MM AND SM



STANDARD
PREMIUM
PREMIUM SUPER

DIFFERENT
QUALITY LEVELS

Fulfill all expectations

HARDWARE

to the customer expectations



**THE HIGHEST
PERFORMANCE
AND DURABILITY**

**TRUE
COLORS**



TRUE COLORS
For efficient color
coding

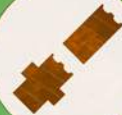

**FLANGE &
FLANGELESS
DESIGN**



**SIMPLEX
& DUPLEX**



SAFETY FEATURES
Laser protection flaps





**FIELD TERMINABLE
CONNECTORS**

SC adapters

SC fiber optic adapters are divided into three distinct series: Standard One-Piece, Premium One-Piece and Premium Super One-Piece, which can be characterized by various optical and mechanical parameters. SC fiber optic adapters are constructed in the "one-piece design" technology.

The external housing is one solid body, thus the adapters are more durable than the typical ultrasonic welded type ones. SC fiber optic adapters are available in various options and colours. Optical and mechanical parameters as well as types of adapters are presented in the tables below.

Technical specifications

Parameter	Standard <i>One-Piece</i>	Premium <i>One-Piece</i>	Premium <i>Super One-Piece</i>
Insertion Loss (IL)	max 0.30 dB typ. 0.15 dB	max 0.20 dB typ. 0.10 dB	max 0.20 dB typ. 0.08 dB
Repeatability Δ IL/mating cycle	± 0.10 dB	± 0.08 dB	± 0.08 dB
Durability	500 matings/<0.20 dB typical change	1000 matings/<0.15 dB typical change	1000 matings/<0.15 dB typical change
Strength of coupling mechanism	40N	80N	80N
Operating temperature		-40 up to +85°C	
Alignment sleeve	ceramic	ceramic/metal	ceramic/metal
Mounting	metal wings	metal wings 2D	plastic wings 4D
External shutter	-	☑	-
Internal shutter	-	☑	☑
GR326 TG100 requirements	-	●	☑
Anti-fungus plastic	-	-	☑
Colours			



Types of adapters in each series

Parameter	Standard <i>One-Piece</i>	Premium <i>One-Piece</i>	Premium <i>Super One-Piece</i>
SIMPLEX	☑	☑	☑
DUPLEX	☑	☑	☑
FLANGE	☑	☑	☑
NO FLANGE	☑	☑	☑
METAL MOUNTING CLIP	☑	☑	-
PLASTIC MOUNTING CLIP	-	-	☑
EXTERNAL SHUTTER	-	☑	-
INTERNAL SHUTTER	-	☑	☑

Standard One-Piece Class

The standard series of SC adapter family is available in a simplex and duplex configuration with a metal mounting clip and an optional flange. The main characteristic of FIBRAIN Standard One-Piece adapters is a ceramic sleeve for a singlemode and multimode application. Adapters are available in 5 colours. Adapters can be fitted with a transparent or semi-transparent dust cup.

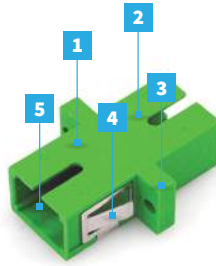

Adapter construction

1. "One-Piece Design" technology
2. Housing available in 5 colours
3. Flange or flangeless configuration
4. Metal mounting clip
5. Ceramic alignment sleeve for SM and MM application

Features

- Innovative technology "One-Piece Design" – increased side loading performance
- Equipped with a metal mounting clip
- Possibility to choose a transparent or semi-transparent dust cover
- High quality and durability
- Wide range of colours - 5 colours available

Premium One-Piece Class

Series of SC fiber optic adapters with improved optical and mechanical performance. The external housing has been reinforced with a metal element, thus adapters exceed the IEC requirements of the strength of coupling mechanism. Adapters are available in a simplex and duplex configuration with an optional flange in 3 colours. The design has proved increased side loading performance over conventional adapters. The Premium One-Piece series can offer adapters with an external or internal shutter.

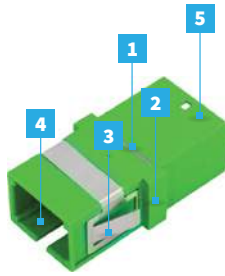

Adapter construction

1. Metal reinforcing element
2. Flange or flangeless configuration
3. Metal mounting clip
4. Optional shutter (outer or inner)
5. One-Piece solid body

Features

- Innovative technology "One-Piece Design" – increased side loading performance over conventional adapters
- Available in a simplex or duplex version, in flange or no flange configuration
- External body is strengthened by metal elements – the adapters exceed the IEC 61300-2-6 requirements for strength of coupling mechanism

Premium Super One-Piece Class

Series of SC adapter family with the highest optical and mechanical parameters. The 'super one-piece design' of housing includes integrated non-metallic panel clips and 4 anti-rattle wings, which significantly reduce movement when snapped into a panel. Adapters are available in a simplex and duplex configuration, in both flange and no flange version.

The Premium Super One-Piece series is constructed from anti-fungus material with the UL94-V0 flammability index.

Adapters are available in 4 colours. There is also version with an inner shutter.

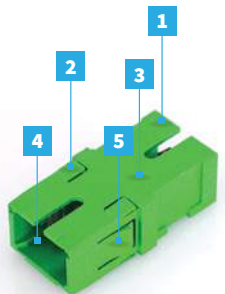

Adapter construction

1. Anti-fungus plastic
2. Special wings for accurate fixation
3. Super One-Piece solid body
4. Optional shutter (inner)
5. Integrated non-metallic panel clip

Features

- Innovative technology "Super One-Piece design" provides more durable construction and increased side loading performance
- 4 anti-rattle wings significantly reduce movement when snapped into a panel
- Built-in panel mounting plate
- Constructed from anti-fungus plastic with the UL94-V0 flammability index
- Typical value of Insertion Loss IL_{TYP} ≤ 0.08 dB

ORDERING SYNTAX

Class	Connector type	No. of fibers	Shutter type	Mounting	Sleeve	Body colour	Dust cover colour
A101 (Standard One-Piece)			N/A		1 (ceramic)	1 (green SM APC) 2 (Blue SM PC) 5 (Beige MM OM1/2) 6 (Aqua MM OM3) 7 (Violet MM OM4)	3 (Black) T (transparent) S (Semi-transparent)
A120 (Premium One-Piece)	SC (PC)	SX (Simplex)	N/A	1 (flange)		1 (green SM APC) 2 (Blue SM PC) 5 (Beige MM OM1/2)	3 (Black)
AS20 (Premium One-Piece with shutters)	SCA (APC)	DX (Duplex)	1 (Internal) 2 (External)	2 (flangeless)	1 (ceramic) 2 (metal)	1 (green SM APC) 2 (Blue SM PC) 5 (Beige MM OM1/2)	
A123 (Premium Super One-Piece)			N/A			1 (green SM APC) 2 (Blue SM PC) 5 (Beige MM OM1/2) 6 (Aqua MM OM3)	
AS23 (Premium Super One-Piece with shutters)			1 (Internal) 2 (External)				

Example

A123-SCA-SX-1113 FIBRAIN SC APC SM adapter, SX, Premium Super One-Piece, with flange, ceramic sleeve, green housing, black dust cover

LC adapters

SC fiber optic adapters are divided into three distinct series: Standard One-Piece, Premium One-Piece and Premium Super One-Piece, which can be characterized by various optical and mechanical parameters. SC fiber optic adapters are constructed in the "one-piece design" technology.

The external housing is one solid body, thus the adapters are more durable than the typical ultrasonic welded type ones. SC fiber optic adapters are available in various options and colours. Optical and mechanical parameters as well as types of adapters are presented in the tables below.

Technical specifications

Parameter	Standard <i>One-Piece</i>	Premium <i>One-Piece</i>	Premium <i>Super One-Piece</i>
Insertion Loss (IL)	max 0.30dB typ. 0.15dB	max 0.20 dB typ. 0.10 dB	max 0.20 dB typ. 0.08 dB
Repeatability ΔIL/mating cycle	± 0.10 dB	± 0.08 dB	± 0.08 dB
Durability	500 matings/<0.20 dB typical change	1000 matings/<0.15 dB typical change	1000 matings/<0.15 dB typical change
Strength of coupling mechanism	40N	80N	80N
Operating temperature		-40 up to +85°C	
Alignment sleeve	ceramic	ceramic/metal	ceramic/metal
Mounting	metal wings	plastic wings 2D	plastic wings 4D
External shutter	-	☑	-
Internal shutter	-	☑	☑
GR326 TG100 requirements	-	●	☑
Anti-fungus plastic	-	-	☑
Colours			

Types of adapters in each series

Parameter	Standard <i>One-Piece</i>	Premium <i>One-Piece</i>	Premium <i>Super One-Piece</i>
DUPLEX	☑	☑	☑
QUAD	☑	☑	-
FLANGE	☑	☑	☑
NO FLANGE	☑	☑	☑
METAL MOUNTING CLIP	☑	-	-
PLASTIC MOUNTING CLIP	-	☑	☑
EXTERNAL SHUTTER	-	☑	-
INTERNAL SHUTTER	-	☑	☑



Standard One-Piece Class

The basic series of LC adapters in a duplex and quad configuration with an optional flange. A ceramic alignment sleeve, which is used in single-mode and multimode adapters, is a characteristic feature of Standard One-Piece series. Adapters are available in 5 colours with metal mounting clips. Adapters are constructed as one solid body, which provides a more durable design over the typical ultrasonic welded type ones.

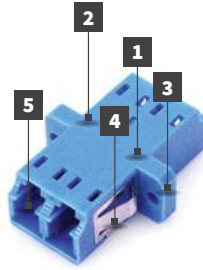

Adapter construction

1. "One-Piece Design" technology
2. Housing available in 5 colours
3. Optional flange
4. Metal mounting clip
5. Ceramic alignment sleeve for SM and MM application



Features

- One-Piece Design
- Flange or flangeless configuration
- High quality and durability
- Colour coding according to the standards

Premium One-Piece Class

Series of LC fiber optic adapters equipped with external or internal shutters, which guarantee protection for the eyes. The adapters are available in a duplex or quad design, with flange or no flange configuration. The Premium One-Piece series has an integrated, non-metallic clips. Therefore, the adapters are available in 3 colours. Characteristic features of the series are excellent optical and mechanical parameters as well as high quality.

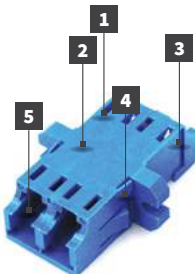

Adapter construction

1. "Super One-Piece Design" technology
2. Anti-fungus material with the UL94-V0 flammability index
3. Housing available in 5 colours
4. Special wings for accurate fixation
5. Optional shutter (inner)



Features

- One-Piece Design,
- Available in a duplex and quad version
- flange or flangeless configuration
- Special wings for accurate fixation
- Internal or external shutter for eye safety
- The highest quality and durability
- Excellent optical and mechanical parameters
- Colour coding according to the standards

Premium Super One-Piece Class

LC Premium Super One-Piece adapters with the highest optical and mechanical parameters. The "super one-piece design" includes integrated non-metallic clips and 4 anti-rattle wings, which significantly reduce movement when snapped into a panel.

Adapters are available in 5 colours in a duplex design, with an optional flange. Therefore, the adapters are constructed from anti-fungus plastic with the UL94-V0 flammability index. The version is available with an inner shutter.

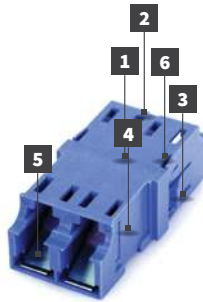

Adapter construction

1. "Super One-Piece Design" technology
2. Anti-fungus plastic with the UL94-V0 flammability index
3. Integrated, non-metal clips
4. Housing available in 5 colours
5. Inner metal shutter
6. Special wings for accurate fixation



Features

- One-piece design
- Special wings for accurate fixation
- flange or flangeless configuration
- Excellent optical and mechanical parameters
- The highest quality and durability
- Constructed from anti-fungus plastic with the UL94-V0 flammability index
- Equipped with an inner metal shutter for eyes protection

ORDERING SYNTAX

Class	Connector type	No. of fibers	Shutter type	Mounting	Sleeve	Body colour	Dust cover colour		
A001 (standard One-Piece)	LC (PC) LCA (APC)	DX (Duplex) 4x (Quad)	N/A	1 (flange) 2 (flangless)	1 (ceramic) 2 (metal)	1 (green SM APC) 2 (Blue SM PC) 5 (Beige MM OM1/2) 6 (Aqua MM OM3) 7 (Violet MM OM4)	3 (Black) T (transparent) S (Semi-transparent)		
AS01 (Premium One-Piece)			N/A			1 (ceramic) 2 (metal)	1 (green SM APC) 2 (Blue SM PC) 5 (Beige MM OM1/2)	3 (Black)	
AS02 (Premium One-Piece with ext. shutters)			1 (Internal) 2 (External)						
A031 (Premium Super One-Piece)			N/A						1 (green SM APC) 2 (Blue SM PC) 5 (Beige MM OM1/2) 6 (Aqua MM OM3)
AS31 (Premium Super One-Piece with shutters)			1 (Internal) 2 (External)						

Example

AS01-LC-DX-11128 FIBRAIN LC PC SM adapter, DX, Premium One-Piece, internal shutter, with flange, ceramic sleeve, blue housing, white dust cover.

E2000™ adapters

Fiber optic adapters are designed to combine E2000™ connectors with a push&pull mechanism, which provides fast and stable connection, and prevents accidental disconnects. The E-2000™ adapter features injection-molded PBT housing, rated to the UL94-V0 flammability index. Spring-loaded laser protection shutters protect against dust and scratching as well as guarantee protection for the eyes.

A high quality ceramic alignment sleeve ensures high performance over 1000 mating cycles. Adapters are equipped with a semi-transparent plastic dust cover, providing optical testing with test lasers without removing the cover. The adapters comply with PN/IEC 61754 and DIN/EN 186270 standards.

Available colours



ELECTRICAL AND MECHANICAL PARAMETERS		
Parameter	E2000™ SM	E2000™ MM
Insertion Loss IL_{MAX}	0.20 dB	0.30 dB
Insertion Loss IL_{TYP}	0.10 dB	0.15 dB
Alignment sleeve	aceramic	ceramic
Durability	1000 matings	
Operating temperature	-40 up to +85°C	
Strength of coupling mechanism	70N	
Inner shutter	☑	☑

Types of E2000™ adapters

Code	Adapter type
R504511	E2000 SM PC, blue housing, flange, ceramic sleeve
R504541	E2000 SM APC, green housing, flange, ceramic sleeve
R504562	E2000 SM APC, green housing, no flange, ceramic sleeve
R508019	E2000 MM PC, black housing, flange, ceramic sleeve



Features

- Equipped with integral self-closing metal laser protection internal shutter, which guarantees protection for the eyes and against dust,
- Excellent optical parameters,
- Mounting with the use of M2 screws or quick mounting by integrated clip (possibility of flangeless adapters),
- Constructed from highly resistant and durable PBT material with UL94-V0 flammability index,
- High quality ceramic alignment sleeve ensures high performance over 1000 mating cycles.

Insertion loss

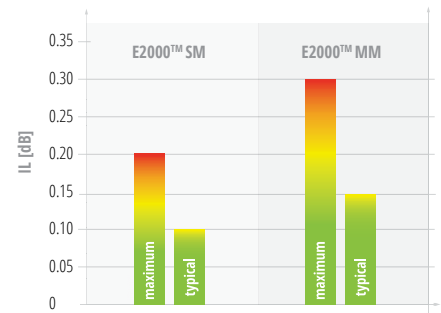

Durability

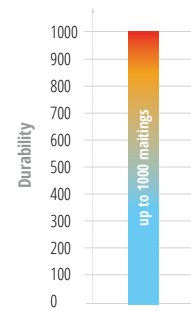

Strength of coupling mechanism

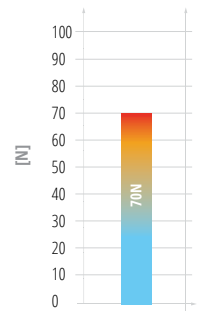

FC&ST adapters

FC adapters

FC connection elements are specifically designed for telecommunication elements, where stable connection is necessary and performed with the use of a thread mechanism. The FC connector is screwed in, which eliminates the possibility of an accidental disconnect.

Therefore, the FC FIBRAIN optic fiber adapters have excellent optical and mechanical parameters as they are constructed from high quality materials. The FC adapters are designed for single- and multimode application with high quality of alignment sleeve.



ORDERING SYNTAX						
Series	Adapter type	Type	Mounting	Sleeve	Housing Colour	Dust cover Colour
A151-Standard	FC	SX	3 d-hole	1 ceramic	0 - metal	1 green
A161-Premium	FCA			2 metal		3 black
						4 red

Example

A151-FCA-SX-3101 FIBRAIN FC APC SM adapter, SX, Standard Series, d-hole mounting, ceramic sleeve, metal housing, green dust cover.

ST adapters

ST FIBRAIN optic adapters are the elements of the fiber optic system, which are used to connect ST connectors using a bayonet mechanism. The ST adapters are characterized by the high quality of the external non-metal housing and alignment sleeve.

Adapters are available for singlemode and multimode applications.

Adapters are precision-made items with excellent optical and mechanical parameters.



ORDERING SYNTAX						
Series	Adapter type	Type	Mounting	Sleeve	Housing Colour	Dust cover Colour
A181-Standard	ST	SX	3 d-hole	1 ceramic	0 - metal	3 black
A191-Premium				2 metal		4 red

Example

A181-ST-SX-3103 FIBRAIN ST PC SM adapter, SX, Standard Series, d-hole mounting, ceramic sleeve, metal housing, black dust cover.

ELECTRICAL AND MECHANICAL PARAMETERS		
Parameter	Standard	Premium
Insertion Loss IL_{MAX}	0.30 dB	0.20 dB
Insertion Loss IL_{TYP}	0.15 dB	0.10 dB
Repeatability ΔIL /mating cycle	± 0.10 dB	± 0.08 dB
Durability	500 matings/ <0.20 dB typical change	1000 matings/ <0.15 dB typical change
Alignment sleeve	ceramic/metal	
Operating temperature	-40 up to +85°C	
Mounting	d-hole	

Features

- Excellent optical and mechanical parameters
- High quality
- Thread or bayonet mount mechanism providing constant and stable connection
- High quality ceramic sleeve for singlemode and phosphor-metal sleeve for multimode applications
- Constructed from material resistant to corrosion

Insertion loss

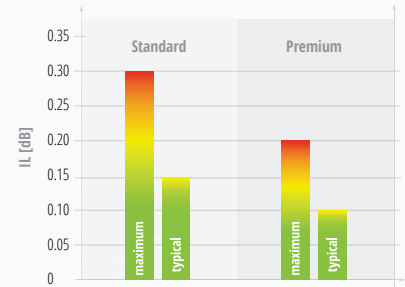

Durability

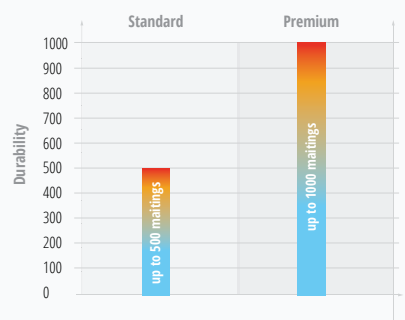

MTP® adapters



Main features

- Adapters provide quick connection of MTP®/ MPO connectors – connection integrity is provided by adapter latches which are locked into place on the connectors by a spring loaded sliding mechanism
- One-piece design of adapter body – increased side loading performance
- Available in black, aqua, beige, violet magenta and green
- Flange or flangeless configuration
- Opposed key orientation - TIA 604-5D (on request aligned key orientation in gray housing Colour)
- Standard MTP footprint type (on request MTP adapters in SC footprint type available)

Applications

- Data Center Systems
- Array trunk cabling
- Dense interconnect for data center and telecommunication system
- Chassis-to-chassis connections
- Structured cabling per TIA-568-C

Available colours



Features

- Low insertion loss
- Meets IEC Standard 61754-7
- Meets TIA/EIA 604-5 Type MPO
- Push-pull mechanism provides quick connections

Ordering information

Code	Adapter type
AD-MTP-SM-GR-F	FIBRAIN MTP SM adapter, flange, green housing, opposed key
AD-MTP-OM1-BG-F	FIBRAIN MTP OM1 adapter, flange, beige housing, opposed key
AD-MTP-OM2-BK-F	FIBRAIN MTP OM2 adapter, flange, black housing, opposed key
AD-MTP-OM3-AQ-F	FIBRAIN MTP OM3 adapter, flange, aqua housing, opposed key
AD-MTP-OM4-V-F	FIBRAIN MTP OM4 adapter, flange, violet housing, opposed key

Field terminable connectors

FIBRAIN Rapid Connectors are specifically designed to terminate optical fibers in installation place. The Rapid Connector is a pre-polished, pre-assembled connector compatible with the standard LC&SC connectors. Total assembly time together with fiber preparation do not exceeds 120 seconds, and requires no extra tools. The ferrules are factory polished, thus no extra polishing materials are necessary. Also the clamp system in the V-grooves, where immersion gel is placed, eliminates the necessity to use other adhesives or epoxy gel and improves the transmission parameters. High quality index matching gel, whose refractive index is close to refractive index of the core of optical fiber, significantly improves Return Loss.

The FIBRAIN Rapid Connector series includes the connectors which can be used to terminate single-mode and multimode optical fibers in 250 μm and 900 μm coating. Moreover, the series is equipped with a special connector construction specifically designed for VC-DCY Drop cables, which are used in FTTH systems. The connectors are mounted on an external cable sheath, not only on a fiber in 250 μm covering, which guarantees higher protection of a connection and eliminate possibility of breaking the fiber.

Excellent transmission parameters, easy assembly in installation place and time saving, are only some benefits of the new series of FIBRAIN Rapid Connector.

ORDERING SYNTAX					
Series	Connector type		Fiber type		Cable type
RC01	1	SC PC	1	SM 9/125 μm	1 250/900 μm
	2	SC APC	2	MM 50/125 μm OM2	2 Drop cable VC-DCY
	3	LC PC	3	MM 62.5/125 μm OM1	
			4	MM 50/125 μm OM3	

Example

RC01-212 FIBRAIN Rapid Connector SC APC for VC-DCY Drop cables.

Additional accessories

RC01- J Assembly Adapter Provides proper stripping length during Rapid Connector's assembly on VC-DCY Drop cables



Available colours

According to fiber type (multimode/single mode –grey&black/ blue&green)



Applications

- LAN networks
- WAN networks
- FTTH networks
- Telecommunication networks
- CATV networks
- Intra-building

Features

- Termination time does not exceed 120 s
- Easy and fast assembly
- Excellent transmission parameters
- High quality materials
- A ferrule polished in a Premium Class has excellent ferrule end face geometry parameters
- A termination is performed with a use of standard equipment
- Durability and resistance of the matching gel for even 25 years
- Exceeds TIA/EIA-568-B.3 standards

TECHNICAL SPECIFICATIONS

Parameter	Connectors		
	SM PC	SM APC	MM PC
Insertion Loss IL _{typ}	0.20 dB	0.30 dB	0.10 dB
Return Loss RL	55 dB	60 dB	35 dB
Durability	< 0.10 dB / 500 matings		
Operating temperature	-40 to +75°C		
Connector type	SC, SCA, LC		

**FIBER
OPTIC**



PRECONNECTORIZED

PRECONNECTORIZED

Perfect Plug&Play solutions for fiber optic networks



RELIABLE SOLUTION



**DIFFERENT
INDOOR/OUTDOOR
CONSTRUCTIONS FOR
DIFFERENT APPLICATIONS**



**PLUG&PLAY SOLUTION FOR
TIME SAVING INSTALLATIONS**

CABLES

CABLES



THE HIGHEST PERFORMANCE
OF FACTORY TERMINATED PLUGS











FULL RANGE
OF THE CONNECTORS
INCLUDING MPO/MTP





100% TESTS
IN QUALITY CONTROL
PROCEDURES

Gold Grade Patch Cords

Patch cord connectors range

		
SC	SCA	LC
		
FC	FCA	E2
		
E2A	DIN	

Ordering syntax

ORDERING SYNTAX									
Series	Connector		Boot type	Length [m]	Cable	Fiber	Cable diameter	Colour	
	A	B							
G-Gold	SC	SC	S-Standard	xxx.x	SX patchcord simplex	A SMF G.652D	16 1.6 mm	OR	
	SCA	SCA	M-Mini		DX patchcord duplex	B SMF G655	18 1.8 mm	Y	
	LC	LC	F-Flex-angled			C SMF G656	28 2.8 mm		
	LCA	LCA				D SMF G657A1			
	FC	FC				E SMF G657A2			
	FCA	FCA				F SMF G657B2			
	E2	E2				G SMF G657B3			
	E2A	E2A				H MMF OM1			
	DIN	DIN				I MMF OM2			
						J MMF OM2+			
					K MMF OM3				
					L MMF OM4				

Example

G-SCA-SCA-S-002.0-SX-A-18-Y FIBRAIN Gold Grade Patchcord, with SC APC connectors at both side, simplex, 2m length, G.652D, 1.8 mm cable diameter, yellow coat

Description

FIBRAIN optical components are specifically designed and based on connectors, which comply with IEC/ PN-EN 61754 and IEC/PN -EN 61755 requirements. Gold grade patch cords are available in singlemode and multi-mode option with various type of connectors, cables and optical fibers. Fully automated preparation and polishing process ensure the highest quality and reliability. Therefore, detailed selection of the manufacturing components ensures the highest quality of the product. Gold grade patch cords are available with 3 different designs of boots, which protect the bend radius of the optical fibers. Apart from standard boots, there are mini and flexi-angle available. The boot in the mini option limits the total length of a connector and boot, whereas the flexi-angle boot is designed to bend in a 0-90° angle range. Available options of the boots are given in the table below. There is no possibility to mix various types of boots on a patchcord- as from the both sides a patchcord is terminated with the same type of boots.

Applications

- Telecommunication networks
- Local area network (LAN)
- FTTx, FTTD, FTTB, FTTH networks
- CATV solutions
- CWDM networks

Features

- Comply with IEC, TIA/EIA requirements
- High quality and repeatability of the transmission parameters
- Connectors are constructed from high quality plastic, resistant to corrosion and high temperatures with UL94-V0 flammability index or the high quality metal resistant to corrosion
- Wide range of available fibers and connectors

TECHNICAL SPECIFICATIONS

Parameter	Connectors		
	SM PC	SM APC	MM PC
Insertion Loss IL _{MAX} against MASTER Acc. IEC 61300-3-4	≤ 0.17 dB	≤ 0.20 dB	≤ 0.20 dB
Insertion Loss IL _{TYP} against MASTER Acc. IEC 61300-3-4	≤ 0.15 dB	≤ 0.16 dB	≤ 0.12 dB
Return Loss Acc. IEC 61300-3-6	≥ 55 dB	≥ 65 dB	≥ 35 dB

Titanium Grade Patch Cords

Patch cord connectors range

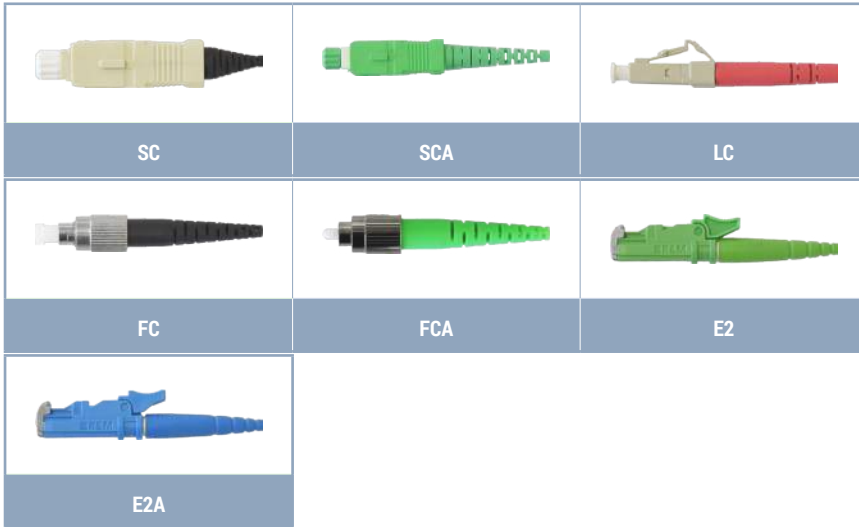

Ordering syntax

ORDERING SYNTAX									
Series	Connector		Boot type	Length [m]	Cable	Fiber	Cable diameter	Colour	
	A	B							
T-Titanium	SC	SC	S-standard	xxx.x	SX patchcord simplex	A SMF G.652D	16 1.6 mm	OR	
	SCA	SCA	M-Mini		DX patchcord duplex	B SMF G655	18 1.8 mm	Y	
	LC	LC	F-Flex-angled			C SMF G656	28 2.8 mm		
	LCA	LCA				D SMF G657A1			
	FC	FC				E SMF G657A2			
	FCA	FCA				F SMF G657B2			
	E2	E2				G SMF G657B3			
	E2A	E2A				H MMF OM1			
						I MMF OM2			
						J MMF OM2+			
						K MMF OM3			
						L MMF OM4			

Example

T-SCA-SCA-S-002.0-SX-D-28-Y FIBRAIN Titanium Grade Patchcord, with SC APC connectors at both side, simplex, 2m length, G.657A1, 2.8 mm cable diameter, yellow coat

Description

FIBRAIN Titanium series of patchcords and pigtails is intended for the most demanding customers. High optical parameters, premium quality and precise selection of the components are the characteristic features of the Titanium Grade. FIBRAIN optical components are specifically designed and based on connectors, which comply with IEC/ PN-EN 61754 and IEC/PN –EN 61755 requirements. Patchcords and pigtails of Titanium Grade are available in singlemode option with various type of connectors, cables and optical fibers. Fully automated preparation and polishing process ensure the highest quality and reliability. Therefore, detailed selection of the manufacturing components ensures the highest quality of the final component.

Applications

- Telecommunication networks
- Local area network (LAN)
- FTTx, FTTD, FTB, FTTH networks
- CATV solutions
- CWDM networks
- Low voltage networks
- Measuring devices

Features









- Comply with IEC, TIA/EIA requirements
- High quality and repeatability of the transmission parameters
- Connectors are constructed from high quality plastic, resistant to corrosion and high temperatures with flammability index UL94-V0 or the high quality metal resistant to corrosion
- High quality ceramic ferrules
- Low attenuation and high reflectance
- Wide range of available connectors and optical fibers

TECHNICAL SPECIFICATIONS



Parameter	Connectors	
	SM PC	SM APC
Insertion Loss IL _{MAX} against MASTER Acc. IEC 61300-3-4	≤ 0.12 dB	≤ 0.20 dB
Insertion Loss IL _{TYP} against MASTER Acc. IEC 61300-3-4	≤ 0.10 dB	≤ 0.16 dB
Return Loss Acc. IEC 61300-3-6	≥ 55 dB	≥ 65 dB

Gold Grade Pigtails

Pigtail connectors range

		
SC	SCA	LC
		
FC	FCA	E2
		
E2A	DIN	

Ordering syntax

ORDERING SYNTAX									
Series	Connector		Boot type	Length [m]	Cable	Fiber	Cable diameter	Colour	
	A	B							
G-Gold	SC	XX	S-Standard	xxx.x	P9 pigtail 900 μm	A SMF G.652D	09 0.9 mm	GR	
	SCA		M-Mini		PS pigtail simplex cable	B SMF G655		GY	
	LC		F-Flex-angled		PD pigtail duplex cable	C SMF G656		BL	
	LCA					D SMF G657A1		BK	
	FC					E SMF G657A2		V	
	FCA					F SMF G657B2		R	
	E2					G SMF G657B3		W	
	E2A					H MMF OM1		AQ	
	DIN					I MMF OM2		BR	
						J MMF OM2+		P	
						K MMF OM3			
						L MMF OM4			

Example

G-SCA-XX-M-001.0-P9-A-09-GR FIBRAIN Gold Grade pigtail, with SC APC connector, Mini boot, 2 m length, G.652D, simplex, 0.9 mm cable diameter, green coat

Description

FIBRAIN optical components are specifically designed and based on connectors, which comply with IEC/ PN-EN 61754 and IEC/PN-EN 61755 requirements. Gold grade patch cords are available in singlemode and multi-mode option with various type of connectors, cables and optical fibers. Fully automated preparation and polishing process ensure the highest quality and reliability. Therefore, detailed selection of the manufacturing components ensures the highest quality of the product. Gold grade patch cords are available with 3 different designs of boots, which protect the bend radius of the optical fibers. Apart from standard boots, there are mini and flexi-angle available. The boot in the mini option limits the total length of a connector and boot, whereas the flexi-angle boot is designed to bend in a 0-90° angle range. Available options of the boots are given in the table below. There is no possibility to mix various types of boots on a patchcord- as from the both sides a patchcord is terminated with the same type of boots.

Applications

- Telecommunication networks
- Local area network (LAN)
- FTTx, FTTD, FTTB, FTTH networks
- CATV solutions
- CWDM networks

Features

- Comply with IEC, TIA/EIA requirements
- High quality and repeatability of the transmission parameters
- Connectors are constructed from high quality plastic, resistant to corrosion and high temperatures with UL94-V0 flammability index or the high quality metal resistant to corrosion
- Wide range of available fibers and connectors

TECHNICAL SPECIFICATIONS

Parameter	Connectors		
	SM PC	SM APC	MM PC
Insertion Loss IL _{MAX} against MASTER Acc. IEC 61300-3-4	≤ 0.17 dB	≤ 0.20 dB	≤ 0.20 dB
Insertion Loss IL _{TYP} against MASTER Acc. IEC 61300-3-4	≤ 0.15 dB	≤ 0.16 dB	≤ 0.12 dB
Return Loss Acc. IEC 61300-3-6	≥ 55 dB	≥ 65 dB	≥ 35 dB

Titanium Grade Pigtails

Patch cord connectors range

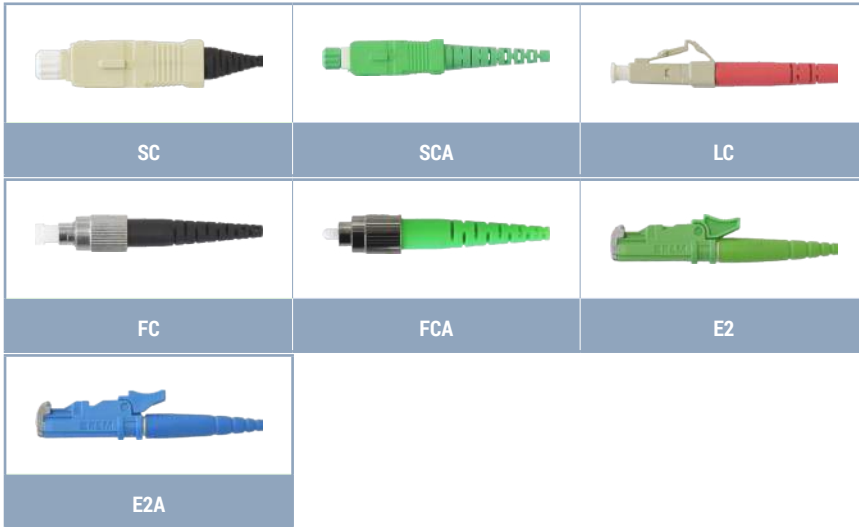

Ordering syntax

ORDERING SYNTAX									
Series	Connector		Boot type	Length [m]	Cable	Fiber	Cable diameter	Colour	
	A	B							
T-Titanium	SC	XX	S-standard	xxx.x	P9 pigtail 900 µm	A SMF G.652D	09 0.9 mm	GR	
	SCA		M-Mini		PS pigtail simplex cable	B SMF G655		GY	
	LC		F-Flex-angled		PD pigtail duplex cable	C SMF G656		BL	
	LCA					D SMF G657A1		BK	
	FC					E SMF G657A2		V	
	FCA					F SMF G657B2		R	
	E2					G SMF G657B3		W	
	E2A					H MMF OM1		AQ	
						I MMF OM2		BR	
						J MMF OM2+		P	
						K MMF OM3			
						L MMF OM4			

Example

T-SCA-SCA-S-001.0-M-A-09-GR FIBRAIN Titanium Grade Pigtail, with SC APC connector, Mini boot, 2 m length, G.652D, 0.9 mm cable diameter, green coat

Description

FIBRAIN optical components are specifically designed and based on connectors, which comply with IEC/ PN-EN 61754 and IEC/PN -EN 61755 requirements. Gold grade patch cords are available in singlemode and multi-mode option with various type of connectors, cables and optical fibers. Fully automated preparation and polishing process ensure the highest quality and reliability. Therefore, detailed selection of the manufacturing components ensures the highest quality of the product. Gold grade patch cords are available with 3 different designs of boots, which protect the bend radius of the optical fibers. Apart from standard boots, there are mini and flexi-angle available.

Applications

- Telecommunication networks
- Local area network (LAN)
- FTx, FTTD, FTB, FTH networks
- CATV solutions
- CWDM networks
- Low voltage networks
- Measuring devices

Features

- Comply with IEC, TIA/EIA requirements
- High quality and repeatability of the transmission parameters
- Connectors are constructed from high quality plastic, resistant to corrosion and high temperatures with flammability index UL94-V0 or the high quality metal resistant to corrosion
- High quality ceramic ferrules
- Low attenuation and high reflectance
- Wide range of available connectors and optical fibers

TECHNICAL SPECIFICATIONS

Parameter	Connectors	
	SM PC	SM APC
Insertion Loss IL_{MAX} against MASTER Acc. IEC 61300-3-4	≤ 0.12 dB	≤ 0.20 dB
Insertion Loss IL_{TYP} against MASTER Acc. IEC 61300-3-4	≤ 0.10 dB	≤ 0.16 dB
Return Loss Acc. IEC 61300-3-6	≥ 55 dB	≥ 65 dB

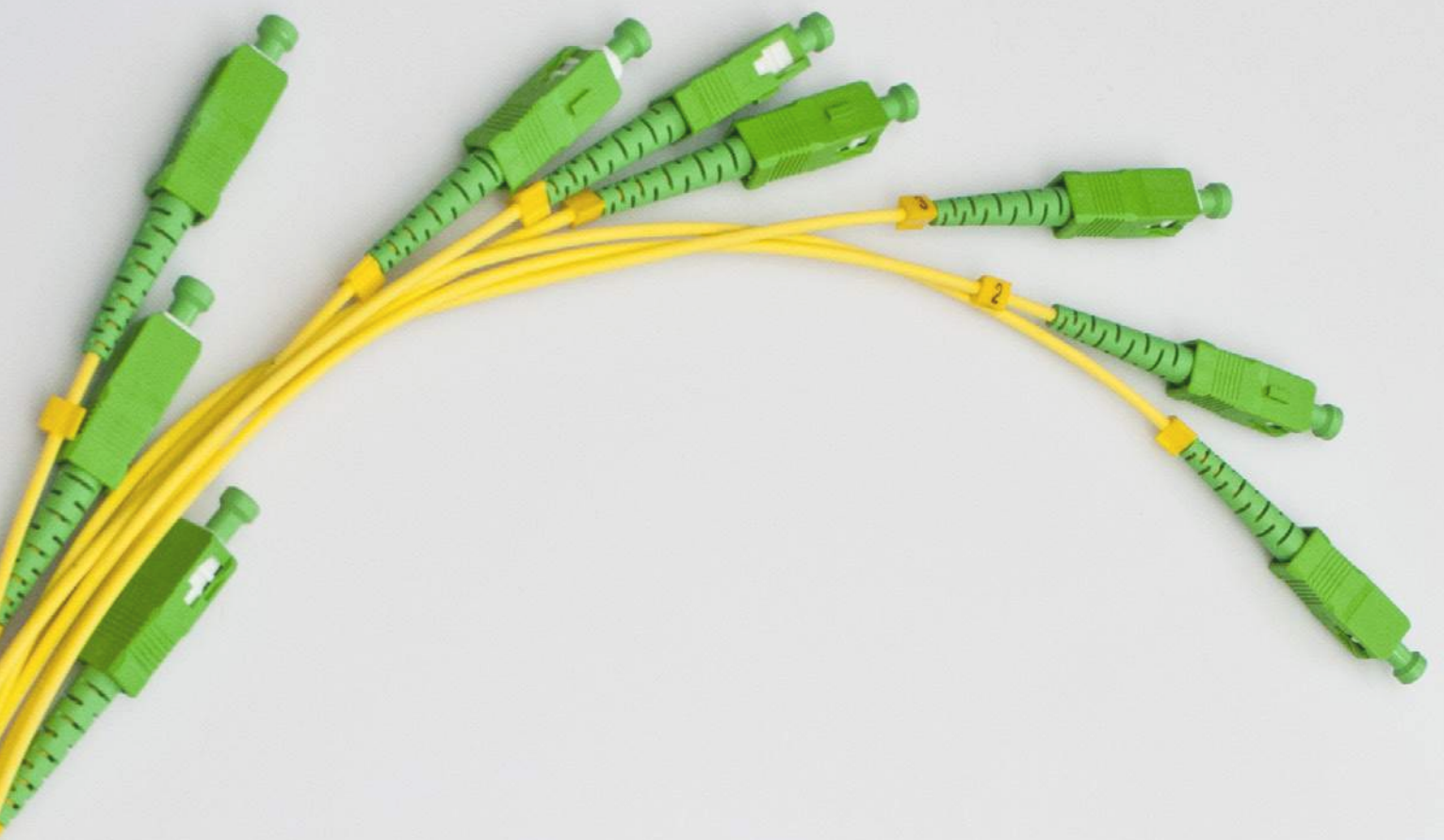

Pigtail set

PIGTAIL SET



Pigtail Set with a standard 900 µm colorful protection tube

Available colours of tubes

red	green	blue	yellow	white	grey	brown	violet	orange	black	pink	aqua

ORDERING SYNTAX

Series	Connector		Boot type	Length [m]	Cable	Fiber	Cable diameter	Colour		
	A	B								
G-SET12	SC	XX	S-Standard	xxx.x	P9 pigtail 900 µm	A SMF G.652D	09 0.9 mm	12 multi-color		
	SCA								Y	
	LC									
	LCA									L MMF OM4
	FC									
	FCA									
	E2									
	E2A									
	ST									

Example

G-SET12-SCA-XX-S-002.0-P9-A-09-12 FIBRAIN Pigtail Gold, SET 12 pieces, SC APC connector, G.652D, 2m length, 0.9 mm tube in 12 colors

Patch Cords & Pigtails

Description

→ The set of 12 fiber optic pigtails polished in the Gold grade. This set is available in two versions: 12 pigtails in yellow protection tube 0.9 mm or a set of 12 pigtails with multicolor 0.9 mm protection tubes. The set of pigtails facilitates the assembly and identification of fiber optic splices, which saves installation time and lower the costs substantially. The tubes are available in the following colors: red, green, blue, yellow, white, grey, brown, purple, orange, black, pink, aqua.

Applications

- Telecommunication networks
- Local area network (LAN)
- FTx, FTTD, FTB, FTTH networks
- CATV solutions
- CWDM networks
- Low voltage networks
- Measuring devices

Features

- Comply with IEC, TIA/EIA requirements,
- High quality and repeatability of the transmission parameters,
- Connectors are constructed from high quality plastic, resistant to corrosion and high temperatures with flammability index UL94-V0 or the high quality metal resistant to corrosion,
- High quality ceramic ferrules,
- Low attenuation and high reflectance,
- Wide range of available connectors and optical fibers.

TECHNICAL SPECIFICATIONS

Parameter	Connectors		
	SM PC	SM APC	MM PC
Insertion Loss IL _{MAX} against MASTER Acc. IEC 61300-3-4	≤ 0.35 dB	≤ 0.35 dB	≤ 0.35 dB
Insertion Loss IL _{TP} against MASTER Acc. IEC 61300-3-4	≤ 0.28 dB	≤ 0.28 dB	≤ 0.25 dB
Return Loss Acc. IEC 61300-3-6	≥ 50 dB	≥ 60 dB	≥ 90 dB

TCF Easylink 1 multipatchcords



Mechanical and environmental characteristics

Parameter	Standard	
Max. tensile load	IEC 61753-2-1	80N-fanout 1.8 mm/2.8 mm 7N- 900 µm tube
Crush performance	EN 187101, IEC 60794-1-2-E3, no attenuation increase	100N
Installation temperature range	EN 187101, IEC 60794-1-2-F1, no attenuation increase	-10... +50 [°C]
Operation*	EN 187101, IEC 60794-1-2-F1, no attenuation increase	-30... +70 [°C]
Transport & Storage		-30... +70 [°C]
Max. Insertion Loss (per connector)	IEC 61300-3-4	≤ 0.3dB
Return Loss (RL)	IEC 61300-3-6	RL≥65 dB(APC); RL≥50 dB(SM UPC); RL≥30 dB(MM PC)

*Temperature range varies from the cable type.

Technical specification

Parameter					
Max. outer diameter of cable divider [mm]	Ø 15	Ø 18	Ø 22*	Ø 24*	Ø 27*
Length of cable divider [mm]	55	65	65	70	80
Number of fibers in 0.9mm tubes	4-48	49-96**			
Number of fibers in 1.8 mm fanouts	4-16	17-32	33-48	49-60	61-96**
Number of fibers in 2.8mm fanouts	4-10	11-18	19-26	27-32	33-48**
Connector type	SC/SCA/E2/E2A/LC/LCA/FC/FCA/ST				

*Ø 22 - Ø 27 adapted to 1.8 - 2.8mm fanouts

** There is a possibility of performing pre-connectorized cables with more fibers after consulting with our sales department.

Description

→ Easylink 1 pre-connectorized multi-fiber cables are specifically designed to serve as general-purpose products. The solution provides termination of loose tube cables as well as other cable types. The fibers are inserted into 0.9mm tube or fanouts, strengthened by Kevlar fibers, with 1.8 mm or 2.8 mm (depending on a cable type). Therefore, the furcation point is protected by a heatshrink sleeve. Then, fibers are terminated with connectors in accordance with customer's needs and requirements.

→ In addition, from an economic point of view TCF cables provide cost-effective solutions, thus are popular in the structured cabling systems, where they are used as links between distribution points. It is a Plug and Play solution, which facilitates fast and easy installation, with no extra equipment, as in traditional installation with splices.

Features

- Furcation point is protected by plastic tube and a heatshrink sleeve
- High quality
- Easy and fast installation
- Plug & Play solution
- Common in structured cable systems
- Wide range of fiber optic connectors

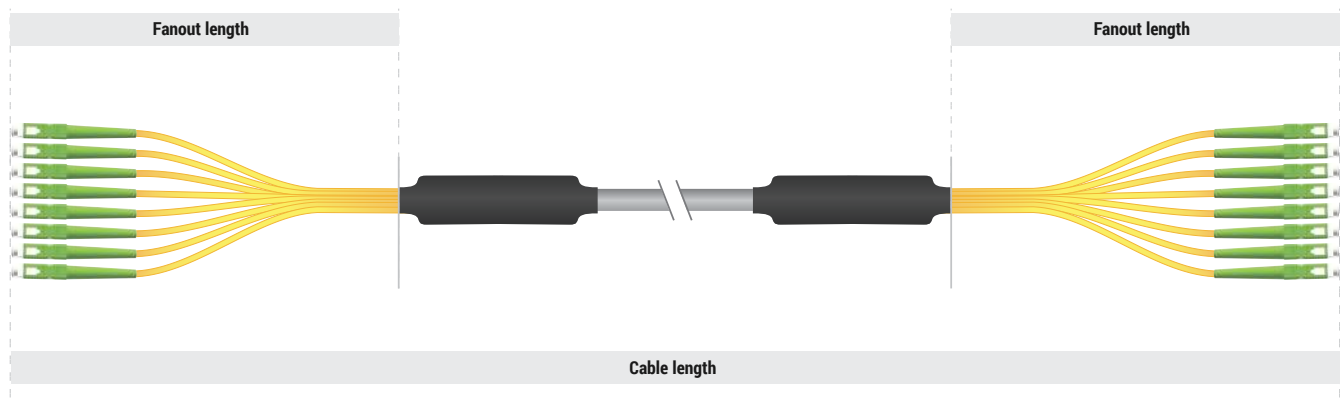

TCF Easylink 1 multipatchcords

Ordering syntax

TCF-**AABBB**-**CCDDD**-**EEF**-**XXXX.X**-**GYYYY**-**ZZZJ**

AA – Connectors qty (Side A)	4-96		
BBB – Type of connector (Side A)	SC-SC/PC		
	SCA		
	E2		
	E2A		
	LC		
	LCA		
	FC		
	FCA		
	ST		
Connectors qty (Side B)	4-96		
BBB – Type of connector (Side B)	SC-SC/PC		
	SCA		
	E2		
	E2A		
	LC		
	LCA		
	FC		
	FCA		
	ST		
EE – Cable type	01	EXO-CO PE	
	02	EXO-CO LSZH	
	03	EXO-CI PE	
	04	EXO-CI LSZH	
	05	BDC-CO PE	
	06	BDC-CO LSZH	
	07	BDC-CI PE	
	08	BDC-CI LSZH	
	24	BURRY DAC	
	28	AERO DF 03	
	35	FTTA DAC	
	F – Fibre type	A	SMF G.652D
		B	SMF G655
		C	SMF G656
		D	SMF G657A1
E		SMF G657A2	
F		SMF G657B2	
G		SMF G657B3	
H		MMF OM1	
I		MMF OM2	
J		MMF OM2+	
K	MMF OM3		
L	MMF OM4		

XXXX.X Cable length	XXXX.X	
G – Stepping (Side A)	0 –	equal length
	1 –	single cascade
	2 –	double cascade
YYY – Fan-out length (Side A) [cm]	yyy	
H – Fan-out diameter (Side A)	0 –	0.9 mm
	1 –	1.8 mm
	2 –	2.8 mm
I – Stepping (Side B)	0 –	equal length
	1 –	single cascade
	2 –	double cascade
ZZZ – Fan-out length (Side B) [cm]	zzz	
J – Fan-out diameter (Side B)	0 –	0.9 mm
	1 –	1.8 mm
	2 –	2.8 mm

Maximal outputs length in a standard configuration: 200 cm, minimal: 10 cm; for other outputs length please contact with our sales department.

AVAILABLE CASCADES	
Singe cascade	Each furcation leg is shorter by 3 cm than a previous one
Double cascade	Pair of furcation legs is shorter by 3 cm than a previous one

Example

TCF-**12SCA**-**12SCA**-**01A**-**0100.0**-**01201**-**11200**

PTF pre-connectorized cable (EXO CO PE), SM G.652D fibers, 100 m total length, pre-connectorized with 12xSC/APC connectors on both sides, Side A : equal length of all fan-out cables, fan-out length 120cm, diameter of each fan-out cable 1.8 mm, Side B: single cascade of fan-out, fan-out length 120 cm (of the longest cable), diameter of each fan-out cable 0.9 mm.

To order a non-standard option, please contact with our Sales Department.

PTF Easylink 2 multipatchcords



Mechanical and environmental characteristics

Parameter	Standard	
Max. tensile load	IEC 61753-2-1	100N
Crush performance	EN 187101, IEC 60794-1-2-E3, no attenuation increase	1000N
Installation temperature range	EN 187101, IEC 60794-1-2-F1, no attenuation increase	-10... +50 [°C]
Operation*	EN 187101, IEC 60794-1-2-F1, no attenuation increase	-30... +70 [°C]
Transport & Storage		-30... +70 [°C]
Max. Insertion Loss (per connector)	IEC 61300-3-4	≤ 0.3dB
Return Loss (RL)	IEC 61300-3-6	RL≥65 dB(APC); RL≥50 dB(SM UPC); RL≥30 dB(MM PC)

*Temperature range varies from the cable type.

Technical specification

Parameter		
Max. outer diameter of furcation point [mm]	Ø 18	Ø 21
Length of furcation point	90	100
Number of fibers in fanouts	1-12	1-24
Connector type	SC/SOA/E2/E2A/LC/LCA/FC/FCA/ST	

*Ø 22 - Ø 27 adapted to 1.8 - 2.8mm fanouts

** There is a possibility of performing pre-connectorized cables with more fibers after consulting with our sales department.

Description

- Easylink 2 pre-connectorized multi-fiber cables are specifically designed to serve as general-purpose products. The solution provides termination of loose tube cables as well as other cable types. The fibers are inserted into 0.9mm tube or furcation, strengthened by Kevlar fibers, with 1.6mm or 2.8mm (depending on a cable type). Therefore, the furcation point is protected by a metal sleeve with a boot protecting from moving and bending. Then, fibers are terminated with connectors in accordance with customer's needs and requirements. Moreover, output legs are placed inside a reusable protection tube, which is fixed to a bushing and may be used as a pulling grip.
- In addition, from an economic point of view PTF-Easylink2 cables provide cost-effective solutions, thus they are popular in the structured cabling systems, where they are used as links between distribution points. It is a Plug and Play solution, which facilitates fast and easy installation, with no extra equipment, as in traditional installation with splices.

Features

- Furcation point is protected by plastic tube and a heatshrink sleeve,
- High quality,
- Easy and fast installation,
- Plug & Play solution,
- Common in structured cable systems,
- Wide range of fiber optic connectors.

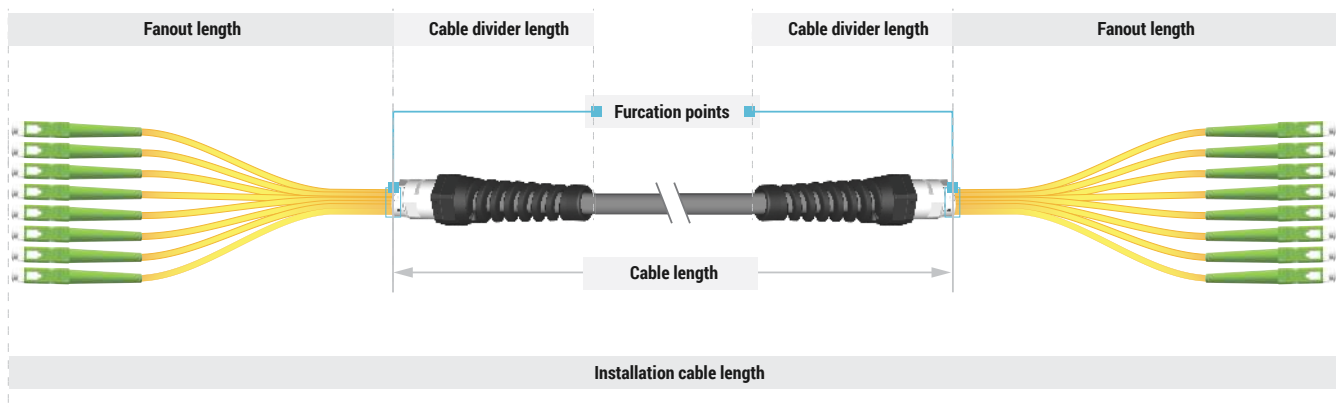

PTF Easylink 2 multipatchcords

Ordering syntax

PTF-**A**A**B**B**B**-**C**C**D**D**D**-**E**E**F**-**X**X**X**X**.X**-**G**Y**Y**Y**H**-**I**Z**Z**Z**J**

AA – Connectors qty (Side A)	4-96		
BBB – Type of connector (Side A)	SC-SC/PC		
	SCA		
	E2		
	E2A		
	LC		
	LCA		
	FC		
	FCA		
	ST		
Connectors qty (Side B)	4-96		
BBB – Type of connector (Side B)	SC-SC/PC		
	SCA		
	E2		
	E2A		
	LC		
	LCA		
	FC		
	FCA		
	ST		
EE – Cable type	01	EXO-CO PE	
	02	EXO-CO LSZH	
	03	EXO-CI PE	
	04	EXO-CI LSZH	
	05	BDC-CO PE	
	06	BDC-CO LSZH	
	07	BDC-CI PE	
	08	BDC-CI LSZH	
	24	BURRY DAC	
	28	AERO DF 03	
	35	FTTA DAC	
	F – Fibre type	A	SMF G.652D
		B	SMF G655
		C	SMF G656
		D	SMF G657A1
E		SMF G657A2	
F		SMF G657B2	
G		SMF G657B3	
H		MMF OM1	
I	MMF OM2		
J	MMF OM2+		
K	MMF OM3		
L	MMF OM4		

XXXX.X Cable length	XXXX.X	
G – Stepping (Side A)	0 –	equal length
	1 –	single cascade
	2 –	double cascade
YYY – Fan-out length (Side A) [cm]	yyy	
H – Fan-out diameter (Side A)	0 –	0.9 mm
	1 –	1.8 mm
	2 –	2.8 mm
I – Stepping (Side B)	0 –	equal length
	1 –	single cascade
	2 –	double cascade
ZZZ – Fan-out length (Side B) [cm]	zzz	
J – Fan-out diameter (Side B)	0 –	0.9 mm
	1 –	1.8 mm
	2 –	2.8 mm

Maximal outputs length in a standard configuration: 200 cm, minimal: 10 cm; for other outputs length please contact with our sales department.

AVAILABLE CASCADES	
Singe cascade	Each furcation leg is shorter by 3 cm than a previous one
Double cascade	Pair of furcation legs is shorter by 3 cm than a previous one

Example

PTF-**12**S**C**A-**12**S**C**A-**01**A-**0100.0**-**01201**-**11200**

PTF pre-connectorized cable (EXO CO PE), SM G.652D fibers, 100 m total length, pre-connectorized with 12xSC/APC connectors on both sides, Side A : equal length of all fan-out cables, fan-out length 120cm, diameter of each fan-out cable 1.8 mm, Side B: single cascade of fan-out, fan-out length 120 cm (of the longest cable), diameter of each fan-out cable 0.9 mm.

To order a non-standard option, please contact with our Sales Department.

MTP® trunk/connecting cables

Fiber identification and polarization classification:

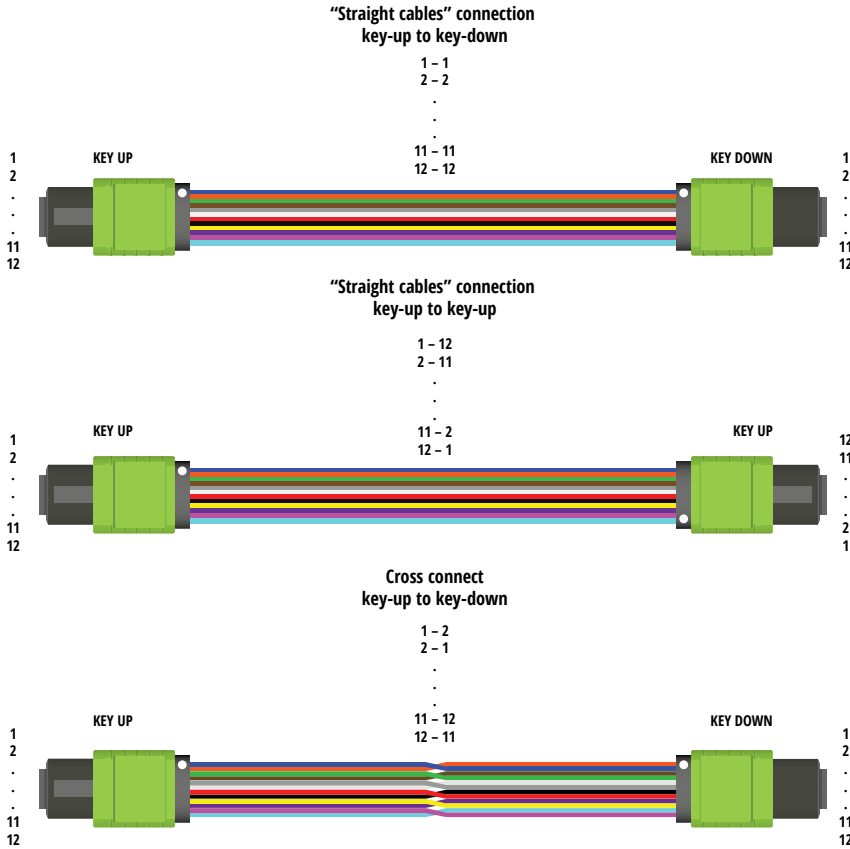

Ordering information

Class	Fiber qty	Connector		Boot type	Cable diameter	Length [m]	Cable type	Fiber type	Polarization
		A	B						
G-Gold	12-12	MTPA.F – MTP female APC	MTPA.F – MTP female APC	S - standard	R30 – round 3.0 mm	001.0	1 – DC PRIM	A – G652D	A
		MTPA.M – MTP male APC	MTPA.M – MTP male APC					D – G657A1	B
		MTP.F – MTP female	MTP.F – MTP female					E – G657A2	C
		MTP.M – MTP male	MTP.M – MTP male					H – OM1	
								I – OM2	
								K – OM3	
				L – OM4					

Description

→ Fiber optic patchcords terminated with MTP® connectors are specifically designed for Data Center system. MTP® connectors, using the MT ferrule, can increase the density of 4 to 72x compared to traditional, single-fiber optic connectors. MTP® patchcords and pigtails are specifically designed to be used in both single- and multimode transmission. Modern and repeatable production process, detailed quality control, interferometric as well as IL & RL parameters control measurement make FIBRAIN patchcords and pigtails reliable elements of tracks and fiber optic networks. Connecting elements terminated with MTP® connectors are popular and willingly used solution for Data Center cabling, backbone networks and local broadcast of bandwidth 40/100 Gb /s bandwidth.

Applications

- Telecommunication networks,
- Data Center SYSTEMS,
- FTtx, FTTD, FTTB, FTTH networks

Features

- In accordance with IEC 61754-7, TIA/EIA 568-C,
- High quality and repeatability of transmission parameters,
- Connectors made of high quality plastics,
- MTP connectors compatible with MPO connectors,
- Good value for money, the best price-quality,
- High quality MT ferrule provides placing a lot of optical fibers in one connector.

TECHNICAL SPECIFICATIONS

Parameter	MTP APC SM	MM PC
Insertion Loss IL _{MAX} against MASTER Acc. IEC 61300-3-4	≤ 0.40 dB	≤ 0.40 dB
Insertion Loss IL _{TYP} against MASTER Acc. IEC 61300-3-4	≤ 0.20 dB	≤ 0.20 dB
Return Loss Acc. IEC 61300-3-6	≥ 65 dB	≥ 35 dB

MTP® fanouts direct split



Description

→ FIBRAIN MTP® Fanouts of Direct Split type connect MTP® multi-fiber connectors with standard, single-fiber optic connectors. This solution is specifically designed to be used in singlemode and multimode transmission. Therefore, in our product portfolio, there is a wide range of fiber optic connectors. The side terminated with MTP® connectors includes male or female connectors- depending on customer's needs.

Applications

- Telecommunication networks,
- Data Center SYSTEMS,
- FTTx, FTTD, FTTB, FTTH networks

Features

- In accordance with IEC, TIA/EIA standards ,
- High quality and repeatability of transmission parameters,
- Connectors made of high quality plastics,
- Good value for money, the best price-quality ratio,
- High quality MT ferrule, provides placing a lot optical fibers in one connector.

Technical specification

Multi-fiber MTP connectors

Parameter	MTP APC SM	MM PC
Max. Insertion Loss $I_{L_{MAX}}$ Acc. IEC 61300-3-4	≤ 0.40 dB	≤ 0.40 dB
Typical Insertion Loss $I_{L_{TYP}}$ Acc. IEC 61300-3-4	≤ 0.20 dB	≤ 0.20 dB
Return Loss RL Acc. IEC 61300-3-6	≥ 65 dB	≥ 35 dB

Single-fiber standard optical connectors

Parameter (connectors)	SM PC	SM APC	MM
Max. Insertion Loss $I_{L_{MAX}}$ Acc. IEC 61300-3-4	≤ 0.17 dB	≤ 0.20 dB	≤ 0.20 dB
Typical Insertion Loss $I_{L_{TYP}}$ Acc. IEC 61300-3-4	≤ 0.15 dB	≤ 0.16 dB	≤ 0.12 dB
Return Loss RL Acc. IEC 61300-3-6	≥ 55 dB	≥ 65 dB	≥ 35 dB

Fiber identification - fiber color (outer transparent tube)

1-12	1	2	3	4	5	6	7	8	9	10	11	12
Code												
Color	blue	orange	green	brown	grey	white	red	black	yellow	violet	pink	aqua

Ordering information

Class	Fiber qty	Connector		Boot type	Cable diameter	Length [m]	Cable type	Fiber
		A	B					
G-Gold	12-12	MTPA.F – MTP female APC	SC	S -standard	09 - 900µm	001.0	DS – Direct Split	A – G652D
		MTPA.M – MTP male APC	SCA					D – G657A1
		MTP.F – MTP female	LC					E – G657A2
		MTP.M – MTP male	LCA					H – OM1
			FC					I – OM2
			FCA					K – OM3
			E2					L – OM4
			E2A					

**FIBER
OPTIC**



PATCH PANELS

FIBER OPTIC PATCH PANELS

Platform for fiber optic and copper solutions



**SOLID & RELIABLE
CONSTRUCTION**



**HIGHEST DENSITY
UP TO 96 FIBERS PER 1U**



1U-3U VERSIONS

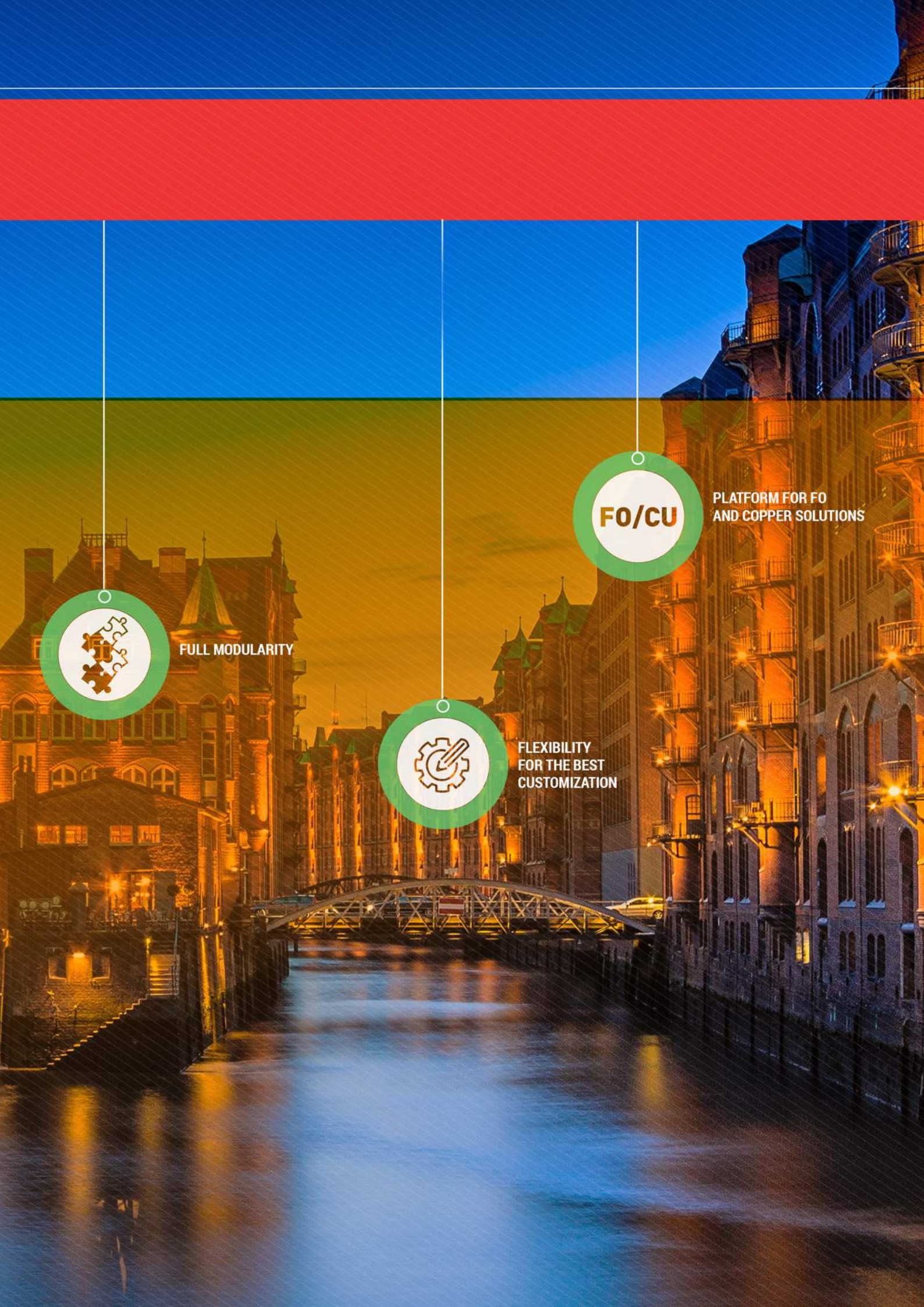

FULL MODULARITY



FLEXIBILITY
FOR THE BEST
CUSTOMIZATION



PLATFORM FOR FO
AND COPPER SOLUTIONS

PST-A1 Equipped Patch Panel



TECHNICAL SPECIFICATIONS

	PST-A1-01	PST-A1-02
Height	1U (44 mm)	2U (88 mm)
Width	19" (483 mm)	19" (483 mm)
Depth [mm]	258	258
Max. cassette capacity	3	6
Casing material	Powder painted steel	Powder painted steel

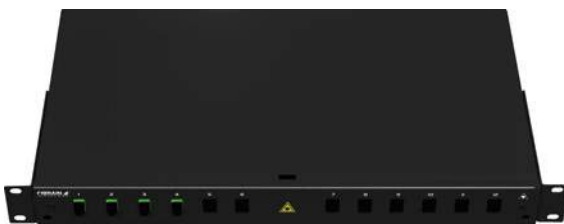
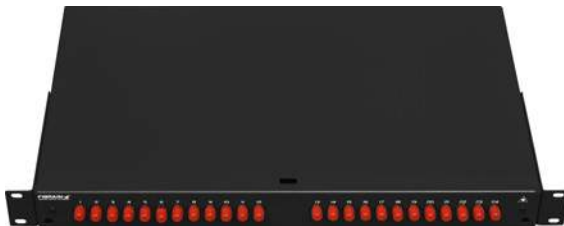

Description

→ FIBRAIN telescopic fiber optic patch panel PST-A1 are specifically designed and tailored to meet our customers' needs. Main distribution areas where these panels can be applied are patching shelves and splicing shelves. Removable front panels facilitate installation of all standards of adapters, including hybrid combinations. Patch panels are made of grey RAL7035 powder-coated metal steel and are available in 1U and 2U options. Telescopic patch panels are available in black RAL7005 too. Panels on telescopic rails provide a full opening to mount cables easily. Cable entries are adjusted to mount PG13.5 - PG16 cable glands and preterminated multifiber cables (FIBRAIN multipatchcords solution). The interior design with handles facilitate proper management of fibers. Therefore, adjustable side handles provide the possibility to move the panel inside the cabinets. Our product portfolio offer includes a large variety of front plates, thus almost each standard of adapters can be easily mounted.

Applications

- Fiber optics interchange points
- Distribution networks
- Server room

Features

- Available in 1U and 2U
- Full opening on telescopic rails
- Cable entries in a back part of a panel
- Internal perforation to manage tubes or fibers
- Faceplates for mounting adapters without screws
- Optional front shelf to facilitate the management of patchcords
- Adjustable side handles
- Front plates can be optionally locked with a key
- High capacity
- Holder for the strength element of cable

PST-A1 Equipped Patch Panel

Ordering syntax

PST-A1-**AABBC**-**DDEFG**-**HHIJJKLL**-**MN**-**OOOP**-**RS**

AA – Height	01 – 1U	grey RAL7035	
	02 – 2U	grey RAL7035	
	B1 – 1U	black RAL 9005	
	B2 – 2U	black RAL 9005	
BB – Front plate type	01 – FB2030	12x ST,FC	Pannels 1U
	02 – FB2031	12x SC SX, LC DX, E2000 SX	
	03 – FB2031B	12x SC SX, LC DX, E2000 SX, black	
	04 – FB2032	12x SC DX, LC 4X	
	05 – FB2032B	12x SC DX, LC 4X, black	
	06 – FB2033	24x ST, FC	
	07 – FB2034	24x SC SX,LC DX, E2000 SX	
	08 – FB2034B	24x SC SX,LC DX, E2000 SX, black	
	09 – FB2035	24x SC DX, LC 4X	Pannels 2U
	10 – FB2035B	24x SC DX, LC 4X, black	
	11 – FB2043	48x ST, FC	
	12 – FB2044	48x SC SX, LC DX, E2000 SX	
	13 – FB2045	48x SC DX, LC 4X	
	14 – FB2046	72x SC SX, LC DX, E2000 SX	
	15 – FB2046B	72x SC SX, LC DX, E2000 SX, black	
	16 – FB2047	72x ST, FC	
C – Lock	K –	plate with lock	
	0 –	plate without lock	

DD – Adapters qty	6,12,24,36,48,72
E – Adapter class	0 – none
	1 – Standard One-Piece (or standard E2000, FC, ST)
	2 – Premium Super One-Piece
	3 – Premium One-Piece with internal shutter
	4 – Premium Super One-Piece with internal shutter
5 – Premium (@FC, ST)	
F – Adapter type	0 – none
	1 – SC
	2 – SCA
	3 – E2000
	4 – E2000 APC
	5 – LC
	6 – LCA
	7 – FC
	8 – FCA
9 – ST	
G – Transmission	1 – SM
	2 – MM (beige @SC/LC, black @E2000)
	3 – MM OM3 (aqua @SC/LC)
	4 – MM OM4 (violet @SC/LC)

HH – Pigtaills qty	6,12,24,36,48,72,96
I – Fiber type	A – G.652D
	B – G.655
	C – G.656
	D – G.657A1
	E – G.657A2
	F – G.657B2
	G – G.657B3
	H – MM OM1
	I – MM OM2
	K – MM OM3
	L – MM OM4
JJ – Connector type	01 – SC
	02 – SCA
	03 – LC
	04 – LCA
	05 – FC
	06 – FCA
	07 – E2
	08 – E2A
	09 – ST
	S – Silver
K – Pigtail grade	G – Gold
	T – Titanium
	LL – Color identification
01 –	for pigtaills with yellow 0.9 mm buffer
02 –	for pigtaills with orange 0.9 mm buffer
03 –	T TELECOM (acc. to IEC60304)
04 –	T1 TELECOM (acc. to 60304/tab. 3 & ZN-11/TPSA-005-02)
05 –	T2 TELECOM (acc. to EIA 598A)
06 –	D DATACOM (acc. to DIN VDE 0888 & IEC 60304)
07 –	D1 DATACOM (acc. to IEC 60304, TIA/EIA 598-A, TIA/EIA 598-C)

M – Splice trays number	1-6
N – Splice trays type	1 – SCM-A-12H
	2 – SCM-A-24H

OOO – Sleeve qty	6,12,24,36,48,72
P – Sleeve type	1 – 45 mm

R – Cable gland qty	1-4
S – Cable gland type	1 – PG13.5
	2 – PG16

Example

PST-A1-**01020**-**12121**-**12D02G01**-**11**-**0121**-**11** FIBRAIN telescopic fiber optic patch panel, 1U, equipped with front plate FB2031 (12x SC SX), Standard SM One-Piece SC APC adapters, 12 SM pigtaills Gold Grade SC APC, 2 m long, yellow jacket, one 12F splice tray with 12F splice magazine, front plate without the lock mechanism, equipped with PG13,5 cable gland, grey color of body

To order a non-standard option, please contact with our Sales Department.

PST-C1 Telescopic Fiber Optic Patch Panel



TECHNICAL SPECIFICATIONS

Height	1U (44 mm)
Width	19" (483 mm)
Depth [mm]	256
Max. cassette capacity	2
Casing material	Powder painted steel
Front flap	Anodized aluminium



Description

- FIBRAIN telescopic patch panel offers excellent flexibility during mounting and installation. Mainly used for distribution – patching or splicing shelves. Constructed of high quality material ensuring very easy installation and maintenance.
- Removable front panels facilitates installation of all kinds of adapters, including the creation of hybrid combinations.
- Patch panels are made of powder-coated steel as standard in black and available in 1U option. The movable front flap is made of anodized aluminum which protects pigtailed against accidental damage. Panels mounted on telescopic rails provide a full extension for easy cable mounting. Cable entry adjusted to mount PG16 cable glands and terminated FIBRAIN multipatchcords solution. The interior design with handles with handles facilitate the proper management of fiber. Therefore, adjustable side handles provide the possibility to move the panel inside the cabinets.

Applications

- Fiber optics interchange points
- Distribution networks
- Server room

Features

- 1U
- Full extension on telescopic rails
- Cable entry shifted back in a patch panel
- Handles to manage tubes or fibers
- Removable faceplates for mounting adapters without screws
- Front shelf for patchcords management
- Adjustable side handles
- High capacity
- Moveable front flap, which is a patch cord protection from accidental damage

PST-C1 Telescopic Fiber Optic Patch Panel

Ordering syntax

PST-C1-AA-BCC-DDEFG-HHIJJKK-LM-NNO-PR

AA – Height	01 – 1U
B – Panels qty	1 – 1x12 ports front panel
	2 – 2x12 ports front panel
CC – Panel type	01 – SC SX/LC DX
	02 – FC/ST
DD – Adapters	6,12,24,36,48,72
E – Adapter class	1 – Standard One-Piece (or standard E2000, FC, ST)
	2 – Premium Super One-Piece
	3 – Premium One-Piece with internal shutter
	4 – Premium Super One-Piece with internal shutter
	5 – Premium (@FC, ST)
F – Adapter type	1 – SC
	2 – SCA
	3 – E2000
	4 – E2000 APC
	5 – LC
	6 – LCA
	7 – FC
	8 – FCA
	9 – ST
G – Transmission	1 – SM
	2 – MM (beige @SC/LC, black @E2000)
	3 – MM OM3 (aqua @SC/LC)
	4 – MM OM4 (violet @SC/LC)

HH – Pigtails qty	6,12,24,36,48
I – Fiber type	A – G.652D
	B – G.655
	C – G.656
	D – G.657A1
	E – G.657A2
	F – G.657B2
	G – G.657B3
	H – MM OM1
	I – MM OM2
	K – MM OM3
	L – MM OM4
JJ – Connector type	01 – SC
	02 – SCA
	03 – LC
	04 – LCA
	05 – FC
	06 – FCA
	07 – E2
	08 – E2A
	09 – ST
KK – Color identification	01 – for pigtails with yellow 0.9 mm buffer
	02 – for pigtails with orange 0.9 mm buffer
	03 – T TELECOM (acc. to IEC60304)
	04 – T1 TELECOM (acc. to 60304/tab. 3 & ZN-11/TPSA-005-02)
	05 – T2 TELECOM (acc. to EIA 598A)
	06 – D DATACOM (acc. to DIN VDE 0888 & IEC 60304)
	07 – D1 DATACOM (acc. to IEC 60304, TIA/EIA 598-A, TIA/EIA 598-C)
L – Splice trays number	1-6
M – Splice trays type	1 – SCM-A-12H
	2 – SCM-A-24H
NN – Heat shrink protection qty	6,12,24,36,48,72
O – Heat shrink protection type	1 – 45 mm
P – Cable gland qty	1-4
R – Cable gland type	1 – PG13.5
	2 – PG16

Example

PST-C1-01-101-12221-12A0201-11-112-12

FIBRAIN fiber optic patch panel, 1U, equipped with 1 front plate for 12x SC SX, Premium Super One-Piece SC APC adapters, 12 pigtails with SC APC connectors in Gold Grade with 2 m length in yellow buffer, G.652D fiber, 1 splice tray with 12F splice magazine, equipped with 12 heat shrink protections (45mm), 1 PG16 cable gland.

To order a non-standard option, please contact with our Sales Department.

PSR-A0 Pivot Swivel Panel



TECHNICAL SPECIFICATIONS

	PSR-A0-01	PSR-A0-02
Height	1U	2U
Maximal fiber qty	48	96
Maximal splice qty	48	96
Maximal splice cassette qty	2	4
Maximal line cable diameter [mm]	12	
Depth [mm]	315	
Operating temperature	-20°C – +50°C	
Casing material	Powder painted steel	

Ordering information

Code	Description
PSR-A0-01-R-00-00000-0000000-000	FIBRAIN 1U rotational patch panel, right side A0 version, non-equipped; grey (RAL7035)
PSR-A0-02-R-00-00000-0000000-000	FIBRAIN 2U rotational patch panel, right side A0 version, non-equipped; grey (RAL7035)
PSR-A0-B1-R-00-00000-0000000-000	FIBRAIN 1U rotational patch panel, right side A0 version, non-equipped; black (RAL 9005)
PSR-A0-B2-R-00-00000-0000000-000	FIBRAIN fiber optic patch panel, 1U, equipped with 1 front plate for 12x SC SX, Premium Super

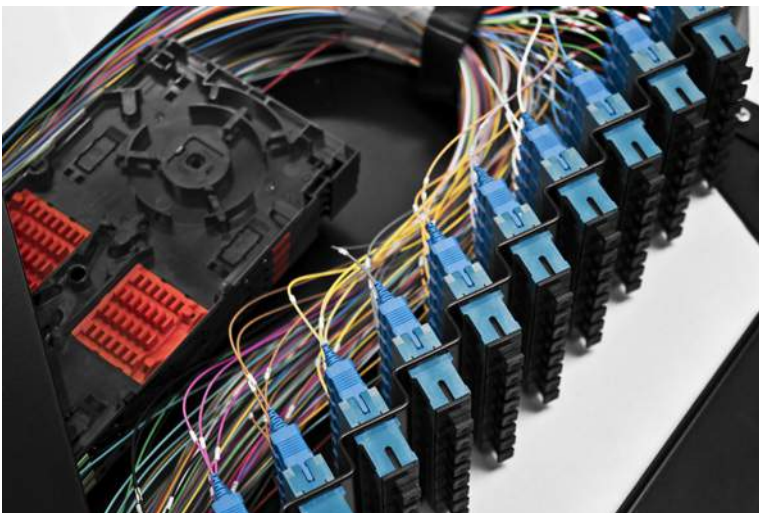

Fiber Optic Patch Panels

Description

- Rotational patch panel PSR-A0 type, in 1U or 2U version, is basic mounting block for fiber management system, in patch panel holder. Available in version routing on the left or right side, so it offers well accessibility to trays and patching cords on both sides. It minimizes and protect patch cords cables movement inside patch panels.
- Patch panel PSR-A0 offers trays patch cords in SC simplex standard for 48 fields in 1U version or 96 fields in 2U, available installation into 2 or 4 splice trays for 24 solders. Tray patch cords allow mount connector for 25 degree angle from the diagonal plane.

Applications

- Fiber optics interchanges points
- Distribution network
- Server room

Features

- Metal casing- anticorrosive protected
- Cable bushing in back parts of line cables
- Cable bushing in the front parts of patchcords
- Patch panel installation on a back or front rack profile
- Capacity up to
- 48 fibers in 1U
- 96 fibers in 2U
- Cable bushing in patch panel are equipped in brush guards
- Panel available rotating to left or right side of patch panel (depends on version)
- Offers separated canal for patch cord cables
- Possibilities termination line and local cables on aside or back of patch panel
- Hinged flap of patch panel, protects patch cords against damages

PSR-A0 Pivot Swivel Panel

Ordering syntax

PSR-A0-XX-A-BC-DDEFG-HHIJKLL-MMO

XX – Height variant	01	1U (grey RAL 7035)
	02	2U (grey RAL 7035)
	B1	1U (black RAL 9005)
	B2	2U (black RAL 9005)
A – Shelf opening direction	R	right
	L	left
B – Cassette qty	0-4	
C – Cassette type	1	SCM-A-24H
DD – Adapters qty:	1-48 (1U)	Unused ports are blinded
	1-96 (2U)	
E – Adapter class:	1	Standard One-Piece
	2	Premium One-Piece with internal shutter
	3	Premium Super One-Piece
	4	Premium Super One-Piece with internal shutter
F – Adapter type:	1	SC
	2	SCA
	3	E2
	4	E2A
G – Transmission	1	SM
	2	MM (beige @SC, black @E2000)
	3	MM OM3 (aqua @SC)
	4	MM OM4 (violet @SC)

HH – Pigtailed qty	0-96	
I – Fiber type	A	G.652D
	B	G.655
	C	G.656
	D	G.657A1
	E	G.657A2
	F	G.657B2
	G	G.657B3
	H	MM OM1
	I	MM OM2
	K	MM OM3
	L	MM OM4
	J – Connector type	1
2		SCA
3		E2
4		E2A
K – Pigtailed grade	S	Silver
	G	Gold
	T	Titanium
	01	for pigtailed with yellow 0.9 mm buffer
LL – Color identification	02	for pigtailed with orange 0.9 mm buffer
	03	T TELECOM (acc. to IEC60304)
	04	T1 TELECOM (acc. to 60304/tab. 3 & ZN-11/TPSA-005-02)
	05	T2 TELECOM (acc. to EIA 598A)
	06	D DATACOM (acc. to DIN VDE 0888 & IEC 60304)
	07	D1 DATACOM (acc. to IEC 60304, TIA/EIA 598-A, TIA/EIA 598-C)
	MM – Heat shrink protections qty	0-96
O – Heat shrink protections type	1	45 mm

Example

PSR-A0-02-R-41-96311-96A1G01-961 FIBRAIN rotational patch panel with side access, right, equipped with 4 splice cassettes for 24 splice protectors, 96 Gold grade pitails terminated with SC PC connectors, 2m length on G.652D fiber, 96 Premium Super One-Piece SC PC adapters and 96 splice protectors 45 mm.

To order a non-standard option, please contact with our Sales Department.

PS-19-1-3PS Modular Fiber Optic Patch Panel, 1U, chassis



PS-19-3-3PS CHASSIS	
Height	3U (133.35 mm)
Width [mm]	19" (484.6 mm)
Depth [mm]	255
Frame material	aluminium
PS-01-XX MODULE	
Length [mm]	220
Width [mm]	129
Depth [mm]	35
PS-M1-XX MODULE	
Length [mm]	220
Width [mm]	129
Depth [mm]	35



Description

- FIBRAIN 1U patch panels accommodate up to 36/72 fibers within space of 1U. Smart design allows easy and time saving installation and operation. Chassis is equipped with 3 slots enabling installation of 3 FO cassettes up to 12/24 fibers each. Special openings at the rear part of the chassis allows for FO cable fixation by strain relief
- Wide range of FO cassettes equipped with various kind of MM and SM adapters, pigtails or preterminated MTP/MPO solution (Direct Split)

Applications

- Telecommunication server rooms
- FTTH networks
- Metro networks
- Structural cabling systems
- Data Center systems

Features

- Capacity up to 36/72 fibers in 1U
- Lightweight and strong aluminium construction
- Modules ready to be mounted
- Facilitated mounting of fiber optic cable's tube
- Clear management of fiber optic

Ordering information

Code	Description
PS-19-1-3PS	1U Patch panel chassis with 3 slots for FO cassettes PS-01, PS-M1 types

Accessories

See page 140

PS-19-3-0.PRO Modular Fiber Optic Patch Panel, 3U, chassis

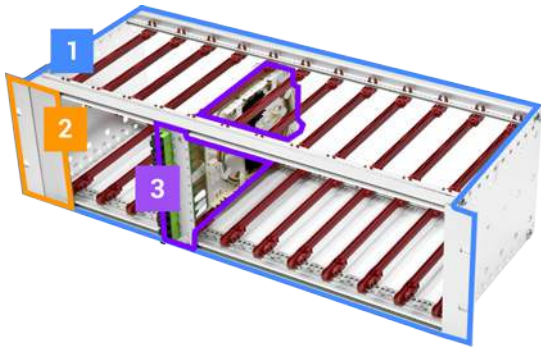

1. Chassis (frame)
2. Blind faceplate for unused ports
3. Matching cassettes for 3U patch panel

PS-19-3-0.PRO CHASSIS	
Height	3U (133.35 mm)
Width [mm]	436 (19")
Depth [mm]	160
Frame material	aluminium
Sliders material	ABS
PS-01-XX MODULE	
Length [mm]	220
Width [mm]	129
Depth [mm]	35
PS-M1-XX MODULE	
Length [mm]	220
Width [mm]	129
Depth [mm]	35



Description

- FIBRAIN 3U modular patch panels are solution facilitating termination up to 144/288 fibers in signal distribution points as well in server rooms. Smart design allows easy and time-saving way of installation and mounting of fiber optic cables. Main elements of this solution is frame of modular patch panel (chassis) and equipped 3U modular patch panel. Complete solution also offers patchcords management shelf, tubes and patchcords reserve shelf as well as fiber optic cables tubes separators.
- Additionally 3U modular patch panels can be provide with single modules equipped with MTP®/MPO Direct Split, which is perfect solution for Data Center application. Direct split allows to connect MTP multi-fiber connectors with standard, single-fiber optic connectors.

Applications

- Telecommunication server rooms
- FTTH networks
- Metro networks
- Structural cabling systems
- Data Center systems

Features

- Capacity up to 144/288 fibers in 3U
- Lightweight and strong aluminium construction
- Modules ready to be mounted
- Facilitated mounting of fiber optic cable's tube
- Clear management of fiber optic

Ordering information

Product	Reference number
Chassis – patch panel frame	PS-19-3-0.PRO
Matching cassettes	PS-01-xx & PS-M1-xx
Blind faceplate for unused ports	PS-00-P
Patchcords reserve shelf	PS-19-1-PAT (grey RAL 7035) PS-19-1-PAT-B (black RAL 9005)
Tubes reserve shelf	PS-19-1-TUB
Patchcords management shelf	PS-ORG-1-PP
Fiber optic cables tube separator	RT-01-xx, see page 140

PS-01 FO cassettes for modular patch panels 1U/3U, splice

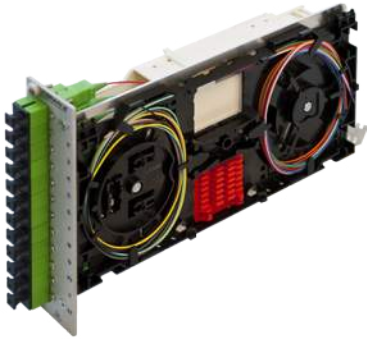

DIMENSIONS

Length [mm]	220
Width [mm]	129
Height [mm]	35

Front plates variants

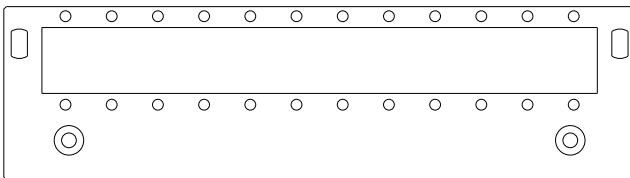

12xSC SX / E2000™ SX 6x LC DX (+6 blind covers)

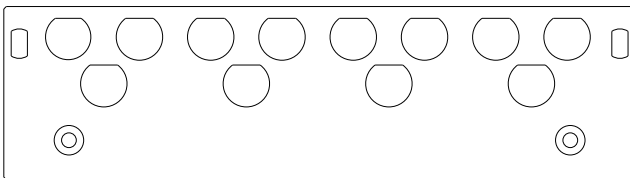

12xFC SX / ST SX

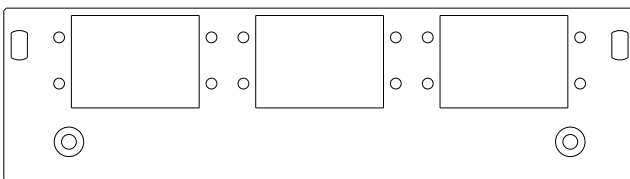

6 x LC 4X (LC quad)

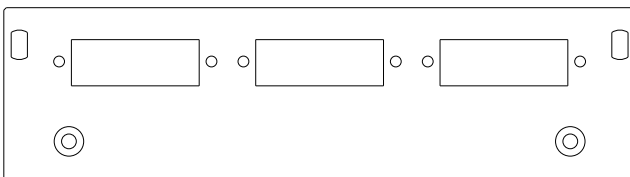

3 x LC 4X (LC quad)

Ordering information

Code	Description
PS-19-1-3PS	1U Patch panel chassis with 3 slots for FO cassettes PS-01, PS-M1 types

Description

- FIBRAIN PS-01 FO cassettes fits to FIBRAIN 1U/3U platforms (PS-19-1 & PS-19-e patch panels). They enables termination of max. 12/24 fibers. Cassette is equipped with a splice tray, splice magazines and heat shrink protections to store pigtails and protect fiber optic connections. It is factory equipped with adapters and pigtails of wide range of connectors type including SC/E2000/LC/FC/ST.

Applications

- Nodal points of fiber optic networks
- Distribution points of fiber optic networks
- Server rooms

Features

- Capacity up to 12/24 splices
- Modules ready to be mounted
- Fiber optic splice cassette made of ABS
- Facilitated identification and work due to 12 colours of pigtails
- Possibility to install fusion and mechanical splices in a fiber optic cassette
- Wide range of fiber optic adapters available

PS-01 FO cassettes for modular patch panels 1U/3U, splice

Ordering syntax

PS-01-**A**-**B**-**CCDEEF**-**GGHII**-**JJK**

A – Fiber type	A	SMF 652D
	B	SMF 655
	D	SMF 657A1
	E	SMF 657A2
	F	SMF 657A3
	G	SMF 657B3
	H	MM OM1
	I	MM OM2
	K	MM OM3
	L	MM OM4
B – Cassette type	1	SCM-A-12H
	2	FB7401PP (in case of use FB7401PP module size: 211x129x35.2 (Length x Width x Depth))
	3	SCM-A-24H
CC – Adapters qty	3-12 (single)	
D – Adapter class	1	Standard One-Piece (@E2000, FC, ST)
	1T	Standard One-Piece with transparent cap (only for SC APC)
	2	Premium One-Piece with internal shutter
	3	Premium Super-One Piece with internal shutter
EE – Adapter type	01	SC SX
	02	SCA SX
	03	E2 SX
	04	E2A SX
	05	LC 4X
	06	LCA 4X
	07	FC SX
	08	FCA SX
	09	ST SX

F – Transmission	1	SM
	2	MM (beige @SC/LC, black @E2000)
	3	MM OM3 (aqua @SC/LC)
	4	MM OM4 (violet @SC/LC)
GG – Pigtails qty	12-24	
H – Pigtail grade	S	Silver
	G	Gold
	T	Titanium
II – Color identification	01	for pigtails with yellow 0.9 mm buffer
	02	for pigtails with orange 0.9 mm buffer
	03	T TELECOM (acc. to IEC60304)
	04	T1 TELECOM (acc. to 60304/tab. 3 & ZN-11/TPSA-005-02)
	05	T2 TELECOM (acc. to EIA 598A)
	06	D DATACOM (acc. to DIN VDE 0888 & IEC 60304)
	07	D1 DATACOM (acc. to IEC 60304, TIA/EIA 598-A, TIA/EIA 598-C)
JJ – Splice protector qty	12-24	
K – Sleeve type	1-45 mm	

Example

PS-01-**A**-**1**-**121021**-**12G01**-**121**

FIBRAIN 3U patch panel module with pigtail reserve cassette, single, equipped with 12 SC APC Standard One-Piece adapters, 12 SC APC Gold Grade pigtails length: 2 m, 1 splice cassette for up to 12 sleeves and 12 splice protectors 45 mm

To order a non-standard option, please contact with our Sales Department.

PS-M1 FO cassettes for modular patch panels 1U/3U, MPO/MTP

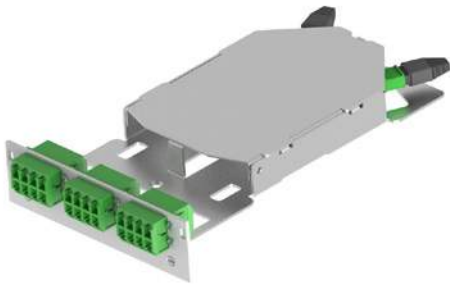

Description

- FIBRAIN PS-01 FO cassettes fits to FIBRAIN 1U/3U platforms (PS-19-1 & PS-19-e patch panels). They enables termination of max. 12/24 fibers. Cassette is equipped with a splice tray, splice magazines and heat shrink protections to store pigtails and protect fiber optic connections. It is factory equipped with adapters and pigtails of wide range of connectors type including SC/E2000/LC/FC/ST.

DIMENSIONS	
Length [mm]	220
Width [mm]	129
Height [mm]	35

Applications

- Nodal points of fiber optic networks
- Distribution points of fiber optic networks
- Server rooms

Front plates variants

Features

- Capacity up to 12/24 splices
- Plug & Play solution
- Fiber optic splice cassette made of ABS
- Wide range of fiber optic adapters available

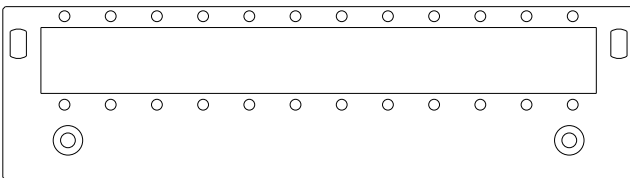

12xSC SX / E2000™ SX 6x LC DX (+6 blind covers)

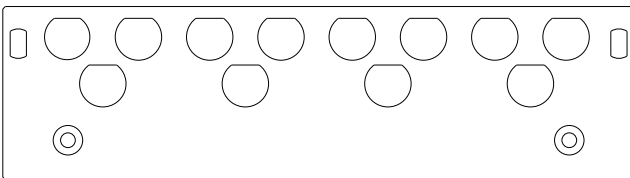

12xFC SX / ST SX

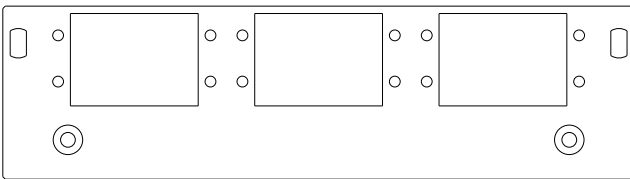

6 x LC 4X (LC quad)

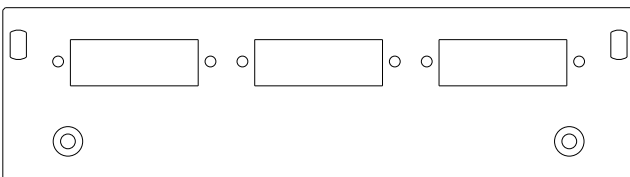

3 x LC 4X (LC quad)

PS-M1 FO cassettes for modular patch panels 1U/3U, MPO/MTP

Ordering syntax

PS-M1-**A**-**B**-**C**DEFGG-**I**JKKL-**MN**

A – Fiber type	A	SMF 652D
	B	SMF 655
	D	SMF 657A1
	E	SMF 657A2
	F	SMF 657A3
	G	SMF 657B3
	H	MM OM1
	I	MM OM2
	K	MM OM3
	L	MM OM4
B – Front panel type	1	12x SC SX/12x E2000 SX/6x LC DX (+ 6 blind covers between LC DX adapters)
	2	12x ST/FC
	3	6x LC 4X (6x LC QUAD)
	4	3x LC 4X (3x LC QUAD)
C – Direct Split qty	1	1 x DS in the module
	2	2 x DS in the module
D – Direct Split type	1	1x12
	2	1x24
E – Connectors Grade	G	Gold MTP®/MPO & Gold for single-fiber connectors
	T	Titanium MTP®/MPO & Titanium for single-fiber connectors
F – Connector type MTP®/MPO	1	MTP female APC
	2	MTP male APC
	3	MTP female MM
	4	MTP male MM

GG – Single-fiber connectors type	01	SC
	02	SC APC
	03	LC
	04	LC APC
	05	FC
	06	FC APC
	07	E2000
	08	E2000 APC
II – Adapters qty (front)	3-12	
J – Adapter class (front)	1	Standard One-Piece (@E2000, FC, ST too)
	1T	Standard One-Piece with transparent cap (only for SC APC)
	2	Premium One-Piece with internal shutter
	3	Premium Super One-Piece with internal shutter
KK – Adapter type (front)	01	SC SX
	02	SCA SX
	03	E2 SX
	04	E2A SX
	05	LC 4X
	06	LCA 4X
	07	FC SX
	08	FCA SX
	09	ST SX
L – Transmission	1	SM
	2	MM (beige @SC/LC, black @E2000)
	3	MM OM3 (aqua @SC/LC)
	4	MM OM4 (violet @SC/LC)
M – MTP®/MPO adapters qty	1-2	
N – MTP®/MPO adapters type	1	Type A
	2	Type B

Example

PS-M1-**A**-**5**-**11G104**-**031051**-**11**

FIBRAIN 3U patch panel module equipped with Direct Split, terminated with female MTP® connector and LC APC connectors on G.652D fiber type, 3 LC APC Standard One-Piece adapters and 1 MTP® Type A adapter

To order a non-standard option, please contact with our Sales Department.

SD modular patch panel, empty



TECHNICAL SPECIFICATIONS

Case material	Powder paint coated steel
Colour	Front: chrome-plated steel
	Closure: Black RAL 9005
Temperature range	-40°C to +70°C
Max. copper holders	4
Max. FO cassettes	8
Scope of supply	Frame, empty
Weight [kg]	2.1

Ordering information

Code	Description
XB100.2SD	SD modular patch panel, empty

Accessories

See page 140

Description

- SD patch panel is the most flexible platform for serve either copper or FO connection. It can be equipped up to 24 RJ45 ports of Cat5-Cat6A or up to 96 fibers terminated with wide range of connectors LC/E2000/SC. Patch panel has 8 empty slots which can be equipped with copper holder (6x RJ45) or fully equipped FO cassettes spliced or for pre-terminated connectors including MPO/MTP connectors.

Applications

- Nodal points of fiber optic networks
- Distribution points of fiber optic networks
- Server rooms

Features

- Modular configuration system:
 - Possibility for FO/Cu assembling,
 - Different cable entry adapters for different cables fixed in the rear
 - Patch cables manager from front (optional)
- Capacity: up to 8 FO/Cu modules
- Max ports density:
 - 24 port/1U for copper
 - 96 FO fibers (for LCd)
- Full range of connectors:
 - RJ45 – Cat.5u/s, Cat.6u/s, Cat.6Au/s
 - LCd, LCq, E2000, SC, SCd. – MM/SM

FO cassettes for SD patch panel



TECHNICAL SPECIFICATIONS

Case material	Powder paint coated steel
Colour	Front: chrome-plated steel
	Closure: Black RAL 9005
Temperature range	-40°C to +70°C
Max. copper holders	4
Max. FO cassettes	8
Scope of supply	Frame, empty
Weight [kg]	2.1

Ordering information

Code	Description
XB100.2SD	SD modular patch panel, empty

Description

→ SD cassettes are compact format FO cassettes which fit to modular SD platform panel of FIBRAIN. SD cassettes are available in wide range of variants. It exists in MM or SM versions, spliced or pre-terminated. Front can be equipped with variety of adapters (LCd, SC, E2000). SD cassettes also can be ordered for MPO/MTP connections.

Applications

- Nodal points of fiber optic networks
- Distribution points of fiber optic networks
- Server rooms

Features

- Fully assembled
- Wide range of front (LC/SD/E2000) and rear adapters (
- Singlemode or multimode versions
- Color coding acc. to ISO 11801
- Spliced or pre-terminated solution
- Up to 8 cassettes in 1U
- Secure cable/pigtail guides for internal connections

Ordering syntax

XB100.2SD.MF0-A-BCDE-FFGHII-J

A – Cassette front plate assembling	1	12x SC SX/LC DX
	2	6x SC SX/LC DX
	3	6x SC DX/LC 4X
	4	3x SC DX/LC 4X
B – Cassette rear side type	1	Empty (cassette equipped only with front adapters)
	2	Splice (cassette equipped with pigtails and front adapters)
	3	1x MPO/MTP 12F male (factory fully pre-connectorized solution)
	4	1x MPO/MTP 12F female (factory fully pre-connectorized solution)
	5	1x MPO/MTP 24F male (factory fully pre-connectorized solution)
	6	1x MPO/MTP 24F female (factory fully pre-connectorized solution)
	7	2x MPO/MTP 12F male (factory fully pre-connectorized solution)
	8	2x MPO/MTP 12F female (factory fully pre-connectorized solution)
C – Front adapter class	1	Standard One-Piece
	2	Premium Super One-Piece
	3	Premium One-Piece with internal shutter
	4	Premium Super One-Piece with internal shutter
D – Front adapter type	1	PC
	2	APC
E – Transmission	1	SM
	2	MM OM1
	3	MM OM2
	4	MM OM3
	5	MM OM4

FF – Pigtails qty	6, 12, 24	
G – Fiber type	A	G.652D
	B	G.655
	C	G.656
	D	G.657A1
	E	G.657A2
	F	G.657B2
	G	G.657B3
	H	MM OM1
	I	MM OM2
	J	MM OM3
	K	MM OM4
H – Pigtail grade	S	G.652D
	G	G.655
	T	G.656
II – Colour identification	01	G.652D
	02	G.655
	03	G.656
	04	G.657A1
	05	G.657A2
	06	G.657B2
	07	G.657B2
J – Splice heat shrink protection type	1	45 mm

Example

XB100.2SD.MF0-A-BCDE-FFGHII-J

FIBRAIN rotational patch panel with side access, right, equipped with 4 splice cassettes for 24 splice protectors, 96 Gold grade pigtails terminated with SC PC connectors, 2m length on G.652D fiber, 96 Premium Super One-Piece SC PC adapters and 96 splice protectors 45 mm.

To order a non-standard option, please contact with our Sales Department.

SD patch panel accessories

Blind cover 0.5U

Blind cover for front of SD patch panel



DIMENSIONS	
Length [mm]	220
Width [mm]	129
Height [mm]	35

ORDERING INFORMATION	
XB100.2SD.PPZ	Blind cover 0,5U

Blind cover 1U

Blind cover for rear of SD patch panel



DIMENSIONS	
Length [mm]	220
Width [mm]	129
Height [mm]	35

ORDERING INFORMATION	
XB100.2SD.PTZ	Blind cover 1U

Cable gland holder for SD patch panel

Cable gland holder for SD Patch panel. Holder can be installed to rear side of panel. It enables to fix 2 cable glands of Φ xx



DIMENSIONS	
Length [mm]	220
Width [mm]	129
Height [mm]	35

ORDERING INFORMATION	
XB100.2SD.PTD	Cable gland holder

Cable holder for SD panel

Cable holder enables fixation of cables/tubes which enter SD patch panel. Occupies one rear slot.



DIMENSIONS	
Length [mm]	220
Width [mm]	129
Height [mm]	35

ORDERING INFORMATION	
XB100.2SD.PTT	Blind cover 1U

Cable holder for SD panel, double

Cable holder intended for fixation of multitube cables. Enables easy installation and distribution tubes within the space of SD patch panel



DIMENSIONS	
Length [mm]	220
Width [mm]	129
Height [mm]	35

ORDERING INFORMATION	
XB100.2SD.PTT	Blind cover 1U

19" cable organizer

To arrange cables in SD patch panel. Equipped with a flip cover with a sticker that facilitates markings



DIMENSIONS	
Depth [mm]	69,5
Width [mm]	482
Height [mm]	44 (1U)

ORDERING INFORMATION	
XB100.2SD.ORG	19" cable organizer

19" patch panel accessories

Fiber Optic Patch Panels

Tubes reserve shelf



TECHNICAL SPECIFICATION	
Height [mm]	44 mm (1U)
Width [mm]	483 (19")
Depth [mm]	258
Casing material	Powder painted steel

Description

- FIBRAIN tubes reserve shelf offers simple and useful way of gathering and storage of fiber optic cable's tube. The shelf is equipped with telescopic rails, which provide a full opening to mount cables easily. Shelf's interior is equipped with a series of ribbing and perforation to provide easier management of fiber optic cable's tube.

ORDERING INFORMATION

PS-19-1-TUB	FIBRAIN tubes reserve shelf
--------------------	-----------------------------

Applications

- FTTH systems
- Last mile distribution points
- Last mile connection points

Features & benefits

- Full opening on telescopic rails
- Easy access to fiber optic cable's tube gathered
- Faster installation at construction side
- Shelf's interior facilitating installation and management

Patchcords reserve shelf



TECHNICAL SPECIFICATION	
Height [mm]	44 mm (1U)
Width [mm]	483 (19")
Depth [mm]	258
Casing material	Powder painted steel

Description

- FIBRAIN tubes reserve shelf offers simple and useful way of gathering and storage of fiber optic cable's tube. The shelf is equipped with telescopic rails, which provide a full opening to mount cables easily. Shelf's interior is equipped with a series of ribbing and perforation to provide easier management of fiber optic cable's tube.

ORDERING INFORMATION

PS-19-1-PAT	FIBRAIN tubes reserve shelf
--------------------	-----------------------------

Applications

- FTTH systems
- Last mile distribution points
- Last mile connection points

Features & benefits

- Full opening on telescopic rails
- Easy access to fiber optic cable's tube gathered
- Faster installation at construction side
- Shelf's interior facilitating installation and management

Horizontal fiber cable organizer



TECHNICAL SPECIFICATION	
Height [mm]	44 mm (1U)
Width [mm]	483 (19")
Depth [mm]	65
Casing material	Anodized aluminium + ABS

ORDERING INFORMATION	
PS-ORG-1-PP	FIBRAIN horizontal fiber optic cable organizer

Description

- FIBRAIN horizontal fiber optic cable organizer is a key elements which facilitate patchcords' management, which are placed between fiber optic equipment in distribution cabinets. This organizer ensures clean and transparent room. Therefore, the organizer is made from anodized aluminium and easily detachable handles made from ABS.

Applications

- Key points in fiber optic networks
- Distribution points of fiber optic networks
- Server rooms

Features & benefits

- Height 1U
- Width 19"
- Light and made of anodized aluminium housing
- Easy patchcord's organization
- Detachable handles facilitating cables placement

Patchcord management for PST-A1 telescopic patch panel

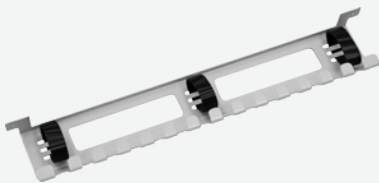

TECHNICAL SPECIFICATION	
Height [mm]	35
Width [mm]	423 (19")
Depth [mm]	77
Casing material	Powder coated steel

ORDERING INFORMATION	
FB2030G.V2P	FIBRAIN patchcord management for PST-A1 telescopic patch panel

Description

- FIBRAIN patchcord management for PST-A1 telescopic patch panel offers simple and useful way of gathering and storage patchcords overlength. FB2030G.V2P is mounted on front plates of PST-A1 patch panel (there is no need to add extra 1U height). Front plate with possibility to mount patchcords using velcro tape.

Applications

- FTTH systems
- Last mile distribution points
- Last mile connection points

Features & benefits

- Possibility of mounting on front plates of PST patch panel
- Easy access to patchcords gathered
- Faster installation at construction side
- Front plate facilitating installation and management

19" patch panel accessories

19" Horizontal cable organizer

with easily-opened plastic handles



TECHNICAL SPECIFICATION	
Height [mm]	44 mm (1U)
Width [mm]	483 (19")
Depth [mm]	69
Casing material	Powder painted steel

ORDERING INFORMATION	
ORG-VP-1U-B-V2	FIBRAIN horizontal cable organizer 19" with red front covers

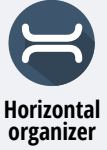
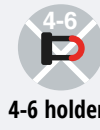

- Features**
- 19" mounting
 - Powder painted steel
 - Equipped with 4 easily opened-handles
 - Possibility of installing 2 extra handles
 - Clear manufacturer marking
 - Possibility of using together with vertical organizers
 - Guarantee optimum cable arrangement

19" Vertical cable organizer

with easily-opened plastic handles



TECHNICAL SPECIFICATION	
Height [mm]	44 mm (1U)
Width [mm]	483 (19")
Depth [mm]	69
Casing material	Powder painted steel

ORDERING INFORMATION	
ORG-HP-1U-B-V2	FIBRAIN vertical cable organizer 19" with red front cover

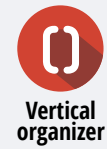
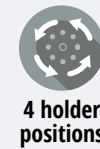

- Features**
- 1U mounting
 - Powder painted steel
 - Equipped with 1 easily opened-handle
 - Possibility of using holder in 4 positions
 - Clear manufacturer marking
 - Guarantee optimum cable arrangement

Velcro tape

16x200 10 pcs

FIBRAIN velcro tapes	
ORG-CT-16200-BK black	ORG-CT-16200-W white

- Features**
- Material: velour
 - Guarantee optimum cable arrangement
 - Pack of 10 pcs
 - Width: 16 mm - protected against excessive tightening
 - Resistant to multiple opening and closing
 - Colours facilitate cable identification

Cable tube divider RT-01-xx



TECHNICAL SPECIFICATIONS

	RT-01-0310	RT-01-1205	RT-01-2405
Max. number of protective pipes	3	12	24
Max. diameter of protective pipe [mm]	10	5	5
Max. diameter of fiber optic cable [mm]	14	14	18
Max. number of cable tube divider installed on Distribution Frame	8	8	4
Dimensions of a cable tube divider (w)x(h)x(l) [mm]	68 (with mounting) x 46 x 123 (no cable gland)	68 (with mounting) x 46 x 123 (no cable gland)	122 (with mounting) x 53 x 162.5 (no cable gland)
Operating temperature	-20°C – +50°C	-20°C – +50°C	-20°C – +50°C
Type of housing material	Powder painted steel	Powder painted steel	Powder painted steel

Description

- FIBRAIN cable tube divider is specifically designed to provide branchings of fiber optic cables and guarantee cables' tube protection, which run from RT-01-xx cable tube divider mounted on a Distribution Frame or a Tube Overlength Drawer in signal distribution points, as well in server rooms.
- Therefore, well-thought-out design provides easy and cost-effective method of mounting and cable installation.

Applications

- Nodal points of fiber optic networks
- Distribution points of fiber optic networks
- Server rooms and cable manufacturing centers

Features

- Metal housing, protected against corrosion
- Capacity up to 288 fibers
- Prepared for installation
- Simple and clear management of fiber optic tubes

Additional accessories

DISTRIBUTION FRAME

Distribution Frame for mounting cable tube divider	RT-L8-01-19	
---	-------------	---

PROTECTIVITE PIPES

Protectivite pipe 10 mm	OR3F-MYDSN-10-10
Protectivite pipe 5 mm	OFPT-5.0-3.1-PP-WHT

Ordering information

Code	Description
RT-01-0310	FIBRAIN cable tube divider equipped for mounting 3 protective pipes 10 mm
RT-01-1205	FIBRAIN cable tube divider equipped for mounting 12 protective pipes 5 mm
RT-01-2405	FIBRAIN cable tube divider equipped for mounting 24 protective pipes 5 mm

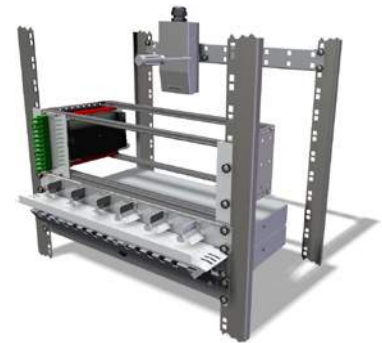

A view of cable tube divider installed on distribution frame

Heat-shrink splice protection sleeves



TECHNICAL SPECIFICATIONS

	RT-01-1205	RT-01-2405
Length of splice protector after shrink L [mm]	60	45
Length of wire reinforcement L _w [mm]	57	41
Diameter of splice protector after shrink D [mm]	2	2
Diameter of wire reinforcement D _w [mm]	0.75	0.75
Diameter of the through hole before shrink d [mm]	1.2	1.2

Ordering information

Code	Description
FB7441	Heat-shrink splice protection sleeves 60 mm
FB7442	Heat-shrink splice protection sleeves 45 mm

Also available

Code	Description
FB7445	ANT crimp splice prtector

Description

→ FIBRAIN FB7442 heat-shrink splice protection sleeves provide high protection during splicing process. They can be characterized by small inner diameter (diameter after shrink D=2.0mm), optimal length and fast installation. Therefore, the heat-shrink sleeve is strengthened with a steel pin of 0.75 mm diameter and the same coefficient of heat expansion as optical fiber. It prevents from longitudinal stresses, which cause an increase of insertion and reflection loss. FIBRAIN heat-shrink sleeves do not cause any loss of optical power as they protect against mechanical damages, pollution and weather conditions. Therefore, the outer material guarantees sustainability and resistance to stretching and puncture.

Applications

- Telecommunications systems
- FTTH networks
- Access and structured cable networks
- FTTx networks
- PON networks
- CATV networks

Features

- Small outer diameter
- Strengthened by a pin of Dd = 0.75 mm diameter
- In accordance with UL224, MIL-I-23053, GR-1380-CORE, ZN-96 TPSA-006 norms
- Transparent sleeve
- Max. shrink time: 40 s
- In accordance with RoHS Directive



DTX-PC6AS/MN
MAIN ISO11EC CAT 6a
PATCH CORD TEST ADAPTER

DTX-PC6AS/R
REMOTE ISO11EC CAT 6a
PATCH CORD TEST ADAPTER



EXIT F1 F2 F3 TEST

ENTER

SINGLE TEST AUTO TEST

FLUKE networks DTX-1800

PASS

TEST

FAIL

TAI

TO

TEST

**FIBER
OPTIC**



TERMINATION

TERMINATION OUTLETS

Wide range of FO termination outlets



EASY TO INSTALL



FULL CUSTOMIZATION



**LARGE & VISIBLE
LABEL FIELDS**



**SPLICE AND BREAKOUT
VERSIONS**

OUTLETS

for breakout and splice applications



WIDE RANGE
OF SUPPORTED
ADAPTER TYPES



GUARANTEED
BENDING RADIUS



SM/MM VERSIONS

VFTO-E1 Customer Outlet



TECHNICAL SPECIFICATIONS

Material:	ABS UL94-V0
Dimensions (w)x(h)x(d) [mm]:	85x85x28
Temperature:	-20°C – +50°C
Protection level:	indoor applications IP40/IK05
Mounting:	indoor, wall, rail (DIN standard) standard)
Cassette capacity:	4 fusion, 2 mechanical or 4 ANT splices
Fiber type:	15 mm bending radius, compatible with A1, A2, A3, B2, B3 standards
Length of extra fiber:	900 µm – 100 cm fiber in an outlet 250 µm – 200 cm fiber in an outlet
Entry ports:	1 entry port in each part of the outlet (1 port on a side) entries from outer part of an outlet (mounting on a flush mount box) all entry ports are defined by removing a blind adapter max. diameter of cables: 4mm

Ordering information

Code	Description
VFTO-E1-BL-0	FIBRAIN customer outlet in VFTO-E1 option, no logo, not equipped, no mounting adapter on a DIN rail

LOGO	
Code	Description
BL	no logo
FB	FIBRAIN logo
XX	Operator's logo (details concerning printing and number of colours need to be determined individually)

SUPPORT FOR VFTO-E1 OUTLET	
Code	Description
0	none
1	VFTO-E1-SUP-1
2	VFTO-E1-DIN-1

Description

→ VFTO-E1 customer outlet is specifically designed for FTTH networks as a termination point of an optical duct for max. 4 optical fibers in various home and business networks. The outlet facilitates placing and connecting cables with 2 x SC or 4 x LC pigtails with the use of splices in a cassette. Connectors can be of PC and APC standard with inner and outer shutters. In case of mounting adapters, flangeless adapters should be used.

Applications

- Distribution network
- FTTH networks with EAC cables
- Last mile connections
- Termination of FTTH networks

Features

- Compact and innovative design
- Indoor applications
- Wide range of fiber optic adapters
- Description field for adapters on a top part of an outlet with a transparent flip cover
- Available in a customer option (*lower labour costs)
- Possibility to personalize the outlet (logo)
- Possibility to mount on a DIN rail
- Adapter facilitates the mounting on a wall

25x50 angular faceplates

British style system



XB-50SC45I-01



XB-50ST45I-01

Description

- 25 x 50 mm angular faceplate for SC and ST fiber optic adapters installation.

Applications

- Distribution network
- FTTH networks with EAC cables
- Last mile connections
- Termination of FTTH networks

Technical specifications

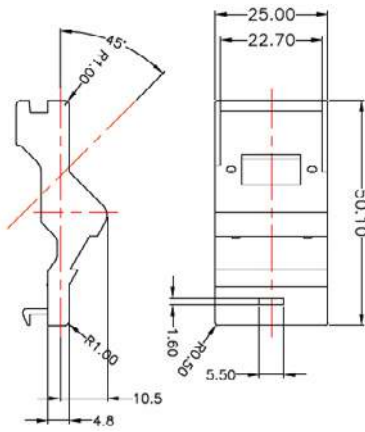

XB-50SC45I-01

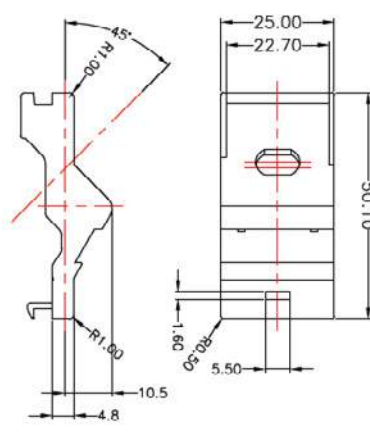

XB-50ST45I-01

Features

- Compatibility with XB-50FPB-0002/4 and XB-50FPF-0002/4 frames
- Labelling field
- Description field and identification icons
- Material: white ABS UL 94V-0

Ordering information

Code	Description
XB-50SC45I-01	FIBRAIN 25 x 50 mm angular adapter, 1 SC, interchangeable labelling field
XB-50ST45I-01	FIBRAIN 25 x 50 mm angular adapter, 1 ST, interchangeable labelling field

**FIBER
OPTIC**



FIBER OPTIC

FIBER OPTIC TEST

Necessary fiber optic accessories to be used by



**FO CLEANERS FOR WIDE
RANGE OF CONNECTORS**



**HIGH PERFORMANCE
ACCESSORIES FOR PROPER
TESTING OF FO LINKS**

TEST ACCESSORIES

ACCESSORIES

every Installer



REFERENCE TEST CORDS
FOR MM AND SM



REFERENCE PATCH CORDS
FOR ACCURATE TESTING

Reference master patchcords

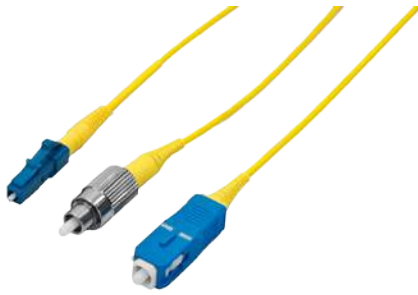

TECHNICAL SPECIFICATIONS		
Parameter	SM PC Connectors	SM APC Connectors
Insertion Loss ^{MAX} Acc. IEC 61300-3-34	≤ 0.10 dB	≤ 0.10 dB
Insertion Loss ^{97%} Acc. IEC 61300-3-34	≤ 0.07 dB	≤ 0.07 dB
Insertion Loss ^{MEAN} Acc. IEC 61300-3-34	≤ 0.05 dB	≤ 0.05 dB
Return Loss Acc. IEC 61300-3-6	≥ 55 dB	≥ 65 dB

MASTER CONNECTOR END FACE GEOMETRY		
Parameter	SM PC Connectors	SM APC Connectors
Concentricity	≤ 0.30 μm	≤ 0.30 μm
Bore angle	≤ 0.20 degree	≤ 0.20 degree
Apex Offset (AO)	≤ 30 μm	≤ 30 μm
Radius of Curvature (ROC)	10 ≤ ROC ≤ 20 mm @ SC 7 ≤ ROC ≤ 25 mm @ LC	7 ≤ ROC ≤ 12 mm
Fiber Height (FH)	-30.0 ≤ FH ≤ +30.0 nm	-30.0 ≤ FH ≤ +30.0 nm
Angle (AN)	-	7.7 ≤ AN ≤ 8.3 degree

Ordering information

ORDERING SYNTAX										
Series	Connector A		Connector B		Length [m]	Cable	Fiber	Diameter	Color	
	Class	Type	Class	Type						
MP	M Master	SC	M Master*	SC	001.0	SX patchcord simplex	A SMF G.652D	18 1.8mm	Y	■
		SCA	G Gold	SCA			D G657A1			
		LC		LC						
		LCA		LCA						
		FC		FC						
		FCA		FCA						
				E2						
				E2A						
				ST						
				MU						
		DIN								

Example

MP-MSCA-MSCA-002.0-SX-A-18-Y FIBRAIN Master Class Patchcord, with SC APC Master class Connectors at both side, simplex, 2m length, G.652D, cable diameter 1.8mm, yellow coat.

Description

- Master Class fiber optic patchcords are specifically designed to measure and test telecommunication networks and optical elements. The Master Patchcord is equipped with the highest quality master connector of tightly controlled concentricity and bore angle as well as the end face geometric parameters, which determine very low Insertion Loss and high connection repeatability.
- Optical measurements, in accordance with PN-EN 61280-4-2/-4-1, PN-ISO/IEC 14763-3, ITU-T G.650.3 require the use of the Master Class patchcord. Patchcords can be terminated with two connectors of Master Class or a mixed option: a connector of the Master Class - a standard connector, polished of the Gold Grade. FIBRAIN Master Class of fiber optic connectors can be characterized by very low Insertion Loss and increased control of the ferrule's and face geometry. The control over the end face geometry after polishing process of a fiber optic termination provides the following benefits: guarantees optical performance, minimizes IL, and minimizes back reflection.

Applications

- Measurements concerning telecommunication networks
- Testing optical devices
- Measuring equipment
- CWDM networks
- Local area network (LAN)
- FTTx, FTTD, FTTB, FTTH networks
- CATV solutions

Features

- Comply with IEC, TIA/EIA requirements,
- High quality and repeatability of the transmission parameters,
- High quality ceramic ferrules with tightly controlled concentricity and bore angle,
- Very low IL value, IL_{TYP} ≤ 0.05 dB,
- Connectors are constructed from high quality plastic, resistant to corrosion and high temperatures with UL94-V0 flammability index.

OSC – OTDR Starter Cube Launch Fiber



Description

→ FIBRAIN OSC - OTDR Starter Cube - facilitate reflectometric tests with the use of OTDR (Optical Time Domain Reflectometer). The launch fiber eliminates dead zone in reflectometer and guarantees secure measurement. FIBRAIN OSC OTDR Starter Cube has several advantages that make measurements fast and easy to perform. The housing is equipped with a magnet – OSC can be easily mounted on a rack and with shoulder strap – OSC can be easy to transport or moving. Launch fiber is terminated with master class connectors, available in a wide range of connector types. Compact housing can store up to 1000 m of fiber, available in SM or MM type.

Applications

→ SM and MM network's measurement
→ Simulation of loss, length, delayed time and system's reflectance

Features

→ Compact housing and small weight
→ Connector polishing type colour code for clear identification
→ Fiber colour code for easy identification
→ Input and output fanout made of reinforced harsh tube with crush resistance 1000N
→ Magnet mounting allows for mounting OSC to the rack
→ Master class connector for accurate and reliable measurement
→ Shoulder strap for easy measurement and transport
→ Anti-vibes protection

TECHNICAL SPECIFICATIONS

Parameter	ABS UL94-V0
Dimensions (w)x(h)	85x85x28
ILMAX @ 1310 nm (SM fiber)	-20°C – +50°C
ILMAX @ 1550 nm (SM fiber)	indoor applications IP40/IK05
ILMAX @ 850 nm (MM fiber)	indoor, wall, rail (DIN standard) standard
ILMAX @ 1300 nm (MM fiber)	-20°C – +50°C
SM Connector Insertion Loss (IEC 61300-3-4)	indoor applications IP40/IK05
MM Connector Insertion Loss (IEC 61300-3-4)	-20°C – +50°C
Return Loss (IEC 61300-3-6)	indoor applications IP40/IK05
Operating temperature	4 fusion, 2 mechanical or 4 ANT splices

Standard fiber lengths

MM Fibers	SM Fibers
100 m	100 m
300 m	300 m
	500 m
	1000 m

Ordering information

ORDERING SYNTAX

Series	Fiber type	Fanout	Connector type		Length [m]
			Input	Output	
S-Silver	A G.652D	1 - 1.8mm harsh	1 - E2	1 - E2	0100
	B SMF G655		2 - E2A	2 - E2A	
	D SMFG657A1		3 - FC	3 - FC	
	E SMF G657A2		4 - FCA	4 - FCA	
	H MMF OM1		5 - LC	5 - LC	
	MMF OM2		6 - LCA	6 - LCA	
	K MMF OM3		7 - SC	7 - SC	
	L MMF OM4		8 - SCA	8 - SCA	
			9 - ST	9 - ST	

*Standard colours of external tube for 1.6-2.8mm cables, other colours can be ordered by a customer on request. Colours in the table concern 0.9mm tube.

Example

OSC-A-88-0500 FIBRAIN OSC launch fiber, G.652D fiber, 1.8 mm reinforced harsh tube , SC APC connectors, length 500m

Cleaner cassette

FIBRAIN PRO-Cleaner



Description

→ The main advantage of cleaner cassette FIBRAIN PRO- Cleaners is their universal character of applications- as they can be used for different types of fiber optic connectors, regardless of the diameter of the ferrule. Reel-type cleaners are equipped with a tape with a sliding mechanism, so worn out tape has no contact with connectors that we are going to clean. Therefore, the fillers inside the reel-type cleaners can be easily replaced, which also reduces costs.

Applications

- Installation works in fiber optic networks
- Maintenance works in fiber optic networks
- Measuring works in fiber optic networks

Features

- Remove impurities from endface of fiber optic ferrules
- Clean various types of connectors
- Sliding mechanism protects from contact with worn out tape
- Option of replaceable fillers
- High efficiency
- Do not scratch surfaces

TECHNICAL SPECIFICATIONS

Reel-type cleaner	Connector	No. of cleanings	Dimensions	Photo
PC-02-UNV-500	SC/FC/ST/ E2000/LC/MU	500+	130x85x33 mm	
PC-02-UNV-500.R	SC/FC/ST/ E2000/LC/MU	500+	Ø47x20 mm	
PC-02-UNV-700	SC/FC/ST/ E2000/LC/MU	700+	125x56x28 mm	
PC-02-UNV-700.R	SC/FC/ST/ E2000/LC/MU	700+	114x53x25	

Ordering information

Code	Description
PC-02-UNV-500	FIBRAIN cleaner cassette PRO-Cleaner for fiber optic connectors, universal character of applications, 500+ cleanings
PC-02-UNV-500.R	FIBRAIN filler for cleaner cassette PC-02-UNV-500 PRO-Cleaner for fiber optic connectors, 500+ cleanings
PC-02-UNV-700	FIBRAIN cleaner cassette PRO-Cleaner for fiber optic connectors, universal character of applications, 700+ cleanings
PC-02-UNV-700.R	FIBRAIN filler for cleaner cassette PC-02-UNV-700 PRO-Cleaner for fiber optic adapters, 700+ cleanings

One-click FIBRAIN PRO-Cleaner



TECHNICAL SPECIFICATIONS				
One-click cleaner	Connector	No. of cleanings	Dimensions	Photo
PC-01-150-800	LC/MU	800+	200x25x25 mm	
PC-01-250-800	SC/FC/ST/E2000	800+	200x25x25 mm	
PC-01-150M-800	LC/MU	800+	110x30x18 mm	
PC-01-250M-800	SC/FC/ST/E2000	800+	110x30x18 mm	
PC-01-MPO-500	MPO/MTP®	500+	225x66x15 mm	
PC-01-150M-800	LC/MU	800+	110x30x18 mm	

Description

FIBRAIN one-click PRO-Cleaners ensure a very simple, fast and effective way to remove dust and other impurities from the ferrule endface. The series includes cleaning tools adapted to all types of fiber optic connectors - with 2.5 mm ferrules (SC / FC / ST / E2000 with SJ PC or APC), 1.25 mm (LC / MU with SJ PC or APC) and multi-fiber MPO / MTP® connectors. Automatic "one-click" connectors ensure cleaning without the need of unplugging adapters from patch panels. They are available in various options and sizes.

Applications

- Installation works in fiber optic networks
- Maintenance works in fiber optic networks
- Measuring works in fiber optic networks

Features

- Remove impurities from endface of fiber optic ferrules
- Available for connectors with ferrule of 2.5 mm, 1.25 mm and MPO/MTP®
- Provide cleaning of connectors that are plugged in patch panels, without the need of unplugging
- The cap for direct cleaning of connectors, which are not plugged in the adapter
- Available mini options that enable cleaning in hard to reach places
- High efficiency
- Do not scratch surfaces

Ordering information

Code	Description
PC-01-150-800	FIBRAIN one-click PRO-Cleaner for fiber optic connectors 1.25 mm (LC/MU), 800+ cleanings
PC-01-150M-800	FIBRAIN one-click PRO-Cleaner for fiber optic connectors 1.25 mm, mini housing, 800+ cleanings
PC-01-250-800	FIBRAIN one-click PRO-Cleaner for fiber optic connectors 2.5 mm, 800+ cleanings
PC-01-250M-800	FIBRAIN one-click PRO-Cleaner for fiber optic connectors 2.5 mm, mini housing, 800+ cleanings
PC-01-MPO-500	FIBRAIN one-click PRO-Cleaner for fiber optic connectors MPO/MTP®, 500+ cleanings
PC-01-MPO-700	FIBRAIN one-click PRO-Cleaner for fiber optic connectors MPO/MTP®, 700+ cleanings

Adapters cleaning sticks

FIBRAIN PRO-Cleaner



Ordering information

Code	Description
PC-03-125-S5	1.25 mm FIBRAIN PRO-Cleaner adapter cleaning sticks, set of 5 pcs
PC-03-250-S5	2.50 mm FIBRAIN PRO-Cleaner adapter cleaning sticks, set of 5 pcs

Description

→ FIBRAIN dust-free sticks for cleaning fiber optic adapters and in difficult to reach spots. Available in two sizes: for adapters with centering sleeve of 1.25 mm (LC / MU) and of 2.5 mm (SC / FC / ST / E2000). Maintaining clean centering sleeves determines proper optical parameters of the connection.

Applications

- Installation works in fiber optic networks
- Maintenance works in fiber optic networks
- Measuring works in fiber optic networks

Features

- Removes impurities from fiber optic adapters
- Available in two sizes: 1.25 mm and 2.5 mm
- Proper optical connection parameters due to removing dust from fiber optic adapters
- High efficiency
- Do not scratch surfaces



FIBRAIN POLAND

Rogoźnica 312
36-060 Głogów Małopolski
Poland

phone: +48 17 86 60 812
+48 17 86 60 813
+48 17 86 60 815

fax +48 17 86 60 811

e-mail: info@fibrain.com

FIBRAIN MÉXICO

Paseo de la Reforma 250 / Piso 9
Esquina c/Niza, Col. Juárez
Del. Cuahémoc
México D.F. 06600

phone: +52 55 3600 7546

e-mail: info@fibrain.com.mx

www.fibrain.com

FIBRAIN ®

X-ON Electronics

Largest Supplier of Electrical and Electronic Components

Click to view similar products for [Racks & Rack Cabinets](#) category:

Click to view products by [FIBRAIN](#) manufacturer:

Other Similar products are found below :

[1440-0131-78](#) [1440-0132-78](#) [1440-0133-36](#) [AX103928](#) [5231308-07](#) [C2FSKKBK1](#) [UPS 525-17-9 PLAIN](#) [UPS 350-17-12 PLAIN](#) [UNC-3-7-5-PLAIN](#) [UNC-23/4-6-6-PLAIN](#) [SN8VCMW](#) [R4PCNWH](#) [R4PWH](#) [R4P36CNWH](#) [R4P36WH](#) [NAKIT2.0G5-B](#) [RACK-2.18](#) [RACK-3.18](#) [SR14UBDP](#) [SR42UBDP48](#) [SR48UBDP48](#) [1440-0131-84](#) [UPS350 12-14 SEMI-GLOSS BLK](#) [UPH 350-12-14-BT](#) [UPR 525-17-14](#) [BLU/WHT](#) [RM1908BKVP](#) [RM2U19BKFP](#) [DN-WD19 12U/600](#) [1564A2BK1](#) [895-39949](#) [5231304-07](#) [18P3317](#) [18P4545](#) [HCT302411H](#) [HCT362011H](#) [HCT363011H](#) [HCT363611H](#) [HCT482411H](#) [HCT483011H](#) [HCT483611H](#) [HCT484814H](#) [1UHD722918N4SS](#) [RM3U19BKFP](#) [RM2U1918SBK](#) [2CLD83643](#) [2CLD84843](#) [2CLT204843](#) [RB-2PA1945NF](#) [RB-2PA1945BK](#) [RB-2PA2345NF](#)