

**Common features**

- Space saving 6.2 mm wide
- Connections for 16-way jumper link
- Integral coil indication and protection circuit
- Secure retention and easy ejection by plastic clip
- Dual screw head (blade+cross) terminals and Push-in terminals versions
- 35 mm rail mounting (EN 60715)

**MasterBASIC**

- For general use in any type of system
- **EMR: 6 to 24 and 125 V AC/DC, 230 V AC supply**
- **SSR: 6 to 24 V DC, 125 V AC/DC, 230 V AC supply**
- Screw terminal and Push-in terminal

**MasterBASIC - EMR ATEX**

- Available on request - See page 14

**MasterPLUS**

- Accepts the output fuse module, for the easy and space efficient protection of output circuits
- **EMR: 6 to 125 V AC/DC, 125 and 220 V DC, 230 V AC and 24...240 V AC/DC supply**
- **SSR: 24 - 125 V AC/DC, 6 to 220 V DC, 230 V AC and 24...240 V AC/DC supply**
- **Special 125 V AC/DC and 230 V AC leakage current suppression types (39.31.3, 39.61.3 EMR and 39.30.3, 39.60.3 SSR)**
- Screw terminal and Push-in terminal

**MasterINPUT**

- Jumper link option for the quick and easy distribution of supply voltage to proximity switches and similar input devices
- **EMR: 6 to 24 V and 125 V AC/DC, 230 V AC supply**
- **SSR: 6 - 24 V DC, 24 - 125 V AC/DC, 230 V AC supply**
- Screw terminal and Push-in terminal

**MasterOUTPUT**

- Jumper link option for the quick and easy distribution of supply voltage to output side and its connection to electromagnetic valves and similar output devices
- **EMR: 6 to 24 V and 125 V AC/DC, 230 V AC supply**
- **SSR: 6 to 24 V DC, 125 V AC/DC, 230 V AC supply**
- Screw terminal and Push-in terminal

**MasterTIMER**

- Timer adjustment via top mounted rotary knob accessible after assembly
- Control signal terminal
- DIP-switch for selection of 4 time scales and 8 functions
- Output with fuse module option
- **EMR and SSR: 12 to 24 V AC/DC supply**
- Screw terminal and Push-in terminal

**EMR  
Electromechanical Relays**

- **1 CO 6 A/250 V AC**
- High switching capability

**SSR  
Solid State Relays**

- 1 solid state output (options **0.1 A/48 V DC, 2 A/24 V DC, 2 A/240 V AC**)
- Silent, high speed switching, long electrical life

39.11/39.01



Page 4

39.10/39.00



Page 5

39.31 - 39.31.3/39.61 - 39.61.3

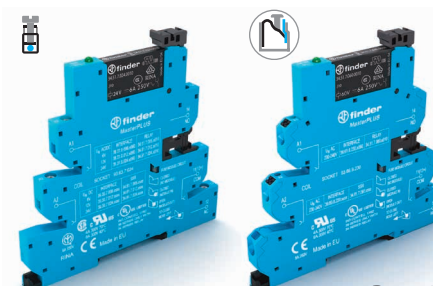

Page 6

39.30 - 39.30.3/39.60 - 39.60.3



Page 7

39.41/39.71



Page 8

39.40/39.70



Page 9

39.21/39.51



Page 10

39.20/39.50



Page 11

39.81/39.91

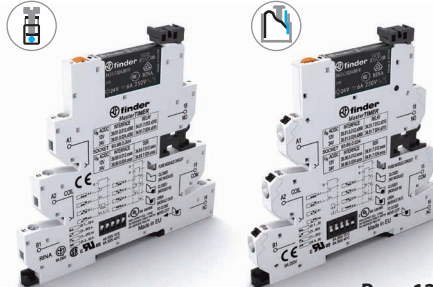

Page 12

39.80/39.90

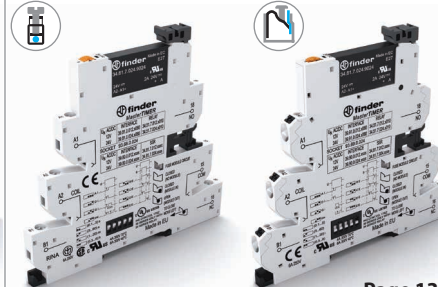

Page 13

**MasterBASIC**

**39.11 - 39.10 - 39.01 - 39.00**

- For general interface use in any type of system and application.
- Can be used for input interface applications between auxiliary contacts, sensors etc. and controllers, PLC's or motors. Or for output interface between PLC's controllers and relays, solenoids etc.

**MasterPLUS**

**39.31 - 39.30 - 39.31.3 - 39.30.3 - 39.61 - 39.60 - 39.61.3 - 39.60.3**

- This special version provides extra protection for the output circuit thanks to the replaceable fuse module.
- For general interface use in any type of system and application.
- Can be used for input interface applications between auxiliary contacts, sensors etc. and controllers, PLC's or motors. Or for output interface between PLC's controllers and relays, solenoids etc.

B

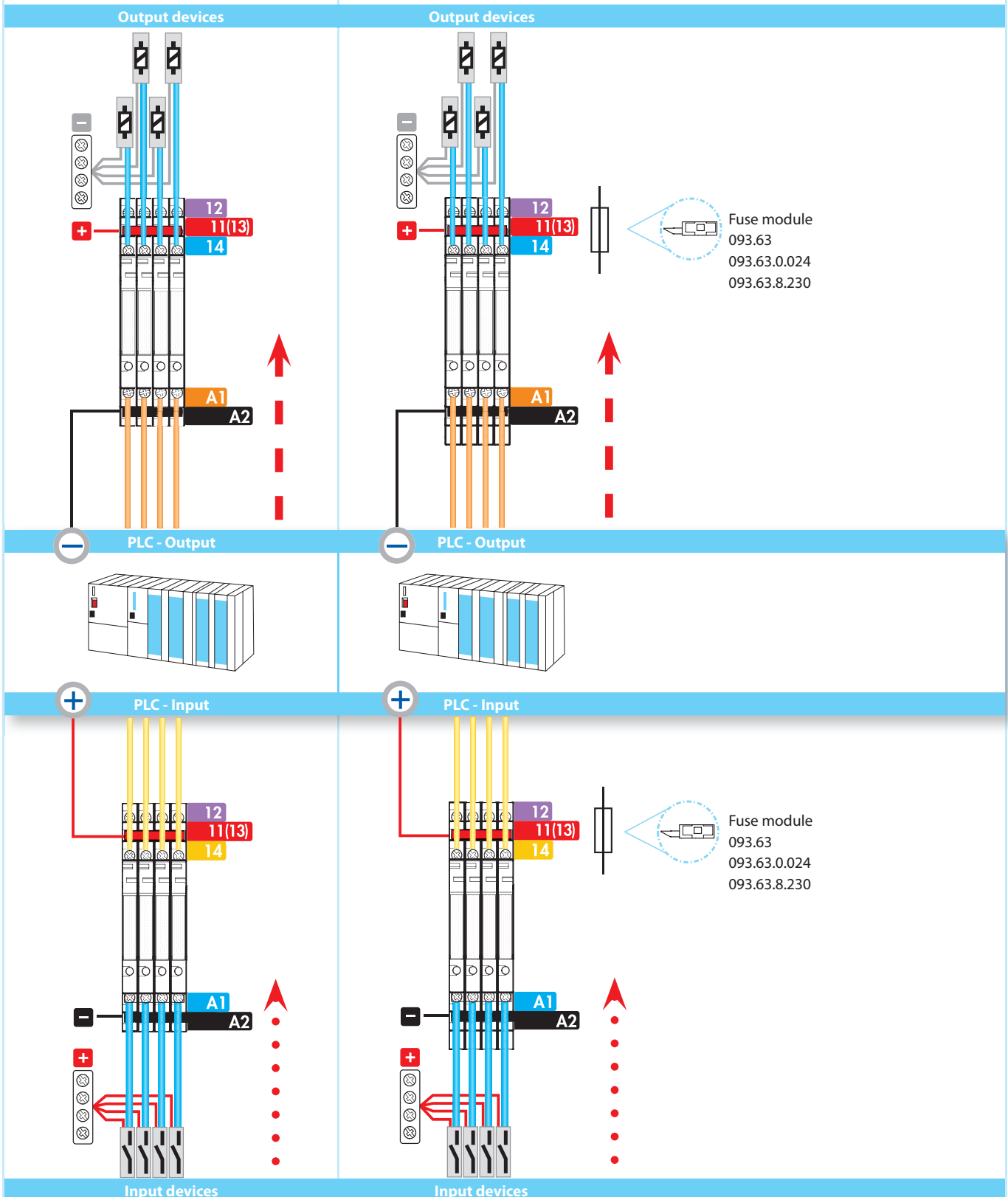

**MasterINPUT**

**39.41 - 39.40 - 39.71 - 39.70**

- These models allow the full termination of input device to the interface without the need for additional terminals - saving component cost, time and panel space.
- Quick and easy distribution of supply voltage through the jumper link on the Bus-Bar (BB) connection.
- Ideal for interface applications between the auxiliary contacts, sensors, limit switches and Controllers or PLC's.

**MasterOUTPUT**

**39.21 - 39.20 - 39.51 - 39.50**

- These models allow the full termination of output device to the interface without the need for additional terminals - saving component cost, time and panel space.
- Quick and easy distribution of supply voltage through the jumper link on the Bus-Bar (BB) connection.
- Ideal for interface applications between the PLC's or Controllers and output devices such as electromagnetic valves or motors etc..

**MasterTIMER**

**39.81 - 39.80 - 39.91 - 39.90**

- Slim and Multifunction Timed Interface modules.

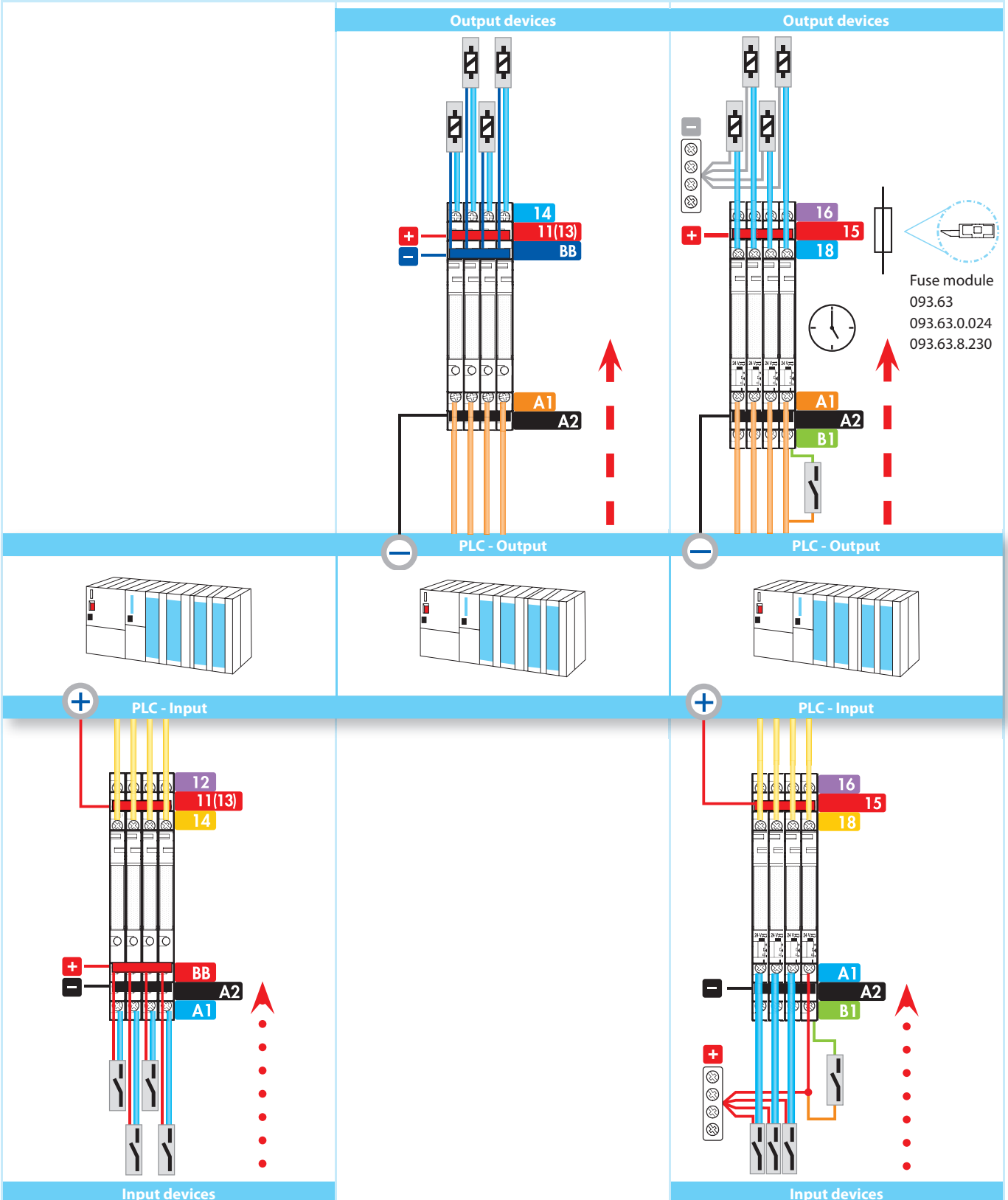

## MasterBASIC - EMR

1 Pole interface module, 6.2 mm wide, ideal for PLC and electronic systems

- Common connection possible with optional jumper links (terminals A1, A2 and 11)
- UL Listing (certain relay/socket combinations)

B



- 6 A electromechanical relay
- 6 to 24 and 125 V AC/DC and 230 V AC supply
- Screw terminal and push-in terminal
- 35 mm rail (EN 60715) mounting

39.11  
Screw terminal



39.01  
Push-in terminal

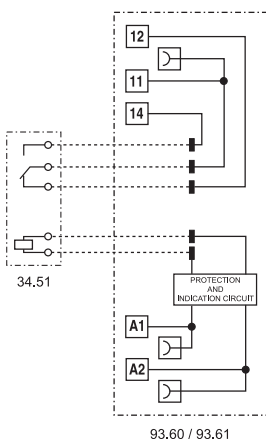

For outline drawing see page 22, 23

### Contact specification

|   |           |             |
|---|-----------|-------------|
| Contact configuration                       |           | 1 CO (SPDT) |
| Rated current/<br>Maximum peak current      | A         | 6/10        |
| Rated voltage/<br>Maximum switching voltage | V AC      | 250/400     |
| Rated load AC1                              | VA        | 1500        |
| Rated load AC15 (230 V AC)                  | VA        | 300         |
| Single phase motor rating (230 V AC)        | kW        | 0.185       |
| Breaking capacity DC1: 30/110/220 V         | A         | 6/0.2/0.12  |
| Minimum switching load                      | mW (V/mA) | 500 (12/10) |
| Standard contact material                   |           | AgNi        |

### Supply specification

|                           |                 |                         |
|---------------------------|-----------------|-------------------------|
| Nominal voltage ( $U_N$ ) | V AC/DC         | 6 - 12 - 24 - 110...125 |
|                           | V AC (50/60 Hz) | 220...240               |
| Rated power               | VA (50 Hz)/W    | See page 18             |
| Operating range           |                 | $(0.8...1.1)U_N$        |
| Holding voltage           |                 | $0.6 U_N$               |
| Must drop-out voltage     |                 | $0.1 U_N$               |

### Technical data

|   |              |                 |
|---|--------------|-----------------|
| Mechanical life AC/DC                                 | cycles       | $10 \cdot 10^6$ |
| Electrical life at rated load AC1                     | cycles       | $60 \cdot 10^3$ |
| Operate/release time                                  | ms           | 5/6             |
| Insulation between coil and contacts (1.2/50 $\mu$ s) | kV           | 6 (8 mm)        |
| Dielectric strength between open contacts             | V AC         | 1000            |
| Ambient temperature range                             | $^{\circ}$ C | -40...+70       |
| Protection category                                   |              | IP 20           |

Approvals relay (according to type)



### MasterBASIC - SSR

**1 Pole interface module, 6.2 mm wide, ideal for PLC and electronic systems**

- Common connection possible with optional jumper links (terminals A1, A2 and 13+)
- UL Listing (certain relay/socket combinations)



- 0.1 or 2 A solid state relay
- 6 to 24 and 125 V AC/DC and 230 V AC supply
- Screw terminal and push-in terminal
- 35 mm rail (EN 60715) mounting

39.10  
Screw terminal



39.00  
Push-in terminal

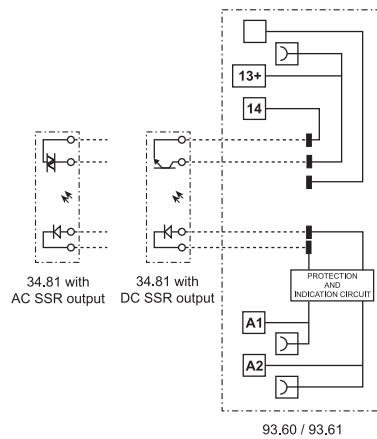

For outline drawing see page 22, 23

| <b>Output specification (SSR)</b>              |                 | <b>39.x0.x.xxx.9024</b>   | <b>39.x0.x.xxx.7048</b> | <b>39.x0.x.xxx.8240</b> |
|--|-----------------|---------------------------|-------------------------|-------------------------|
| Contact configuration                          |                 | 1 NO (SPST-NO)            |                         |                         |
| Rated current/<br>Maximum peak current (10 ms) | A               | 2/20 DC                   | 0.1/0.5 DC              | 2/40 AC                 |
| Rated voltage/<br>Maximum blocking voltage     | V               | 24/33 DC                  | 48/60 DC                | 240/— AC                |
| Switching voltage range                        | V               | (1.5...24) DC             | (1.5...48) DC           | (12...275) AC           |
| Repetitive peak off-state voltage              | V <sub>pk</sub> | —                         | —                       | 600                     |
| Minimum switching current                      | mA              | 1                         | 0.05                    | 22                      |
| Max. "OFF-state" leakage current               | mA              | 0.001                     | 0.001                   | 1.5                     |
| Max. "ON-state" voltage drop                   | V               | 0.12                      | 1                       | 1.6                     |
| <b>Supply specification</b>                    |                 |                           |                         |                         |
| Nominal voltage (U <sub>N</sub> )              | V AC/DC         | 110...125                 |                         |                         |
|  | V AC (50/60 Hz) | 220...240                 |                         |                         |
|  | V DC            | 6 - 12 - 24               |                         |                         |
| Rated power                                    | VA (50 Hz)/W    | See page 19               |                         |                         |
| Operating range                                |                 | (0.8...1.1)U <sub>N</sub> |                         |                         |
| Must drop-out voltage                          |                 | 0.1 U <sub>N</sub>        |                         |                         |
| <b>Technical data</b>                          |                 |                           |                         |                         |
| Operate/release time                           | ms              | 0.2/0.6                   | 0.04/0.6                | 12/12                   |
| Dielectric strength<br>between input/output    | V AC            | 2500                      |                         |                         |
| Ambient temperature range                      | °C              | -20...+55                 |                         |                         |
| Protection category                            |                 | IP 20                     |                         |                         |
| <b>Approvals relay</b> (according to type)     |                 |                           |                         |                         |



## MasterPLUS - EMR

1 Pole interface modules, 6.2 mm wide, ideal for PLC and electronic systems

- Accepts output fuse module **093.63**, **093.63.0.024**, **093.63.8.230** (for 5 x 20 mm fuses) for quick and easy load protection, see page 27
- Common connection possible with optional jumper links (terminals A1, A2 and 11)
- UL Listing (certain relay/socket combinations)

B



- 6 A electromechanical relay
- 6 to 125 V AC/DC, 125 and 220 V DC, 230 V AC, 24...240 V AC/DC supply
- Screw terminal and push-in terminal
- 35 mm rail (EN 60715) mounting



- 6 A electromechanical relay
- Leakage current suppression version, 125 V AC/DC and 230 V AC supply
- Screw terminal and push-in terminal

39.31/39.31.3  
Screw terminal



39.61/39.61.3  
Push-in terminal

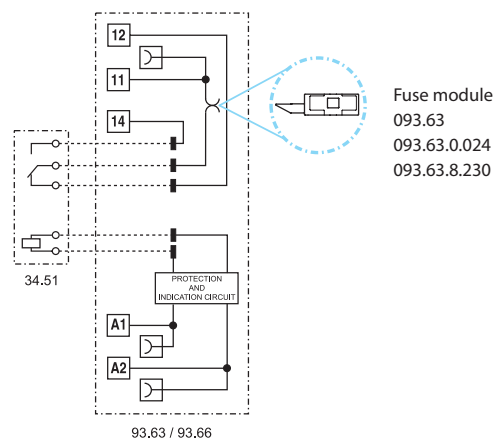

For outline drawing see page 22, 23

### Contact specification

|   |           | 1 CO (SPDT) | 1 CO (SPDT) |
|---|-----------|-------------|-------------|
| Contact configuration                       |           | 1 CO (SPDT) | 1 CO (SPDT) |
| Rated current/<br>Maximum peak current      | A         | 6/10        | 6/10        |
| Rated voltage/<br>Maximum switching voltage | V AC      | 250/400     | 250/400     |
| Rated load AC1                              | VA        | 1500        | 1500        |
| Rated load AC15 (230 V AC)                  | VA        | 300         | 300         |
| Single phase motor rating (230 V AC)        | kW        | 0.185       | 0.185       |
| Breaking capacity DC1: 30/110/220 V         | A         | 6/0.2/0.12  | 6/0.2/0.12  |
| Minimum switching load                      | mW (V/mA) | 500 (12/10) | 500 (12/10) |
| Standard contact material                   |           | AgNi        | AgNi        |

### Supply specification

|                                   |                 |   |                           |
|-----------------------------------|-----------------|---|---------------------------|
| Nominal voltage (U <sub>N</sub> ) | V AC/DC         | 6 - 12 - 24 - 60 - 110...125 - 24...240 | 110...125                 |
|                                   | V AC (50/60 Hz) | 220...240                               | 220...240                 |
|                                   | V DC            | 110...125 - 220                         | —                         |
| Rated power                       | VA (50 Hz)/W    | See page 18                             | See page 18               |
| Operating range                   |                 | (0.8...1.1)U <sub>N</sub>               | (0.8...1.1)U <sub>N</sub> |
| Holding voltage                   |                 | 0.6 U <sub>N</sub>                      | 0.6 U <sub>N</sub>        |
| Must drop-out voltage             |                 | 0.1 U <sub>N</sub>                      | 0.3 U <sub>N</sub>        |

### Technical data

|  |        |                              |                      |
|--|--------|------------------------------|----------------------|
| Mechanical life AC/DC                            | cycles | 10 · 10 <sup>6</sup>         | 10 · 10 <sup>6</sup> |
| Electrical life at rated load AC1                | cycles | 60 · 10 <sup>3</sup>         | 60 · 10 <sup>3</sup> |
| Operate/release time                             | ms     | 5/6                          | 5/6                  |
| Insulation between coil and contacts (1.2/50 μs) | kV     | 6 (8 mm)                     | 6 (8 mm)             |
| Dielectric strength between open contacts        | V AC   | 1000                         | 1000                 |
| Ambient temperature range                        | °C     | -40...+70 (+55 for 220 V DC) | -40...+70            |
| Protection category                              |        | IP 20                        | IP 20                |

Approvals relay (according to type)



### MasterPLUS - SSR

**1 Pole interface modules, 6.2 mm wide, ideal for PLC and electronic systems**

- Accepts output fuse module **093.63**, **093.63.0.024**, **093.63.8.230** (for 5 x 20 mm fuses) for quick and easy load protection, see page 27
- Common connection possible with optional jumper links (terminals A1, A2 and 13+)
- UL Listing (certain relay/socket combinations)



- 0.1 or 2 A solid state relay
- 24 - 125 V AC/DC, 6 to 220 V DC and 230 V AC, 24...240 V AC/DC supply
- Screw terminal and push-in terminal
- 35 mm rail (EN 60715) mounting



- 0.1 or 2 A solid state relay
- Leakage current suppression version, 125 V AC DC and 230 V AC supply
- Screw terminal and push-in terminal

39.30/39.30.3  
Screw terminal



39.60/39.60.3  
Push-in terminal

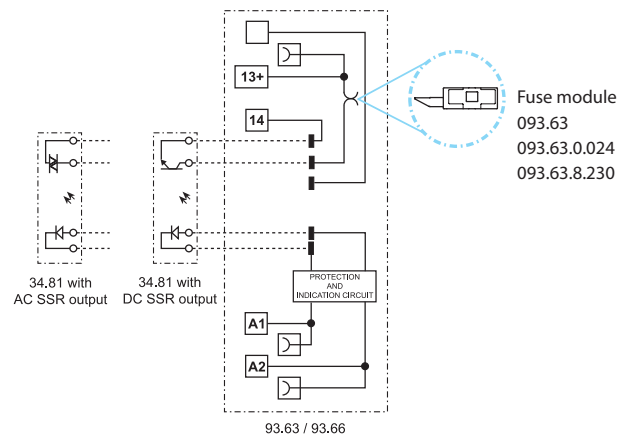

For outline drawing see page 22, 23

| <b>Output specification (SSR)</b>              |                 | <b>39.x0.x.xxx.9024</b>            | <b>39.x0.x.xxx.7048</b> | <b>39.x0.x.xxx.8240</b> | <b>39.x0.3.xxx.9024</b>   | <b>39.x0.3.xxx.7048</b> | <b>39.x0.3.xxx.8240</b> |
|--|-----------------|------------------------------------|-------------------------|-------------------------|---------------------------|-------------------------|-------------------------|
| Contact configuration                          |                 | 1 NO (SPST-NO)                     |                         |                         | 1 NO (SPST-NO)            |                         |                         |
| Rated current/<br>Maximum peak current (10 ms) | A               | 2/20 DC                            | 0.1/0.5 DC              | 2/40 AC                 | 2/20 DC                   | 0.1/0.5 DC              | 2/40 AC                 |
| Rated voltage/<br>Maximum blocking voltage     | V               | 24/33 DC                           | 48/60 DC                | 240/— AC                | 24/33 DC                  | 48/60 DC                | 240/— AC                |
| Switching voltage range                        | V               | (1.5...24) DC                      | (1.5...48)DC            | (12...275) AC           | (1.5...24) DC             | (1.5...48)DC            | (12...275) AC           |
| Repetitive peak off-state voltage              | V <sub>pk</sub> | —                                  | —                       | 600                     | —                         | —                       | 600                     |
| Minimum switching current                      | mA              | 1                                  | 0.05                    | 22                      | 1                         | 0.05                    | 22                      |
| Max. "OFF-state" leakage current               | mA              | 0.001                              | 0.001                   | 1.5                     | 0.001                     | 0.001                   | 1.5                     |
| Max. "ON-state" voltage drop                   | V               | 0.12                               | 1                       | 1.6                     | 0.12                      | 1                       | 1.6                     |
| <b>Supply specification</b>                    |                 |                                    |                         |                         |                           |                         |                         |
| Nominal voltage (U <sub>N</sub> )              | V AC/DC         | 24 - 110...125 - 24...240          |                         |                         | 110...125                 |                         |                         |
|  | V AC (50/60 Hz) | 220...240                          |                         |                         | 220...240                 |                         |                         |
|  | V DC            | 6 - 12 - 24 - 60 - 110...125 - 220 |                         |                         | —                         |                         |                         |
| Rated power                                    | VA (50 Hz)/W    | See page 19                        |                         |                         | See page 19               |                         |                         |
| Operating range                                |                 | (0.8...1.1)U <sub>N</sub>          |                         |                         | (0.8...1.1)U <sub>N</sub> |                         |                         |
| Must drop-out voltage                          |                 | 0.1 U <sub>N</sub>                 |                         |                         | 0.3 U <sub>N</sub>        |                         |                         |
| <b>Technical data</b>                          |                 |                                    |                         |                         |                           |                         |                         |
| Operate/release time                           | ms              | 0.2/0.6                            | 0.04/0.6                | 12/12                   | 0.2/0.6                   | 0.04/0.6                | 12/12                   |
| Dielectric strength<br>between input/output    | V AC            | 2500                               |                         |                         | 2500                      |                         |                         |
| Ambient temperature range                      | °C              | -20...+55                          |                         |                         | -20...+55                 |                         |                         |
| Protection category                            |                 | IP 20                              |                         |                         | IP 20                     |                         |                         |
| <b>Approvals relay</b> (according to type)     |                 |                                    |                         |                         |                           |                         |                         |

## MasterINPUT - EMR

1 Pole interface module, 6.2 mm wide, ideal for PLC and electronic systems

- Jumper link option for the quick and easy distribution of supply voltage to proximity switches and similar input devices (Bus-bar connection BB)
- Gold plated output contact as standard, for better compatibility with low energy PLC inputs
- UL Listing (certain relay/socket combinations)

B



- 6 A electromechanical relay
- 6 - 12 - 24 - 125 V AC/DC and 230 V AC supply
- Screw terminal and push-in terminal
- 35 mm rail (EN 60715) mounting

39.41  
Screw terminal



39.71  
Push-in terminal

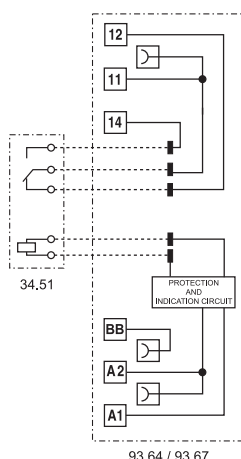

For outline drawing see page 22, 23

### Contact specification

|   |           |             |
|---|-----------|-------------|
| Contact configuration                       |           | 1 CO (SPDT) |
| Rated current/<br>Maximum peak current      | A         | 6/10        |
| Rated voltage/<br>Maximum switching voltage | V AC      | 250/400     |
| Rated load AC1                              | VA        | 1500        |
| Rated load AC15 (230 V AC)                  | VA        | 300         |
| Single phase motor rating (230 V AC)        | kW        | 0.185       |
| Breaking capacity DC1: 30/110/220 V         | A         | 6/0.2/0.12  |
| Minimum switching load                      | mW (V/mA) | 50 (5/2)    |
| Standard contact material                   |           | AgNi + Au   |

### Supply specification

|                           |                 |                         |
|---------------------------|-----------------|-------------------------|
| Nominal voltage ( $U_N$ ) | V AC/DC         | 6 - 12 - 24 - 110...125 |
|                           | V AC (50/60 Hz) | 220...240               |
| Rated power               | VA (50 Hz)/W    | See page 18             |
| Operating range           |                 | $(0.8...1.1)U_N$        |
| Holding voltage           |                 | $0.6 U_N$               |
| Must drop-out voltage     |                 | $0.1 U_N$               |

### Technical data

|   |              |                 |
|---|--------------|-----------------|
| Mechanical life AC/DC                                 | cycles       | $10 \cdot 10^6$ |
| Electrical life at rated load AC1                     | cycles       | $60 \cdot 10^3$ |
| Operate/release time                                  | ms           | 5/6             |
| Insulation between coil and contacts (1.2/50 $\mu$ s) | kV           | 6 (8 mm)        |
| Dielectric strength between open contacts             | V AC         | 1000            |
| Ambient temperature range                             | $^{\circ}$ C | -40...+70       |
| Protection category                                   |              | IP 20           |

Approvals relay (according to type)





## MasterINPUT - SSR

**1 Pole interface modules, 6.2 mm wide, ideal for PLC and electronic systems**

- Jumper link option for the quick and easy distribution of supply voltage to proximity switches and similar input devices (Bus-bar connection BB)
- UL Listing (certain relay/socket combinations)



- 0.1 or 2 A solid state relay
- 6 - 12 - 24 V DC, 24 - 125 V AC/DC and 230 V AC supply
- Screw terminal and push-in terminal
- 35 mm rail (EN 60715) mounting

39.40  
Screw terminal



39.70  
Push-in terminal

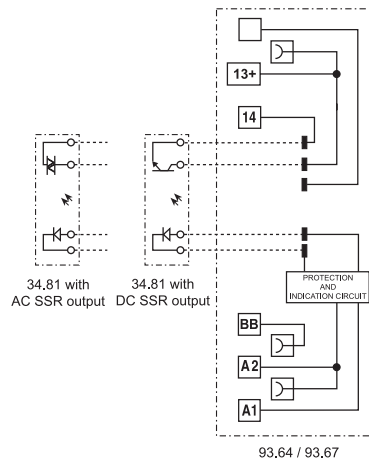

For outline drawing see page 22, 23

| <b>Output specification (SSR)</b>              |                 | <b>39.x0.x.xxx.9024</b>   | <b>39.x0.x.xxx.7048</b> | <b>39.x0.x.xxx.8240</b> |
|--|-----------------|---------------------------|-------------------------|-------------------------|
| Contact configuration                          |                 | 1 NO (SPST-NO)            |                         |                         |
| Rated current/<br>Maximum peak current (10 ms) | A               | 2/20 DC                   | 0.1/0.5 DC              | 2/40 AC                 |
| Rated voltage/<br>Maximum blocking voltage     | V               | 24/33 DC                  | 48/60 DC                | 240/— AC                |
| Switching voltage range                        | V               | (1.5...24) DC             | (1.5...48) DC           | (12...275) AC           |
| Repetitive peak off-state voltage              | V <sub>pk</sub> | —                         | —                       | 600                     |
| Minimum switching current                      | mA              | 1                         | 0.05                    | 22                      |
| Max. "OFF-state" leakage current               | mA              | 0.001                     | 0.001                   | 1.5                     |
| Max. "ON-state" voltage drop                   | V               | 0.12                      | 1                       | 1.6                     |
| <b>Supply specification</b>                    |                 |                           |                         |                         |
| Nominal voltage (U <sub>N</sub> )              | V AC/DC         | 24 - 110...125            |                         |                         |
|  | V AC (50/60 Hz) | 220...240                 |                         |                         |
|  | V DC            | 6 - 12 - 24               |                         |                         |
| Rated power                                    | VA (50 Hz)/W    | See page 19               |                         |                         |
| Operating range                                |                 | (0.8...1.1)U <sub>N</sub> |                         |                         |
| Must drop-out voltage                          |                 | 0.1 U <sub>N</sub>        |                         |                         |
| <b>Technical data</b>                          |                 |                           |                         |                         |
| Operate/release time                           | ms              | 0.2/0.6                   | 0.04/0.6                | 12/12                   |
| Dielectric strength<br>between input/output    | V AC            | 2500                      |                         |                         |
| Ambient temperature range                      | °C              | -20...+55                 |                         |                         |
| Protection category                            |                 | IP 20                     |                         |                         |
| <b>Approvals relay</b> (according to type)     |                 |                           |                         |                         |

## MasterOUTPUT - EMR

1 Pole interface modules, 6.2 mm wide, ideal for PLC and electronic systems

- Jumper link option for the quick and easy distribution of supply voltage to output side (Bus-bar connection BB) and its connection to electromagnetic valves and similar output devices
- UL Listing (certain relay/socket combinations)

B



- 6 A electromechanical relay
- 6 - 12 - 24 - 125 V AC/DC and 230 V AC supply
- Screw terminal and push-in terminal
- 35 mm rail (EN 60715) mounting

39.21  
Screw terminal



39.51  
Push-in terminal

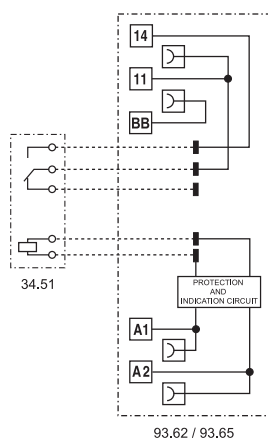

For outline drawing see page 22, 23

| Contact specification                            |                 |                           |
|--|-----------------|---------------------------|
| Contact configuration                            |                 | 1 NO (SPST-NO)            |
| Rated current/<br>Maximum peak current           | A               | 6/10                      |
| Rated voltage/<br>Maximum switching voltage      | V AC            | 250/400                   |
| Rated load AC1                                   | VA              | 1500                      |
| Rated load AC15 (230 V AC)                       | VA              | 300                       |
| Single phase motor rating (230 V AC)             | kW              | 0.185                     |
| Breaking capacity DC1: 30/110/220 V              | A               | 6/0.2/0.12                |
| Minimum switching load                           | mW (V/mA)       | 500 (12/10)               |
| Standard contact material                        |                 | AgNi                      |
| Supply specification                             |                 |                           |
| Nominal voltage (U <sub>N</sub> )                | V AC/DC         | 6 - 12 - 24 - 110...125   |
|  | V AC (50/60 Hz) | 220...240                 |
| Rated power                                      | VA (50 Hz)/W    | See page 18               |
| Operating range                                  |                 | (0.8...1.1)U <sub>N</sub> |
| Holding voltage                                  |                 | 0.6 U <sub>N</sub>        |
| Must drop-out voltage                            |                 | 0.1 U <sub>N</sub>        |
| Technical data                                   |                 |                           |
| Mechanical life AC/DC                            | cycles          | 10 · 10 <sup>6</sup>      |
| Electrical life at rated load AC1                | cycles          | 60 · 10 <sup>3</sup>      |
| Operate/release time                             | ms              | 5/6                       |
| Insulation between coil and contacts (1.2/50 μs) | kV              | 6 (8 mm)                  |
| Dielectric strength between open contacts        | V AC            | 1000                      |
| Ambient temperature range                        | °C              | -40...+70                 |
| Protection category                              |                 | IP 20                     |
| <b>Approvals relay</b> (according to type)       |                 |                           |
|  |                 |                           |

## MasterOUTPUT - SSR

**1 Pole interface modules, 6.2 mm wide, ideal for PLC and electronic systems**

- Jumper link option for the quick and easy distribution of supply voltage to output side (Bus-bar connection BB) and its connection to electromagnetic valves and similar output devices
- UL Listing (certain relay/socket combinations)



- 0.1 or 2 A solid state relay
- 6 to 24 V DC, 125 V AC/DC and 230 V AC supply
- Screw terminal and push-in terminal
- 35 mm rail (EN 60715) mounting

39.20  
Screw terminal



39.50  
Push-in terminal

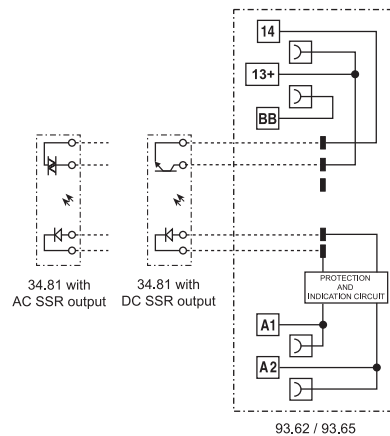

For outline drawing see page 22, 23

| <b>Output specification (SSR)</b>              |                 | <b>39.x0.x.xxx.9024</b>   | <b>39.x0.x.xxx.7048</b> | <b>39.x0.x.xxx.8240</b> |
|--|-----------------|---------------------------|-------------------------|-------------------------|
| Contact configuration                          |                 | 1 NO (SPST-NO)            |                         |                         |
| Rated current/<br>Maximum peak current (10 ms) | A               | 2/20 DC                   | 0.1/0.5 DC              | 2/40 AC                 |
| Rated voltage/<br>Maximum blocking voltage     | V               | 24/33 DC                  | 48/60 DC                | 240/— AC                |
| Switching voltage range                        | V               | (1.5...24) DC             | (1.5...48) DC           | (12...275) AC           |
| Repetitive peak off-state voltage              | V <sub>pk</sub> | —                         | —                       | 600                     |
| Minimum switching current                      | mA              | 1                         | 0.05                    | 22                      |
| Max. "OFF-state" leakage current               | mA              | 0.001                     | 0.001                   | 1.5                     |
| Max. "ON-state" voltage drop                   | V               | 0.12                      | 1                       | 1.6                     |
| <b>Supply specification</b>                    |                 |                           |                         |                         |
| Nominal voltage (U <sub>N</sub> )              | V AC/DC         | 110...125                 |                         |                         |
|  | V AC (50/60 Hz) | 220...240                 |                         |                         |
|  | V DC            | 6 - 12 - 24               |                         |                         |
| Rated power                                    | VA (50 Hz)/W    | See page 19               |                         |                         |
| Operating range                                |                 | (0.8...1.1)U <sub>N</sub> |                         |                         |
| Must drop-out voltage                          |                 | 0.1 U <sub>N</sub>        |                         |                         |
| <b>Technical data</b>                          |                 |                           |                         |                         |
| Operate/release time                           | ms              | 0.2/0.6                   | 0.04/0.6                | 12/12                   |
| Dielectric strength<br>between input/output    | V AC            | 2500                      |                         |                         |
| Ambient temperature range                      | °C              | -20...+55                 |                         |                         |
| Protection category                            |                 | IP 20                     |                         |                         |
| <b>Approvals relay</b> (according to type)     |                 |                           |                         |                         |

## MasterTIMER - EMR

Slim timed interface module, 6.2 mm wide, ideal for space-saving timing solutions in panels

- Timer adjustment via top mounted rotary knob, accessible after assembly
- Control signal terminal
- DIP-switch for selection of 4 time scales and 8 functions
- Accepts output fuse module **093.63**, **093.63.0.024**, **093.63.8.230** (for 5 x 20 mm fuses) for quick and easy load protection, see page 27
- Common connection possible with optional jumper links (terminals A1, A2 and 15)
- UL Listing (certain relay/socket combinations)

B



- 6 A electromechanical relay
- 12 - 24 V AC/DC supply
- Screw terminal and push-in terminal
- 35 mm rail (EN 60715) mounting

39.81  
Screw terminal



39.91  
Push-in terminal

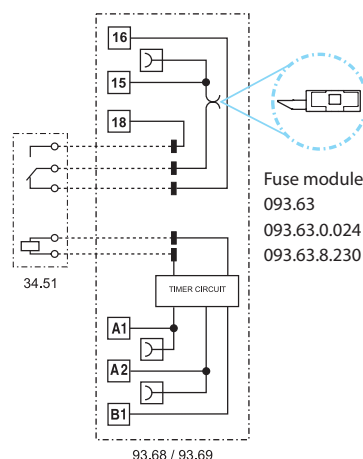

- AI:** On-delay
- DI:** Interval
- GI:** Pulse (0.5 s) delayed
- SW:** Symmetrical flasher (starting pulse on)
- BE:** Off-delay with control signal
- CE:** On- and off-delay with control signal
- DE:** Interval with control signal on
- EE:** Interval with control signal off

For outline drawing see page 22, 23

### Contact specification

|   |           |             |
|---|-----------|-------------|
| Contact configuration                       |           | 1 CO (SPDT) |
| Rated current/<br>Maximum peak current      | A         | 6/10        |
| Rated voltage/<br>Maximum switching voltage | V AC      | 250/400     |
| Rated load AC1                              | VA        | 1500        |
| Rated load AC15 (230 V AC)                  | VA        | 300         |
| Single phase motor rating (230 V AC)        | kW        | 0.185       |
| Breaking capacity DC1: 30/110/220 V         | A         | 6/0.2/0.12  |
| Minimum switching load                      | mW (V/mA) | 500 (12/10) |
| Standard contact material                   |           | AgNi        |

### Supply specification

|                                   |              |                           |
|-----------------------------------|--------------|---------------------------|
| Nominal voltage (U <sub>N</sub> ) | V AC/DC      | 12 - 24                   |
| Rated power AC/DC                 | VA (50 Hz)/W | See page 18               |
| Operating range                   |              | (0.8...1.1)U <sub>N</sub> |
| Holding voltage                   |              | 0.6 U <sub>N</sub>        |
| Must drop-out voltage             |              | 0.1 U <sub>N</sub>        |

### Technical data

|                                   |        |  |
|-----------------------------------|--------|--|
| Specified time range              |        | (0.1...3)s, (3...60)s, (1...20)min, (0.3...6)h |
| Repeatability                     | %      | ± 1  |
| Recovery time                     | ms     | ≤ 50   |
| Minimum control impulse           | ms     | 50   |
| Setting accuracy - full range     | %      | 5  |
| Electrical life at rated load AC1 | cycles | 60 · 10 <sup>3</sup>                           |
| Ambient temperature range         | °C     | -20...+50                                      |
| Protection category               |        | IP 20  |

Approvals relay (according to type)





## MasterTIMER - SSR

**Slim timed interface module, 6.2 mm wide, ideal for space-saving timing solutions in panels**

- Timer adjustment via top mounted rotary knob; accessible after assembly
- Start terminal
- DIP-switch for selection of 4 time scales and 8 functions
- Accepts output fuse module **093.63**, **093.63.0.024**, **093.63.8.230** (for 5 x 20 mm fuses) for quick and easy load protection, see page 27
- Common connection possible with optional jumper links (terminals A1, A2 and 15+)
- UL Listing (certain relay/socket combinations)



- 0.1 or 2 A solid state relay
- 12 - 24 V AC/DC supply
- Screw terminal and push-in terminal
- 35 mm rail (EN 60715) mounting

39.80  
Screw terminal



39.90  
Push-in terminal

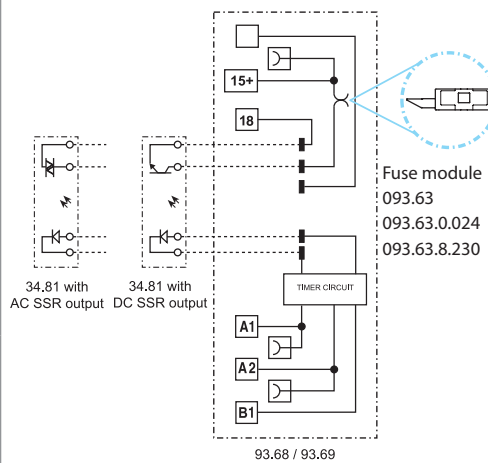

- AI:** On-delay
- DI:** Interval
- GI:** Pulse (0.5 s) delayed
- SW:** Symmetrical flasher (starting pulse on)
- BE:** Off-delay with control signal
- CE:** On- and off-delay with control signal
- DE:** Interval with control signal on
- EE:** Interval with control signal off

For outline drawing see page 22, 23

| Output specification (SSR)                     |                 | 39.x0.x.xxx.9024                               | 39.x0.x.xxx.7048 | 39.x0.x.xxx.8240 |
|--|-----------------|--|------------------|------------------|
| Contact configuration                          |                 | 1 NO (SPST-NO)                                 |                  |                  |
| Rated current/<br>Maximum peak current (10 ms) | A               | 2/20 DC  | 0.1/0.5 DC       | 2/40 AC          |
| Rated voltage/<br>Maximum blocking voltage     | V               | 24/33 DC                                       | 48/60 DC         | 240/— AC         |
| Switching voltage range                        | V               | (1.5...24) DC                                  | (1.5...48) DC    | (12...275) AC    |
| Repetitive peak off-state voltage              | V <sub>pk</sub> | —  | —                | 600              |
| Minimum switching current                      | mA              | 1  | 0.05             | 22               |
| Max. "OFF-state" leakage current               | mA              | 0.001  | 0.001            | 1.5              |
| Max. "ON-state" voltage drop                   | V               | 0.12   | 1                | 1.6              |
| <b>Supply specification</b>                    |                 |  |                  |                  |
| Nominal voltage (U <sub>N</sub> )              | V AC/DC         | 12 - 24  |                  |                  |
| Rated power                                    | VA (50 Hz)/W    | See page 19                                    |                  |                  |
| Operating range                                |                 | (0.8...1.1)U <sub>N</sub>                      |                  |                  |
| Holding voltage                                |                 | 0.6 U <sub>N</sub>                             |                  |                  |
| Must drop-out voltage                          |                 | 0.1 U <sub>N</sub>                             |                  |                  |
| <b>Technical data</b>                          |                 |  |                  |                  |
| Specified time range                           |                 | (0.1...3)s, (3...60)s, (1...20)min, (0.3...6)h |                  |                  |
| Repeatability                                  | %               | ± 1  |                  |                  |
| Recovery time                                  | ms              | ≤ 50   |                  |                  |
| Minimum control impulse                        | ms              | 50   |                  |                  |
| Setting accuracy - full range                  | %               | 5  |                  |                  |
| Ambient temperature range                      | °C              | -20...+50                                      |                  |                  |
| Protection category                            |                 | IP 20  |                  |                  |
| <b>Approvals relay</b> (according to type)     |                 |  |                  |                  |



## MasterBASIC - EMR ATEX

1 Pole interface module, 6.2 mm wide, ideal for PLC and electronic systems

### ATEX compliant (EX nA nC)

- Electromechanical relay
- AC, DC and AC/DC Version
- Screw terminal and Push-in terminal
- UL Listed
- Cadmium free contacts
- Complies with:
  - EN 60079-0: 2012 and EN 60079-15:2010
  - 94/9/CE and 2014/34/UE
- Common connection possible with optional jumper links (terminals A1, A2 and 11) and multipole connector **MasterADAPTER**
- 35 mm rail (EN 60715) mounting



- 1 CO 6 A
- Screw terminal and push-in terminal
- 35 mm rail (EN 60715) mounting
- ATEX compliant

39.11  
Screw terminal



39.01  
Push-in terminal

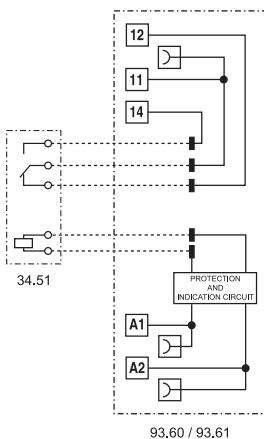

93.60 / 93.61

For outline drawing see page 22, 23

### Contact specification

|   |           |             |
|---|-----------|-------------|
| Contact configuration                       |           | 1 CO (SPDT) |
| Rated current/<br>Maximum peak current      | A         | 6/10        |
| Rated voltage/<br>Maximum switching voltage | V AC      | 250/400     |
| Rated load AC1                              | VA        | 1500        |
| Rated load AC15 (230 V AC)                  | VA        | 300         |
| Single phase motor rating (230 V AC)        | kW        | 0.185       |
| Breaking capacity DC1: 30/110/220 V         | A         | 6/0.2/0.12  |
| Minimum switching load                      | mW (V/mA) | 500 (12/10) |
| Standard contact material                   |           | AgNi        |

### Coil specification

|                           |                 |                                    |
|---------------------------|-----------------|------------------------------------|
| Nominal voltage ( $U_N$ ) | V AC/DC         | 6 - 12 - 24 - 110...125 - 24...240 |
|                           | V AC (50/60 Hz) | 230...240                          |
|                           | V DC            | 6 - 12 - 24                        |
| Rated power AC/DC         | VA (50 Hz)/W    | See page 18                        |
| Operating range           |                 | $(0.8...1.1)U_N$                   |
| Holding voltage           |                 | $0.6 U_N$                          |
| Must drop-out voltage     |                 | $0.1 U_N$                          |

### Technical data

|   |              |                 |
|---|--------------|-----------------|
| Mechanical life AC/DC                                 | cycles       | $10 \cdot 10^6$ |
| Electrical life at rated load AC1                     | cycles       | $60 \cdot 10^3$ |
| Operate/release time                                  | ms           | 5/6             |
| Insulation between coil and contacts (1.2/50 $\mu$ s) | kV           | 6 (8 mm)        |
| Dielectric strength between open contacts             | V AC         | 1000            |
| Ambient temperature range                             | $^{\circ}$ C | -40...+70       |
| Protection category                                   |              | IP 20           |

Approvals relay (according to type)



### Ordering information ATEX versions

Example: 39 series, screw terminals interface module, electromechanical relay output, 1 CO 6 A, 24 V DC, ATEX Version.

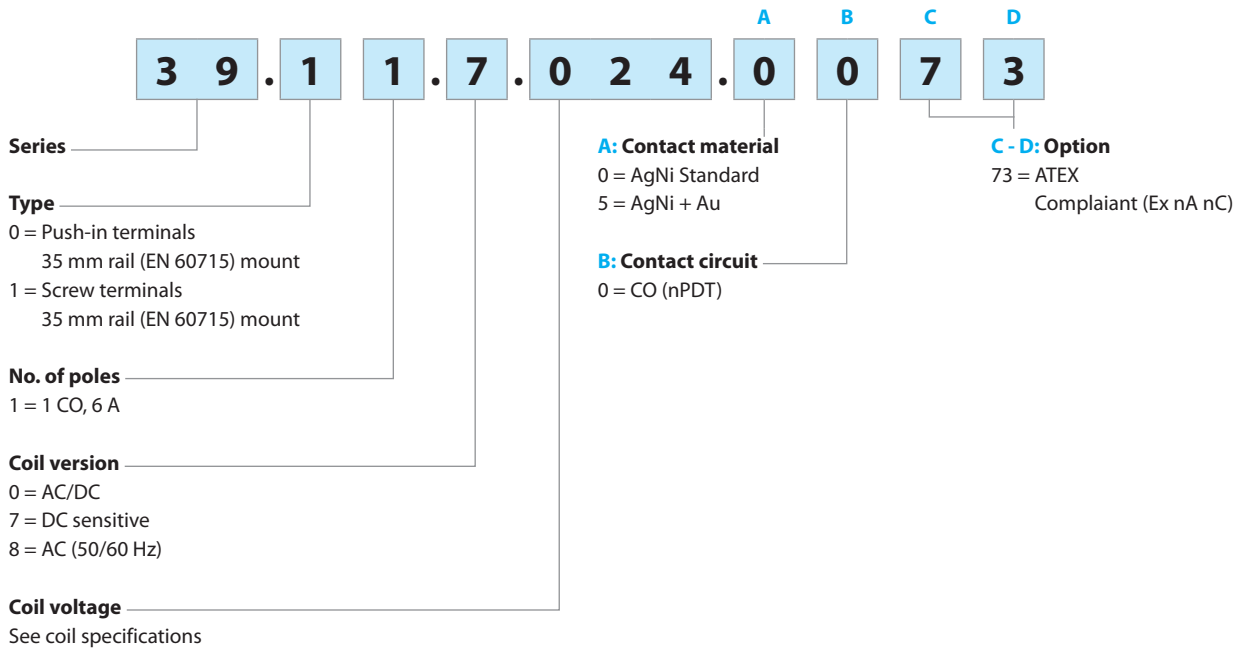

### Other data ATEX versions

| Max current @ 70 °C                   |                 | Single piece mount       | > 8 piece mount          |
|---------------------------------------|-----------------|--------------------------|--------------------------|
| Type 39.11/01                         | A               | 6                        | 5                        |
| Type 39.11/01 (110...125)V AC/DC only | A               | 6                        | 4                        |
| Terminals                             |                 | Screw terminals          | Push-in Terminals        |
| Wire strip length                     | mm              | 10                       | 8                        |
| Screw torque                          | Nm              | 0.5                      | —                        |
| Wire size                             |                 | solid and stranded cable | solid and stranded cable |
|                                       | mm <sup>2</sup> | 1 x 2.5                  | 1 x 2.5                  |
|                                       | AWG             | 1 x 14                   | 1 x 14                   |

### Markings - ATEX versions - ATEX, II 3G Ex nA nC IIC Gc

| MARKING                     |  |
|-----------------------------|--|
|                             | Specific marking of explosion protection   |
| <b>II</b>                   | Component for surface plant (different from mines)   |
| <b>3</b>                    | Category 3: normal level of protection   |
| <b>GAS</b>                  | <b>G</b><br>Explosive atmosphere due to presence of combustible gas vapour or mist   |
|                             | <b>Ex nA</b><br>Non-sparking equipment   |
|                             | <b>Ex nC</b><br>Sealed device (type of protection for category 3G)   |
|                             | <b>IIC</b><br>Gas group  |
|                             | <b>Gc</b><br>Equipment Protection Level  |
| <b>-40 °C ≤ Ta ≤ +70 °C</b> | Ambient temperature  |
| <b>EPT 15 ATEX 0194 U</b>   | EPT: laboratory which issues the CE type certificate<br>15: year of issue of certificate<br>0194: number of CE type certificate<br>U: ATEX component |

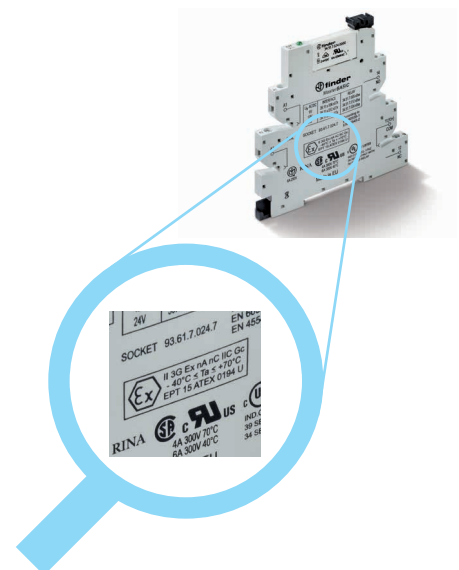

## Ordering information

Example: *MasterPLUS* 39 series screw terminal interface module, electromechanical relay output, 1 CO (SPDT), 24 V AC/DC coil.

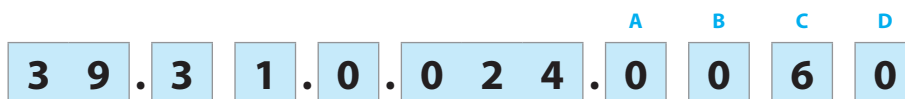

**B**

- Series**
- Type**
- 1 = *MasterBASIC*, screw terminal
  - 0 = *MasterBASIC*, push-in terminal
  - 3 = *MasterPLUS*, screw terminal, fuse-protectable output
  - 6 = *MasterPLUS*, push-in terminal, fuse-protectable output
  - 4 = *MasterINPUT*, screw terminal
  - 7 = *MasterINPUT*, push-in terminal
  - 2 = *MasterOUTPUT*, screw terminal
  - 5 = *MasterOUTPUT*, push-in terminal
  - 8 = *MasterTIMER* multifunction, screw terminal, fuse-protectable output
  - 9 = *MasterTIMER* multifunction, push-in terminal, fuse-protectable output

- No. of poles**
- 1 = 1 CO (only EMR, except 39.21/51, 1 NO)
  - 0 = 1 NO (only SSR)
- Coil version, EMR / Input version, SSR**
- 0 = AC (50/60 Hz)/DC
  - 3 = Leakage current suppression AC (50/60 Hz)
  - 7 = DC sensitive
  - 8 = AC (50/60 Hz)

**Coil voltage, EMR/ Input voltage, SSR**  
See page 18

- D: Special Version, EMR**  
0 = Standard
- C: Options, EMR**  
6 = Standard
- B: Contact circuit, EMR**  
0 = CO (except 39.21/51, 1 NO)
- A: Contact material, EMR**  
0 = AgNi Standard  
4 = AgSnO<sub>2</sub>  
5 = AgNi + Au
- ABCD: Output version, SSR**  
7048 = 0.1 A - 48 V DC  
8240 = 2 A - 230 V AC  
9024 = 2 A - 24 V DC

**EMR - Selecting features and options: only combinations in the same row are possible.**  
Preferred selections for best availability are shown in **bold**.

| Type     | Coil version                        | A                | B        | C        | D        |
|----------|-------------------------------------|------------------|----------|----------|----------|
| 39.11/01 | 0.006 - 0.012                       | <b>0</b> - 4 - 5 | <b>0</b> | <b>6</b> | <b>0</b> |
|          | <b>0.024</b> - 0.125 - <b>8.230</b> |                  |          |          |          |
| 39.31/61 | 0.006 - 0.012                       | <b>0</b> - 4 - 5 | <b>0</b> | <b>6</b> | <b>0</b> |
|          | <b>0.024</b> - 0.060                |                  |          |          |          |
|          | 0.125 - 0.240 - <b>8.230</b>        |                  |          |          |          |
|          | 7.125 - 7.220                       |                  |          |          |          |
| 39.41/71 | 0.006 - 0.012                       | 0 - 4 - 5        | <b>0</b> | <b>6</b> | <b>0</b> |
|          | <b>0.024</b> - 0.125                |                  |          |          |          |
|          | <b>8.230</b>                        |                  |          |          |          |
| 39.21/51 | 0.006 - 0.012                       | <b>0</b> - 4 - 5 | <b>0</b> | <b>6</b> | <b>0</b> |
|          | <b>0.024</b> - 0.125                |                  |          |          |          |
|          | <b>8.230</b>                        |                  |          |          |          |
| 39.81/91 | 0.012 - <b>0.024</b>                | <b>0</b>         | <b>0</b> | <b>6</b> | <b>0</b> |

**SSR - Selecting features and options: only combinations in the same row are possible.**  
Preferred selections for best availability are shown in **bold**.

| Type     | Input version                       | Output version, ABCD      |
|----------|-------------------------------------|---------------------------|
| 39.10/00 | 7.006 - 7.012                       | 7048 - 8240 - <b>9024</b> |
|          | <b>7.024</b> - 0.125 - <b>8.230</b> |                           |
| 39.30/60 | 7.006 - 7.012                       | 7048 - 8240 - <b>9024</b> |
|          | <b>7.024</b> - 7.060                |                           |
|          | 7.125 - 7.220                       |                           |
|          | 0.024 - 0.125 - 0.240               |                           |
|          | <b>8.230</b>                        |                           |
| 39.40/70 | 7.006 - 7.012                       | 7048 - 8240 - <b>9024</b> |
|          | <b>7.024</b> - 0.024 - 0.125        |                           |
|          | <b>8.230</b>                        |                           |
| 39.20/50 | 7.006 - 7.012                       | 7048 - 8240 - <b>9024</b> |
|          | <b>7.024</b> - 0.125                |                           |
| 39.80/90 | 0.012 - <b>0.024</b>                | 7048 - 8240 - <b>9024</b> |



## Technical data

| Insulation according to EN 61810-1      |                          |                     |     |
|---|--------------------------|---------------------|-----|
| Nominal voltage of supply system        | V AC                     | 230/400             |     |
| Rated insulation voltage                | V AC                     | 250                 | 400 |
| Pollution degree                        |                          | 3                   | 2   |
| Insulation between coil and contact set |                          |                     |     |
| Type of Insulation                      |                          | Reinforced          |     |
| Overvoltage category                    |                          | III                 |     |
| Rated impulse voltage                   | kV (1.2/50) $\mu$ s      | 6                   |     |
| Dielectric strength                     | V AC                     | 4000                |     |
| Insulation between open contacts (EMR)  |                          |                     |     |
| Type of disconnection                   |                          | Micro-disconnection |     |
| Dielectric strength                     | V AC/kV (1.2/50) $\mu$ s | 1000/1.5            |     |

| Conducted disturbance immunity  | $U_N \leq 60$ V | $U_N = 125$ V | $U_N = 230$ V |   |
|---|-----------------|---------------|---------------|---|
| Fast transients (burst 5/50 ns, 5 kHz) according to EN 61000-4-4 at supply terminals                    | kV              | 4             | 4             | 4 |
| Voltage pulses (surge 1.2/50 $\mu$ s) according to EN 61000-4-5 at supply terminals (differential mode) | kV              | 0.8           | 2             | 4 |

| Other data                                    |                         |       |                          |
|---|-------------------------|-------|--------------------------|
| Bounce time (EMR): NO/NC                      | ms                      | 1/6   |                          |
| Vibration resistance (EMR, 10...55 Hz): NO/NC | g                       | 10/15 |                          |
| Power lost to the environment                 | without contact current | W     | 0.2 (24 V) - 0.4 (230 V) |
|   | with rated current      | W     | 0.6 (24 V) - 0.9 (230 V) |

| Terminals         |                 |                          |                          |
|-------------------|-----------------|--------------------------|--------------------------|
|                   |                 | Screw terminal           | Push-in terminal         |
| Wire strip length | mm              | 10                       | 8                        |
| Screw torque      | Nm              | 0.5                      | —                        |
|                   |                 | Solid and stranded cable | Solid and stranded cable |
| Max. wire size    | mm <sup>2</sup> | 1 x 2.5 / 2 x 1.5        | 1 x 2.5                  |
|                   | AWG             | 1 x 14 / 2 x 16          | 1 x 14                   |
| Min. wire size    | mm <sup>2</sup> | 1 x 0.2                  | 1 x 0.2                  |
|                   | AWG             | 1 x 24                   | 1 x 24                   |

## Contact specification (EMR)

F 39 - Electrical life (AC) v contact current

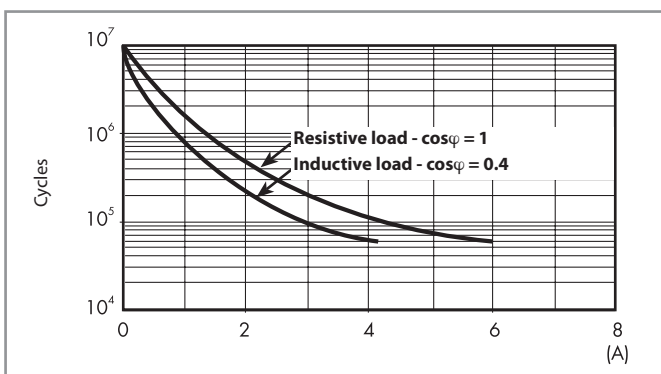

H 39 - Maximum DC1 breaking capacity

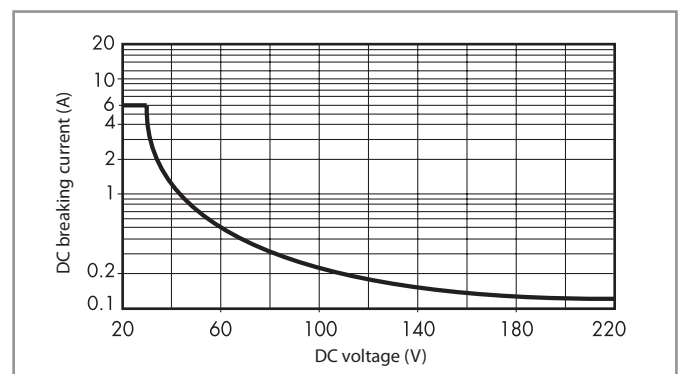

- When switching a resistive load (DC1) having voltage and current values under the curve, an electrical life of  $\geq 60 \cdot 10^3$  can be expected.
- In the case of DC13 loads, the connection of a diode in parallel with the load will permit a similar electrical life as for a DC1 load.  
Note: the release time for the load will be increased.

## Coil specifications - Electromechanical Relay

### Coil data DC, type 39.31/61

| Nominal voltage<br>$U_N$ | Coil code | Operating range |           | Must drop-out voltage<br>$U_r$ | Rated input current at $U_N$<br>$I_N$ | Rated power at $U_N$<br>at $U_N$ |
|--------------------------|-----------|-----------------|-----------|--------------------------------|---------------------------------------|----------------------------------|
|                          |           | $U_{min}$       | $U_{max}$ |                                |                                       |                                  |
| V                        |           | V               | V         | V                              | mA                                    | W                                |
| 125<br>(110...125)       | 7.125     | 88              | 138       | 12.5                           | 4.6                                   | 0.6                              |
| 220                      | 7.220     | 176             | 242       | 22                             | 3.0                                   | 0.6                              |

### Coil data AC/DC, type 39.11/21/31/41/01/51/61/71

| Nominal voltage<br>$U_N$         | Coil code | Operating range |           | Must drop-out voltage<br>$U_r$ | Rated input current at $U_N$<br>$I_N$ | Rated power at $U_N$<br>at $U_N$ |
|----------------------------------|-----------|-----------------|-----------|--------------------------------|---------------------------------------|----------------------------------|
|                                  |           | $U_{min}$       | $U_{max}$ |                                |                                       |                                  |
| V                                |           | V               | V         | V                              | mA                                    | VA/W                             |
| 6                                | 0.006     | 4.8             | 6.6       | 0.6                            | 35                                    | 0.2/0.2                          |
| 12                               | 0.012     | 9.6             | 13.2      | 1.5                            | 15                                    | 0.2/0.2                          |
| 24                               | 0.024     | 19.2            | 26.4      | 2.4                            | 11                                    | 0.25/0.25                        |
| 60 <sup>(1)</sup>                | 0.060     | 48              | 66        | 6.0                            | 5.7                                   | 0.35/0.35                        |
| 125<br>(110...125)               | 0.125     | 88              | 138       | 12.5                           | 5.6                                   | 0.7/0.7                          |
| 240<br>(24...240) <sup>(2)</sup> | 0.240     | 20.4            | 264       | 2.4                            | 19                                    | 1.5/0.3                          |

<sup>(1)</sup> 60 V AC/DC for type 39.31/61 only

<sup>(2)</sup> 24...240 V AC/DC for type 39.31/61 only

### Coil data AC, type 39.11/21/31/41/01/51/61/71

| Nominal voltage<br>$U_N$ | Coil code | Operating range |           | Must drop-out voltage<br>$U_r$ | Rated input current at $U_N$<br>$I_N$ | Rated power at $U_N$<br>at $U_N$ |
|--------------------------|-----------|-----------------|-----------|--------------------------------|---------------------------------------|----------------------------------|
|                          |           | $U_{min}$       | $U_{max}$ |                                |                                       |                                  |
| V                        |           | V               | V         | V                              | mA                                    | VA/W                             |
| 230<br>(230...240)       | 8.230     | 184             | 264       | 23                             | 4.3                                   | 1/0.4                            |

### Coil data leakage current suppression versions, type 39.31.3/61.3

| Nominal voltage<br>$U_N$ | Coil code | Operating range |           | Must drop-out voltage<br>$U_r$ | Rated input current at $U_N$<br>$I_N$ | Rated power at $U_N$<br>at $U_N$ |
|--------------------------|-----------|-----------------|-----------|--------------------------------|---------------------------------------|----------------------------------|
|                          |           | $U_{min}$       | $U_{max}$ |                                |                                       |                                  |
| V                        |           | V               | V         | V                              | mA                                    | VA/W                             |
| 125<br>(110...125)       | 3.125     | 88              | 138       | 44                             | 8.4                                   | 1.1/1                            |
| 230<br>(230...240)       | 3.230     | 184             | 264       | 72                             | 5.9                                   | 1.4/0.5                          |

The 39 Series interface modules (supply version 3) have built-in leakage current suppression to address industry concerns of the contacts not dropping-out when there is residual current in the circuit; at (110...125)V AC/DC and (230...240)V AC.

This problem can occur, for example, when connecting the interface modules to PLC's with triac outputs or when connecting via relatively long cables.

### Coil data AC/DC timer, type 39.81/91

| Nominal voltage<br>$U_N$ | Coil code | Operating range (AC/DC) |           | Must drop-out voltage<br>$U_r$ | Rated input current at $U_N$ |    | Rated power at $U_N$ |         |
|--------------------------|-----------|-------------------------|-----------|--------------------------------|------------------------------|----|----------------------|---------|
|                          |           | $U_{min}$               | $U_{max}$ |                                | DC                           | AC | DC                   | AC      |
| V                        |           | V                       | V         | V                              | mA                           | mA | W                    | VA/W    |
| 12                       | 0.012     | 9.6                     | 13.2      | 1.2                            | 15                           | 23 | 0.2                  | 0.3/0.2 |
| 24                       | 0.024     | 19.2                    | 26.4      | 2.4                            | 11                           | 19 | 0.25                 | 0.4/0.3 |

**Input specifications - Solid State Relay**

**Input data DC**, type 39.10/20/30/40/00/50/60/70

| Nominal voltage<br>$U_N$          | Input code | Operating range |           | Must drop-out voltage<br>$U_r$ | Rated input current at $U_N$ |      | Rated power at $U_N$ |
|-----------------------------------|------------|-----------------|-----------|--------------------------------|------------------------------|------|----------------------|
|                                   |            | $U_{min}$       | $U_{max}$ |                                | $I_N$                        |      |                      |
| V                                 |            | V               | V         | V                              | mA                           | W    |                      |
| 6                                 | 7.006      | 4.8             | 6.6       | 0.6                            | 7.5                          | 0.2  |                      |
| 12                                | 7.012      | 9.6             | 13.2      | 1.2                            | 20.7                         | 0.25 |                      |
| 24                                | 7.024      | 19.2            | 26.4      | 2.4                            | 10.5                         | 0.25 |                      |
| 60 <sup>(1)</sup>                 | 7.060      | 38              | 66        | 6.0                            | 6.4                          | 0.4  |                      |
| 125 <sup>(1)</sup><br>(110...125) | 7.125      | 88              | 138       | 12.5                           | 4.6                          | 0.6  |                      |
| 220 <sup>(1)</sup>                | 7.220      | 176             | 242       | 22                             | 3.0                          | 0.6  |                      |

<sup>(1)</sup> 60 V DC, 125 V DC and 220 V DC for type 39.30/60 only

**Input data AC/DC**, type 39.10/20/30/40/00/50/60/70

| Nominal voltage<br>$U_N$         | Input code | Operating range |           | Must drop-out voltage<br>$U_r$ | Rated input current at $U_N$ |         | Rated power at $U_N$ |
|----------------------------------|------------|-----------------|-----------|--------------------------------|------------------------------|---------|----------------------|
|                                  |            | $U_{min}$       | $U_{max}$ |                                | $I_N$                        |         |                      |
| V                                |            | V               | V         | V                              | mA                           | VA/W    |                      |
| 24 <sup>(2)</sup>                | 0.024      | 19.2            | 26.4      | 2.4                            | 17.5                         | 0.4/0.3 |                      |
| 125<br>(110...125)               | 0.125      | 88              | 138       | 12.5                           | 5.5                          | 0.7/0.7 |                      |
| 240<br>(24...240) <sup>(3)</sup> | 0.240      | 20.4            | 264       | 2.4                            | 17.5                         | 1.5/0.3 |                      |

<sup>(2)</sup> 24 V AC/DC for type 39.30/40/60/70 only

<sup>(3)</sup> 24...240 V AC/DC for type 39.30/60 only

**Input data AC**, type 39.10/20/30/40/00/50/60/70

| Nominal voltage<br>$U_N$ | Input code | Operating range |           | Must drop-out voltage<br>$U_r$ | Rated input current at $U_N$ |       | Rated power at $U_N$ |
|--------------------------|------------|-----------------|-----------|--------------------------------|------------------------------|-------|----------------------|
|                          |            | $U_{min}$       | $U_{max}$ |                                | $I_N$                        |       |                      |
| V                        |            | V               | V         | V                              | mA                           | VA/W  |                      |
| 230<br>(230...240)       | 8.230      | 184             | 264       | 23                             | 4.2                          | 1/0.4 |                      |

**Input data leakage current suppression versions**, type 39.30.3/60.3

| Nominal voltage<br>$U_N$ | Input code | Operating range |           | Must drop-out voltage<br>$U_r$ | Rated input current at $U_N$ |         | Rated power at $U_N$ |
|--------------------------|------------|-----------------|-----------|--------------------------------|------------------------------|---------|----------------------|
|                          |            | $U_{min}$       | $U_{max}$ |                                | $I_N$                        |         |                      |
| V                        |            | V               | V         | V                              | mA                           | VA/W    |                      |
| 125<br>(110...125)       | 3.125      | 88              | 138       | 44                             | 8.4                          | 1.1/1   |                      |
| 230<br>(230...240)       | 3.230      | 184             | 264       | 72                             | 5.9                          | 1.4/0.5 |                      |

The 39 Series interface modules (supply version 3) have built-in leakage current suppression to address industry concerns of the contacts not dropping-out when there is residual current in the circuit; at (110...125)V AC/DC and (230...240)V AC.

This problem can occur, for example, when connecting the interface modules to PLC's with triac outputs or when connecting via relatively long cables.

**Input data AC/DC timer**, type 39.80/90

| Nominal voltage<br>$U_N$ | Input code | Operating range (AC/DC) |           | Must drop-out voltage<br>$U_r$ | Rated input current at $U_N$ |    | Rated power at $U_N$ |         |
|--------------------------|------------|-------------------------|-----------|--------------------------------|------------------------------|----|----------------------|---------|
|                          |            | $U_{min}$               | $U_{max}$ |                                | DC                           | AC | DC                   | AC      |
| V                        |            | V                       | V         | V                              | mA                           | mA | W                    | VA/W    |
| 12                       | 0.012      | 9.6                     | 13.2      | 1.2                            | 15                           | 23 | 0.2                  | 0.3/0.2 |
| 24                       | 0.024      | 19.2                    | 26.4      | 2.4                            | 11                           | 19 | 0.25                 | 0.4/0.3 |

## Timer specifications

### EMC specifications

| Type of test  |                             | Reference standard |         |
|---|-----------------------------|--------------------|---------|
| Electrostatic discharge                                   | contact discharge           | EN 61000-4-2       | 4 kV    |
|   | air discharge               | EN 61000-4-2       | 8 kV    |
| Radio-frequency electromagnetic field                     | (80 ÷ 1000 MHz)             | EN 61000-4-3       | 10 V/m  |
|   | (1400 ÷ 2700 MHz)           | EN 61000-4-3       | 10 V/m  |
| Fast transients (burst) (5-50 ns, 5 and 100 kHz)          | on Supply terminals         | EN 61000-4-4       | 4 kV    |
|   | on control signal terminals | EN 61000-4-4       | 4 kV    |
| Surges (1.2/50 µs) on supply and control signal terminals | common mode                 | EN 61000-4-5       | 2 kV    |
|   | differential mode           | EN 61000-4-5       | 0.8 kV  |
| Radio-frequency common mode (0.15 ÷ 80 MHz)               | on Supply terminals         | EN 61000-4-6       | 10 V    |
|   | on control signal terminals | EN 61000-4-6       | 3 V     |
| Radiated and conducted emission                           |                             | EN 55022           | class B |

### Other data

|  |                         |       |     |
|--|-------------------------|-------|-----|
| Bounce time (EMR): NO/NC                     | ms                      | 1/6   |     |
| Vibration resistance (EMR, 10..55 Hz): NO/NC | g                       | 10/15 |     |
| Power lost to the environment                | without contact current | W     | 0.3 |
|  | with rated current      | W     | 0.8 |





### Terminals

|   |                 | Screw terminal           | Push-in terminal         |
|---|-----------------|--------------------------|--------------------------|
| Wire strip length   | mm              | 10                       | 8                        |
|  Screw torque | Nm              | 0.5                      | —                        |
|   |                 | Solid and stranded cable | Solid and stranded cable |
| Max. wire size  | mm <sup>2</sup> | 1 x 2.5 / 2 x 1.5        | 1 x 2.5                  |
|   | AWG             | 1 x 14 / 2 x 16          | 1 x 14                   |
| Min. wire size  | mm <sup>2</sup> | 1 x 0.2                  | 1 x 0.2                  |
|   | AWG             | 1 x 24                   | 1 x 24                   |

## Times scales



## Functions

| LED   | Supply voltage | NO contact/output                  |
|---|----------------|------------------------------------|
|  | OFF            | Open                               |
|  | ON             | Open                               |
|  | ON             | Open (timing to close in progress) |
|  | ON             | Closed                             |

Wiring diagram

U = Supply voltage

S = Signal switch

— = Output contact

Without control signal

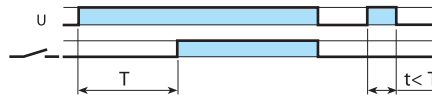
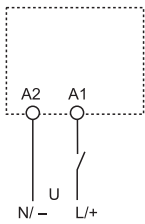

**(AI) On-delay**  
Apply power to timer. Output contacts transfer after preset time has elapsed. Reset occurs when power is removed.

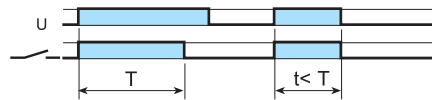

**(DI) Interval**  
Apply power to timer. Output contacts transfer immediately. After the preset time has elapsed, contacts reset.

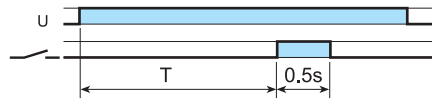

**(GI) Pulse (0.5 s) delayed**  
Apply power to timer. Output contacts transfer after preset time has elapsed. Reset occurs after a fixed time of 0.5 s.

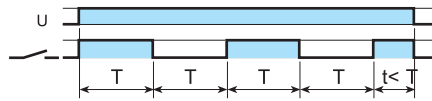

**(SW) Symmetrical flasher (starting pulse on)**  
Apply power to timer. Output contacts transfer immediately and cycle between ON and OFF for as long as power is applied. The ratio is 1:1 (time on = time off).

With control signal

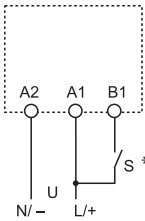

\* With DC supply, positive polarity has to be connected to B1, terminal (according to EN 60204-1).

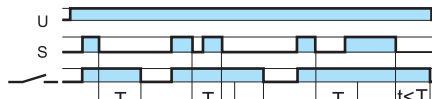

**(BE) Off-delay with control signal**  
Power is permanently applied to the timer. The output contacts transfer immediately on closure of the Signal Switch (S). Opening the Signal Switch initiates the preset delay, after which time the output contacts reset.

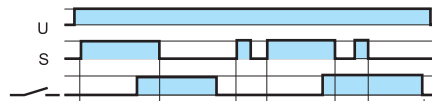

**(CE) On- and off-delay with control signal**  
Power is permanently applied to the timer. Closing the Signal Switch (S) initiates the preset delay, after which time the output contacts transfer. Opening the Signal switch initiates the same preset delay, after which time the output contacts reset.



**(DE) Interval with control signal on**  
Power is permanently applied to the timer. On momentary or maintained closure of Signal Switch (S), the output contacts transfer, and remain so for the duration of the preset delay, after which they reset.

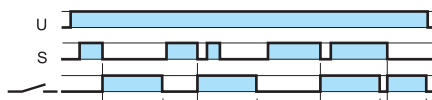

**(EE) Interval with control signal off**  
Power is permanently applied to the timer. On opening of the Signal Switch (S) the output contacts transfer, and remain so for the duration of the preset delay, after which they reset.

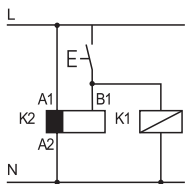

• Possible to control an external load, such as another relay coil or timer, connected to the control signal terminal B1.

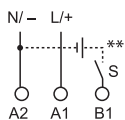

\*\* A voltage other than the supply voltage can be applied to the command Start (B1), example:  
A1 - A2 = 24 V AC  
B1 - A2 = 12 V DC

Outline drawings - Screw terminal sockets

B

39.10/39.20  
39.11/39.21  
Screw terminal

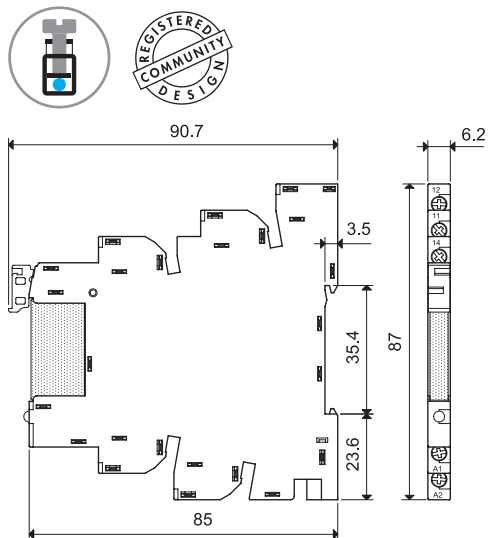

39.30/39.30.3  
39.31/39.31.3  
Screw terminal

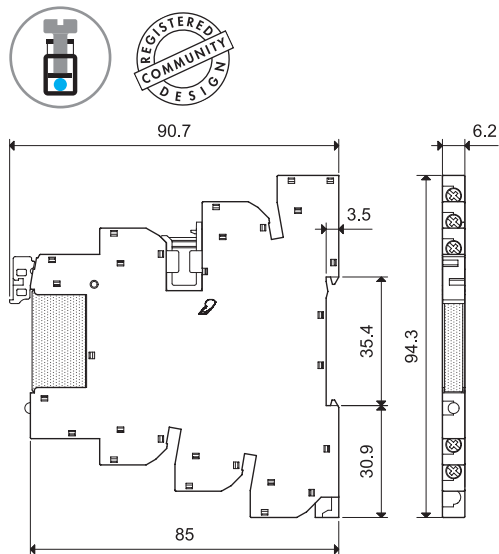

39.40  
39.41  
Screw terminal

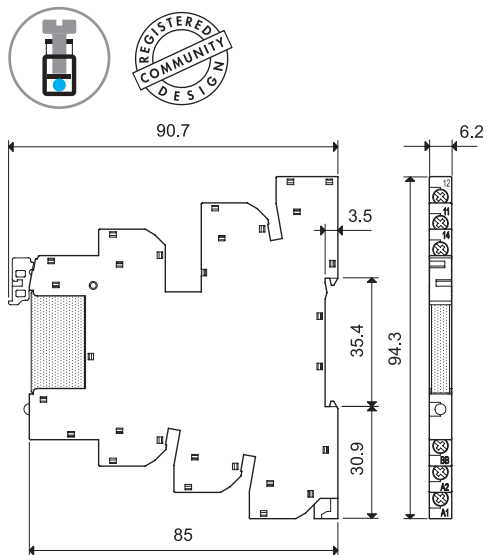

39.80  
39.81  
Screw terminal

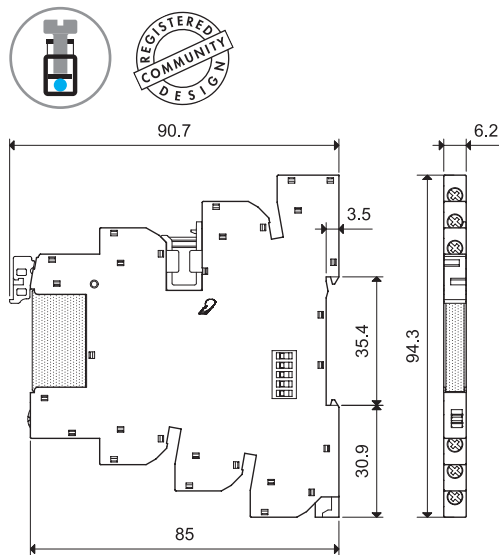

**Outline drawings - Push-in terminal sockets**

39.00/39.01  
39.50/39.51  
Push-in terminal

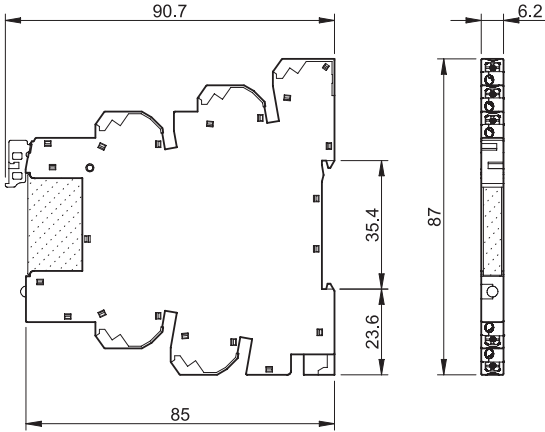

39.60/39.60.3  
39.61/39.61.3  
Push-in terminal

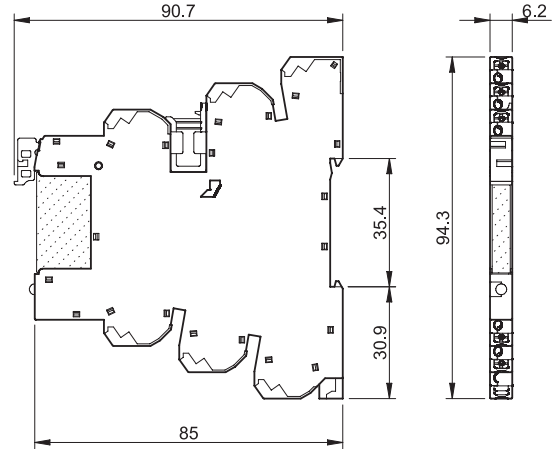

39.70  
39.71  
Push-in terminal

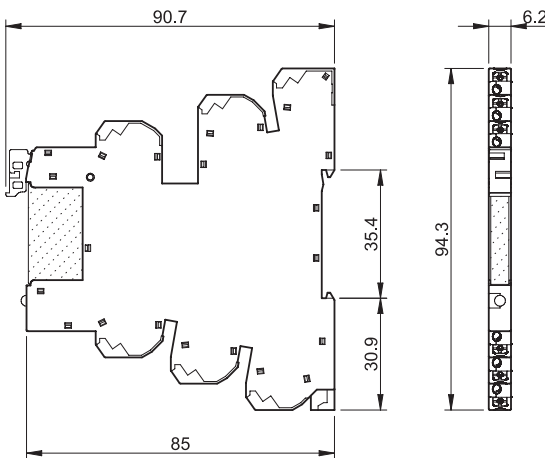

39.90  
39.91  
Push-in terminal

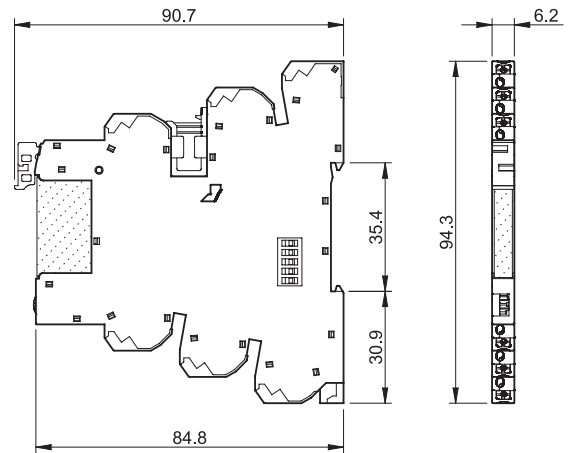

**Main features**

**Push-in terminals**

The push-in terminals permit the quick connection of solid wires or ferrules by their simple insertion into the terminal (A). It is possible to open the terminal to extract the wire by first pushing down on the push-button using a screwdriver (C). For stranded cable it is necessary first to open the terminal using the push button, both for the extraction (C) and insertion (B). It is possible at any time to check the connection via the test aperture, using a 2 mm diameter test probe (D).

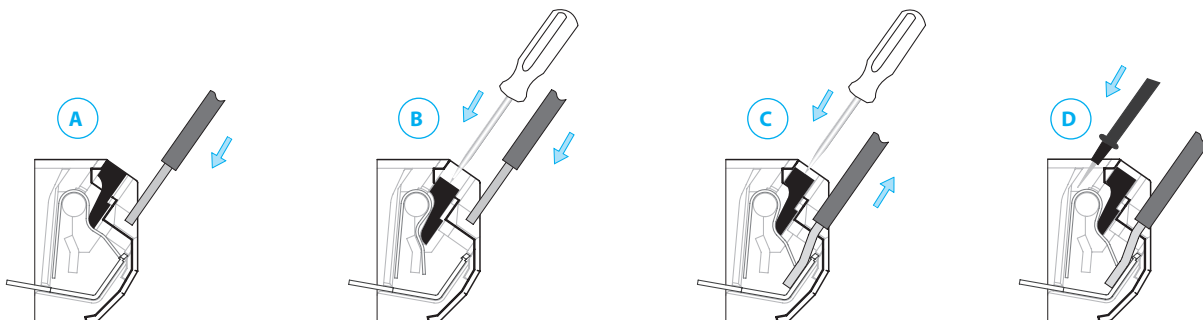

## Electromechanical Relay (1 Pole 6 A) & Screw Socket Combinations

| Interface Module Code              | Coil voltage       | Relay            | Socket      |
|------------------------------------|--------------------|------------------|-------------|
| <b>MasterBASIC</b>                 |                    |                  |             |
| 39.11.0.006.0060                   | 6 V AC/DC          | 34.51.7.005.0010 | 93.61.7.024 |
| 39.11.0.012.0060                   | 12 V AC/DC         | 34.51.7.012.0010 | 93.61.7.024 |
| 39.11.0.024.0060                   | 24 V AC/DC         | 34.51.7.024.0010 | 93.61.7.024 |
| 39.11.0.125.0060                   | (110...125)V AC/DC | 34.51.7.060.0010 | 93.61.0.125 |
| 39.11.8.230.0060                   | (230...240)V AC    | 34.51.7.060.0010 | 93.61.8.230 |
| <b>MasterPLUS</b>                  |                    |                  |             |
| 39.31.0.006.0060                   | 6 V AC/DC          | 34.51.7.005.0010 | 93.63.7.024 |
| 39.31.0.012.0060                   | 12 V AC/DC         | 34.51.7.012.0010 | 93.63.7.024 |
| 39.31.0.024.0060                   | 24 V AC/DC         | 34.51.7.024.0010 | 93.63.7.024 |
| 39.31.0.060.0060                   | 60 V AC/DC         | 34.51.7.060.0010 | 93.63.7.060 |
| 39.31.0.125.0060                   | (110...125)V AC/DC | 34.51.7.060.0010 | 93.63.0.125 |
| 39.31.0.240.0060                   | (24...240)V AC/DC  | 34.51.7.024.0010 | 93.63.0.240 |
| 39.31.8.230.0060                   | (230...240)V AC    | 34.51.7.060.0010 | 93.63.8.230 |
| 39.31.7.125.0060                   | (110...125)V DC    | 34.51.7.060.0010 | 93.63.7.125 |
| 39.31.7.220.0060                   | 220 V DC           | 34.51.7.060.0010 | 93.63.7.220 |
| 39.31.3.125.0060                   | (110...125)V AC/DC | 34.51.7.060.0010 | 93.63.3.125 |
| 39.31.3.230.0060                   | (230...240)V AC    | 34.51.7.060.0010 | 93.63.3.230 |
| <b>MasterINPUT</b>                 |                    |                  |             |
| 39.41.0.006.5060                   | 6 V AC/DC          | 34.51.7.005.5010 | 93.64.7.024 |
| 39.41.0.012.5060                   | 12 V AC/DC         | 34.51.7.012.5010 | 93.64.7.024 |
| 39.41.0.024.5060                   | 24 V AC/DC         | 34.51.7.024.5010 | 93.64.7.024 |
| 39.41.0.125.5060                   | (110...125)V AC/DC | 34.51.7.060.5010 | 93.64.0.125 |
| 39.41.8.230.5060                   | (230...240)V AC    | 34.51.7.060.5010 | 93.64.8.230 |
| <b>MasterOUTPUT 1 NO, 6 A only</b> |                    |                  |             |
| 39.21.0.006.0060                   | 6 V AC/DC          | 34.51.7.005.0010 | 93.62.7.024 |
| 39.21.0.012.0060                   | 12 V AC/DC         | 34.51.7.012.0010 | 93.62.7.024 |
| 39.21.0.024.0060                   | 24 V AC/DC         | 34.51.7.024.0010 | 93.62.7.024 |
| 39.21.0.125.0060                   | (110...125)V AC/DC | 34.51.7.060.0010 | 93.62.0.125 |
| 39.21.8.230.0060                   | (230...240)V AC    | 34.51.7.060.0010 | 93.62.8.230 |
| <b>MasterTIMER</b>                 |                    |                  |             |
| 39.81.0.012.0060                   | 12 V AC/DC         | 34.51.7.012.0010 | 93.68.0.024 |
| 39.81.0.024.0060                   | 24 V AC/DC         | 34.51.7.024.0010 | 93.68.0.024 |

## Solid State Relay (1 Pole 0.1 or 2 A) & Screw Socket Combinations

| Interface Module Code | Input voltage      | Relay            | Socket      |
|-----------------------|--------------------|------------------|-------------|
| <b>MasterBASIC</b>    |                    |                  |             |
| 39.10.7.006.xxxx      | 6 V DC             | 34.81.7.005.xxxx | 93.61.7.024 |
| 39.10.7.012.xxxx      | 12 V DC            | 34.81.7.012.xxxx | 93.61.7.024 |
| 39.10.7.024.xxxx      | 24 V DC            | 34.81.7.024.xxxx | 93.61.7.024 |
| 39.10.0.125.xxxx      | (110...125)V AC/DC | 34.81.7.060.xxxx | 93.61.0.125 |
| 39.10.8.230.xxxx      | (230...240)V AC    | 34.81.7.060.xxxx | 93.61.8.230 |
| <b>MasterPLUS</b>     |                    |                  |             |
| 39.30.7.006.xxxx      | 6 V DC             | 34.81.7.005.xxxx | 93.63.7.024 |
| 39.30.7.012.xxxx      | 12 V DC            | 34.81.7.012.xxxx | 93.63.7.024 |
| 39.30.7.024.xxxx      | 24 V DC            | 34.81.7.024.xxxx | 93.63.7.024 |
| 39.30.7.060.xxxx      | 60 V DC            | 34.81.7.060.xxxx | 93.63.7.060 |
| 39.30.7.125.xxxx      | (110...125)V DC    | 34.81.7.060.xxxx | 93.63.7.125 |
| 39.30.7.220.xxxx      | 220 V DC           | 34.81.7.060.xxxx | 93.63.7.220 |
| 39.30.0.024.xxxx      | 24 V AC/DC         | 34.81.7.024.xxxx | 93.63.0.024 |
| 39.30.0.125.xxxx      | (110...125)V AC/DC | 34.81.7.060.xxxx | 93.63.0.125 |
| 39.30.0.240.xxxx      | (24...240)V AC/DC  | 34.81.7.024.xxxx | 93.63.0.240 |
| 39.30.8.230.xxxx      | (230...240)V AC    | 34.81.7.060.xxxx | 93.63.8.230 |
| 39.30.3.125.xxxx      | (110...125)V AC/DC | 34.81.7.060.xxxx | 93.63.3.125 |
| 39.30.3.230.xxxx      | (230...240)V AC    | 34.81.7.060.xxxx | 93.63.3.230 |
| <b>MasterINPUT</b>    |                    |                  |             |
| 39.40.7.006.xxxx      | 6 V DC             | 34.81.7.005.xxxx | 93.64.7.024 |
| 39.40.7.012.xxxx      | 12 V DC            | 34.81.7.012.xxxx | 93.64.7.024 |
| 39.40.7.024.xxxx      | 24 V DC            | 34.81.7.024.xxxx | 93.64.7.024 |
| 39.40.0.024.xxxx      | 24 V AC/DC         | 34.81.7.024.xxxx | 93.64.0.024 |
| 39.40.0.125.xxxx      | (110...125)V AC/DC | 34.81.7.060.xxxx | 93.64.0.125 |
| 39.40.8.230.xxxx      | (230...240)V AC    | 34.81.7.060.xxxx | 93.64.8.230 |
| <b>MasterOUTPUT</b>   |                    |                  |             |
| 39.20.7.006.xxxx      | 6 V DC             | 34.81.7.005.xxxx | 93.62.7.024 |
| 39.20.7.012.xxxx      | 12 V DC            | 34.81.7.012.xxxx | 93.62.7.024 |
| 39.20.7.024.xxxx      | 24 V DC            | 34.81.7.024.xxxx | 93.62.7.024 |
| 39.20.0.125.xxxx      | (110...125)V AC/DC | 34.81.7.060.xxxx | 93.62.0.125 |
| 39.20.8.230.xxxx      | (230...240)V AC    | 34.81.7.060.xxxx | 93.62.8.230 |
| <b>MasterTIMER</b>    |                    |                  |             |
| 39.80.0.012.xxxx      | 12 V AC/DC         | 34.81.7.012.xxxx | 93.68.0.024 |
| 39.80.0.024.xxxx      | 24 V AC/DC         | 34.81.7.024.xxxx | 93.68.0.024 |

Example: .xxxx  
.9024  
.7048  
.8240



## Electromechanical Relay (1 Pole 6 A) & Push-in Socket Combinations

| Interface Module Code              | Coil voltage       | Relay            | Socket      |
|------------------------------------|--------------------|------------------|-------------|
| <b>MasterBASIC</b>                 |                    |                  |             |
| 39.01.0.006.0060                   | 6 V AC/DC          | 34.51.7.005.0010 | 93.60.7.024 |
| 39.01.0.012.0060                   | 12 V AC/DC         | 34.51.7.012.0010 | 93.60.7.024 |
| 39.01.0.024.0060                   | 24 V AC/DC         | 34.51.7.024.0010 | 93.60.7.024 |
| 39.01.0.125.0060                   | (110...125)V AC/DC | 34.51.7.060.0010 | 93.60.0.125 |
| 39.01.8.230.0060                   | (230...240)V AC    | 34.51.7.060.0010 | 93.60.8.230 |
| <b>MasterPLUS</b>                  |                    |                  |             |
| 39.61.0.006.0060                   | 6 V AC/DC          | 34.51.7.005.0010 | 93.66.7.024 |
| 39.61.0.012.0060                   | 12 V AC/DC         | 34.51.7.012.0010 | 93.66.7.024 |
| 39.61.0.024.0060                   | 24 V AC/DC         | 34.51.7.024.0010 | 93.66.7.024 |
| 39.61.0.060.0060                   | 60 V AC/DC         | 34.51.7.060.0010 | 93.66.7.060 |
| 39.61.0.125.0060                   | (110...125)V AC/DC | 34.51.7.060.0010 | 93.66.0.125 |
| 39.61.0.240.0060                   | (24...240)V AC/DC  | 34.51.7.024.0010 | 93.66.0.240 |
| 39.61.8.230.0060                   | (230...240)V AC    | 34.51.7.060.0010 | 93.66.8.230 |
| 39.61.7.125.0060                   | (110...125)V DC    | 34.51.7.060.0010 | 93.66.7.125 |
| 39.61.7.220.0060                   | 220 V DC           | 34.51.7.060.0010 | 93.66.7.220 |
| 39.61.3.125.0060                   | (110...125)V AC/DC | 34.51.7.060.0010 | 93.66.3.125 |
| 39.61.3.230.0060                   | (230...240)V AC    | 34.51.7.060.0010 | 93.66.3.230 |
| <b>MasterINPUT</b>                 |                    |                  |             |
| 39.71.0.006.5060                   | 6 V AC/DC          | 34.51.7.005.5010 | 93.67.7.024 |
| 39.71.0.012.5060                   | 12 V AC/DC         | 34.51.7.012.5010 | 93.67.7.024 |
| 39.71.0.024.5060                   | 24 V AC/DC         | 34.51.7.024.5010 | 93.67.7.024 |
| 39.71.0.125.5060                   | (110...125)V AC/DC | 34.51.7.060.5010 | 93.67.0.125 |
| 39.71.8.230.5060                   | (230...240)V AC    | 34.51.7.060.5010 | 93.67.8.230 |
| <b>MasterOUTPUT 1 NO, 6 A only</b> |                    |                  |             |
| 39.51.0.006.0060                   | 6 V AC/DC          | 34.51.7.005.0010 | 93.65.7.024 |
| 39.51.0.012.0060                   | 12 V AC/DC         | 34.51.7.012.0010 | 93.65.7.024 |
| 39.51.0.024.0060                   | 24 V AC/DC         | 34.51.7.024.0010 | 93.65.7.024 |
| 39.51.0.125.0060                   | (110...125)V AC/DC | 34.51.7.060.0010 | 93.65.0.125 |
| 39.51.8.230.0060                   | (230...240)V AC    | 34.51.7.060.0010 | 93.65.8.230 |
| <b>MasterTIMER</b>                 |                    |                  |             |
| 39.91.0.012.0060                   | 12 V AC/DC         | 34.51.7.012.0010 | 93.69.0.024 |
| 39.91.0.024.0060                   | 24 V AC/DC         | 34.51.7.024.0010 | 93.69.0.024 |

## Solid State Relay (1 Pole 0.1 or 2 A) & Push-in Socket Combinations

| Interface Module Code | Input voltage      | Relay            | Socket      |
|-----------------------|--------------------|------------------|-------------|
| <b>MasterBASIC</b>    |                    |                  |             |
| 39.00.7.006.xxxx      | 6 V DC             | 34.81.7.005.xxxx | 93.60.7.024 |
| 39.00.7.012.xxxx      | 12 V DC            | 34.81.7.012.xxxx | 93.60.7.024 |
| 39.00.7.024.xxxx      | 24 V DC            | 34.81.7.024.xxxx | 93.60.7.024 |
| 39.00.0.125.xxxx      | (110...125)V AC/DC | 34.81.7.060.xxxx | 93.60.0.125 |
| 39.00.8.230.xxxx      | (230...240)V AC    | 34.81.7.060.xxxx | 93.60.8.230 |
| <b>MasterPLUS</b>     |                    |                  |             |
| 39.60.7.006.xxxx      | 6 V DC             | 34.81.7.005.xxxx | 93.66.7.024 |
| 39.60.7.012.xxxx      | 12 V DC            | 34.81.7.012.xxxx | 93.66.7.024 |
| 39.60.7.024.xxxx      | 24 V DC            | 34.81.7.024.xxxx | 93.66.7.024 |
| 39.60.7.060.xxxx      | 60 V DC            | 34.81.7.060.xxxx | 93.66.7.060 |
| 39.60.7.125.xxxx      | (110...125)V DC    | 34.81.7.060.xxxx | 93.66.7.125 |
| 39.60.7.220.xxxx      | 220 V DC           | 34.81.7.060.xxxx | 93.66.7.220 |
| 39.60.0.024.xxxx      | 24 V AC/DC         | 34.81.7.024.xxxx | 93.66.0.024 |
| 39.60.0.125.xxxx      | (110...125)V AC/DC | 34.81.7.060.xxxx | 93.66.0.125 |
| 39.60.0.240.xxxx      | (24...240)V AC/DC  | 34.81.7.024.xxxx | 93.66.0.240 |
| 39.60.8.230.xxxx      | (230...240)V AC    | 34.81.7.060.xxxx | 93.66.8.230 |
| 39.60.3.125.xxxx      | (110...125)V AC/DC | 34.81.7.060.xxxx | 93.66.3.125 |
| 39.60.3.230.xxxx      | (230...240)V AC    | 34.81.7.060.xxxx | 93.66.3.230 |
| <b>MasterINPUT</b>    |                    |                  |             |
| 39.70.7.006.xxxx      | 6 V DC             | 34.81.7.005.xxxx | 93.67.7.024 |
| 39.70.7.012.xxxx      | 12 V DC            | 34.81.7.012.xxxx | 93.67.7.024 |
| 39.70.7.024.xxxx      | 24 V DC            | 34.81.7.024.xxxx | 93.67.7.024 |
| 39.70.0.024.xxxx      | 24 V AC/DC         | 34.81.7.024.xxxx | 93.67.0.024 |
| 39.70.0.125.xxxx      | (110...125)V AC/DC | 34.81.7.060.xxxx | 93.67.0.125 |
| 39.70.8.230.xxxx      | (230...240)V AC    | 34.81.7.060.xxxx | 93.67.8.230 |
| <b>MasterOUTPUT</b>   |                    |                  |             |
| 39.50.7.006.xxxx      | 6 V DC             | 34.81.7.005.xxxx | 93.65.7.024 |
| 39.50.7.012.xxxx      | 12 V DC            | 34.81.7.012.xxxx | 93.65.7.024 |
| 39.50.7.024.xxxx      | 24 V DC            | 34.81.7.024.xxxx | 93.65.7.024 |
| 39.50.0.125.xxxx      | (110...125)V AC/DC | 34.81.7.060.xxxx | 93.65.0.125 |
| 39.50.8.230.xxxx      | (230...240)V AC    | 34.81.7.060.xxxx | 93.65.8.230 |
| <b>MasterTIMER</b>    |                    |                  |             |
| 39.90.0.012.xxxx      | 12 V AC/DC         | 34.81.7.012.xxxx | 93.69.0.024 |
| 39.90.0.024.xxxx      | 24 V AC/DC         | 34.81.7.024.xxxx | 93.69.0.024 |

### MasterBASIC ATEX version, Screw Socket Combinations

| Interface Module Code   | Coil voltage       | Relay            | Socket        |
|-------------------------|--------------------|------------------|---------------|
| <i>MasterBASIC ATEX</i> |                    |                  |               |
| 39.11.0.006.0073        | 6 V AC/DC          | 34.51.7.005.0000 | 93.61.0.024.7 |
| 39.11.0.012.0073        | 12 V AC/DC         | 34.51.7.012.0000 | 93.61.0.024.7 |
| 39.11.0.024.0073        | 24 V AC/DC         | 34.51.7.024.0000 | 93.61.0.024.7 |
| 39.11.0.125.0073        | (110...125)V AC/DC | 34.51.7.060.0000 | 93.61.0.125.7 |
| 39.11.0.240.0073        | (24...240)V AC/DC  | 34.51.7.024.0000 | 93.61.0.240.7 |
| 39.11.8.230.0073        | (230...240)V AC    | 34.51.7.060.0000 | 93.61.8.230.7 |
| 39.11.7.006.0073        | 6 V DC             | 34.51.7.005.0000 | 93.61.7.024.7 |
| 39.11.7.012.0073        | 12 V DC            | 34.51.7.012.0000 | 93.61.7.024.7 |
| 39.11.7.024.0073        | 24 V DC            | 34.51.7.024.0000 | 93.61.7.024.7 |

### MasterBASIC ATEX version, Push-in Socket Combinations

| Interface Module Code   | Input voltage      | Relay            | Socket        |
|-------------------------|--------------------|------------------|---------------|
| <i>MasterBASIC ATEX</i> |                    |                  |               |
| 39.01.0.006.0073        | 6 V AC/DC          | 34.51.7.005.0000 | 93.60.0.024.7 |
| 39.01.0.012.0073        | 12 V AC/DC         | 34.51.7.012.0000 | 93.60.0.024.7 |
| 39.01.0.024.0073        | 24 V AC/DC         | 34.51.7.024.0000 | 93.60.0.024.7 |
| 39.01.0.125.0073        | (110...125)V AC/DC | 34.51.7.060.0000 | 93.60.0.125.7 |
| 39.01.0.240.0073        | (24...240)V AC/DC  | 34.51.7.024.0000 | 93.60.0.240.7 |
| 39.01.8.230.0073        | (230...240)V AC    | 34.51.7.060.0000 | 93.60.8.230.7 |
| 39.01.7.006.0073        | 6 V DC             | 34.51.7.005.0000 | 93.60.7.024.7 |
| 39.01.7.012.0073        | 12 V DC            | 34.51.7.012.0000 | 93.60.7.024.7 |
| 39.01.7.024.0073        | 24 V DC            | 34.51.7.024.0000 | 93.60.7.024.7 |

Accessories

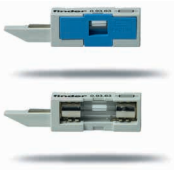

093.63

Approvals  
(according to type):



093.63.0.024  
093.63.8.230

|  |        |              |              |
|--|--------|--------------|--------------|
| <b>Output fuse module for 39.31/30/81/80/61/60/91/90 types</b> | 093.63 | 093.63.0.024 | 093.63.8.230 |
|--|--------|--------------|--------------|

- For 5 x 20 mm fuses up to 6 A, 250 V
- Easy visibility of the fuse condition through the window
- Type 093.63.0.024 - (6...24)V AC/DC
- Type 093.63.8.230 - (110...240)V AC
- Quick connection to socket

Notes

**Safety:** Because the output circuit can be reinstated (point 3 below), even with the fuse removed, it is important not to consider the removal of the fuse as a "safety disconnect". Always isolate elsewhere before working on the circuit.

**UL:** According to UL508A, the fuse module cannot be installed in power circuits (in which it is mandatory that a fuse certified according to UL category JDDZ be fitted). However, where the MasterInterface is connected as an output interface to a PLC no such restrictions apply, and the fuse module can be usefully employed.

Type 093.63

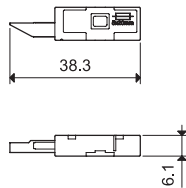

Type 093.63.0.024 / 093.63.8.230

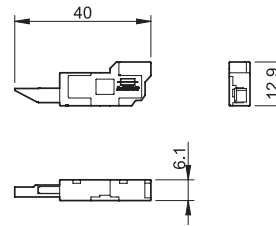

Multi-state fuse module

0. As delivered, the socket comes without a fuse module. However, the absent fuse is internally replaced with an electrical link - which allows the interface relay to be used without a fuse module. In this state, the peg/indicator is visually hidden and the connection is protected by a special cap.

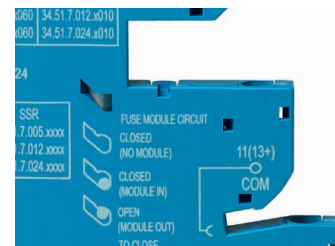
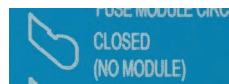

1. With fuse module inserted after removing the cap, the fuse is positioned electrically in series with the common output terminal of the interface module (11 for EMR versions, 13+ for SSR versions, 15 for EMR timer, 15+ for SSR timer). This state is indicated by the peg/indicator.

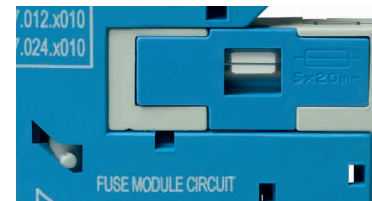
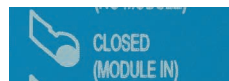

2. If the fuse module is extracted (for example; because the fuse element has blown) the output circuit will be locked open, as this will generally be the "safe option". This state is indicated by the peg/indicator.

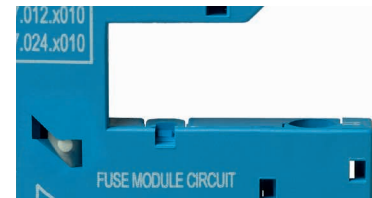

3. In order to reinstate the output circuit it is necessary to either re-insert the fuse module (complete with functional fuse), or alternatively, return the peg/indicator to position 0 by gently applying pressure in the direction of the arrow.

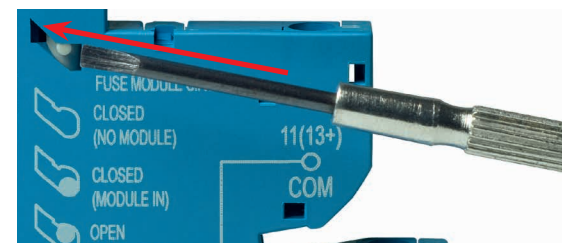
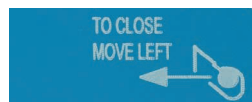

Accessories



093.16



093.16.0



093.16.1

Approvals  
(according to type):



|  |               |                  |                |
|--|---------------|------------------|----------------|
| <b>16-way jumper link</b>                        | 093.16 (blue) | 093.16.0 (black) | 093.16.1 (red) |
| Rated values                                     | 6 A - 250 V   |                  |                |
| Possibility of multiple connection, side by side |               |                  |                |

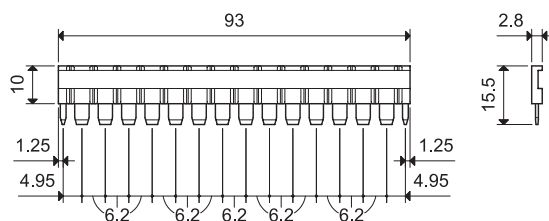

**Dual-purpose plastic separator (1.8 mm or 6.2 mm separation)** 093.60

1. By breaking off the protruding ribs (by hand), the separator becomes only 1.8 mm thick; useful for the visual separation of different groups of interfaces, or necessary for the protective separation of different voltages of neighbouring interfaces, or for the protection of cut ends of jumper links.



093.60

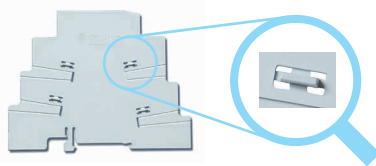

2. Leaving the ribs in place provides 6.2 mm separation. Simply cutting (with scissors) the relevant segment(s) permits the interconnection across the separator of 2 different groups of interface relays, using the standard jumper link.

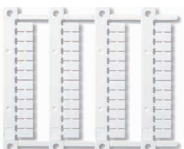
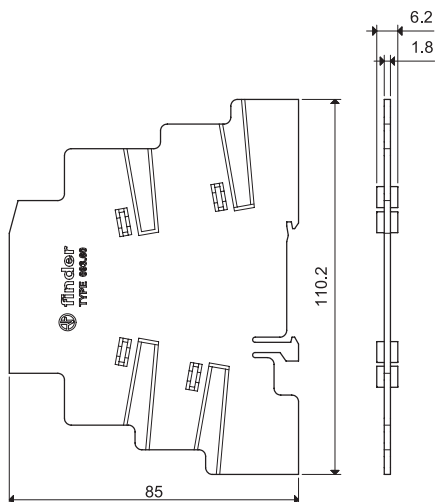

060.48



**Sheet of marker tags (CEMBRE'S Thermal transfer printers)** ,48 tags, 6 x 12 mm 060.48

Accessories



|  |                 |             |
|--|-----------------|-------------|
| <b>Terminal doubler</b> (for Push-in sockets only) |                 | 093.62      |
| Total load   |                 | 6 A - 300 V |
| Max. wire size                                     | mm <sup>2</sup> | 2 x 1.5     |
|  | AWG             | 2 x 16      |



**093.68.14.1**  
Approvals  
(according to type):



|   |             |
|---|-------------|
| <b>MasterADAPTER</b>  | 093.68.14.1 |
| The <b>MasterADAPTER</b> permits the easy connection of A1/A2 terminals of up to <b>MasterINTERFACE</b> modules to PLC outputs via a 14-Pole ribbon cable, plus simple 2-wire power supply connection ATEX Version. |             |

|                                   |                            |
|-----------------------------------|----------------------------|
| <b>Technical data</b>             |                            |
| Rated current (per signal path)   | A 1                        |
| Minimum required supply power     | W 3                        |
| Nominal voltage (U <sub>N</sub> ) | V DC 24                    |
| Operating range                   | (0.8...1.1)U <sub>N</sub>  |
| Control logic                     | Positive switching (to A1) |
| Power supply status indication    | Green LED                  |
| Ambient temperature range         | °C -40...+70               |

|   |                                    |
|---|------------------------------------|
| <b>Terminals for 24 V control logic</b> |                                    |
| Type of connector                       | 14 pole, according to IEC 60603-13 |
| ATEX version                            | II 3G Ex nA IIC Gc                 |

|  |               |                                   |
|--|---------------|-----------------------------------|
| <b>Terminals for 24 V power supply</b> |               |                                   |
| Wire strip length                      | mm 9.5        |                                   |
| Screw torque                           | Nm 0.5        |                                   |
| Max. wire size                         | solid wire    | mm <sup>2</sup> 1 x 4 / 2 x 1.5   |
|  |               | AWG 1 x 12 / 2 x 16               |
|  | stranded wire | mm <sup>2</sup> 1 x 2.5 / 2 x 1.5 |
|  |               | AWG 1 x 14 / 2 x 16               |

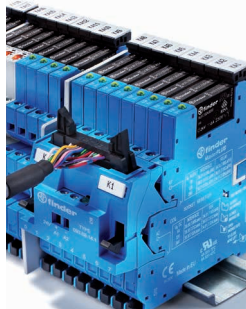

Connected **MasterADAPTER**

Wiring diagram

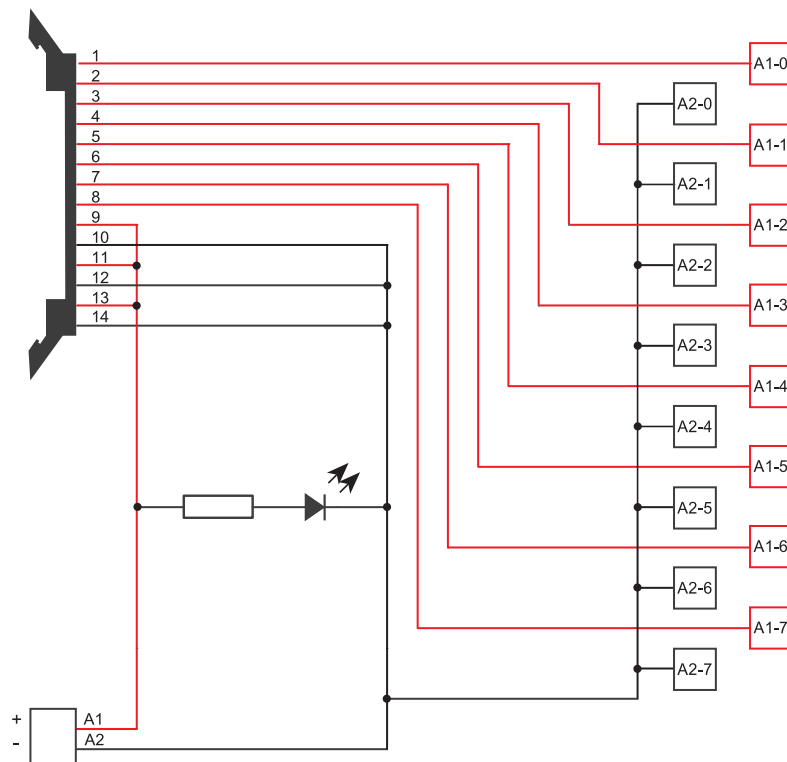



## X-ON Electronics

Largest Supplier of Electrical and Electronic Components

*Click to view similar products for [finder manufacturer](#):*

Other Similar products are found below :

[72.01.8.024.0000](#) [72.01.8.240.0000](#) [14.81.8.230.0000](#) [20.23.8.012.4000](#) [22.22.9.012.4000](#) [22.22.9.048.4000](#) [22.34.0.024.4340](#)  
[22.34.0.024.4720](#) [22.64.0.230.4310](#) [20.21.8.024.4000](#) [20.22.8.024.4000](#) [20.28.8.024.4000](#) [22.22.8.024.4000](#) [22.32.0.230.4440](#)  
[26.06.8.024.0000](#) [40.52.8.006.0000](#) [10.42.8.230.0000](#) [11.42.8.230.0000](#) [62.83.8.400.4600](#) [72.01.9.024.0000](#) [88.02.0.230.0002](#) [96.04SMA](#)  
[55.12.8.024.0000](#) [55.33.8.230.0000](#) [56.34.9.024.0000T](#) [96.14SMA](#) [39.11.0.006.0060](#) [55.14.8.024 0000](#) [40.31.8.240.0000](#) [62.82.8.230.0040](#)  
[72.11.8.024.0000](#) [71.51.8.230.1021](#) [4CP281100060SPA](#) [18.21.8.230.0300](#) [62.23.9.012.0300](#) [12.11.8.230.1000](#) [22.64.0.230.4710](#)  
[26.08.8.012.0000](#) [20.21.8.012.4000](#) [20.23.9.110.4000](#) [20.26.8.230.4000](#) [22.34.0.230.4340](#) [22.34.0.230.4620](#) [22.34.0.230.4720](#)  
[22.44.0.230.4710](#) [10.61.8.230.0000](#) [55.14.9.012.0000](#) [48.31.7.024.0050SPA](#) [22.34.0.012.4320](#) [22.32.0.048.4320](#)