

# Step relays 10 A



Lighting control  
in corridors (for  
hotels, offices  
and hospitals)



Bedroom  
light control



Living room  
light control



27  
SERIES



1 or 2 Pole electromechanical step relay, for electrically common coil and contact circuits

27.0x - Connect up to 24 illuminated push buttons with the addition of module 027.00

27.2x - Connect up to 15 illuminated push buttons (without additional module) - incorporates coil power limiter to permit continuous coil energisation

- Choice of 3 switching sequences
- Screw terminal connections
- AC coil
- Panel mount
- Cadmium free contact material
- Italian Patent

27.0x / 2x  
Screw terminal



For outline drawing see page 5

**Contact specification**

Number of contacts	1 or 2		1 or 2
Rated current/Maximum peak current	A		10/20
Rated voltage/ Maximum switching voltage	V AC	110/—	230/—
Rated load AC1	VA	1100	2300
Rated load AC15	VA	250	500
Nominal lamp rating:			
230 V incandescent/halogen W	—	1000	1000
fluorescent tubes with electronic ballast W	200	400	400
fluorescent tubes with electromagnetic ballast W	180	360	360
CFL W	100	200	200
230 V LED W	—	200	200
LV halogen or LED with electronic ballast W	100	200	200
LV halogen or LED with electromagnetic ballast W	200	400	400
Minimum switching current	mW (V/mA)	10	
Standard contact material		AgNi	

**Coil specification**

Nominal voltage (U <sub>N</sub> )	V AC (50/60 Hz)	110	230	230
	V DC	—		
Pickup/continuous power	VA (50 Hz)	4/4		25/1
Operating range	AC 50 Hz/AC 60 Hz	(0.8...1.1)U <sub>N</sub> / (0.85...1.1)U <sub>N</sub>		
	DC	—		

**Technical data**

Mechanical life AC/DC	cycles	300 · 10 <sup>3</sup>		300 · 10 <sup>3</sup>
Electrical life at rated load in AC1	cycles	100 · 10 <sup>3</sup>		100 · 10 <sup>3</sup>
Max no. of illuminated push-button	(≤ 1 mA)	4 (24 with module 027.00)		15
Minimum/Maximum impulse duration		0.1 s/1 h (according to EN 60669)		0.1 s/continuous
Ambient temperature range	°C	-40...+40		-40...+40
Protection category		IP 20		IP 20

**Approvals** (according to type)



27.0x



- Single or 2 double phase switch 1 NO (SPST-NO) or 2 NO (DPST-NO)

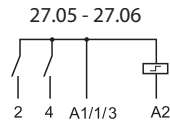
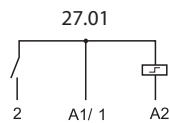

27.2x **EVO**



- Single or 2 double phase switch 1 NO (SPST-NO) or 2 NO (DPST-NO) with coil power limiter

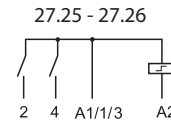
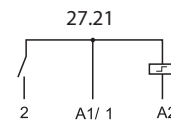

### Ordering information

Example: 27 series screw terminal, panel mount step relay, single phase switch 1 NO (SPST-NO) 10 A contact, coil rated 230 V AC.

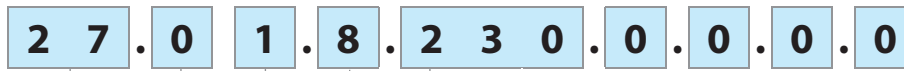

- Series** — 27
- Type** — 0 = Clamp terminal  
2 = Clamp terminal, with coil power limiter
- No. of poles** — 1 = Single phase switch 1 NO (SPST-NO)  
5 = 4 sequences double phase switch 2 NO (DPST-NO)  
6 = 3 sequences double phase switch 2 NO (DPST-NO)
- Coil voltage** — See coil specifications
- Coil version** — 8 = AC (50/60 Hz)

### Technical data

Other data	27.01, 27.21		27.05, 27.06, 27.25, 27.26		
Power lost to the environment with rated current and coil de-energised	W	0.9	1.8		
Screw torque	Nm	0.8	0.8		
Max. wire size		solid cable	stranded cable	solid cable	stranded cable
	mm <sup>2</sup>	2 x 2.5	1 x 4 / 2 x 2.5	2 x 2.5	1 x 4 / 2 x 2.5
	AWG	2 x 14	1 x 12 / 2 x 14	2 x 14	1 x 12 / 2 x 14

### Coil specifications

#### Types 27.01, 27.05, 27.06

Nominal voltage $U_N$ V	Coil code	Operating range (50 Hz)		Resistance R Ω	Consumption I at $U_N$ (50 Hz) mA
		$U_{min}$ V	$U_{max}$ V		
110	8.110	88	121	1400	42.0
230	8.230	184	253	6500	17.5

Type	Number of steps	Sequence			
		1	2	3	4
27.01/21	2				
27.05/25	4				
27.06/26	3				

#### Types 27.21, 27.25, 27.26

Nominal voltage $U_N$ V	Coil code	Operating range (50 Hz)		Resistance R Ω	Consumption	
		$U_{min}$ V	$U_{max}$ V		pick up I at $U_N$ (50 Hz) mA	continuous I at $U_N$ (50 Hz) mA
230	8.230	184	253	1250	100	4

### Wiring diagram

#### Type 27.01/05/06

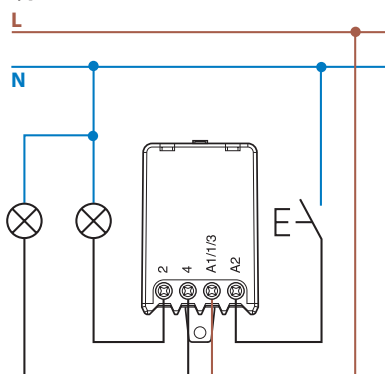

#### Type 27.21/25/26

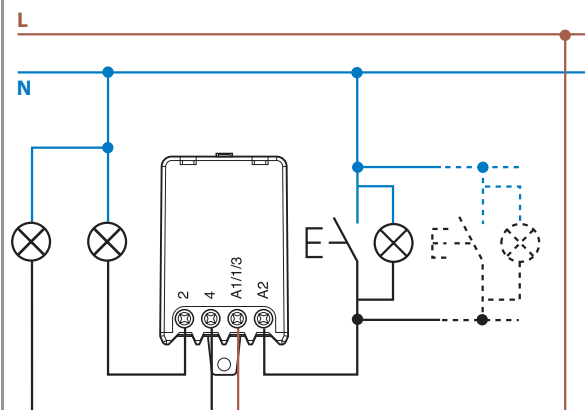

Accessories for types 27.01, 27.05, 27.06

Module for illuminated push-button (230 V AC applications)

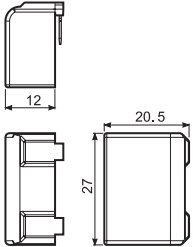

**Type 027.00**

This module is necessary if using up to a maximum of 24 illuminated push-buttons (1 mA max, 230 V AC) in the switching input circuit. It must be plugged directly into the relay.

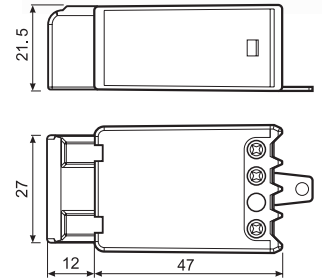
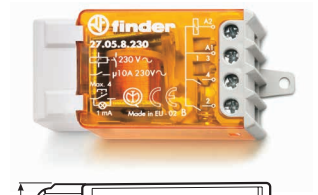

**Type 27.0x + 027.00**

Outline drawing

Types 27.0x / 2x  
Screw terminal

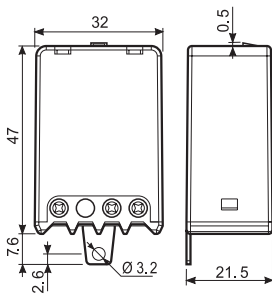



## X-ON Electronics

Largest Supplier of Electrical and Electronic Components

*Click to view similar products for [General Purpose Relays](#) category:*

*Click to view products by [Finder](#) manufacturer:*

Other Similar products are found below :

[PCN-105D3MH,000](#) [59641F200](#) [5JO-1000CD-SIL](#) [5X827E](#) [5X837F](#) [5X840F](#) [5X842F](#) [5X848E](#) [LY2N-AC120](#) [LY2-US-AC120](#) [M115C60](#)  
[M115N010](#) [M115N0150](#) [603-12D](#) [60HE1-5DC](#) [60HE2S-12DC](#) [61211T0B4](#) [61212T400](#) [61222Q400](#) [61243B600](#) [61243C500](#) [61243Q400](#)  
[61311BOA2](#) [61311BOA6](#) [61311BOA8](#) [61311C0A2](#) [61311COA1](#) [61311COA6](#) [61311F0A2](#) [61311QOA1](#) [61311QOA4](#) [61311T0D6](#)  
[61311TOA6](#) [61311TOA7](#) [61311TOB3](#) [61311TOB4](#) [61311U0A6](#) [61312Q600](#) [61312T400](#) [61312T600](#) [61313U200](#) [61313U400](#) [61322T400](#)  
[61332C400](#) [61343C200](#) [61343C600](#) [61343Q200](#) [61343T100](#) [61343T200](#) [61343T400](#)