

Features

Printed circuit mount 16 A Power relay

- 2 & 3 Pole changeover contacts or NO (≥ 3 mm contact gap)
- AC coils & DC coils
- Reinforced insulation between coil and contacts according to EN 60335-1, with 6 mm clearance & 8 mm creepage distance
- SELV coil-contact separator option
- Cadmium Free contact material options

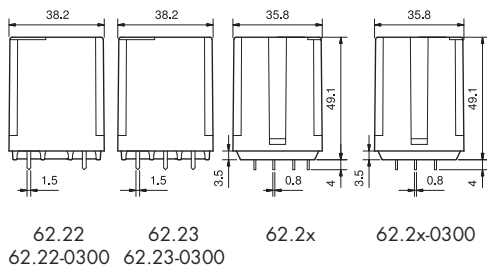

- * Distance between contacts ≥ 3 mm (EN 60730-1).
- ** With the AgSnO_2 material the maximum peak current is 120 A - 5 ms (NO contact).

FOR UL RATINGS SEE:
"General technical information" page V

62.22 / 62.23



- 2 & 3 pole changeover contact
- PCB mount

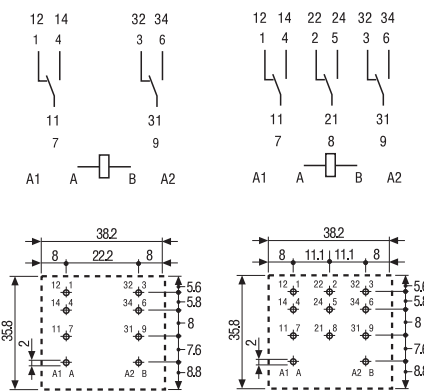

62.22-0300 / 62.23-0300



- 2 & 3 pole normally open contact (≥ 3 mm contact gap)
- PCB mount

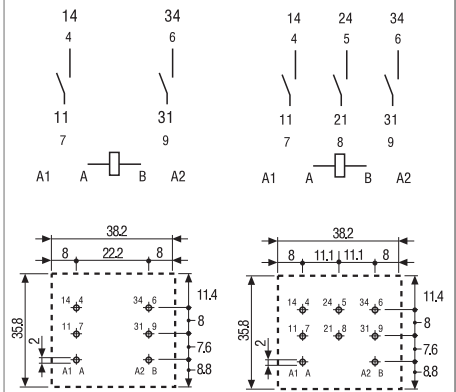

Contact specification		2 CO (DPDT)	3 CO (3PDT)	2 NO (DPST-NO), ≥ 3 mm*	3 NO (3PST-NO), ≥ 3 mm*
Contact configuration					
Rated current/Maximum peak current	A	16/30**		16/30**	
Rated voltage/Maximum switching voltage V AC		250/400		250/400	
Rated load AC1	VA	4,000		4,000	
Rated load AC15 (230 V AC)	VA	750		750	
Motor rating (230/400 V AC)	kW	0.8/—	0.8/1.5	0.8/—	0.8/1.5
Breaking capacity DC1: 30/110/220 V	A	16/0.6/0.4		16/1.1/0.7	
Minimum switching load	mW (V/mA)	1,000 (10/10)		1,000 (10/10)	
Standard contact material		AgCdO		AgCdO	
Coil specification					
Nominal voltage (U_N)	V AC (50/60 Hz)	6 - 12 - 24 - 48 - 60 - 110 - 120 - 230 - 240 - 400			
	V DC	6 - 12 - 24 - 48 - 60 - 110 - 125 - 220			
Rated power AC/DC	VA (50 Hz)/W	2.2/1.3		3/3	
Operating range	AC	$(0.8 \dots 1.1) U_N$		$(0.85 \dots 1.1) U_N$	
	DC	$(0.8 \dots 1.1) U_N$		$(0.85 \dots 1.1) U_N$	
Holding voltage	AC/DC	$0.8 U_N / 0.6 U_N$		$0.8 U_N / 0.6 U_N$	
Must drop-out voltage	AC/DC	$0.2 U_N / 0.1 U_N$		$0.2 U_N / 0.1 U_N$	
Technical data					
Mechanical life AC/DC	cycles	$10 \cdot 10^6 / 30 \cdot 10^6$		$10 \cdot 10^6 / 30 \cdot 10^6$	
Electrical life at rated load AC1	cycles	$100 \cdot 10^3$		$100 \cdot 10^3$	
Operate/release time	ms	11/4		15/3	
Insulation between coil and contacts (1.2/50 μ s)	kV	6		6	
Dielectric strength between open contacts	V AC	1,500		2,500	
Ambient temperature range	$^{\circ}$ C	-40...+70		-40...+50	
Environmental protection		RT I		RT I	
Approvals (according to type)					

Features

Plug-in mount/Faston 187 16 A Power relay

- Plug-in (92 series sockets) or Faston 187 (4.8x0.5 mm) with optional mounting adaptors
- 2 & 3 Pole changeover contacts or NO (≥ 3 mm contact gap)
- AC coils & DC coils
- UL Listing (certain relay/socket combinations)
- LED, mechanical indicator & test button options
- Reinforced insulation between coil and contacts according to EN 60335-1, with 6 mm clearance & 8 mm creepage distance
- SELV coil-contact separator option
- Cadmium Free contact material options
- Sockets and accessories
- European Patent

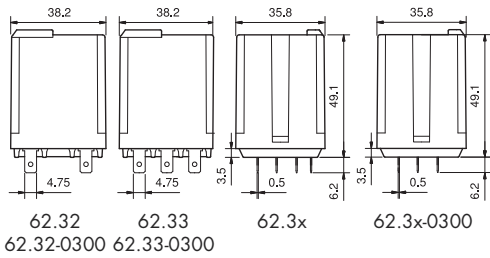

62.32 / 62.33



- 2 & 3 pole changeover contact
- Plug-in / Faston 187

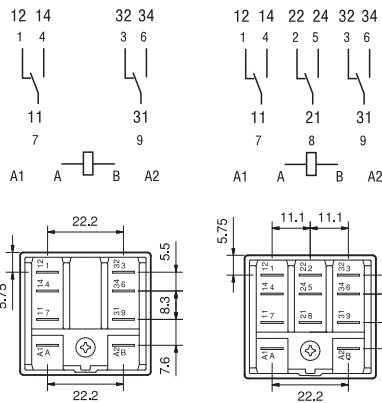

62.32-0300 / 62.33-0300



- 2 & 3 pole normally open contact (≥ 3 mm contact gap)
- Plug-in / Faston 187

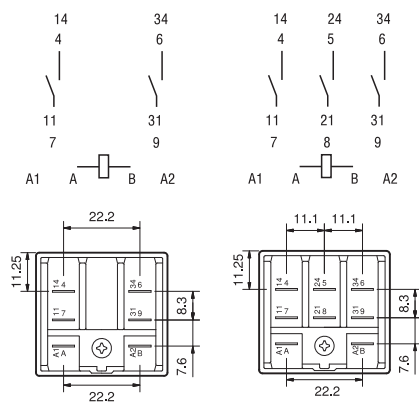

* Distance between contacts ≥ 3 mm (EN 60730-1).

** With the $AgSnO_2$ material the maximum peak current is 120 A - 5 ms (NO contact).

FOR UL RATINGS SEE:

"General technical information" page V

Contact specification

Contact configuration	2 CO (DPDT)	3 CO (3PDT)	2 NO (DPST-NO), ≥ 3 mm*	3 NO (3PST-NO), ≥ 3 mm*
Rated current/Maximum peak current	A	16/30**	16/30**	
Rated voltage/Maximum switching voltage V AC		250/400	250/400	
Rated load AC1	VA	4,000	4,000	
Rated load AC15 (230 V AC)	VA	750	750	
Motor rating (230/400 V AC)	kW	0.8/—	0.8/—	0.8/1.5
Breaking capacity DC1: 30/110/220 V	A	16/0.6/0.4		16/1.1/0.7
Minimum switching load	mW (V/mA)	1,000 (10/10)		1,000 (10/10)
Standard contact material		AgCdO		AgCdO

Coil specification

Nominal voltage (U_N)	V AC (50/60 Hz)	6 - 12 - 24 - 48 - 60 - 110 - 120 - 230 - 240 - 400		
	V DC	6 - 12 - 24 - 48 - 60 - 110 - 125 - 220		
Rated power AC/DC	VA (50 Hz)/W	2.2/1.3		3/3
Operating range	AC	$(0.8...1.1)U_N$		$(0.85...1.1)U_N$
	DC	$(0.8...1.1)U_N$		$(0.85...1.1)U_N$
Holding voltage	AC/DC	0.8 U_N /0.6 U_N		0.8 U_N /0.6 U_N
Must drop-out voltage	AC/DC	0.2 U_N /0.1 U_N		0.2 U_N /0.1 U_N

Technical data

Mechanical life AC/DC	cycles	10 · 10 ⁶ /30 · 10 ⁶		10 · 10 ⁶ /30 · 10 ⁶
Electrical life at rated load AC1	cycles	100 · 10 ³		100 · 10 ³
Operate/release time	ms	11/4		15/3
Insulation between coil and contacts (1.2/50 μ s)	kV	6		6
Dielectric strength between open contacts	V AC	1,500		2,500
Ambient temperature range	°C	-40...+70		-40...+50
Environmental protection		RT I		RT I

Approvals (according to type)



Features

Flange mount/Faston 250 16 A Power relay

- Faston 250 (6.3x0.8 mm) termination Flange or optional mounting adaptors
- 2 & 3 Pole changeover contacts or NO (≥ 3 mm contact gap)
- AC coils & DC coils
- LED, mechanical indicator & test button options
- Reinforced insulation between coil and contacts according to EN 60335-1, with 6 mm clearance & 8 mm creepage distance
- SELV coil-contact separator option
- Cadmium Free contact material options
- European Patent

62.82 / 62.83



- 2 & 3 pole changeover contact
- Flange mount / Faston 250

62.82-0300 / 62.83-0300



- 2 & 3 pole normally open contact (≥ 3 mm contact gap)
- Flange mount / Faston 250

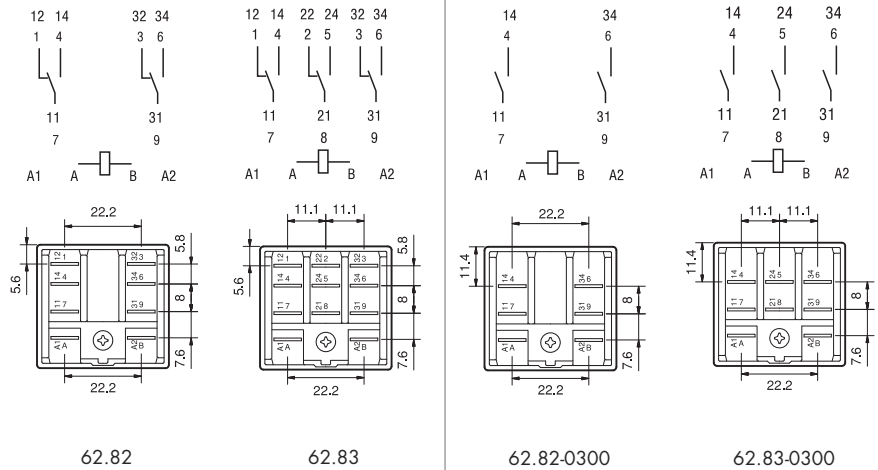
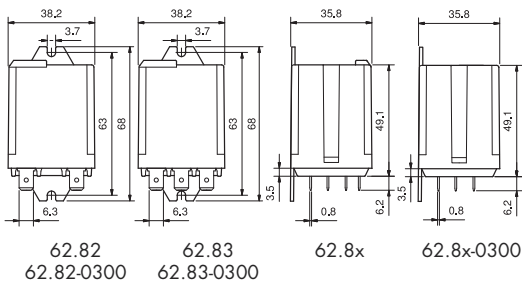

* Distance between contacts ≥ 3 mm (EN 60730-1).
 ** With the AgSnO_2 material the maximum peak current is 120 A - 5 ms (NO contact).
 FOR UL RATINGS SEE:
 "General technical information" page V

Contact specification		62.82		62.83		62.82-0300		62.83-0300	
Contact configuration		2 CO (DPDT)		3 CO (3PDT)		2 NO (DPST-NO), ≥ 3 mm*		3 NO (3PST-NO), ≥ 3 mm*	
Rated current/Maximum peak current	A	16/30**		16/30**		16/30**		16/30**	
Rated voltage/Maximum switching voltage V AC		250/400		250/400		250/400		250/400	
Rated load AC1	VA	4,000		4,000		4,000		4,000	
Rated load AC15 (230 V AC)	VA	750		750		750		750	
Motor rating (230/400 V AC)	kW	0.8/-		0.8/1.5		0.8/-		0.8/1.5	
Breaking capacity DC1: 30/110/220 V	A	16/0.6/0.4		16/0.6/0.4		16/1.1/0.7		16/1.1/0.7	
Minimum switching load	mW (V/mA)	1,000 (10/10)		1,000 (10/10)		1,000 (10/10)		1,000 (10/10)	
Standard contact material		AgCdO		AgCdO		AgCdO		AgCdO	
Coil specification		62.82		62.83		62.82-0300		62.83-0300	
Nominal voltage (U_N)	V AC (50/60 Hz)	6 - 12 - 24 - 48 - 60 - 110 - 120 - 230 - 240 - 400		6 - 12 - 24 - 48 - 60 - 110 - 120 - 230 - 240 - 400		6 - 12 - 24 - 48 - 60 - 110 - 120 - 230 - 240 - 400		6 - 12 - 24 - 48 - 60 - 110 - 120 - 230 - 240 - 400	
	V DC	6 - 12 - 24 - 48 - 60 - 110 - 125 - 220		6 - 12 - 24 - 48 - 60 - 110 - 125 - 220		6 - 12 - 24 - 48 - 60 - 110 - 125 - 220		6 - 12 - 24 - 48 - 60 - 110 - 125 - 220	
Rated power AC/DC	VA (50 Hz)/W	2.2/1.3		2.2/1.3		3/3		3/3	
Operating range	AC	$(0.8 \dots 1.1) U_N$		$(0.8 \dots 1.1) U_N$		$(0.85 \dots 1.1) U_N$		$(0.85 \dots 1.1) U_N$	
	DC	$(0.8 \dots 1.1) U_N$		$(0.8 \dots 1.1) U_N$		$(0.85 \dots 1.1) U_N$		$(0.85 \dots 1.1) U_N$	
Holding voltage	AC/DC	$0.8 U_N / 0.6 U_N$		$0.8 U_N / 0.6 U_N$		$0.8 U_N / 0.6 U_N$		$0.8 U_N / 0.6 U_N$	
Must drop-out voltage	AC/DC	$0.2 U_N / 0.1 U_N$		$0.2 U_N / 0.1 U_N$		$0.2 U_N / 0.1 U_N$		$0.2 U_N / 0.1 U_N$	
Technical data		62.82		62.83		62.82-0300		62.83-0300	
Mechanical life AC/DC	cycles	$10 \cdot 10^6 / 30 \cdot 10^6$		$10 \cdot 10^6 / 30 \cdot 10^6$		$10 \cdot 10^6 / 30 \cdot 10^6$		$10 \cdot 10^6 / 30 \cdot 10^6$	
Electrical life at rated load AC1	cycles	$100 \cdot 10^3$		$100 \cdot 10^3$		$100 \cdot 10^3$		$100 \cdot 10^3$	
Operate/release time	ms	11/4		11/4		15/3		15/3	
Insulation between coil and contacts (1.2/50 μ s)	kV	6		6		6		6	
Dielectric strength between open contacts	V AC	1,500		1,500		2,500		2,500	
Ambient temperature range	$^{\circ}$ C	$-40 \dots +70$		$-40 \dots +70$		$-40 \dots +70$		$-40 \dots +70$	
Environmental protection		RT I		RT I		RT I		RT I	
Approvals (according to type)		CE		CE		RINA		cUL US	

Ordering information

Example: 62 series power relay + Faston 250 (6.3x0.8 mm), rear flange mount, 2 NO (DPST-NO), 12 V DC coil.

6	2	.	8	.	2	.	9	.	0	1	2	.	0	A	B	C	D	0
----------	----------	----------	----------	----------	----------	----------	----------	----------	----------	----------	----------	----------	----------	----------	----------	----------	----------	----------

Series ————

Type
 2 = PCB
 3 = Plug-in
 8 = Faston 250 (6.3x0.8 mm) with rear flange mount

No. of poles
 2 = 2 pole
 3 = 3 pole

Coil version
 8 = AC (50/60 Hz)
 9 = DC

Coil voltage
 See coil specifications

A: Contact material
 0 = Standard AgCdO
 4 = AgSnO₂

B: Contact circuit
 0 = CO (nPDT)
 3 = NO (nPST), ≥ 3 mm contact gap
 5 = CO (nPDT) + additional physical separator between coil and contacts (for SELV applications)
 6 = NO (nPST), ≥ 3 mm contact gap + additional physical separator between coil and contacts (for SELV applications)

D: Special versions
 0 = Standard
 6 = Rear flange mount
 9 = Type 62.82/83 without rear flange mount

C: Options
 0 = None
 2 = Mechanical indicator
 3 = LED (AC)
 4 = Lockable test button + mechanical indicator
 5* = Lockable test button + LED (AC)
 54* = Lockable test button + LED (AC) + mechanical indicator
 6* = LED + diode (DC, polarity positive to pin A/A1)
 7* = Lockable test button + LED + diode (DC, polarity positive to pin A/A1)
 74* = Lockable test button + LED + diode (DC, polarity positive to pin A/A1) + mechanical indicator

Selecting features and options: only combinations in the same row are possible.
 Preferred selections for best availability are shown in **bold**.

Type	Coil version	A	B	C	D
62.22/23	AC-DC	0 - 4	0 - 3 - 5 - 6	0	0
62.32/33	AC-DC	0 - 4	0 - 3 - 5 - 6	0	0 - 6
	AC-DC	0 - 4	0 - 5	2 - 4	0 - 6
	AC	0 - 4	0	2 - 3 - 4 - 5	0 - 6
	AC	0 - 4	0 - 3	3	0 - 6
	AC	0 - 4	0	54	/
	DC	0 - 4	0	4 - 6 - 7	0 - 6
	DC	0 - 4	0 - 3	6	0 - 6
	DC	0 - 4	0	74	/
62.82/83	AC-DC	0 - 4	0 - 3 - 5 - 6	0	0 - 9
	AC-DC	0 - 4	0 - 5	2 - 4	0
	AC	0 - 4	0	2 - 3 - 4 - 5	0
	AC	0 - 4	0 - 3	3	0
	DC	0 - 4	0	4 - 6 - 7	0
	DC	0 - 4	0 - 3	6	0

* Options not available for 220 V DC and 400 V AC versions.

Descriptions: Options and Special versions

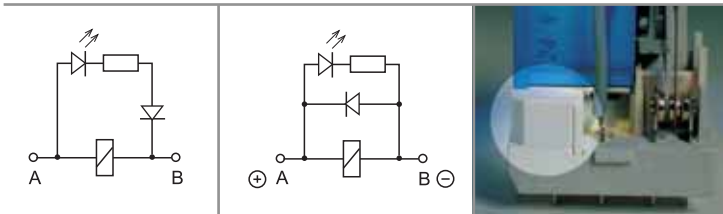

C: Option 3, 5, 54
LED (AC)

C: Option 6, 7, 74
LED + diode (DC, polarity positive to pin A/A1)

B: Contact circuit 5, 6
Additional physical separator between coil and contacts (for SELV applications)



Lockable test button and mechanical flag indicator (0040, 0050, 0054, 0070, 0074)

The dual-purpose Finder test button can be used in two ways:

Case 1) The plastic pip (located directly above the test button) remains intact. In this case, when the test button is pushed, the contacts operate. When the test button is released the contacts return to their former state.

Case 2) The plastic pip is broken-off (using an appropriate cutting tool). In this case, (in addition to the above function), when the test button is pushed and rotated, the contacts are latched in the operating state, and remain so until the test button is rotated back to its former position. In both cases ensure that the test button actuation is swift and decisive.



Technical data

Insulation according to EN 61810-1						
		2 CO - 3 CO		2 NO - 3 NO		
Nominal voltage of supply system	V AC	230/400		230/400		
Rated insulation voltage	V AC	400		400		
Pollution degree		3		3		
Insulation between coil and contact set						
Type of insulation		Reinforced		Reinforced		
Overvoltage category		III		III		
Rated impulse voltage	kV (1.2/50 µs)	6		6		
Dielectric strength	V AC	4,000		4,000		
Insulation between adjacent contacts						
Type of insulation		Basic		Basic		
Overvoltage category		III		III		
Rated impulse voltage	kV (1.2/50 µs)	4		4		
Dielectric strength	V AC	2,500		2,500		
Insulation between open contacts						
Type of disconnection		Micro-disconnection		Full-disconnection		
Overvoltage category		—		III		
Rated impulse voltage	kV (1.2/50 µs)	—		4		
Dielectric strength	V AC/kV (1.2/50 µs)	1,500/2		2,500/4		
Conducted disturbance immunity						
Burst (5...50)ns, 5 kHz, on A1 - A2		EN 61000-4-4		level 4 (4 kV)		
Surge (1.2/50 µs) on A1 - A2 (differential mode)		EN 61000-4-5		level 4 (4 kV)		
Other data						
Bounce time: NO/NC	ms	1/5 (changeover)		3/— (normally open)		
Vibration resistance (10...150)Hz: NO/NC	g	20/8				
Shock resistance	g	15				
Power lost to the environment		2 pole (CO)	3 pole (CO)	2 pole (NO)	3 pole (NO)	
	without contact current	W	1.3	1.3	3	3
	with rated current	W	3.3	4.3	5	6
Recommended distance between relays mounted on PCB	mm	≥ 5				

Contact specification

F 62 - Electrical life (AC) v contact current

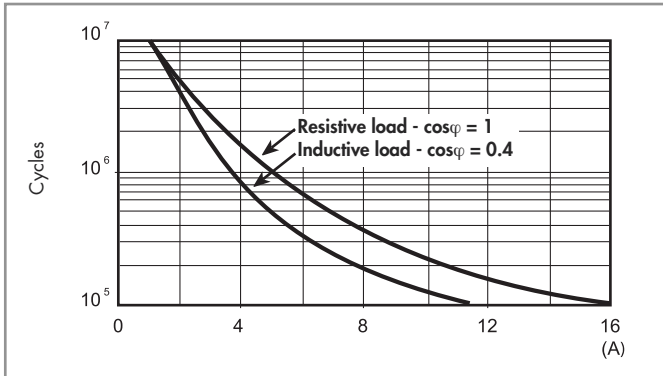

H 62 - Maximum DC1 breaking capacity Changeover contacts

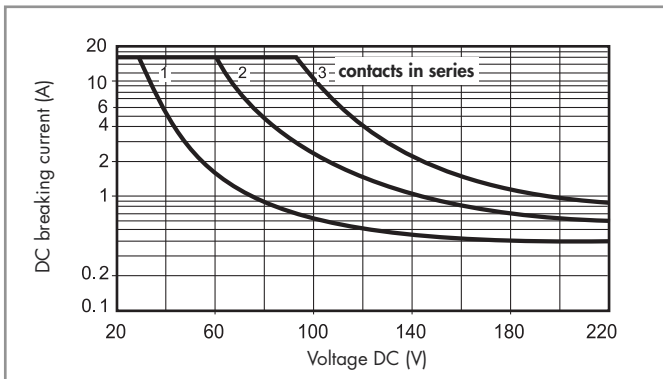

H 62 - Maximum DC1 breaking capacity Normally open contacts

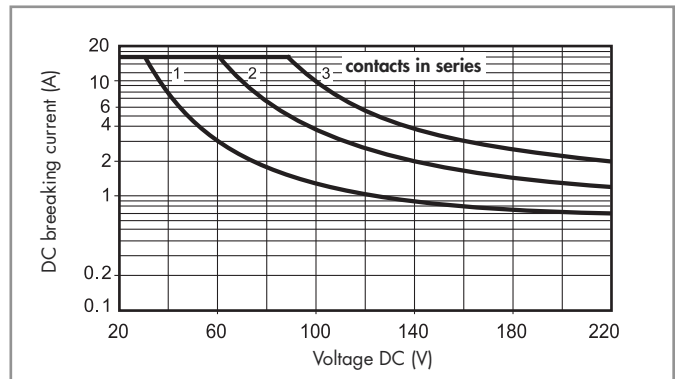

- When switching a resistive load (DC1) having voltage and current values under the curve, an electrical life of $\geq 100 \cdot 10^3$ can be expected.
- In the case of DC13 loads, the connection of a diode in parallel with the load will permit a similar electrical life as for a DC1 load.
Note: the release time of the load will be increased.

Coil specifications

DC version data

Nominal voltage U_N V	Coil code	Operating range		Resistance R Ω	Rated coil consumption I at U_N mA
		U_{min} V	U_{max} V		
6	9.006	4.8	6.6	28	214
12	9.012	9.6	13.2	110	109
24	9.024	19.2	26.4	445	54
48	9.048	38.4	52.8	1,770	27
60	9.060	48	66	2,760	21.7
110	9.110	88	121	9,420	11.7
125	9.125	100	138	12,000	10.4
220	9.220	176	242	37,300	5.8

AC version data

Nominal voltage U_N V	Coil code	Operating range		Resistance R Ω	Rated coil consumption I at U_N (50Hz) mA
		U_{min} V	U_{max} V		
6	8.006	4.8	6.6	4.6	367
12	8.012	9.6	13.2	19	183
24	8.024	19.2	26.4	74	90
48	8.048	38.4	52.8	290	47
60	8.060	48	66	450	37
110	8.110	88	121	1,600	20
120	8.120	96	132	1,940	18.6
230	8.230	184	253	7,250	10.5
240	8.240	192	264	8,500	9.2
400	8.400	320	440	19,800	6

DC (NO/nPST-NO) version data - ≥ 3 mm

Nominal voltage U_N V	Coil code	Operating range		Resistance R Ω	Rated coil consumption I at U_N mA
		U_{min} V	U_{max} V		
6	9.006	5.1	6.6	12	500
12	9.012	10.2	13.2	48	250
24	9.024	20.4	26.4	192	125
48	9.048	40.8	52.8	770	63
60	9.060	51	66	1,200	50
110	9.110	93.5	121	4,200	26
125	9.125	106	138	5,200	24
220	9.220	187	242	17,600	12.5

AC (NO/nPST-NO) version data - ≥ 3 mm

Nominal voltage U_N V	Coil code	Operating range		Resistance R Ω	Rated coil consumption I at U_N (50Hz) mA
		U_{min} V	U_{max} V		
6	8.006	5.1	6.6	4	540
12	8.012	10.2	13.2	14	275
24	8.024	20.4	26.4	62	130
48	8.048	40.8	52.8	220	70
60	8.060	51	66	348	55
110	8.110	93.5	121	1,200	30
120	8.120	106	137	1,350	24
230	8.230	196	253	5,000	14
240	8.240	204	264	6,300	12.5
400	8.400	340	440	14,700	7.8

R 62 - DC coil operating range v ambient temperature
Changeover contacts

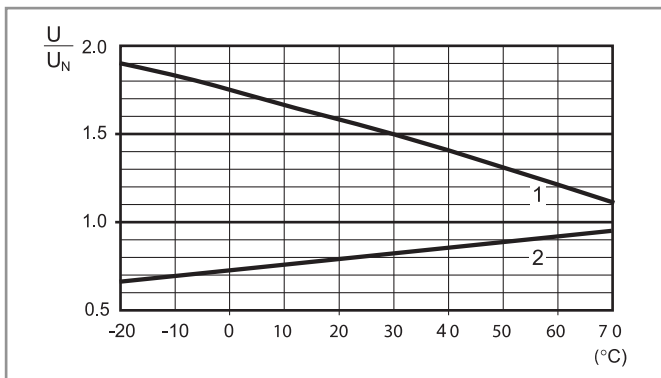

R 62 - AC coil operating range v ambient temperature
Changeover contacts

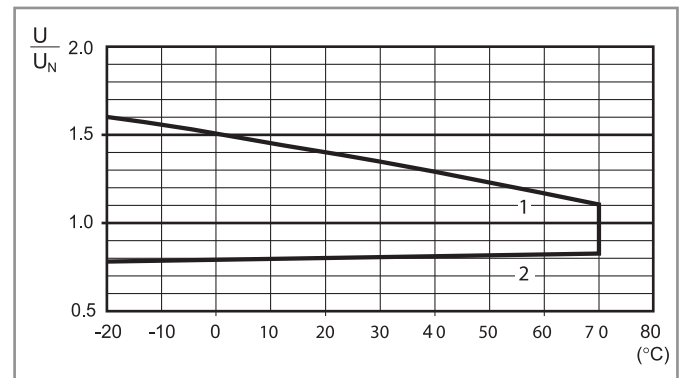

R 62 - DC coil operating range v ambient temperature
Normally open contacts

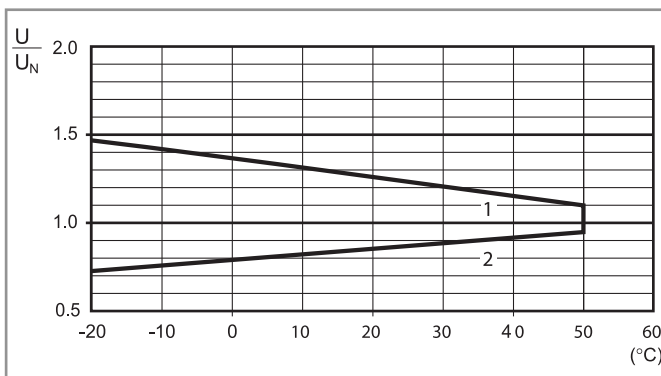

R 62 - AC coil operating range v ambient temperature
Normally open contacts

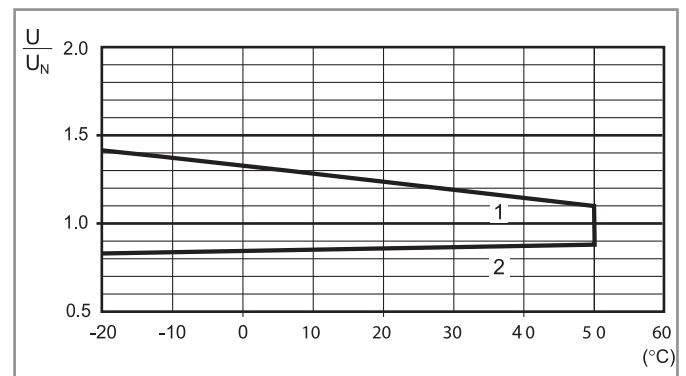

1 - Max. permitted coil voltage.
2 - Min. pick-up voltage with coil at ambient temperature.

1 - Max. permitted coil voltage.
2 - Min. pick-up voltage with coil at ambient temperature.

Accessories



062.10



062.10 with relay

Mounting adaptor for types 62.3x and 62.8x.xxxx.xxx9 (M4)

062.10

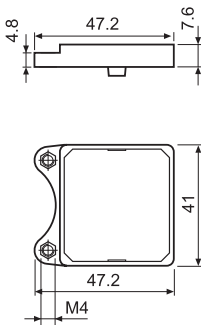

062.10

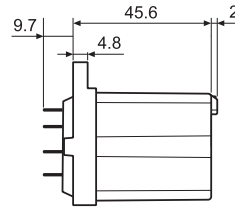
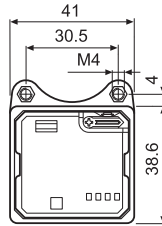

062.10 with relay

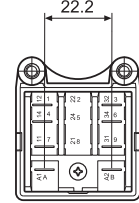

062.60



062.60 with relay

Flange mounting adaptor for types 62.3x and 62.8x.xxxx.xxx9

062.60

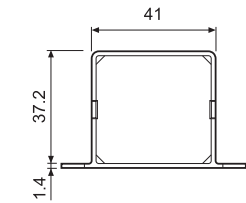

062.60

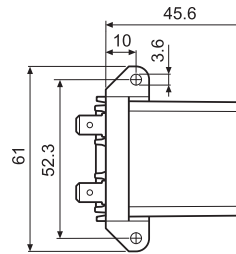

062.60 with relay

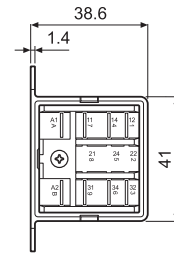

062.05



062.05 with relay

Top flange mount for types 62.3x and 62.8x.xxxx.xxx9

062.05

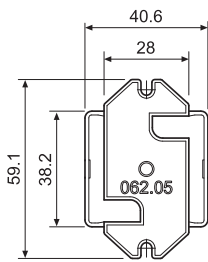

062.05

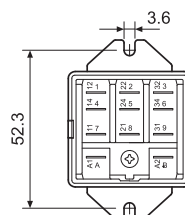
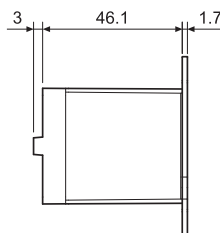

062.05 with relay

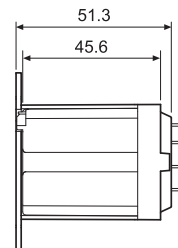

062.07



062.07 with relay

Top 35 mm rail (EN 60715) mount for types 62.3x and 62.8x.xxxx.xxx9

062.07

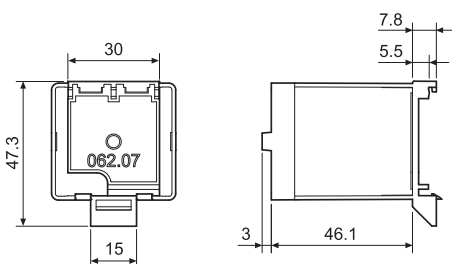

062.07

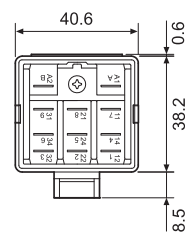

062.07 with relay

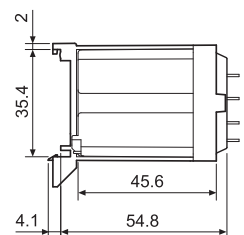

Accessories



062.08



062.08 with relay

Rear 35 mm rail (EN 60715) mount for types 62.3x and 62.8x.xxxx.xxx9 | 062.08

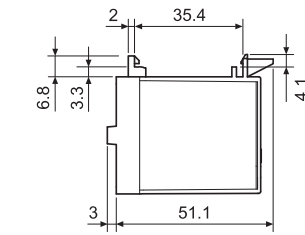
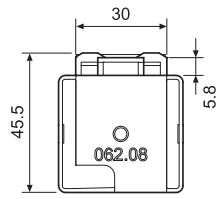

062.08

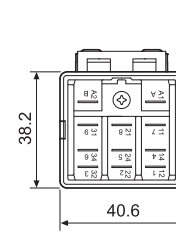

062.08 with relay

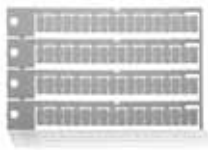
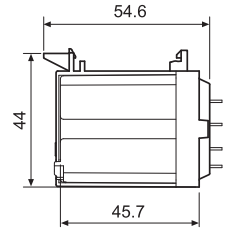

060.72

Sheet of marker tags for 62 series relays, plastic, 72 tags, 6x12 mm | 060.72

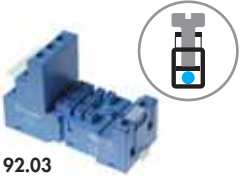

92.03

Approvals (according to type):



Screw terminal (Box clamp) socket panel or 35 mm rail (EN 60715) mount For relay type	92.03 Blue 62.32, 62.33	92.03.0 Black	
Accessories			
Metal retaining clip (supplied with socket - packaging code SMA)		092.71	
Identification tag		092.00.2	
Modules (see table below)		99.02	
Timer modules (see table below)		86.00, 86.30	
Technical data			
Rated values	16 A - 250 V		
Dielectric strength	6 kV (1.2/50 µs) between coil and contacts		
Protection category	IP 20		
Ambient temperature	°C -40...+70 (see diagram L92)		
Screw torque	Nm	0.8	
Wire strip length	mm	10	
Max. wire size for 92.03 socket	solid wire	stranded wire	
	mm ²	1x10 / 2x4	1x6 / 2x4
	AWG	1x8 / 2x12	1x10 / 2x12

L 92 - Rated current vs ambient temperature

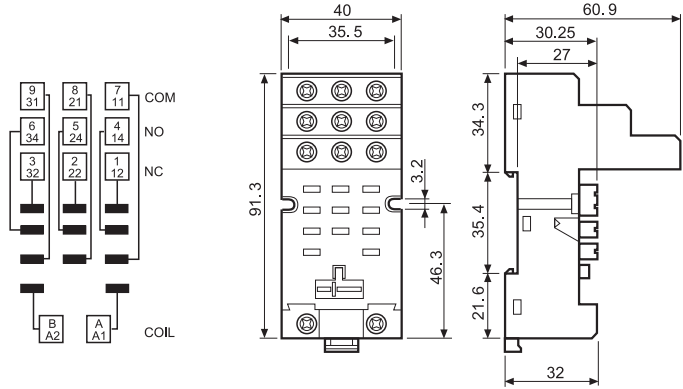
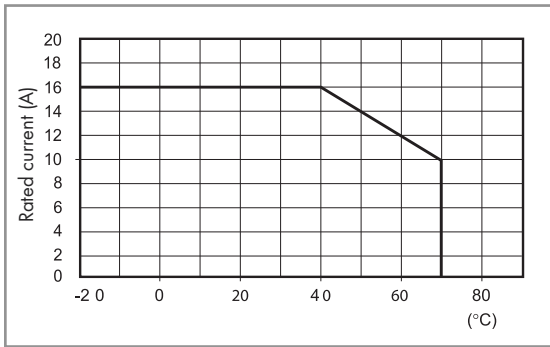

86.00



86.30



99.02

Approvals (according to type):



DC Modules with non-standard polarity (+A2) on request.

86 series timer modules		
Multi-voltage: (12...240)V AC/DC;		
Multi-functions: AI, DI, SW, BE, CE, DE, EE, FE; (0.05s...100h)		86.00.0.240.0000
(12...24)V AC/DC; Bi-function: AI, DI; (0.05s...100h)		86.30.0.024.0000
(110...125)V AC; Bi-function: AI, DI; (0.05s...100h)		86.30.8.120.0000
(230...240)V AC; Bi-function: AI, DI; (0.05s...100h)		86.30.8.240.0000

Approvals (according to type):

99.02 coil indication and EMC suppression modules for 92.03 socket		
Diode (+A1, standard polarity)	(6...220)V DC	99.02.3.000.00
LED	(6...24)V DC/AC	99.02.0.024.59
LED	(28...60)V DC/AC	99.02.0.060.59
LED	(110...240)V DC/AC	99.02.0.230.59
LED + Diode (+A1, standard polarity)	(6...24)V DC	99.02.9.024.99
LED + Diode (+A1, standard polarity)	(28...60)V DC	99.02.9.060.99
LED + Diode (+A1, standard polarity)	(110...220)V DC	99.02.9.220.99
LED + Varistor	(6...24)V DC/AC	99.02.0.024.98
LED + Varistor	(28...60)V DC/AC	99.02.0.060.98
LED + Varistor	(110...240)V DC/AC	99.02.0.230.98
RC circuit	(6...24)V DC/AC	99.02.0.024.09
RC circuit	(28...60)V DC/AC	99.02.0.060.09
RC circuit	(110...240)V DC/AC	99.02.0.230.09
Residual current by-pass	(110...240)V AC	99.02.8.230.07



92.13

Approvals
(according to type):



PCB socket	92.13 (blue)	92.13.0 (black)
For relay type	62.32, 62.33	
Accessories		
Metal retaining clip (supplied with socket - packaging code SMA)	092.54	
Technical data		
Rated values	10 A - 250 V	
Dielectric strength	2.5 kV AC	
Ambient temperature	°C -40...+70	

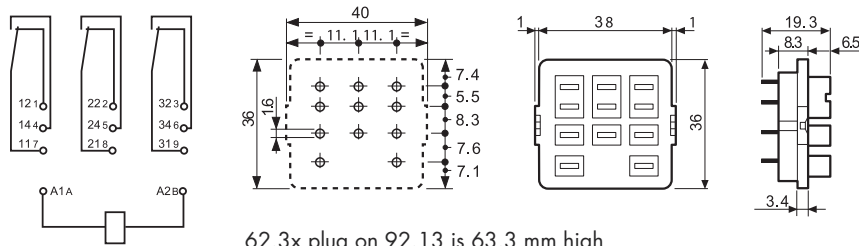

92.33

Approvals
(according to type):



Panel mount solder socket mounted with M3 screw	92.33 (blue)	
For relay type	62.32, 62.33	
Accessories		
Metal retaining clip (supplied with socket - packaging code SMA)	092.54	
Technical data		
Rated values	10 A - 250 V	
Dielectric strength	2.5 kV AC	
Ambient temperature	°C -40...+70	

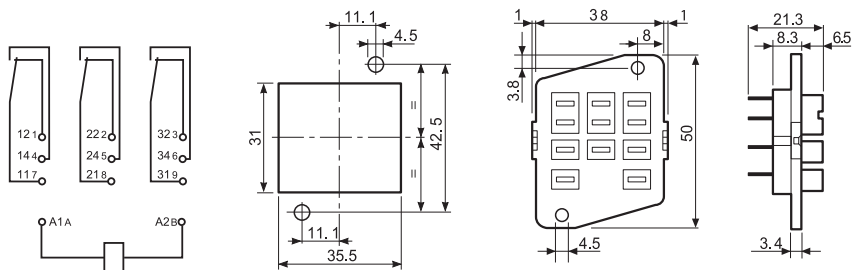

Packaging code

How to code and identify retaining clip and packaging options for sockets.

Example:

9 2 . 0 3 S M A

A Standard packaging

SM Metal retaining clip

9 2 . 0 3 [] []

Without retaining clip

X-ON Electronics

Largest Supplier of Electrical and Electronic Components

Click to view similar products for [Industrial Relays](#) category:

Click to view products by [Finder](#) manufacturer:

Other Similar products are found below :

[6-1618400-7](#) [686-117111](#) [686-120111](#) [EV250-4A-02](#) [EV250-6A-01](#) [FCA-125-CX8](#) [FCA-410-138](#) [8-1618393-1](#) [GCA32A208VAC60HZ](#)
[GCA32A220VAC50/60HZ](#) [GCA32A230VAC50/60HZ](#) [GCA32A240VAC50/60HZ](#) [GCA32A48VAC60HZ](#) [GCA63A120VAC50/60HZ](#)
[GCA63A208VAC60HZ](#) [GCA63A220VAC60HZ](#) [GCA63A230VAC50/60HZ](#) [GCA63A240VAC50/60HZ](#) [GCA63A277VAC60HZ](#)
[GCA63A48VAC60HZ](#) [GCA63A500VAC50/60HZ](#) [GCA63A600VAC60HZ](#) [GCA800A200VACDC](#) [GCA95A110VAC50/60HZ](#)
[GCA95A120VAC50/60HZ](#) [GCA95A12VDC](#) [GCA95A240VAC50/60HZ](#) [GCA95A24VAC50/60HZ](#) [GCA95A48VAC60HZ](#) [ACC530U20](#)
[ACC730U30](#) [1395832-1](#) [RM699BV-3011-85-1005](#) [RMIA210230AC](#) [RMIA45024AC](#) [1423675-8](#) [B07B032AC1-0329](#) [B329](#) [1617807-1](#)
[N417](#) [P25-E5019-1](#) [P30C42A12D1-120](#) [2-1618398-1](#) [PBO-18A1218](#) [2307497](#) [RPYA00324LT](#) [RPYA003A120LT](#) [KR-4539-1](#)
[RT334012WG](#) [S160156115](#)