

Solid State Relays

5 - 15 - 30 - 50 A

77
SERIES



Drying kilns



Heating and cooling



Lighting control
in corridors (for
hotels, offices
and hospitals)



Bottling plant



Labelling
machines



Packaging
machines



5 A modular SSR, 1 NO AC output

- 17.5 mm housing
- 60 to 240 V AC output (with back to back SCR)
- 5 kV (1.2/50 µs) insulation between Input and Output
- Zero-crossing and random switch-on versions available
- High switching speed
- High endurance
- Silent switching
- Spark and bounce-free switching
- Low control power
- 3-phase general purpose
- 35 mm rail (EN 60715) mount

77.01

Screw terminal



* See L77-3 diagram page 13

** See L77-1 and L77-2 diagrams page 12

For outline drawing see page 16

Output specification

Output configuration	1 NO (SPST-NO)		1 NO (SPST-NO)	
Rated current I _N /Max. peak current* (10 ms)	A	5/300*	5/300*	
Rated voltage	V AC (50/60 Hz)	230	230	
Switching voltage range	V AC (50/60 Hz)	48...265	48...265	
Repetitive peak off-state voltage	V _{pk}	800	800	
Rated load AC7a (cos φ = 0.8)	A	5	5	
Rated load AC15	A	5	3	
Single phase motor rating (230 V AC)	kW	—	0.1	
Nominal lamp rating:				
230 V incandescent/halogen W		1000	800	
fluorescent tubes with electronic ballast W		1000	800	
fluorescent tubes with electromagnetic ballast W		1000	800	
CFL W		800	400	
230 V LED W		800	400	
LV halogen or LED with electronic ballast W		800	400	
LV halogen or LED with electromagnetic ballast W		1000	800	
Minimum switching current @ 230 V	mA	100	100	
Typical "OFF-state" leakage current @ 230 V	mA	0.5	3.5	
Max "ON-state" voltage drop @ 25 °C and 5 A/100 mA	V	0.85/1.5	0.85/1.5	
Power loss @ 5 A	W	4	4	

Input specification

Nominal voltage (U _N)	V AC (50/60 Hz)	24	230	24	230
	V DC	12...24	—	12...24	—
Rated power	VA (50 Hz)/W	0.6/0.5	3.6/0.3	0.6/0.5	3.6/0.3
Operating range	V AC (50/60 Hz)	16...32	90...265	16...32	90...265
	V DC	9.8...32	—	9.8...32	—
Must drop-out voltage	V AC (50/60 Hz)/DC	2.4	24	2.4	24

Technical data

Electrical life	cycles	10 · 10 ⁶	10 · 10 ⁶
Operate/release time	ms	20/12	9/8
Insulation between input and output (1.2/50 µs)	kV	5	5
Ambient temperature	°C	-20...+70**	-20...+70**
Protection category		IP 20	IP 20

Approvals (according to type)



77.01.x.xxx.8050



**Zero-crossing switch-on
Suggested applications:**

- Lamp inrush current reduction (CFL - Compact Fluorescent energy-saving Lamps and similar)
- Heater control
- Solenoid, contactor driver

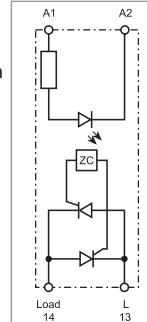

77.01.x.xxx.8051



**Random switch-on
Suggested applications:**

- Finer control requiring short operate time (specially motor control)
- AC Input phase different from AC Output phase

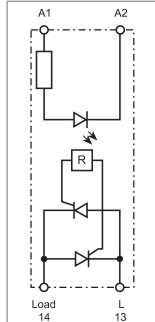

7 - 15 A modular SSR, 1 NO DC output

- 17.5 mm housing
- 2 versions, for 24 and 125 V DC mosfet output
- 4 kV (1.2/50 μ s) insulation between Input and Output
- Short circuit protection
- High switching speed
- High endurance
- Silent switching
- Spark and bounce-free switching
- Low control power
- Suitable for railway applications
- 35 mm rail (EN 60715) mount

77.01

Screw terminal



* See L77-12 and L77-13 diagrams page 12

For outline drawing see page 16

Output specification

Output configuration		1 NO (SPST-NO)	1 NO (SPST-NO)
Rated current I_N /Max. peak current (10 ms)	A	15/160	7/60
Rated voltage	V DC	24	125
Switching voltage range	V DC	16...32	43...140
Rated load DC13	A	5	2.5
DC motor rating	kW	0.2	—
Minimum switching current	mA	100	50
Typical "OFF-state" leakage current	mA	3	6
Max "ON-state" voltage drop @ 25 °C and I_N	V	0.06	0.2
Power loss @ I_N	W	1	1.5

Input specification

Nominal voltage (U_N)	V DC	6...24	6...24
Rated power	W	0.5	0.5
Operating range	V DC	4...36	4...36
Must drop-out voltage	V DC	3	3

Technical data

Electrical life	cycles	$10 \cdot 10^6$	$10 \cdot 10^6$
Operate/release time	ms	0.05/2	0.05/2
Insulation between input and output (1.2/50 μ s)	kV	4	4
Ambient temperature	°C	-20...+70*	-20...+70*
Protection category		IP 20	IP 20

Approvals (according to type)



77.01.9.024.9024



**24 V DC output switching
15 A rated**

Applications in Energy, Automation and Machines:

- Control of electric, pneumatic and hydraulic electromagnetic valves
- Direct control of loads such as motors and electromagnets

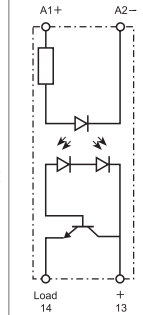

Simplified circuit diagram

77.01.9.024.9125



**110...125 V DC output switching
7 A rated**

Applications in Energy, Automation and Machines:

- Control of electric, pneumatic and hydraulic electromagnetic valves
- Direct control of loads such as motors and electromagnets

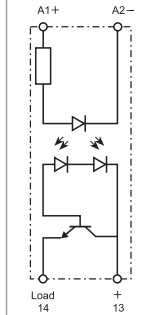

Simplified circuit diagram

15 A modular SSR, 1 NO output

- 22.5 mm housing, heat-sink + plastic cover
- 24 to 277 V AC output (with triac)
- 6 kV (1.2/50 μs) insulation between Input and Output
- Zero-crossing and random switch-on versions available
- High switching speed
- High endurance
- Silent switching
- Spark and bounce-free switching
- Low control power
- 3-phase general purpose
- "Relay-style" terminal arrangement (input and output terminals on opposite sides)
- 35 mm rail (EN 60715) mount

77.11
Screw terminal



* See L77-7 diagram page 13
** See L77-6 diagrams page 12

For outline drawing see page 16

Output specification

Output configuration	1 NO (SPST-NO)		1 NO (SPST-NO)	
Rated current I _N /Max. peak current* (10 ms) A	15/400*		15/400*	
Rated voltage V AC (50/60 Hz)	230		230	
Switching voltage range V AC (50/60 Hz)	19...305		19...305	
Repetitive peak off-state voltage V _{pk}	800		800	
Rated load AC7a (cos φ = 0.8, @ 25 °C) A	20		20	
Rated load AC15 A	15		15	
Single phase motor rating (230 V AC) kW	—		0.75	
Nominal lamp rating:				
230 V incandescent/halogen W	4000		2500	
fluorescent tubes with electronic ballast W	4000		2500	
fluorescent tubes with electromagnetic ballast W	2000		1000	
CFL W	3000		1500	
230 V LED W	3000		1500	
LV halogen or LED with electronic ballast W	3000		1500	
LV halogen or LED with electromagnetic ballast W	3000		1500	
Minimum switching current @ 250 V mA	100		100	
Typical "OFF-state" leakage current @ 250 V mA	1		1	
Max "ON-state" voltage drop @ 25 °C and 15 A V	1.55		1.55	
Power loss @ 15 A W	14		14	

Input specification

Nominal voltage (U _N)	V AC (50/60 Hz)	—	230	—	230
	V DC	24	—	24	—
Rated power VA (50 Hz)/W		0.4	7.5/0.9	0.4	7.5/0.9
Operating range	V AC (50/60 Hz)	—	40...305	—	40...305
	V DC	4...32	—	4...32	—
Must drop-out voltage	V AC (50/60 Hz)/DC	—/2	6/—	—/2	6/—

Technical data

Electrical life	cycles	10 · 10 ⁶		10 · 10 ⁶	
Operate/release time	ms	< 10/< 10	< 10/< 30	< 1/< 10	< 2/< 25
Insulation between input and output (1.2/50 μs)	kV	6		6	
Ambient temperature	°C	-20...+80**		-20...+80**	
Protection category		IP 20		IP 20	

Approvals (according to type)



77.11.x.xxx.8250



Zero-crossing switch-on

Suggested applications:

- Lamp inrush current reduction (CFL - Compact Fluorescent energy-saving Lamps and similar)
- Heater control
- Solenoid, contactor driver

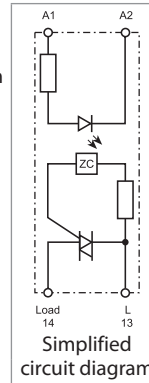

77.11.x.xxx.8251



Random switch-on

Suggested applications:

- Fine controls involving shorter time (specially motor control)

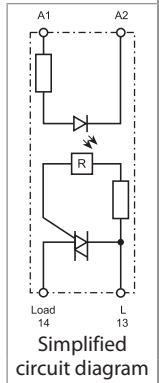

30 A modular SSR, 1 NO output

- 22.5 mm housing, heat-sink + plastic cover
- 60 to 440 V AC output (with back to back SCR)
- 6 kV (1.2/50 μs) insulation between Input and Output
- Zero-crossing and random switch-on versions available
- High switching speed
- High endurance
- Silent switching
- Spark and bounce-free switching
- Low control power
- 3-phase general purpose
- "Relay-style" terminal arrangement (input and output terminals on opposite sides)
- 35 mm rail (EN 60715) mount

77.31

Screw terminal



* See L77-5 diagram page 13

** See L77-4 diagrams page 12

For outline drawing see page 16

Output specification

Output configuration	1 NO (SPST-NO)		1 NO (SPST-NO)	
Rated current I _N /Max. peak current* (10 ms) A	30/520*		30/520*	
Rated voltage V AC (50/60 Hz)	400		400	
Switching voltage range V AC (50/60 Hz)	48...480		48...480	
Repetitive peak off-state voltage V _{pk}	1100		1100	
Rated load AC7a (cos φ = 0.8) A	30		30	
Rated load AC15 A	20		20	
Single phase motor rating (230 V AC) kW	—		1.5	
Nominal lamp rating:				
230 V incandescent/halogen W	6000		4500	
fluorescent tubes with electronic ballast W	6000		4000	
fluorescent tubes with electromagnetic ballast W	3000		1800	
CFL W	4000		2500	
230 V LED W	4000		2500	
LV halogen or LED with electronic ballast W	4000		2500	
LV halogen or LED with electromagnetic ballast W	4000		2500	
Minimum switching current @ 400 V mA	300		300	
Typical "OFF-state" leakage current @ 400 V mA	1		1	
Max "ON-state" voltage drop @ 25 °C and 30 A V	0.85		0.85	
Power loss @ 30 A W	16		16	

Input specification

Nominal voltage (U _N)	V AC (50/60 Hz)	—	230	—	230
	V DC	24	—	24	—
Rated power @ U _{MAX}	VA (50 Hz)/W	0.4	7.5/0.9	0.4	7.5/0.9
Operating range	V AC (50/60 Hz)	—	40...280	—	40...280
	V DC	4...32	—	4...32	—
Must drop-out voltage	V AC (50/60 Hz)/DC	—/2	6/—	—/2	6/—

Technical data

Electrical life	cycles	10 · 10 ⁶		10 · 10 ⁶	
Operate/release time	ms	< 10/< 10	< 10/< 30	< 1/< 10	< 2/< 25
Insulation between input and output (1.2/50 μs)	kV	6		6	
Ambient temperature	°C	-20...+80**		-20...+80**	
Protection category		IP 20		IP 20	

Approvals (according to type)



77.31.x.xxx.8050



Zero-crossing switch-on
Suggested applications:

- Lamp inrush current reduction (CFL - Compact Fluorescent energy-saving Lamps and similar)
- Heater control
- Solenoid, contactor driver

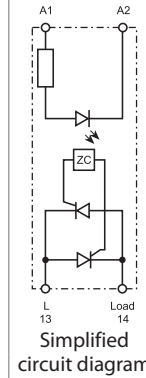

77.31.x.xxx.8051



Random switch-on
Suggested applications:

- Finer control requiring short operate time (specially motor control)

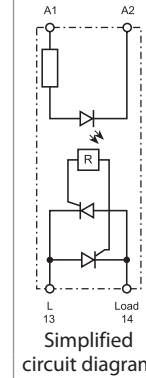

30 A modular SSR, 1 NO output

- 22.5 mm housing, heat-sink + plastic cover
- 60 to 440 V AC output (with back to back SCR)
- 6 kV (1.2/50 μ s) insulation between Input and Output
- Zero-crossing and random switch-on versions available
- High switching speed
- High endurance
- Silent switching
- Spark and bounce-free switching
- Low control power
- 3-phase general purpose
- "Contactor-style" terminal arrangement (input and output terminals on adjacent sides)
- 35 mm rail (EN 60715) mount

77.31
Screw terminal



* See L77-5 diagram page 13
** See L77-4 diagrams page 12

For outline drawing see page 16

Output specification

Output configuration	1 NO (SPST-NO)		1 NO (SPST-NO)	
Rated current I_N /Max. peak current* (10 ms) A	30/520*		30/520*	
Rated voltage V AC (50/60 Hz)	400		400	
Switching voltage range V AC (50/60 Hz)	48...480		48...480	
Repetitive peak off-state voltage V_{pk}	1100		1100	
Rated load AC7a (cos φ = 0.8) A	30		30	
Rated load AC15 A	20		20	
Single phase motor rating (230 V AC) kW	—		1.5	
Nominal lamp rating:				
230 V incandescent/halogen W	6000		4500	
fluorescent tubes with electronic ballast W	6000		4000	
fluorescent tubes with electromagnetic ballast W	3000		1800	
CFL W	4000		2500	
230 V LED W	4000		2500	
LV halogen or LED with electronic ballast W	4000		2500	
LV halogen or LED with electromagnetic ballast W	4000		2500	
Minimum switching current @ 400 V mA	300		300	
Typical "OFF-state" leakage current @ 400 V mA	1		1	
Max "ON-state" voltage drop @ 25 °C and 30 A V	0.85		0.85	
Power loss @ 30 A W	16		16	

Input specification

Nominal voltage (U_N)	V AC (50/60 Hz)	—	230	—	230
	V DC	24	—	24	—
Rated power VA (50 Hz)/W		0.4	7.5/0.9	0.4	7.5/0.9
Operating range	V AC (50/60 Hz)	—	40...280	—	40...280
	V DC	4...32	—	4...32	—
Must drop-out voltage V AC (50/60 Hz)/DC		—/2	6/—	—/2	6/—

Technical data

Electrical life cycles		10 · 10 ⁶		10 · 10 ⁶	
Operate/release time ms		< 10/< 10	< 10/< 30	< 1/< 10	< 2/< 25
Insulation between input and output (1.2/50 μ s) kV		6		6	
Ambient temperature °C		-20...+80**		-20...+80**	
Protection category		IP 20		IP 20	

Approvals (according to type)



77.31.x.xxx.8070



Zero-crossing switch-on

Suggested applications:

- Lamp inrush current reduction (CFL - Compact Fluorescent energy-saving Lamps and similar)
- Heater control
- Solenoid, contactor driver

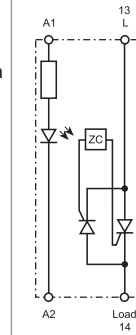

Simplified circuit diagram

77.31.x.xxx.8071



Random switch-on

Suggested applications:

- Fine controls involving shorter time (specially motor control)

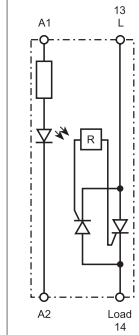

Simplified circuit diagram

25, 40 And 50 A panel SSR, "hockey puck" style

- "hockey puck" housing with cover
- 24 to 240 V AC output
- Zero-crossing version
- High switching speed
- High endurance
- Silent switching
- Spark and bounce-free switching
- Low control power
- 3-phase general purpose
- "Relay-style" terminal arrangement (input and output terminals on opposite sides)
- Mounting on heatsink with screws

77.x5
Screw terminal (plate clamp)



* See L77-11 diagrams page 13
** See L77-8, L77-9 and L77-10 diagrams page 13

For outline drawing see page 16

77.25.x.xxx.8250



Zero-crossing switch-on
• Output: 25 A/230 V AC
• Suggested applications: heater control

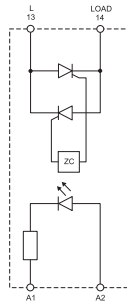

Simplified circuit diagram

77.45.x.xxx.8250



Zero-crossing switch-on
• Output: 40 A/230 V AC
• Suggested applications: heater control

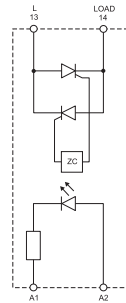

Simplified circuit diagram

77.55.x.xxx.8250



Zero-crossing switch-on
• Output: 50 A/230 V AC
• Suggested applications: heater control

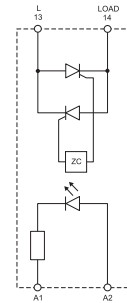

Simplified circuit diagram

Output specification

Output configuration	1 NO (SPST-NO)	
Rated current I_N /Max. peak current* (10 ms) A	25/300*	40/500*
Rated voltage V AC (50/60 Hz)	230	230
Switching voltage range V AC (50/60 Hz)	21.6...280	21.6...280
Repetitive peak off-state voltage V_{pk}	600	600
Nominal lamp rating:		
230 V incandescent/halogen W	2000	4000
fluorescent tubes with electronic ballast W	2000	4000
fluorescent tubes with electromagnetic ballast W	1000	2000
CFL W	800	3000
230 V LED W	800	3000
LV halogen or LED with electronic ballast W	800	3000
LV halogen or LED with electromagnetic ballast W	1000	3000
Minimum switching current @ 250 V mA	120	250
Typical "OFF-state" leakage current @ 250 V mA	10	10
Max "ON-state" voltage drop @ 25 °C and I_N V	1.6	1.6
Power loss @ I_N W	40	64

Input specification

Nominal voltage (U_N)	V AC (50/60 Hz)	—	230	—	230	—	230
	V DC	24	—	24	—	24	—
Rated power @ U_{MAX}	VA (50 Hz)/W	—/0.6	2.4/—	—/0.6	2.4/—	—/0.6	2.4/—
Operating range	V AC (50/60 Hz)	—	90...280	—	90...280	—	90...280
	V DC	3...32	—	3...32	—	3...32	—
Must drop-out voltage	V AC (50/60 Hz)/DC	—/1	10/—	—/1	10/—	—/1	10/—

Technical data

Electrical life	cycles	10 · 10 ⁶	
Operate/release time	ms	10/10	40/80
Insulation between input and output (1.2/50 μs)	kV	5.6	
Ambient temperature	°C	-30...+80**	
Protection category		IP 20	

Approvals (according to type)



25, 40 And 50 A panel SSR, "hockey puck" style

- "hockey puck" housing with cover
- 48 to 600 V AC output
- Zero-crossing version
- High switching speed
- High endurance
- Silent switching
- Spark and bounce-free switching
- Low control power
- 3-phase general purpose
- "Relay-style" terminal arrangement (input and output terminals on opposite sides)
- Mounting on heatsink with screws

77.x5

Screw terminal (plate clamp)



* See L77-11 diagrams page 13

** See L77-8, L77-9 and L77-10 diagrams page 13

For outline drawing see page 16

Output specification

Output configuration

1 NO (SPST-NO)

1 NO (SPST-NO)

1 NO (SPST-NO)

Rated current I_N /Max. peak current* (10 ms) A

25/300*

40/500*

50/520*

Rated voltage V AC (50/60 Hz)

600

600

600

Switching voltage range V AC (50/60 Hz)

43.2...660

43.2...660

43.2...660

Repetitive peak off-state voltage V_{pk}

1200

1200

1200

Nominal lamp rating:

230 V incandescent/halogen W

2000

4000

6000

fluorescent tubes with

electronic ballast W

2000

4000

6000

fluorescent tubes with

electromagnetic ballast W

1000

2000

3000

CFL W

800

3000

4000

230 V LED W

800

3000

4000

LV halogen or LED with

electronic ballast W

800

3000

4000

LV halogen or LED with

electromagnetic ballast W

1000

3000

4000

Minimum switching current @ 250 V mA

120

250

250

Typical "OFF-state" leakage current @ 250 V mA

10

10

10

Max "ON-state" voltage drop

@ 25 °C and I_N V

1.6

1.6

1.6

Power loss @ I_N W

40

64

80

Input specification

Nominal voltage (U_N) V AC (50/60 Hz)

—

230

—

230

—

230

V DC

24

—

24

—

24

—

Rated power @ U_{MAX} VA (50 Hz)/W

—/0.6

2.4/—

—/0.6

2.4/—

—/0.6

2.4/—

Operating range V AC (50/60 Hz)

—

90...280

—

90...280

—

90...280

V DC

4...32

—

4...32

—

4...32

—

Must drop-out voltage V AC (50/60 Hz)/DC

—/1

10/—

—/1

10/—

—/1

10/—

Technical data

Electrical life cycles

$10 \cdot 10^6$

$10 \cdot 10^6$

$10 \cdot 10^6$

Operate/release time ms

10/10

40/80

10/10

40/80

10/10

40/80

Insulation between input and output (1.2/50 μ s) kV

5.6

5.6

5.6

Ambient temperature °C

−30...+80**

−30...+80**

−30...+80**

Protection category

IP 20

IP 20

IP 20

Approvals (according to type)

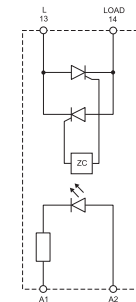
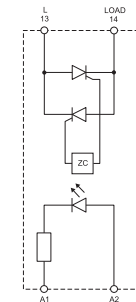
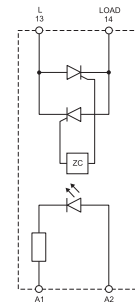

Ordering information

Example: 77 series modular SSR, 1 output 30 A AC, input voltage 230 V AC, relay style terminals arrangement, zero-crossing switch-on.

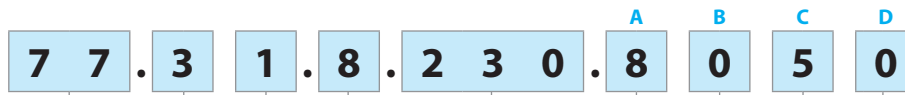

- Series**
- Type/rated current**
 0 = 5/7/15 A output (77.01)
 1 = 15 A output (77.11)
 2 = 25 A output (77.25)
 3 = 30 A output (77.31)
 4 = 40 A output (77.45)
 5 = 50 A output (77.55)
- No. of poles/mounting**
 1 = 1 pole, modular housing (plastic or heat sink/plastic), DIN rail mounting
 5 = 1 pole, heat-sink or directly panel mounting ("hockey puck")
- Input version**
 0 = DC/AC (50/60 Hz)
 8 = AC (50/60 Hz)
 9 = DC
- Supply voltage**
 See "input specification"
- D: Switch-on mode**
 0 = Zero-crossing
 1 = Random
- C: Terminals arrangement**
 5 = "Relay style" (input and output on opposite sides)
 7 = "Contactor style" (input and output on adjacent sides)
- AB: Output circuit (rated voltage)**
 80 = 230 V AC (77.01), 400 V AC (77.31)
 82 = 230 V AC (77.11, 77.x5)
 86 = 600 V AC (77.x5)
 9024 = 24 V DC
 9125 = 110...125 V DC

Codes/Module width	77.11.8.230.8250/22.5 mm 15 A	77.31.8.230.8050/22.5 mm 30 A	77.25.8.230.8250/hockey puck 25 A
77.01.8.230.8050/17.5 mm 5 A	77.11.9.024.8250/22.5 mm 15 A	77.31.9.024.8050/22.5 mm 30 A	77.25.9.024.8250/hockey puck 25 A
77.01.0.024.8050/17.5 mm 5 A	77.11.8.230.8251/22.5 mm 15 A	77.31.8.230.8051/22.5 mm 30 A	77.25.8.230.8650/hockey puck 25 A
77.01.8.230.8051/17.5 mm 5 A	77.11.8.230.8251/22.5 mm 15 A	77.31.9.024.8051/22.5 mm 30 A	77.25.9.024.8650/hockey puck 25 A
77.01.0.024.8051/17.5 mm 5 A		77.31.8.230.8070/22.5 mm 30 A	77.45.8.230.8250/hockey puck 40 A
77.01.9.024.9125/17.5 mm 7 A		77.31.9.024.8070/22.5 mm 30 A	77.45.9.024.8250/hockey puck 40 A
77.01.9.024.9024/17.5 mm 15 A		77.31.8.230.8071/22.5 mm 30 A	77.45.8.230.8650/hockey puck 40 A
		77.31.9.024.8071/22.5 mm 30 A	77.45.9.024.8650/hockey puck 40 A
			77.55.8.230.8250/hockey puck 50 A
			77.55.9.024.8250/hockey puck 50 A
			77.55.8.230.8650/hockey puck 50 A
			77.55.9.024.8650/hockey puck 50 A

Technical data

		77.01.8xxx		77.01.9xxx		77.11		77.31		77.25/45/55			
		Dielectric strength	Impulse (1.2/50 µs)	Dielectric strength	Impulse (1.2/50 µs)	Dielectric strength	Impulse (1.2/50 µs)	Dielectric strength	Impulse (1.2/50 µs)	Dielectric strength	Impulse (1.2/50 µs)		
Between input and output		2500 V AC	5 kV	3000 V AC	4 kV	3000 V AC	6 kV	3000 V AC	6 kV	4000 V AC	5.6 kV		
Between input and ground (heat-sink)		—	—	—	—	3000 V AC	6 kV	3000 V AC	6 kV	4000 V AC	5.6 kV		
Between output and ground (heat-sink)		—	—	—	—	2500 V AC	4 kV	4000 V AC	6 kV	4000 V AC	5.6 kV		
EMC specifications		Reference standard		77.01.x.xxx		77.01.9.xxx		77.11		77.31		77.25/45/55	
		24 V AC/DC, 230 V AC		24 V DC		24 V DC, 230 V AC		24 V DC, 230 V AC		24 V DC, 230 V AC		24 V DC - 230 V AC	
Electrostatic discharge	contact discharge	EN 61000-4-2		4 kV		4 kV		4 kV		4 kV		4 kV	
	air discharge	EN 61000-4-2		8 kV		8 kV		8 kV		8 kV		8 kV	
Radiated electromagnetic field (80...1000 MHz)		EN 61000-4-3		30 V/m		—		20 V/m		30 V/m		—	
Fast transients on supply terminals (burst 5/50 ns, 5 and 100 kHz)		EN 61000-4-4		1 kV, 4 kV		2 kV		1 kV, 3 kV		1 kV, 3 kV		2 kV	
Voltage pulses on supply terminals (surge 1.2/50 µs)	common mode	EN 61000-4-5		2 kV, 4 kV		1 kV		3 kV, 3 kV		3 kV, 3 kV		2 kV	
	differential mode	EN 61000-4-5		1 kV, 4 kV		0.5 kV		0.5 kV, 1.5 kV		0.5 kV, 1.5 kV		1 kV	
Radio-frequency common mode voltage (0.15...230 MHz) on supply terminals		EN 61000-4-6		—		10 V		10 V		10 V		—	
Terminals		77.01.x.xxx		77.01.9.xxx		77.11		77.31		77.25/45/55		Input Output	
Screw torque		Nm		0.8		0.8		0.8		0.8		0.5, 1.2	
Max. wire size		solid cable, stranded cable		solid cable, stranded cable		solid cable, stranded cable		solid cable, stranded cable		solid cable, stranded cable		solid and stranded cable	
		mm ²		mm ²		mm ²		mm ²		mm ²		mm ²	
		1x6/2x4, 1x4/2x25		1x6/2x4, 1x4/2x25		1x6/2x4, 1x4/2x25		1x6/2x4, 1x4/2x25		1x6/2x4, 1x4/2x25		1 (with ferrule), 4 (with ferrule), 10 (with fork tip)	
		AWG		AWG		AWG		AWG		AWG		AWG	
		1x10/2x12, 1x12/2x14		1x10/2x12, 1x12/2x14		1x10/2x12, 1x12/2x14		1x10/2x12, 1x12/2x14		1x10/2x12, 1x12/2x14		18 (with ferrule), 12 (with ferrule), 8 (with fork tip)	
Wire strip length		mm		mm		mm		mm		mm		mm	
		9		9		9		9		10		10	
Other data													
Power lost to the environment without output current		W		0.5		0.5		0.9		0.9		0.6	
with rated current		W		4.0		4.0		14		16		40/64/80	

Input specification

77.01

Nominal voltage	Input code	Operating range				Must drop-out voltage (AC/DC)	Input current I_N at U_N
		AC		DC			
		U_{min}	U_{max}	U_{min}	U_{max}		
U_N		V	V	V	V	V	mA
24	0.024	16	32	9.8	32	2.4	25
24	9.024	—	—	4	32	3.0	18
230	8.230	90	265	—	—	24	15

77.11

Nominal voltage	Input code	Operating range				Must drop-out voltage (AC/DC)	Input current I_N at U_N
		AC		DC			
		U_{min}	U_{max}	U_{min}	U_{max}		
U_N		V	V	V	V	V	mA
24	9.024	—	—	4	32	2	11
230	8.230	40	305	—	—	6	25

77.31

Nominal voltage	Input code	Operating range				Must drop-out voltage (AC/DC)	Input current I_N at U_N
		AC		DC			
		U_{min}	U_{max}	U_{min}	U_{max}		
U_N		V	V	V	V	V	mA
24	9.024	—	—	4	32	2	11
230	8.230	40	280	—	—	6	25

77.x5.x.xxx.8250

Nominal voltage	Input code	Operating range				Must drop-out voltage (AC/DC)	Input current I_N at U_N
		AC		DC			
		U_{min}	U_{max}	U_{min}	U_{max}		
U_N		V	V	V	V	V	mA
24	9.024	—	—	3	32	1	22
230	8.230	90	280	—	—	10	20

77.x5.x.xxx.8650

Nominal voltage	Input code	Operating range				Must drop-out voltage (AC/DC)	Input current I_N at U_N
		AC		DC			
		U_{min}	U_{max}	U_{min}	U_{max}		
U_N		V	V	V	V	V	mA
24	9.024	—	—	4	32	1	25
230	8.230	90	280	—	—	10	10

Led indication

LED	Supply voltage
	OFF
	ON

LED (77.01.9.024.9xxx only)	Short circuit*
	NO
	YES

* To restore normal operation it is necessary to disconnect the power, resolve the short circuit and then restore power.

D

Output specification

L77-1 Output RMS current v ambient temperature
77.01.0.024.805x @ 32 V DC

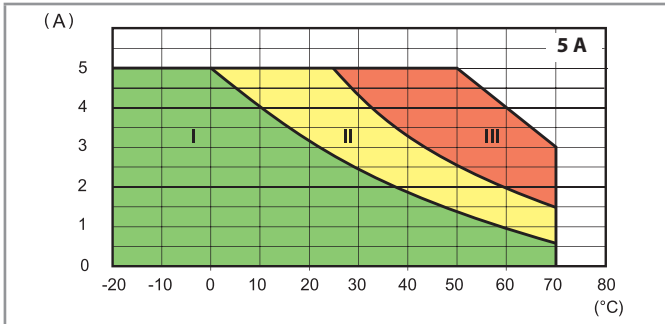

L77-2 Output RMS current v ambient temperature
77.01.8.230.805x @ 265 V AC

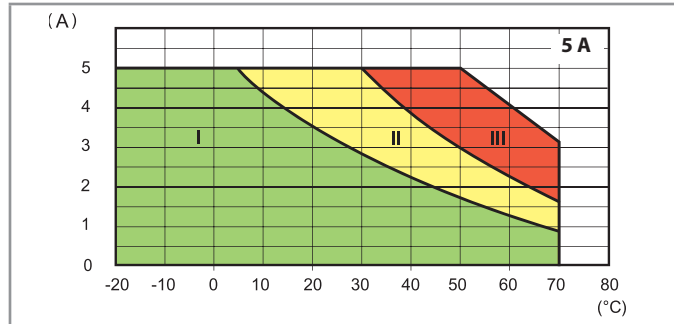

- I - Modular SSR installed as a group (without gap)
- II - Modular SSR installed as a group (9 mm gap between each SSR)
- III - Modular SSR installed individually in free air (without a significant influence from nearby components)

L77-12 Output DC current v ambient temperature
77.01.9.024.9024 @ 32 V DC

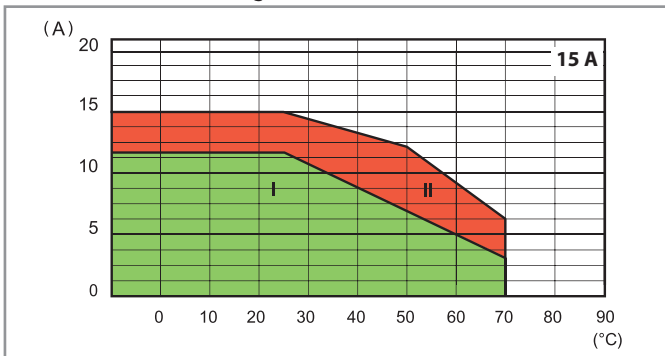

L77-13 Output DC current v ambient temperature
77.01.9.024.9125 @ 32 V DC

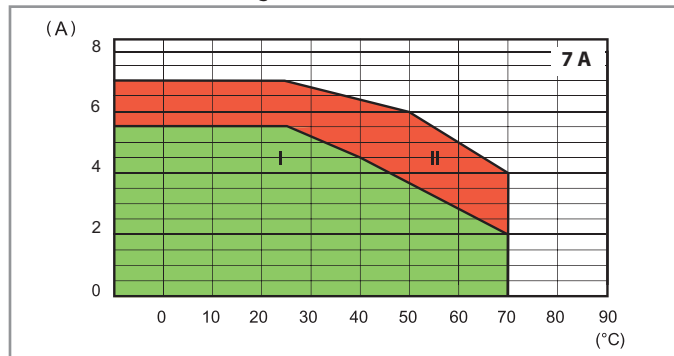

- I - Modular SSR installed as a group (without gap)
- II - Modular SSR installed individually in free air, or with a gap ≥ 9 mm, which implies a not significant influence from nearby components

L77-6 Output RMS current v ambient temperature
77.11.x.xxx.82xx

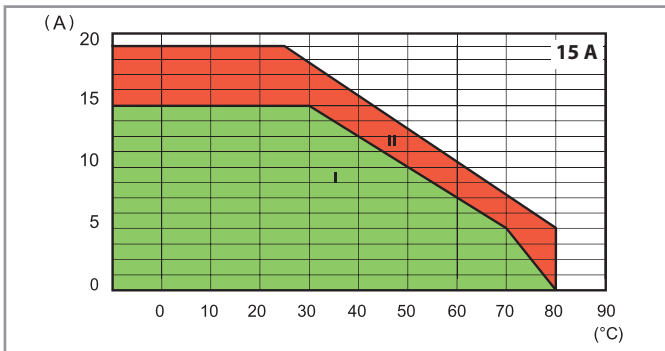

L77-4 Output RMS current v ambient temperature
77.31.x.xxx.80xx

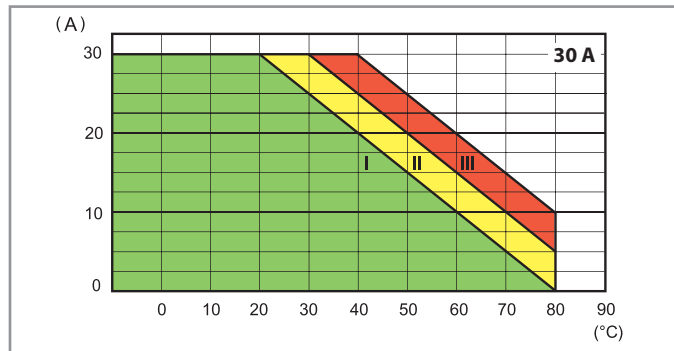

- I - Modular SSR installed as a group (without gap)
- II - Modular SSR installed as a group (20 mm gap between each SSR)
- III - Modular SSR installed individually in free air, or with a gap ≥ 40 mm, which implies a not significant influence from nearby components)

Output specification

L77-10 Output RMS current v ambient temperature
77.25.x.xxx.8x50

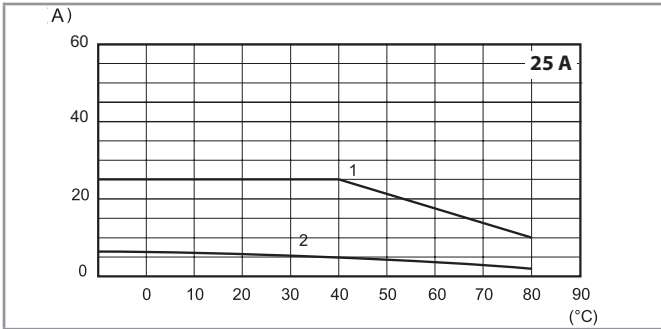

- 1 - Installation on 077.25 heat-sink (2 K/W)
- 2 - Installation individually in free-air

L77-9 Output RMS current v ambient temperature
77.45.x.xxx.8x50

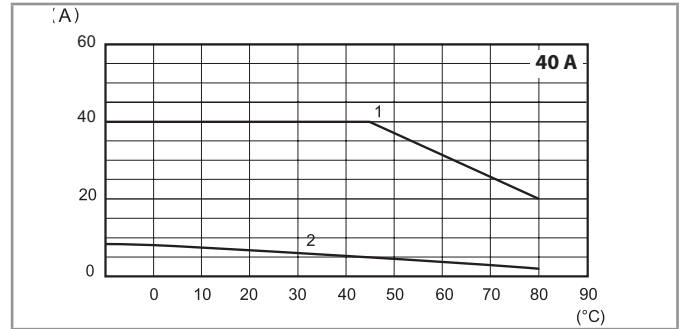

- 1 - Installation on 077.55 heat-sink (0.9 K/W)
- 2 - Installation individually in free-air

L77-8 Output RMS current v ambient temperature
77.55.x.xxx.8x50

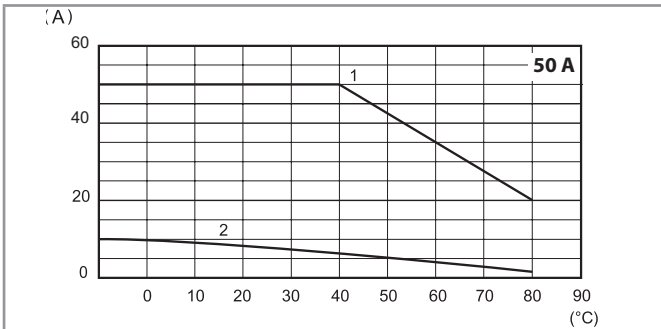

- 1 - Installation on 077.55 heat-sink (0.9 K/W)
- 2 - Installation individually in free-air

L77-3 Inrush peak current (AC) v inrush time
77.01.x.xxx.80xx

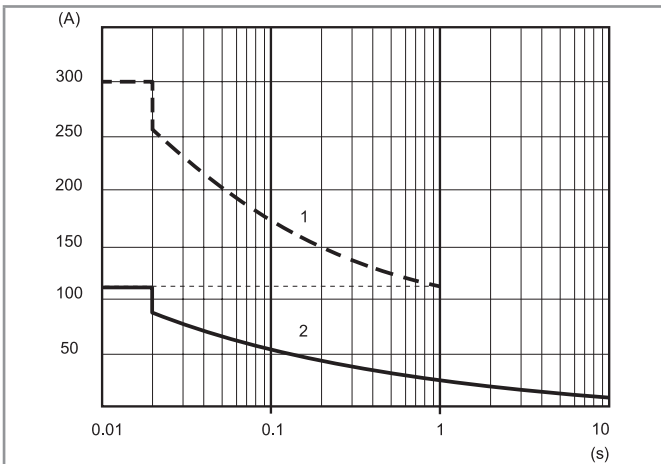

L77-7 Inrush peak current (AC) v inrush time
77.11.x.xxx.82xx

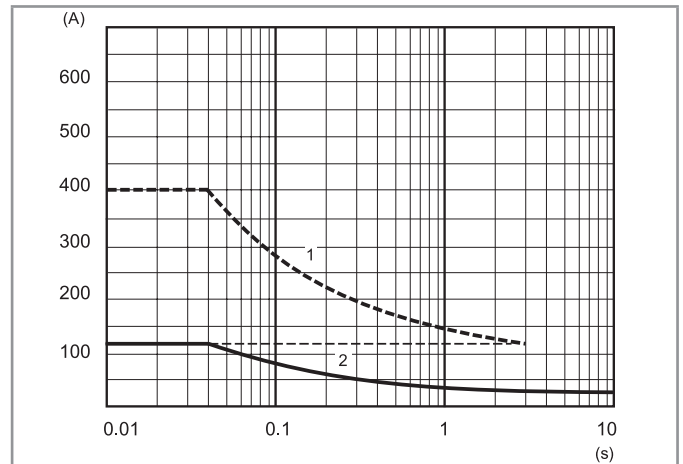

L77-5 Inrush peak current (AC) v inrush time
77.31.x.xxx.80xx

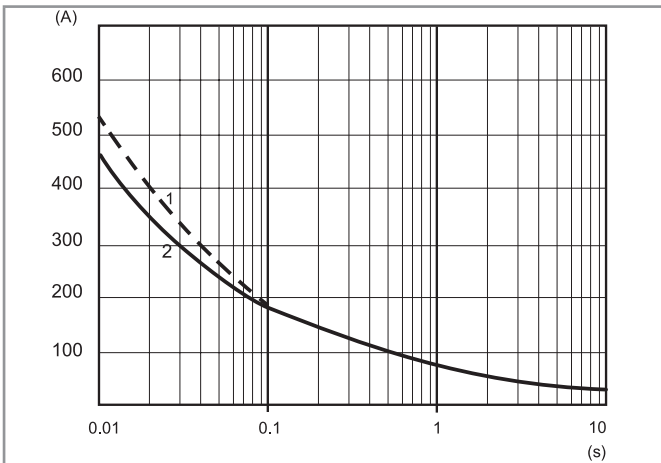

L77-11 Inrush peak current (AC) v inrush time
77x5.x.xxx.8x50

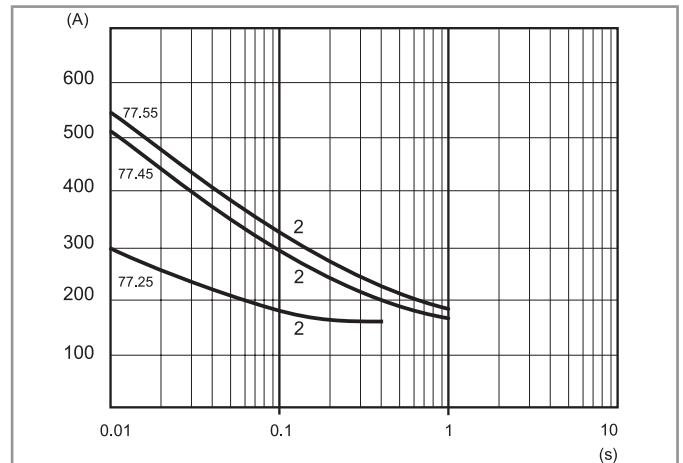

- 1 - "Cold" conditions (ambient temperature = 23 °C, no output current during the last 15 minutes)
- 2 - "Hot" conditions (ambient temperature = 50 °C, rated output current)

Output specification

Max recommended switching frequency (Cycles/Hour, with 50% Duty-cycle)							
Load	77.01.8xxx	77.01.9xxx	77.11	77.31	77.25	77.45	77.55
5 A 230 V (AC1)	5000	—	—	—	—	—	—
5 A 24 V DC L/R = 20 ms	—	3600	—	—	—	—	—
1 A (AC15)	10000	—	—	—	—	—	—
0.5 A (AC15)	20000	—	—	—	—	—	—
15 A 305 V $\cos \varphi = 0.8$	—	—	1800	—	—	—	—
15 A 305 V $\cos \varphi = 0.5$	—	—	1200	—	—	—	—
30 A 480 V $\cos \varphi = 0.8$	—	—	—	1800	—	—	—
30 A 480 V $\cos \varphi = 0.5$	—	—	—	1200	—	—	—
25 A 230 V $\cos \varphi = 0.7$	—	—	—	—	1800	—	—
40 A 230 V $\cos \varphi = 0.7$	—	—	—	—	—	1800	—
50 A 230 V $\cos \varphi = 0.7$	—	—	—	—	—	—	1800

Other data							
	77.01.8xxx	77.01.9xxx	77.11	77.31	77.25	77.45	77.55
Critical rising voltage dv/dt without input control (gate open) @ $T_j = 125^\circ\text{C}$	> 1000 V/ μs	> 1000 V/ μs	> 500 V/ μs > 10 V/ μs (with di/dt = 20 A/ms)	> 1000 V/ μs	300 V/ μs (.8250) 500 V/ μs (.8650)	500 V/ μs (.8250) 1000 V/ μs (.8650)	1000 V/ μs (.8250) 1000 V/ μs (.8650)
Critical rising current di/dt @ $T_j = 125^\circ\text{C}$	> 50 A/ μs	> 50 A/ μs	> 50 A/ μs	> 150 A/ μs	—	—	—
I²t for fusing @ $t_p = 10\text{ ms}$	450 A ² s	450 A ² s	1000 A ² s*	1350 A ² s**	450 A ² s	1250 A ² s	1350 A ² s

Suggested fuse (depending on application) for short-circuit protection (Ultra-Fast acting types for semiconductors):

* 20 A, 660 V AC, 10 x 38 mm, 200 kA, 360 A²s.

** 30 A, 660 V AC, 10 x 38 mm, 200 kA, 1000 A²s.

Wiring diagrams

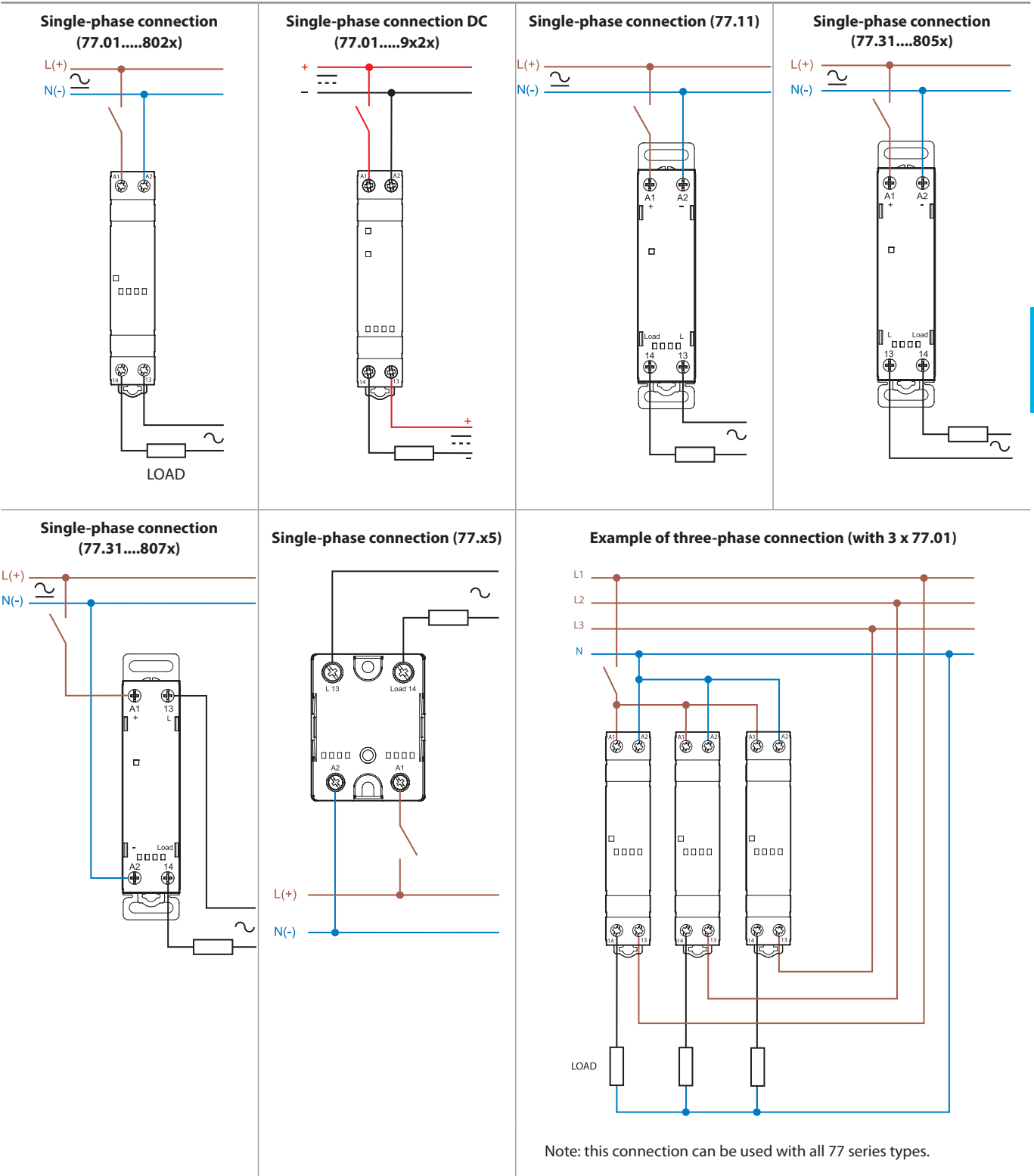

Outline drawings

Type 77.01
Screw terminal

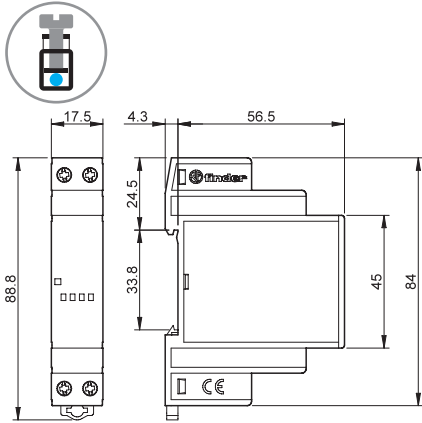

Types 77.11/31
Screw terminal

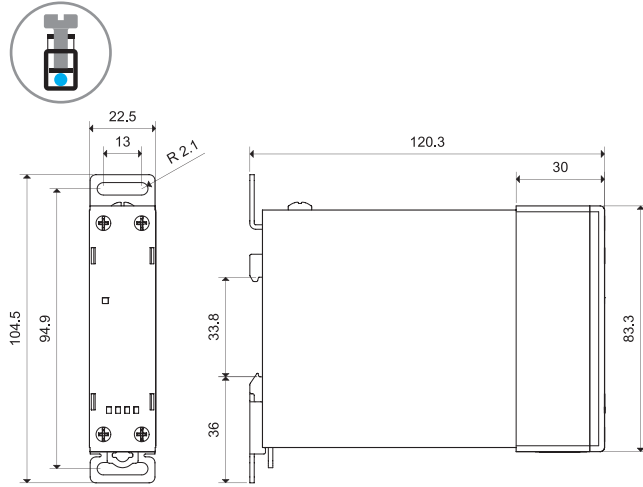

Type 77.01 DC
Screw terminal

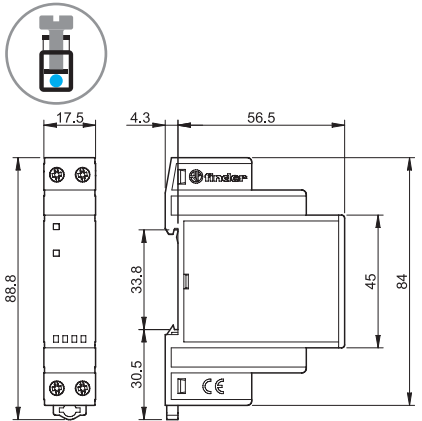

Type 77.x5
Screw terminal (plate clamp)

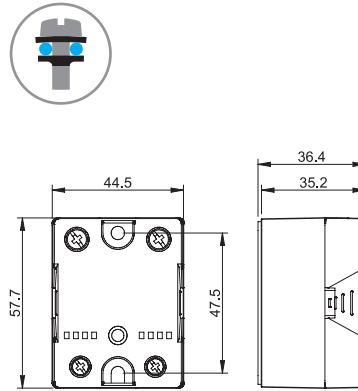

Accessories



Adaptor for panel mounting, plastic, 17.5 mm wide for 77.01 only

020.01

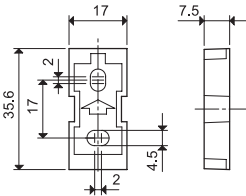

022.09

Separator for rail mounting, plastic, 9 mm wide

022.09

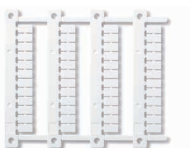
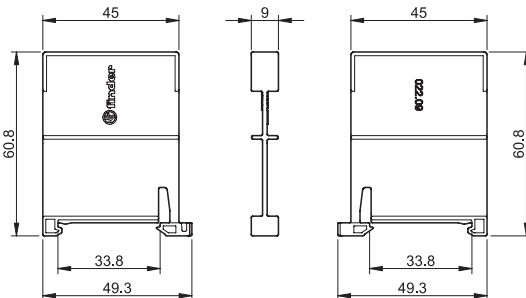

060.48

Sheet of marker tags (CEMBRE Thermal transfer printers) for all relays (48 tags), 6 x 12 mm

060.48

Accessories



077.25

Heat-sink, anodized aluminium, 2 K/W, 65 x 100 mm, for 77.25 only

077.25

- Both the SSR and 35 mm rail clip mount to the heat-sink using M4 screws (supplied with heat-sink)
- Before assembling to the heat-sink, it is necessary to apply a thin and even layer of thermal conductive paste (not supplied) to the lower metal surface of the SSR

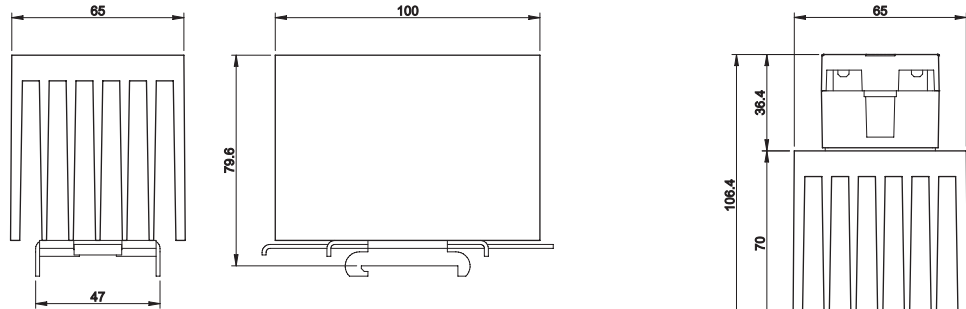

077.25 with 77.25

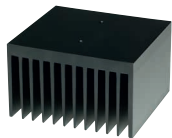

077.55

Heat-sink, anodized aluminium, 0.9 K/W, 111 x 100 mm, for 77.45 and 77.55

077.55

- Both the SSR and 35 mm rail clip mount to the heat-sink using M4 screws (supplied with heat-sink)
- Before assembling to the heat-sink, it is necessary to apply a thin and even layer of thermal conductive paste (not supplied) to the lower metal surface of the SSR

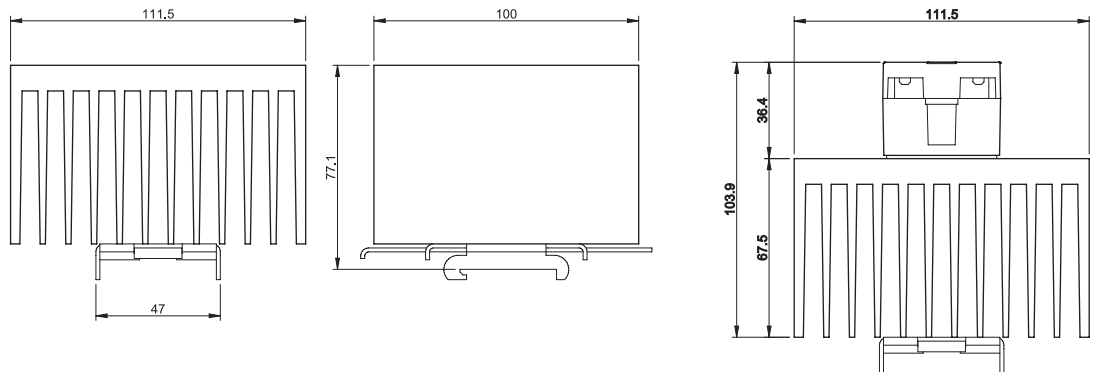

077.55 with 77.45/55

X-ON Electronics

Largest Supplier of Electrical and Electronic Components

Click to view similar products for [Finder manufacturer](#):

Other Similar products are found below :

[013.B9](#) [022.18](#) [022.18.0](#) [022.18.1](#) [022.26](#) [022.26.1](#) [022.33](#) [022.35](#) [022.63](#) [022.65](#) [026.9.012](#) [026.9.024](#) [060.48](#) [066.07](#) [072.01.06](#) [072.01.15](#)
[072.11](#) [072.500](#) [072.501](#) [072.503](#) [072.51](#) [072.53](#) [090.33](#) [092.00.2](#) [092.54](#) [092.71](#) [093.08](#) [093.20](#) [093.20.0](#) [093.20.1](#) [093.48](#) [094.51](#) [094.71](#)
[094.91.3](#) [095.00.4](#) [095.01](#) [095.08](#) [095.18](#) [095.51](#) [095.52](#) [095.71](#) [095.91.3](#) [096.71](#) [097.01](#) [10.41.8.230.0000](#) [10.42.8.230.0000](#)
[10.61.8.230.0000](#) [11.31.0.024.0000](#) [11.31.8.230.0000](#) [11.41.8.230.0000](#)