

# Modular relays with forcibly guided contacts 6 - 10 A



Chemical and  
petrolchemical



Hoists and cranes



Wood-  
processing  
machines



Carousel  
warehouses



Escalators



Elevators  
and lifts



Process  
Industry



Automatic  
car-washes





**Modular relays with forcibly guided contacts**

**Type 7S.12/32**

- 2 pole 6 A (1 NO + 1 NC)

**Type 7S.14/34**

- 4 pole 6 A (2 NO + 2 NC and 3 NO + 1 NC)

**Type 7S.16/36**

- 6 pole 6 A (4 NO + 2 NC)

- For safety applications, with class A forcibly guided contact relays EN 61810-3 (previously EN 50205)
- SIL2 evaluated according to EN 61508, for use in functional safety application according to EN 62061 up to SIL2 and according to IEC 13849-1 up to PL d (instead of For functional reliability in machinery and plant engineering according to EN 13849-1)
- For functional reliability in machinery and plant engineering according to EN 13849-1
- For railway applications; materials compliant with fire and smoke characteristics EN 45545; mechanical and climatic characteristics compliant with EN 61373 and EN 50155
- DC and AC supply versions
- 24 and 110 V DC versions with extended operating range (0.7...1.25)U<sub>N</sub>
- Coil status visual indication with LED
- 35 mm rail (EN 60715) mount

Screwless terminal

Screw terminal



For outline drawing see page 12

**Contact specification**

Contact configuration		1 NO + 1 NC	2 NO + 2 NC, 3 NO + 1 NC	4 NO + 2 NC
Rated current/Max. peak current	A	6/15	6/15	6/15
Rated switching voltage	V AC (50/60 Hz)	250	250	250
Rated load AC1	VA	1500	1500	1500
Rated current AC15 (230 V AC)	A	3	3	3
Rated current AC15 (400 V AC)	A	2	—	—
Breaking capacity DC1: 30/110/220 V	A	6/0.6/0.2	6/0.9/0.3	6/0.9/0.3
Breaking capacity DC13: 24 V	A	1	3	3
Minimum switching load	mW (V/mA)	60 (5/5)	60 (5/10)	60 (5/10)
Standard contact material		AgNi + Au	AgSnO <sub>2</sub>	AgSnO <sub>2</sub> +Au

**Coil specification**

Nominal voltage (U <sub>N</sub> )	V AC (50/60 Hz)	110...125 - 230...240	110...125 - 230...240	110...125 - 230...240
	V DC	12 - 24	12 - 24 - 110	12 - 24 - 110
Rated power	VA (50 Hz)/W	2.3/1	2.3/1	2.3/1
Operating range	AC	(0.85...1.1)U <sub>N</sub>	(0.85...1.1)U <sub>N</sub>	(0.85...1.1)U <sub>N</sub>
	DC	(0.8...1.2)U <sub>N</sub>	(0.8...1.2)U <sub>N</sub>	(0.8...1.2)U <sub>N</sub>
	DC extended range (24 and 110 V only)	(0.7...1.25)U <sub>N</sub>	(0.7...1.25)U <sub>N</sub>	(0.7...1.25)U <sub>N</sub>
Holding voltage	AC/DC	0.45 U <sub>N</sub> / 0.45 U <sub>N</sub>	0.55 U <sub>N</sub> / 0.55 U <sub>N</sub>	0.55 U <sub>N</sub> / 0.55 U <sub>N</sub>
Must drop-out voltage	AC/DC	0.1 U <sub>N</sub> / 0.1 U <sub>N</sub>	0.1 U <sub>N</sub> / 0.1 U <sub>N</sub>	0.1 U <sub>N</sub> / 0.1 U <sub>N</sub>

**Technical data**

Mechanical life	cycles	10 · 10 <sup>6</sup>	10 · 10 <sup>6</sup>	10 · 10 <sup>6</sup>
Electrical life at rated load AC1	cycles	100 · 10 <sup>3</sup>	100 · 10 <sup>3</sup>	100 · 10 <sup>3</sup>
Operate/release time	ms	7/11	12/10	12/10
Insulation between coil and contacts (1.2/50 μs)	kV	6	6	6
Dielectric strength between open contacts	V AC	1500	1500	1500
Ambient temperature	°C	-40...+70	-40...+70	-40...+70
Protection category		IP 20	IP 20	IP 20

**Approvals** (according to type)



**7S.12/32...5110** NEW



• 2 pole (1 NO + 1 NC)

**7S.14/34...4xx0** NEW



• 4 pole :  
(2 NO + 2 NC) type  
7S.xx.x.xxx.4220  
(3 NO + 1 NC) type  
7S.xx.x.xxx.4310

**7S.16/36...5420** NEW



• 6 pole (4 NO + 2 NC)

**Modular relays with forcibly guided contacts**
**Type 7S.23**

- 3 pole (2 NO + 1 NC)

- For safety applications, with class A forcibly guided contact relays EN 61810-3 (previously EN 50205)
- SIL2 evaluated according to EN 61508, for use in functional safety application according to EN 62061 up to SIL2 and according to IEC 13849-1 up to PL d (instead of For functional reliability in machinery and plant engineering according to EN 13849-1)
- For functional reliability in machinery and plant engineering according to EN 13849-1
- DC coil
- Cadmium free contacts
- 17.5 mm wide
- Coil status visual indication with LED
- 35 mm rail (EN 60715) mount

Screw terminal

**7S.23**
**NEW**

- 3 pole (2 NO + 1 NC)

For outline drawing see page 12

**Contact specification**

Contact configuration		2 NO + 1 NC
Rated current/Max. peak current	A	10/20
Rated switching voltage	V AC (50/60 Hz)	250
Rated load AC1	VA	2500
Rated current AC15 (230 V AC)	A	5
Breaking capacity DC1: 30/110/220 V	A	6/0.6/0.2
Breaking capacity DC13: 24 V	A	5
Minimum switching load	mW (V/mA)	60 (5/5)
Standard contact material		AgNi + Au

**Coil specification**

Nominal voltage ( $U_N$ )	V DC	12 - 24 - 48 - 110
Rated power	W	1
Operating range	DC	(0.8...1.2) $U_N$
Holding voltage	DC	0.45 $U_N$
Must drop-out voltage	DC	0.1 $U_N$

**Technical data**

Mechanical life	cycles	$10 \cdot 10^6$
Electrical life at rated load AC1	cycles	$100 \cdot 10^3$
Operate/release time	ms	7/11
Insulation between coil and contacts (1.2/50 $\mu$ s)	kV	6
Dielectric strength between open contacts	V AC	1500
Ambient temperature	$^{\circ}$ C	-40...+70
Protection category		IP 20

**Approvals** (according to type)

**Modular relays with forcibly guided contacts for SIL3 safety applications**

**Type 7S.43/63**

- 2 NO safety contacts
- 1 NC feedback contact
- 1 auxiliary signalling contact
- For safety application, with class A forcibly guided contact relays EN 61810-3 (previously EN 50205) for safety application up to SIL 3
- SIL 3 evaluated according to EN 61508, for use in functional safety application according to EN 62061 up to SIL 3 and according to IEC 13849-1 up to PL e
- Double channel architecture (1oo2) with 2 NO contact, 1 feedback contact and 1 auxiliary contact
- From 12 up to 110 V DC version with operating range  $(0.85 \dots 1.1)U_N$
- Coil status visual indication with LED
- 35 mm rail (EN 60715) mount

Screwless terminal

Screw terminal



**7S.43/63...0211** NEW



- 3 pole (2 NO + 1 NC)
- 1 auxiliary contact

For outline drawing see page 12

Contact specification		
Contact configuration		2 NO + 1 NC + 1 AUX
Rated current/Max. peak current	A	6/15
Rated switching voltage	V AC (50/60 Hz)	250
Rated load AC1	VA	1500
Rated current AC15 (230 V AC)	A	3
Breaking capacity DC1: 30/110/220 V	A	6/0.6/0.2
Breaking capacity DC13: 24 V	A	3
Minimum switching load	mW (V/mA)	60 (5/10)
Standard contact material		AgSnO <sub>2</sub> & AgNi+Au
Coil specification		
Nominal voltage (U <sub>N</sub> )	V DC	12 - 24 - 48 - 110
Rated power	W	1.7
Operating range	DC	$(0.85 \dots 1.1)U_N$
Holding voltage	DC	0.55 U <sub>N</sub>
Must drop-out voltage	DC	0.1 U <sub>N</sub>
Technical data		
Mechanical life	cycles	10 · 10 <sup>6</sup>
Electrical life at rated load AC1	cycles	100 · 10 <sup>3</sup>
Operate/release time of NO contacts	ms	10/7
Operate/release time of NC contacts	ms	5/30
Insulation between coil and contacts (1.2/50 μs)	kV	6
Dielectric strength between open contacts	V AC	1500
Ambient temperature	°C	-40...+70
Protection category		IP 20
<b>Approvals</b> (according to type)		

## Ordering information

Example: 7S series Modular relay with forcibly guided contacts, 6 contact (4 NO + 2 NC) 6 A, supply voltage 24 V DC.

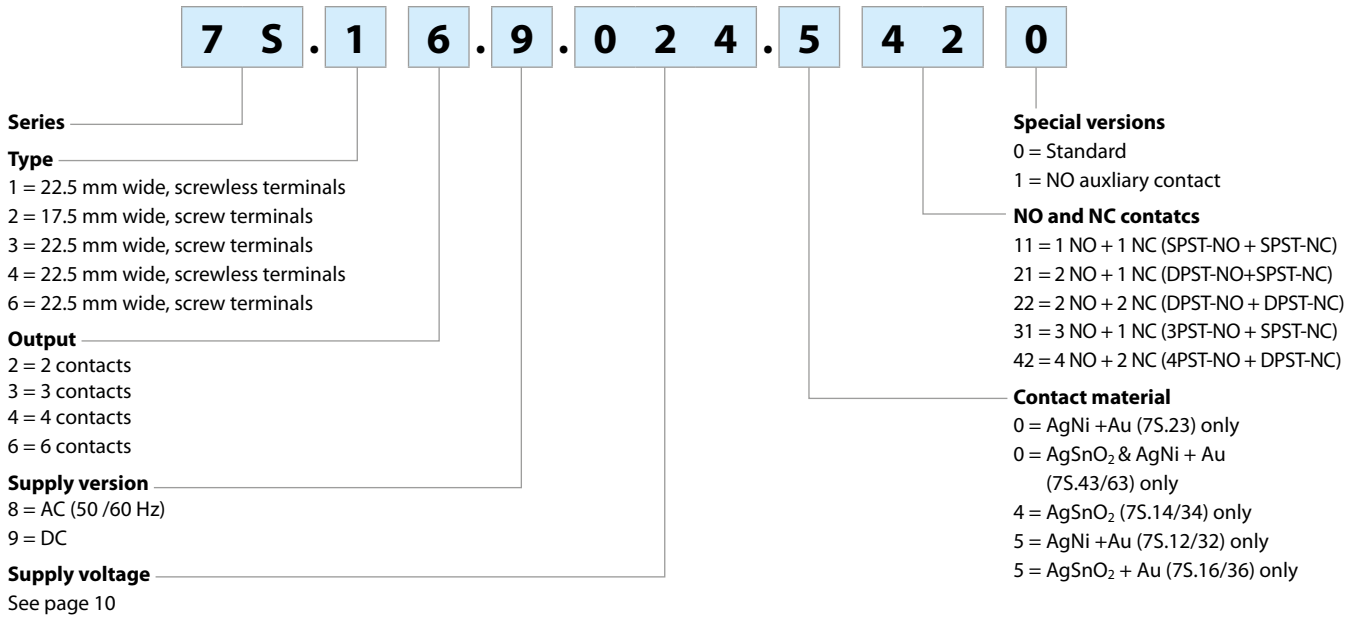

**Codes**, Preferred selections for best availability are shown in **bold**.

7S.12.9.012.5110	7S.14.9.012.4220	7S.16.9.012.5420
<b>7S.12.9.024.5110</b>	7S.14.9.012.4310	<b>7S.16.9.024.5420</b>
7S.12.8.120.5110	<b>7S.14.9.024.4220</b>	7S.16.9.110.5420
7S.12.8.230.5110	<b>7S.14.9.024.4310</b>	7S.16.8.120.5420
	7S.14.9.110.4220	7S.16.8.230.5420
7S.32.9.012.5110	7S.14.9.110.4310	
<b>7S.32.9.024.5110</b>	7S.14.8.120.4220	7S.36.9.012.5420
7S.32.8.120.5110	7S.14.8.120.4310	<b>7S.36.9.024.5420</b>
7S.32.8.230.5110	7S.14.8.230.4220	7S.36.9.110.5420
	7S.14.8.230.4310	7S.36.8.120.5420
		7S.36.8.230.5420
7S.43.9.012.0211		
<b>7S.43.9.024.0211</b>	7S.34.9.012.4220	
7S.43.9.048.0211	7S.34.9.012.4310	7S.23.9.012.0210
7S.43.9.110.0211	<b>7S.34.9.024.4220</b>	<b>7S.23.9.024.0210</b>
	<b>7S.34.9.024.4310</b>	7S.23.9.048.0210
7S.63.9.012.0211	7S.34.9.110.4220	7S.23.9.110.0210
<b>7S.63.9.024.0211</b>	7S.34.9.110.4310	
7S.63.9.048.0211	7S.34.8.120.4220	
7S.63.9.110.0211	7S.34.8.120.4310	
	7S.34.8.230.4220	
	7S.34.8.230.4310	

## Technical data

Insulation according to EN 61810-1		
Nominal voltage of supply system	V AC	230/400
Rated insulation voltage	V AC	250
Pollution degree		2
Insulation between coil and contact set		
Type of Insulation		Reinforced
Overtoltage category		III
Rated impulse voltage	kV (1.2/50 μs)	6
Dielectric strength	V AC	4000
Insulation between adjacent contacts		
Type of Insulation		Basic
Overtoltage category		III
Rated impulse voltage	kV (1.2/50 μs)	4
Dielectric strength	V AC	2500
Insulation between open contacts		
Type of disconnection		Micro-disconnection
Dielectric strength	V AC/kV (1.2/50 μs)	1500/2.5

Insulation between coil terminals						
Rated impulse voltage (surge) differential mode (according to EN 61000-4-5)	kV (1.2/50 μs)	1.5				
Terminals		Screw Terminal		Screwless Terminal		
Min. wire size		solid cable	stranded cable	solid cable	stranded cable	
	mm <sup>2</sup>	0.5	0.5	0.5	0.5	
	AWG	21	21	21	21	
		Screw Terminal		Screwless Terminal		
Max. wire size		solid cable	stranded cable	solid cable	stranded cable	
	mm <sup>2</sup>	1 x 6 / 2 x 2.5	1 x 4 / 2 x 2.5	1 x 1.5	1 x 1.5	
	AWG	1 x 10 / 2 x 14	1 x 12 / 2 x 14	1 x 14	1 x 16	
Wire strip length	mm	9				
Other data		7S.12/32	7S.14/34	7S.16/36	7S.23	7S.43/63
Bounce time: NO/NC	ms	2/8	2/10	2/10	2/15	1/8
Vibration resistance (10...200)Hz: NO/NC	g	10/5	20/6	20/6	10/2	10/2
Shock resistance: NO/NC	g	20/6	20/5	20/5	20/6	20/5
Power lost to the environment	without contact current	W	0.8	0.8	0.8	1.7
	with rated current	W	1.4	2.3	2.8	3.8

## Contact specifications

### Contact diagrams

7S.12/7S.32

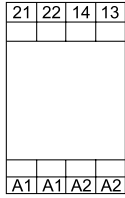
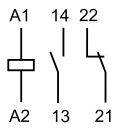

7S.14/34...4220

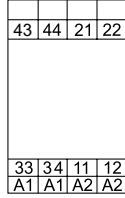
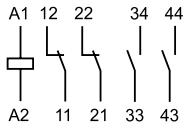

7S.14...4310

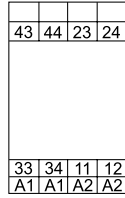
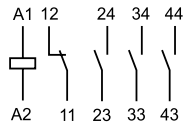

7S.16/36...5420

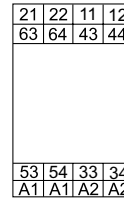
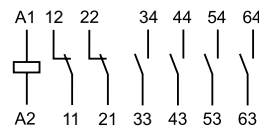

7S.23

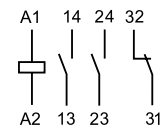

7S.43/7S.63

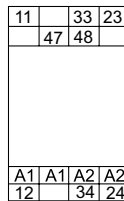
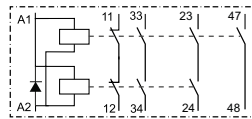

F 7S12 - Electrical life (AC) v contact current - 7S.12

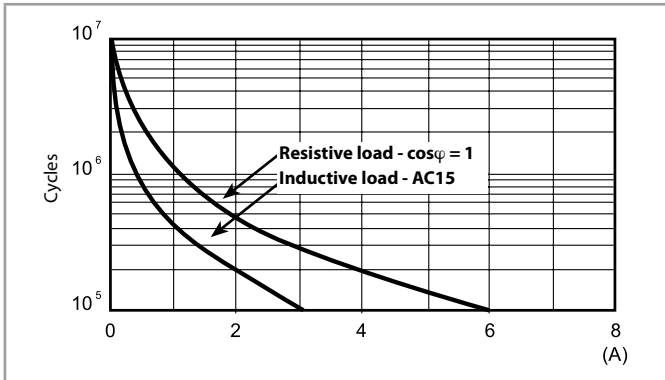

H 7S12\* - Maximum DC breaking capacity - 7S.12

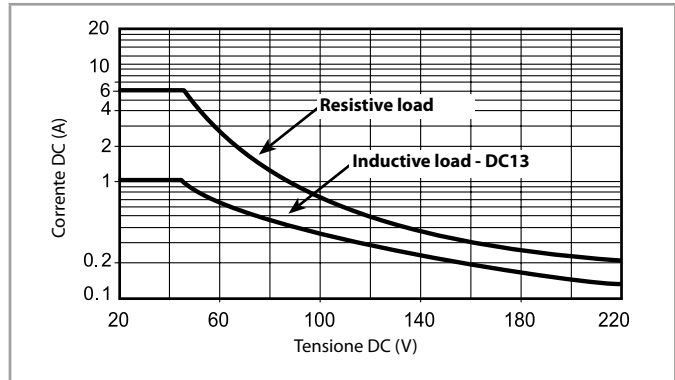

F 7S14 - Electrical life (AC) v contact current - 7S.14/34

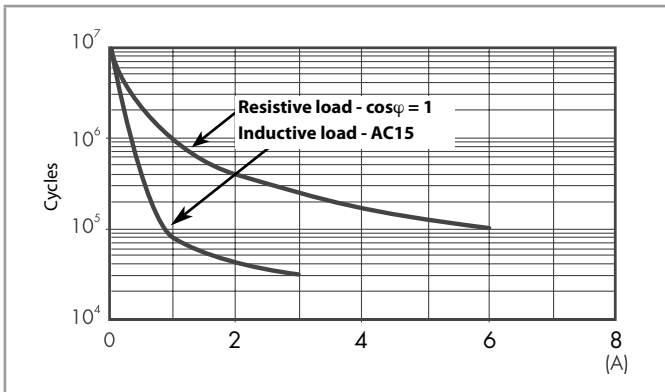

H 7S14\* - Maximum DC breaking capacity - 7S.14/34

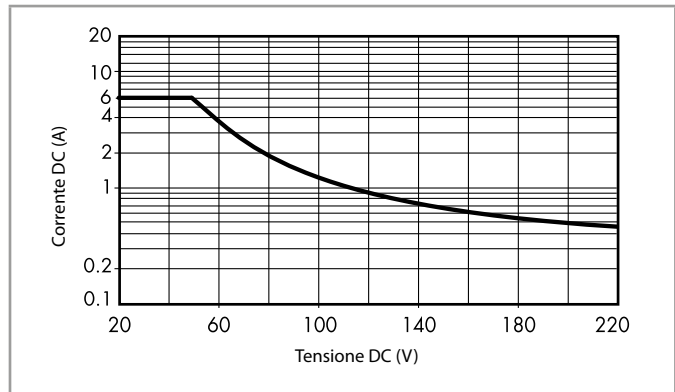

\* When switching a load having voltage and current values under the curve, an electrical life of  $\geq 100 \cdot 10^3$  can be expected.



### Contact specifications

**F 7S16 - Electrical life (AC) v contact current - 7S.16/36**

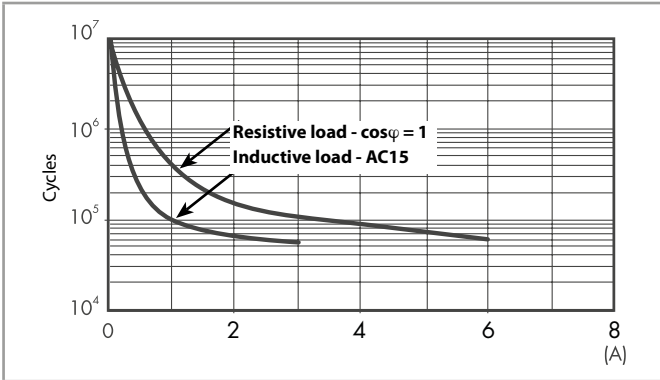

**H 7S16\* - Maximum DC breaking capacity - 7S.16/36**

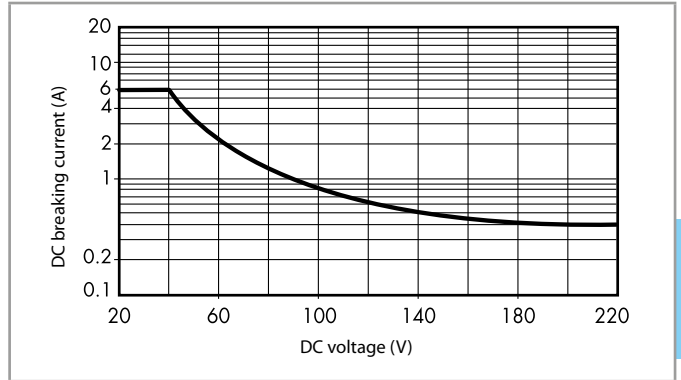

**F 7S23 - Electrical life (AC) v contact current - 7S.23**

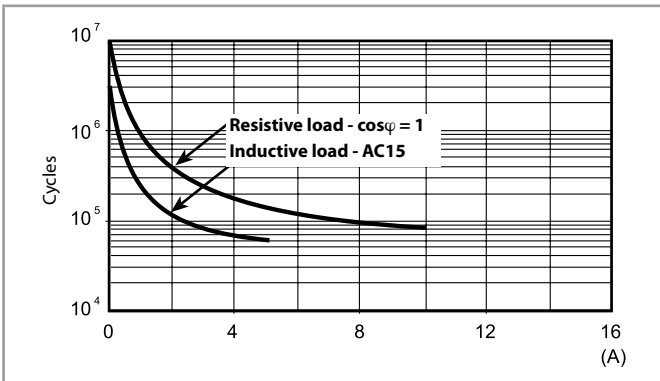

**H 7S23\* - Maximum DC breaking capacity - 7S.23**

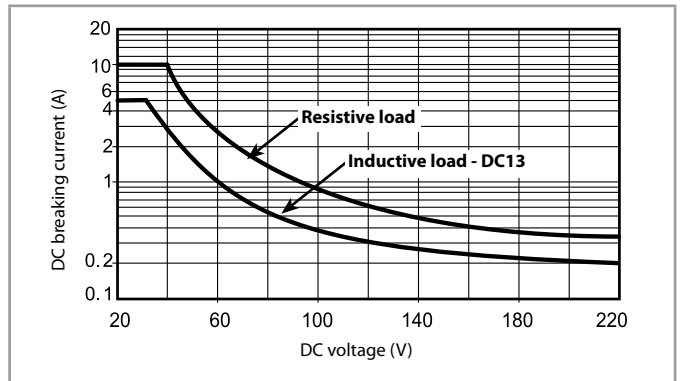

**F 7S43 - Electrical life (AC) v contact current - 7S.43/63**

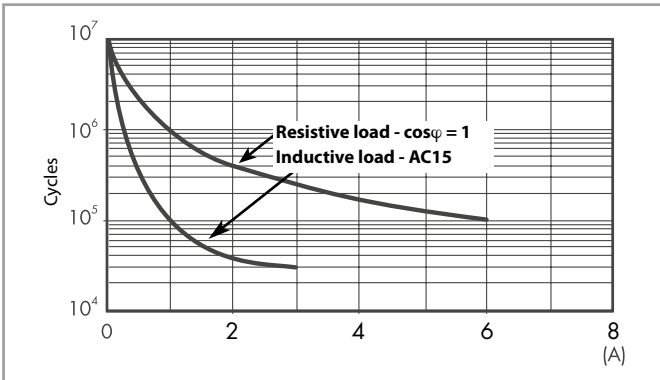

**H 7S43\* - Maximum DC breaking capacity - 7S.43/63**

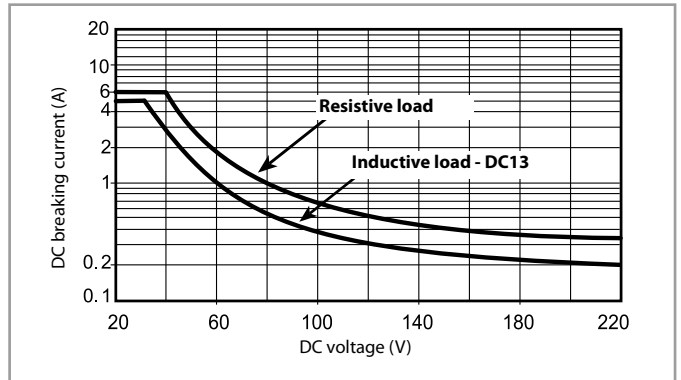

\* When switching a load having voltage and current values under the curve, an electrical life of  $\geq 100 \cdot 10^3$  can be expected.

### Coil specifications

#### DC coil data - type 7S.12/32

Nominal voltage	Coil code	Operating range		Rated input current at $U_N$	Rated power at $U_N$
		$U_{min}$	$U_{max}$		
$U_N$		V	V	$I_N$	W
V		V	V	mA	W
12	9.012	9.6	14.4	55	0.7
24	9.024	16.8	30	38.2	0.9

#### AC coil data - type 7S.12/32

Nominal voltage	Coil code	Operating range		Rated input current at $U_N$	Rated power at $U_N$
		$U_{min}$	$U_{max}$		
$U_N$		V	V	$I_N$	VA/W
V		V	V	mA	VA/W
110...125	8.120	93	138	9.8	1.2/1.1
230...240	8.230	195	264	11.8	2.8/1.2

#### DC coil data - type 7S.14/34 / 7S.16/36

Nominal voltage	Coil code	Operating range		Rated input current at $U_N$	Rated power at $U_N$
		$U_{min}$	$U_{max}$		
$U_N$		V	V	$I_N$	W
V		V	V	mA	W
12	9.012	9.6	14.4	64.7	0.8
24	9.024	16.8	30	42.2	1
110	9.110	77	138	11.6	1.4

#### AC coil data - type 7S.14/34 / 7S.16/36

Nominal voltage	Coil code	Operating range		Rated input current at $U_N$	Rated power at $U_N$
		$U_{min}$	$U_{max}$		
$U_N$		V	V	$I_N$	VA/W
V		V	V	mA	VA/W
110...125	8.120	93	138	10.2	1.3/1.1
230...240	8.230	195	264	11.8	2.9/1.2

#### DC coil data - type 7S.23

Nominal voltage	Coil code	Operating range		Rated input current at $U_N$	Rated power at $U_N$
		$U_{min}$	$U_{max}$		
$U_N$		V	V	$I_N$	W
V		V	V	mA	W
12	9.012	9.6	14.4	47.1	0.6
24	9.024	16.8	30	26.6	0.6
48	9.048	33.6	60	16.2	0.8
110	9.110	77	138	8.8	1

#### DC coil data - type 7S.43/63

Nominal voltage	Coil code	Operating range		Rated input current at $U_N$	Rated power at $U_N$
		$U_{min}$	$U_{max}$		
$U_N$		V	V	$I_N$	W
V		V	V	mA	W
12	9.012	10.2	13.2	105	1.3
24	9.024	20.4	26.4	60	1.45
48	9.048	40.8	52.8	36	1.6
110	9.110	93.5	121	20	1.7

#### R 7S - DC coil operating range v ambient temperature - 7S.12/32 / 7S.23 / 7S.14/34 / 7S.16/36

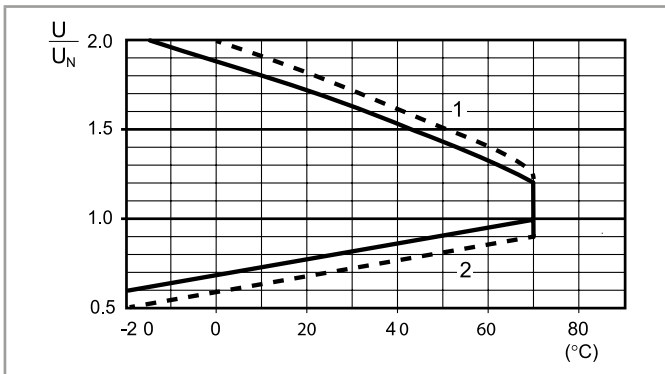

- 1 - Max. permitted coil voltage.
- 2 - Min. pick-up voltage with coil at ambient temperature.
- 24 and 110 V DC coils only (extended range) excluding 7S.23

#### R 7S - AC coil operating range v ambient temperature - 7S.12/32 / 7S.14/34 / 7S.16/36

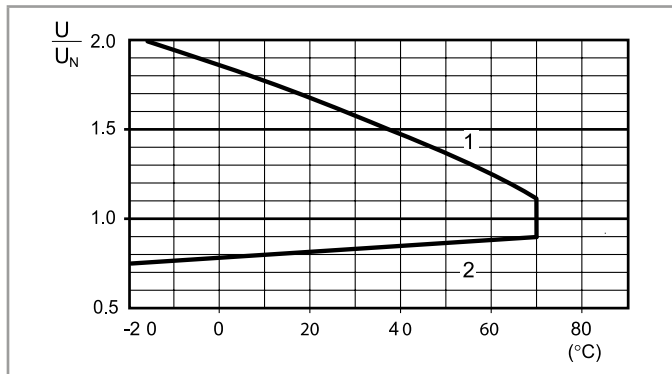

- 1 - Max. permitted coil voltage.
- 2 - Min. pick-up voltage with coil at ambient temperature.

#### R 7S - DC coil operating range v ambient temperature - 7S.43/63

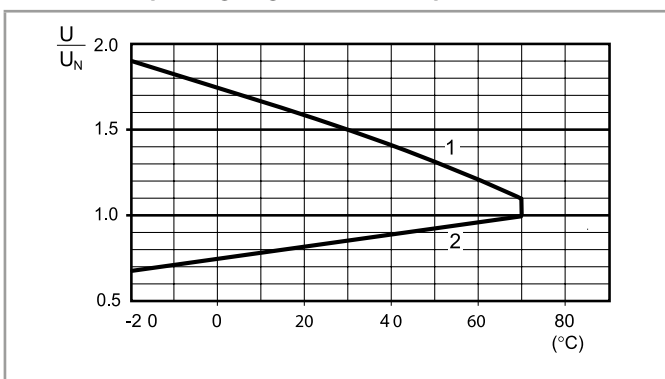

- 1 - Max. permitted coil voltage.
- 2 - Min. pick-up voltage with coil at ambient temperature.



### Outline drawings

Types 75.12/14/16/43  
Screwless terminal

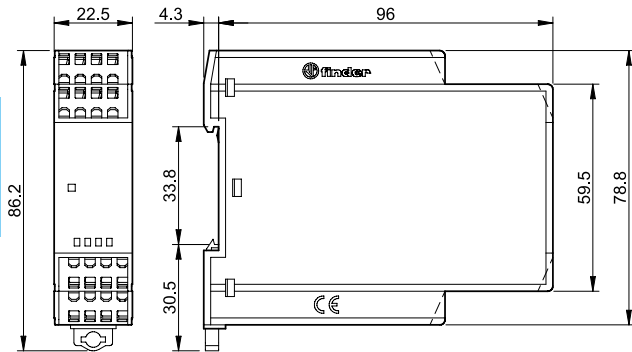

Type 75.23  
Screw terminal

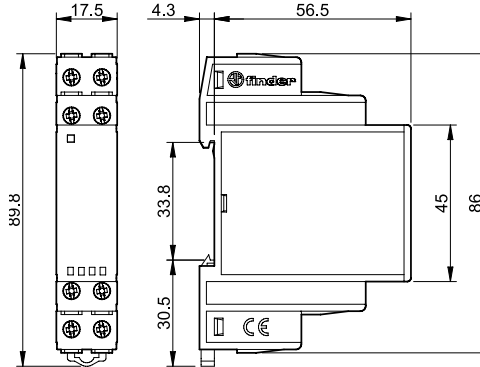

Type 75.32  
Screw terminal

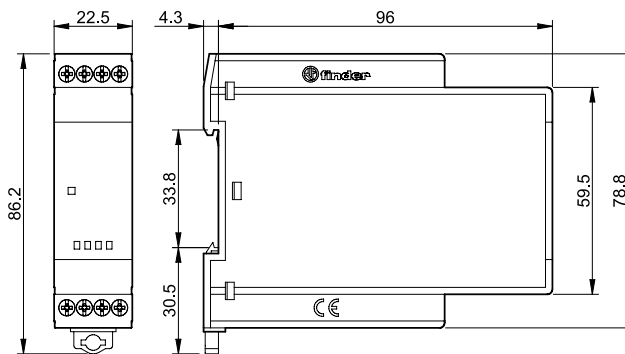

Type 75.34  
Screw terminal

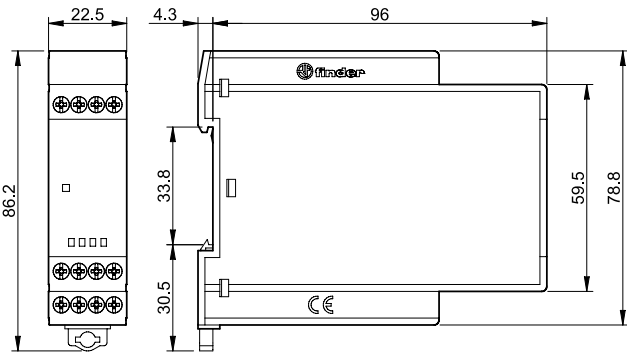

Type 75.36  
Screw terminal

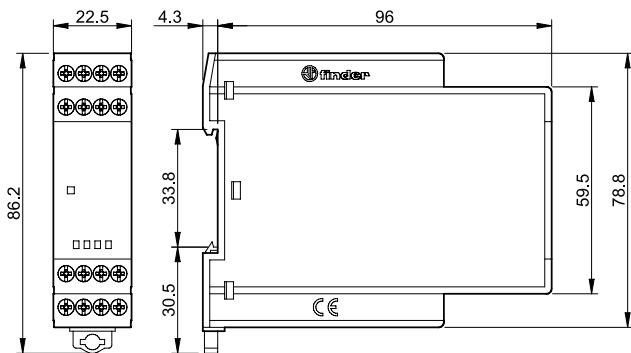

Type 75.63  
Screw terminal

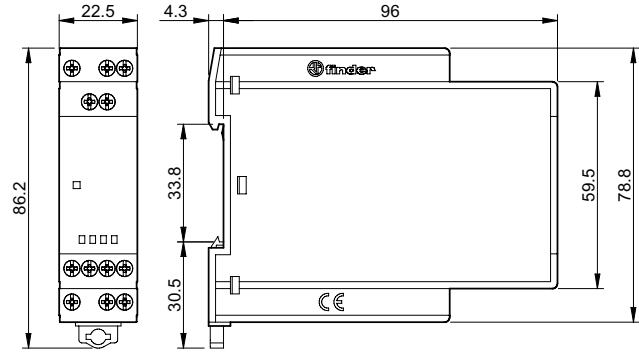

### Accessories

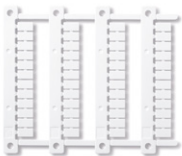

060.48

Sheet of marker tags, plastic, 48 tags, 6 x 12 mm, for CEMBRE thermal transfer printers

060.48

## X-ON Electronics

Largest Supplier of Electrical and Electronic Components

*Click to view similar products for [Safety Relays](#) category:*

*Click to view products by [Finder](#) manufacturer:*

Other Similar products are found below :

[7-1618103-5](#) [1351-1X](#) [1618082-4](#) [1618111-1](#) [C200HDA003](#) [C200HMR432](#) [C200HMR832](#) [C200HMR833](#) [C28PEDRA](#) [20-050-36X](#)  
[C500ETL01](#) [C500OD415CN](#) [2-1618068-0](#) [9-1618103-2](#) [SP10-ETL01](#) [C200HOD214](#) [C500CN812N](#) [4NK0AQY](#) [1100-42X](#)  
[V23050A1012A551](#) [6-1618082-4](#) [7-1618103-6](#) [WTD-101X](#) [SP16DRD](#) [SP16DRA](#) [C500-IDS02-V1](#) [607.5111.020](#) [DOLD 48173](#) [750136](#)  
[600PSR-165/300-CU](#) [J73KN-AM-22](#) [G7SA-3A1B DC12](#) [SR6V6K18](#) [PSR-SCP- 24UC/ESL4/3X1/1X2/B](#) [2TLA010033R3000](#)  
[2TLA010033R2000](#) [2TLA010017R0100](#) [7S.32.9.024.5110](#) [7S.34.9.024.4220](#) [7S.34.9.110.4220](#) [HA1E-AC12V](#) [V23050A1012A533](#) [774300](#)  
[774303](#) [774310](#) [774318](#) [774060](#) [2-1415055-1](#) [774131](#) [SR4D4018](#)