



finder[®]
SWITCH TO THE FUTURE

SERIE
7S

Modular relays with forcibly guided contacts 6 A



Chemical and
petrolchemical



Hoists and cranes



Wood-
processing
machines



Carousel
warehouses



Escalators



Elevators
and lifts



Process
Industry



Automatic
car-washes

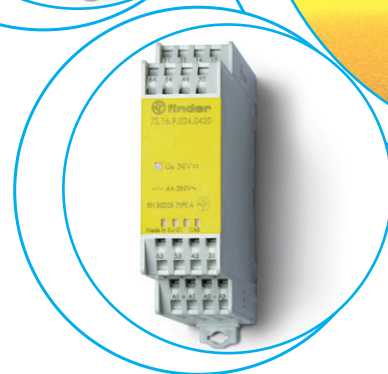
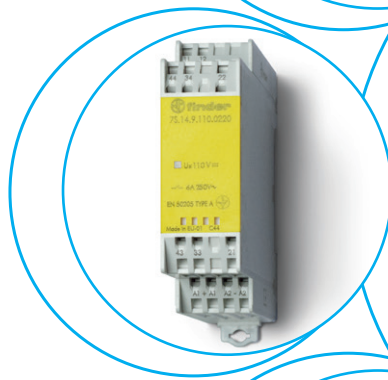

Relay module with forcibly guided contacts

- 7S.12 with 2 pole (1NO + 1 NC)
- 7S.14 with 4 pole (2 NO + 2 NC and 3 NO + 1 NC)
- 7S.16 with 6 pole (4 NO + 2 NC)

- For safety applications, with class A forcibly guided contact relays (EN 50205)
- For applications up to SIL 2 according to IEC 61508
- For functional reliability in machinery and plant engineering according to EN 13849-1
- For railway applications; materials compliant with fire and smoke characteristics (UNI 11170-3); mechanical and climatic characteristics compliant with EN 61373 and EN 50155
- DC and AC supply versions
- 24 and 110 V DC versions with extended operating range (0.7...1.25)U_N
- Coil status visual indication with LED
- 35 mm rail (EN 60715) mount

Screwless terminal



* Single contact current ≤ 6 A,
total NO contacts current ≤ 12 A

For outline drawing see page 8

Contact specification

	1 NO + 1 NC	2 NO + 2 NC, 3 NO + 1 NC	4 NO + 2 NC
Contact configuration	1 NO + 1 NC	2 NO + 2 NC, 3 NO + 1 NC	4 NO + 2 NC
Rated current/Max. peak current	A 6/15	6*/12	6*/12
Rated switching voltage	V AC (50/60 Hz) 250	250	250
Rated load AC1	VA 1500	1500	1500
Rated load AC15 (230 V AC)	VA 700	500	500
Breaking capacity DC1: 30/110/220 V	A 6/0.6/0.2	6/0.6/0.3	6/0.6/0.3
Breaking capacity DC13: 24 V	A 1	1	1
Minimum switching load	mW (V/mA) 60 (5/5)	60 (5/5)	60 (5/5)
Standard contact material	AgNi + Au	AgNi with notched crown	AgNi with notched crown

Coil specification

	110...125 - 230...240	110...125 - 230...240	110...125 - 230...240
Nominal voltage (U _N)	V AC (50/60 Hz)	V DC	V DC
Rated power	VA (50 Hz)/W 2.3/1	2.3/1	2.3/1
Operating range	AC (0.85...1.1)U _N	(0.85...1.1)U _N	(0.85...1.1)U _N
	DC (0.8...1.2)U _N	(0.8...1.2)U _N	(0.8...1.2)U _N
	DC extended range (24 and 110 V only) (0.7...1.25)U _N	(0.7...1.25)U _N	(0.7...1.25)U _N
Holding voltage	AC/DC 0.45 U _N / 0.45 U _N	0.55 U _N / 0.55 U _N	0.55 U _N / 0.55 U _N
Must drop-out voltage	AC/DC 0.1 U _N / 0.1 U _N	0.1 U _N / 0.1 U _N	0.1 U _N / 0.1 U _N

Technical data

Mechanical life	cycles 10 · 10 ⁶	10 · 10 ⁶	10 · 10 ⁶
Electrical life at rated load AC1	cycles 100 · 10 ³	100 · 10 ³	100 · 10 ³
Operate/release time	ms 7/11	12/10	12/10
Insulation between coil and contacts (1.2/50 μs)	kV 6	6 (4 against 13-14)	6 (4 against 13-14)
Dielectric strength between open contacts	V AC 1500	1500	1500
Ambient temperature	°C -40...+70	-40...+70	-40...+70
Protection category	IP 20	IP 20	IP 20

Approvals (according to type)



**Relay module with forcibly guided contacts
7S.23 with 3 pole (2NO + 1 NC)**

- For safety applications, with class A forcibly guided contact relays (EN 50205)
- For functional reliability in machinery and plant engineering according to EN 13849-1
- DC coil
- Damium free contacts
- 17.5 mm wide
- Coil status visual indication with LED
- 35 mm rail (EN 60715) mount



- 3 pole (2 NO + 1 NC)

Screw terminal



For outline drawing see page 7

Contact specification

Contact configuration		2 NO + 1 NC
Rated current/Max. peak current	A	10/20
Rated switching voltage	V AC (50/60 Hz)	250
Rated load AC1	VA	2500
Rated load AC15 (230 V AC)	VA	500
Breaking capacity DC1: 30/110/220 V	A	6/0.6/0.2
Breaking capacity DC13: 24 V	A	1
Minimum switching load	mW (V/mA)	60 (5/5)
Standard contact material		AgNi + Au

Coil specification

Nominal voltage (U _N)	V DC	12 - 24 - 48 - 110
Rated power	VA (50 Hz)/W	2.3/1
Operating range	DC	(0.8...1.2)U _N
Holding voltage	DC	0.45 U _N
Must drop-out voltage	DC	0.1 U _N

Technical data

Mechanical life	cycles	10 · 10 ⁶
Electrical life at rated load AC1	cycles	100 · 10 ³
Operate/release time	ms	7/11
Insulation between coil and contacts (1.2/50 μs)	kV	6
Dielectric strength between open contacts	V AC	1500
Ambient temperature	°C	-40...+70
Protection category		IP 20

Approvals (according to type)

Ordering information

Example: 7S series Relay module with forcibly guided contacts, 6 contact (4 NO + 2 NC) 6 A, supply voltage 24 V DC.

7 S . 1 6 . 9 . 0 2 4 . 0 4 2 0

Series

Type

- 1 = 22.5 mm wide, screwless terminals
- 2 = 17.5 mm wide, screw terminals

Output

- 2 = 2 contacts
- 3 = 3 contacts
- 4 = 4 contacts
- 6 = 6 contacts

Supply version

- 8 = AC (50 /60 Hz)
- 9 = DC

Supply voltage

See page 6

Special versions

0 = Standard

NO and NC contacts

- 11 = 1 NO + 1 NC
- 21 = 2 NO + 1 NC
- 22 = 2 NO + 2 NC
- 31 = 3 NO + 1 NC
- 42 = 4 NO + 2 NC

Contact material

- 0 = AgNi
- 0 = AgNi+Au (7S.23)
- 5 = AgNi + Au

Codes, Preferred selections for best availability are shown in **bold**.

7S.12.9.012.5110	7S.14.9.012.0220	7S.16.9.012.0420
7S.12.9.024.5110	7S.14.9.012.0310	7S.16.9.024.0420
7S.12.8.120.5110	7S.14.9.024.0220	7S.16.9.110.0420
7S.12.8.230.5110	7S.14.9.024.0310	7S.16.8.120.0420
	7S.14.9.110.0220	7S.16.8.230.0420
	7S.14.9.110.0310	7S.23.9.012.0210
	7S.14.8.120.0220	7S.23.9.024.0210
	7S.14.8.120.0310	7S.23.9.048.0210
	7S.14.8.230.0220	7S.23.9.110.0210
	7S.14.8.230.0310	



Technical data

Insulation according to EN 61810-1

Nominal voltage of supply system	V AC	230/400
Rated insulation voltage	V AC	250
Pollution degree		2

Insulation between coil and contact set

Type of Insulation		Reinforced*	Basic*	Reinforced*
Overvoltage category		III	III	II
Rated impulse voltage	kV (1.2/50 μs)	6	4	4
Dielectric strength	V AC	4000	2500	2500

Insulation between adjacent contacts

Type of Insulation		Reinforced*	Basic*	Reinforced*
Overvoltage category		III	III	II
Rated impulse voltage	kV (1.2/50 μs)	6	4	4
Dielectric strength	V AC	4000	2500	2500

Insulation between open contacts

Type of disconnection		Micro-disconnection
Dielectric strength	V AC/kV (1.2/50 μs)	1500/2.5

* Tables below indicate, for each 7S type, those contacts (R) meeting Reinforced Insulation Overvoltage category III, those contacts (R2) meeting Reinforced Insulation Overvoltage category II, and those contacts (B) meeting Basic Insulation Overvoltage category III.

EMC specifications		Reference standard		
Burst (5/50 ns)	on supply terminals	EN 61000-4-4	4 kV	
Surge (1.2/50 μs)	on supply terminals differential mode	EN 61000-4-5	1.5 kV	
Terminals		solid cable	stranded cable	
Max. wire size	mm ²	1 x 1.5	1 x 1.5	
	AWG	1 x 14	1 x 16	
Wire strip length	mm	9		
Other data		7S.12	7S.14	7S.16
Bounce time: NO/NC	ms	2/8	1/20	1/20
Vibration resistance (10...200)Hz: NO/NC	g	10/5	15/4	15/4
Shock resistance: NO/NC	g	20/6	25/13	25/13
Power lost to the environment	without contact current	W	0.8	0.8
	with rated current	W	1.4	2.3

Type of insulation between coil and contacts and between adjacent contacts

Code		
Type of Insulation		Overvoltage category
R	Reinforced	III
B	Basic	III
R2	Reinforced	II

7S.12....5110			
	Coil	13-14	21-22
Coil	—	R	R
13-14		—	B/R2
21-22			—

7S.14....0310					
	Coil	13-14	21-22	33-34	43-44
Coil	—	B	R	R	R
13-14		—	B	R	R
21-22			—	R	R
33-34				—	B/R2
43-44					—

7S.16....0420							
	Coil	13-14	21-22	31-32	43-44	53-54	63-64
Coil	—	B	R	R	R	R	R
13-14		—	B	R	R	R	R
21-22			—	R	R	R	R
31-32				—	B/R2	R	R
43-44					—	B/R2	R
53-54						—	B/R2
63-64							—

7S.14....0220					
	Coil	11-12	21-22	33-34	43-44
Coil	—	R	R	R	R
11-12		—	R	R	R
21-22			—	R	R
33-34				—	B/R2
43-44					—

Contact specifications

Contact diagrams

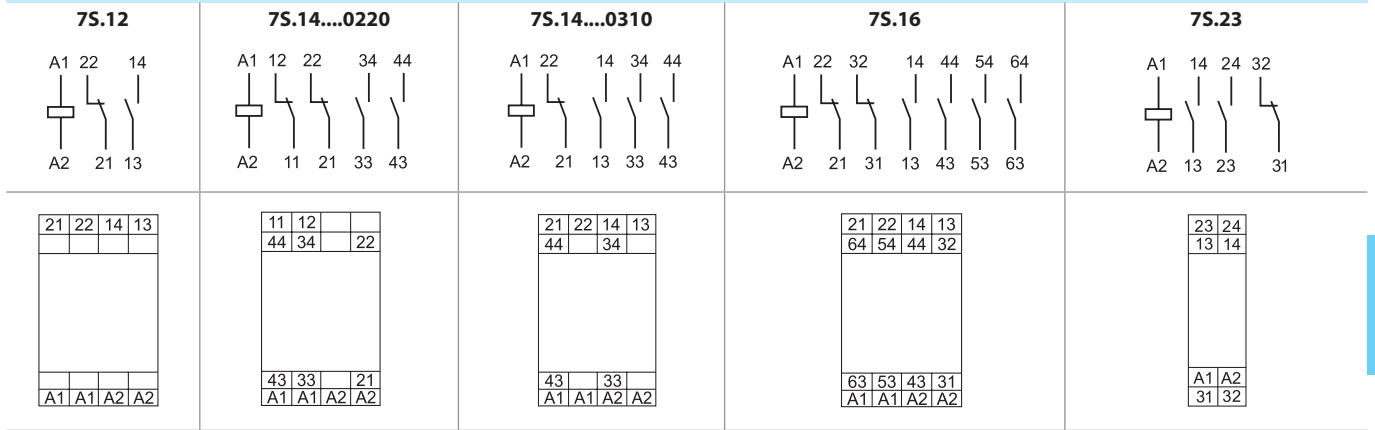

F 7S12 - Electrical life (AC) v contact current - 7S.12

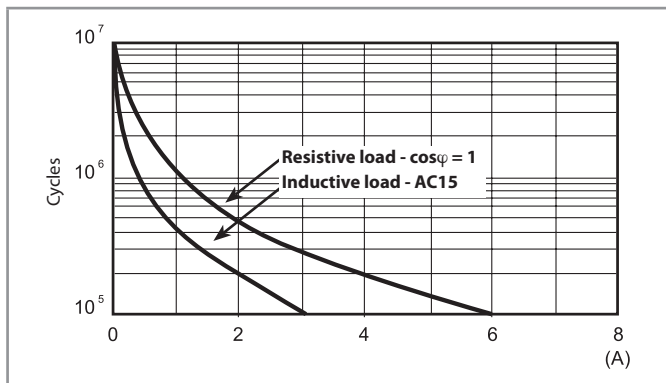

H 7S12 - Maximum DC breaking capacity - 7S.12

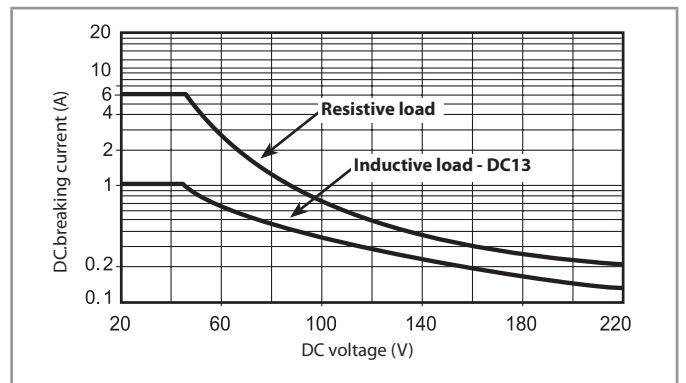

• When switching a load having voltage and current values under the curve, an electrical life of $\geq 100 \cdot 10^3$ can be expected.

F 7S16 - Electrical life (AC) v contact current - 7S.14 / 7S.16

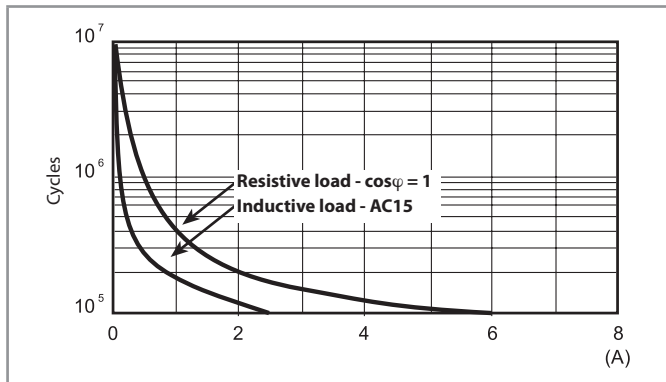

H 7S16 - Maximum DC breaking capacity - 7S.14 / 7S.16

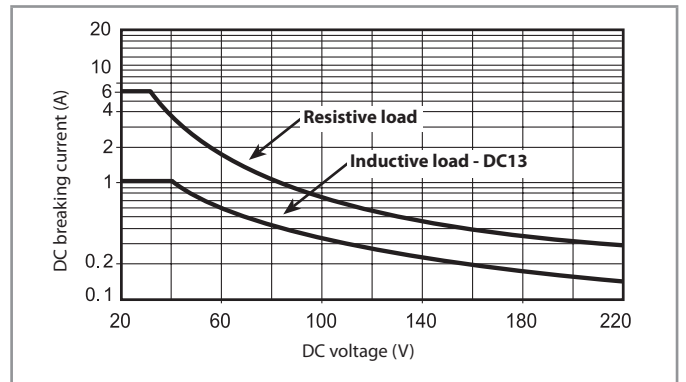

• When switching a load having voltage and current values under the curve, an electrical life of $\geq 100 \cdot 10^3$ can be expected.

F 7S23 - Electrical life (AC) v contact current - 7S.23

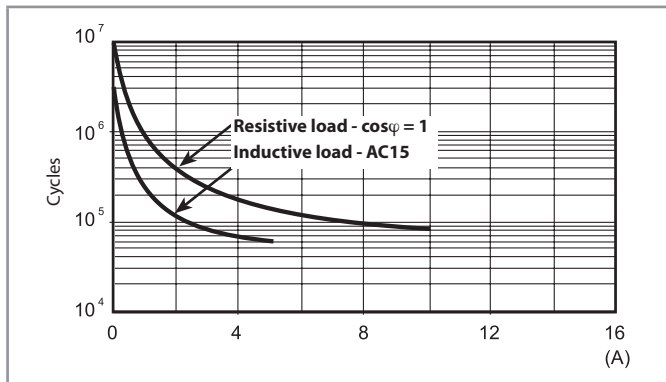

H 7S23 - Maximum DC breaking capacity - 7S.23

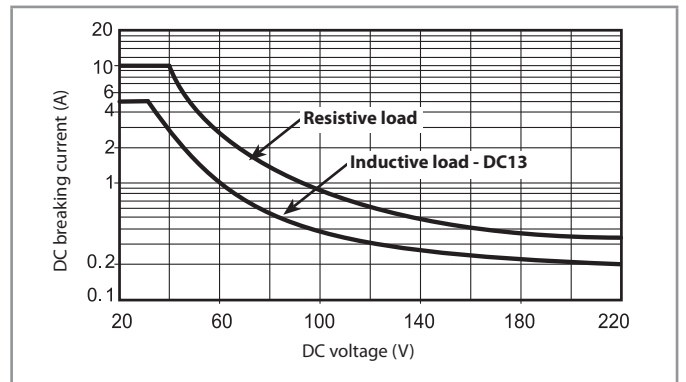

• When switching a load having voltage and current values under the curve, an electrical life of $\geq 100 \cdot 10^3$ can be expected.



Coil specifications

DC coil data - type 7S.12

Nominal voltage	Coil code	Operating range		Rated input current at U_N	Rated power at U_N
		U_{min}	U_{max}		
U_N		V	V	I_N	W
V		V	V	mA	W
12	9.012	9.6	14.4	55	0.7
24	9.024	16.8	30	38.2	0.9

AC coil data - type 7S.12

Nominal voltage	Coil code	Operating range		Rated input current at U_N	Rated power at U_N
		U_{min}	U_{max}		
U_N		V	V	I_N	VA/W
V		V	V	mA	VA/W
110...125	8.120	93	138	9.5	1.1/1
230...240	8.230	195	264	9	2/0.8

DC coil data - type 7S.14 / 7S.16

Nominal voltage	Coil code	Operating range		Rated input current at U_N	Rated power at U_N
		U_{min}	U_{max}		
U_N		V	V	I_N	W
V		V	V	mA	W
12	9.012	9.6	14.4	56	0.7
24	9.024	16.8	30	28	0.7
110	9.110	77	138	9.2	0.7

AC coil data - type 7S.14 / 7S.16

Nominal voltage	Coil code	Operating range		Rated input current at U_N	Rated power at U_N
		U_{min}	U_{max}		
U_N		V	V	I_N	VA/W
V		V	V	mA	VA/W
110...125	8.120	93	138	8.9	1.1/0.9
230...240	8.230	195	264	8.5	2/0.8

DC coil data - type 7S.23

Nominal voltage	Coil code	Operating range		Rated input current at U_N	Rated power at U_N
		U_{min}	U_{max}		
U_N		V	V	I_N	W
V		V	V	mA	W
12	9.012	9.6	14.4	50	0.6
24	9.024	16.8	30	25	0.6
48	9.048	33.6	60	12.5	0.6
110	9.110	77	138	5.4	0.6

R 7S - DC coil operating range v ambient temperature - 7S.12 / 7S.23 / 7S.14 / 7S.16

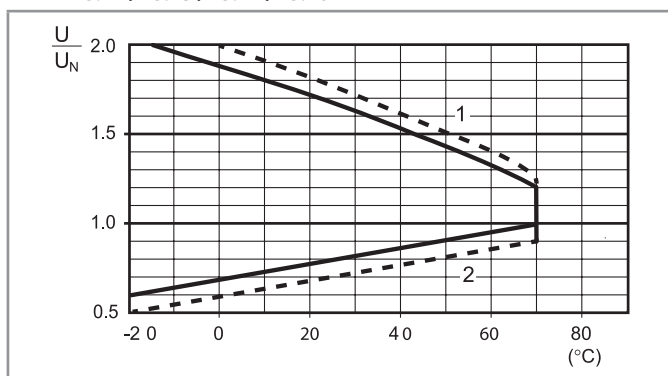

- 1 - Max. permitted coil voltage.
 2 - Min. pick-up voltage with coil at ambient temperature.
 ----- 24 and 110V DC coils only (extended range)

R 7S - AC coil operating range v ambient temperature - 7S.12 / 7S.14 / 7S.16

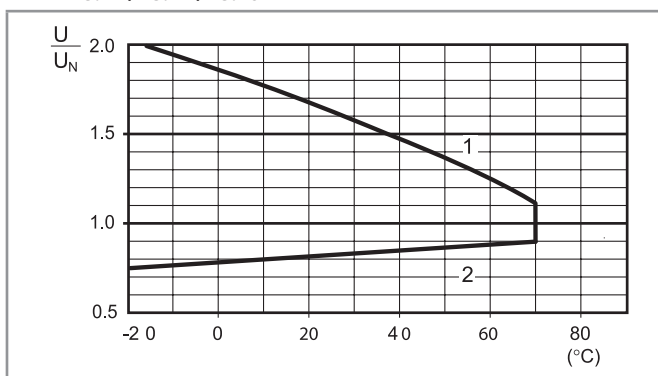

- 1 - Max. permitted coil voltage.
 2 - Min. pick-up voltage with coil at ambient temperature.

Outline drawings

75
Screwless terminal

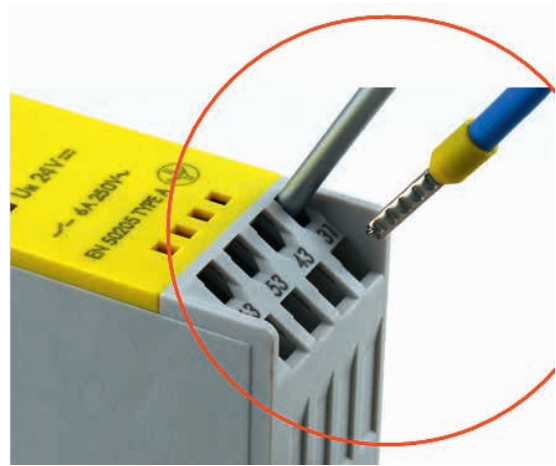
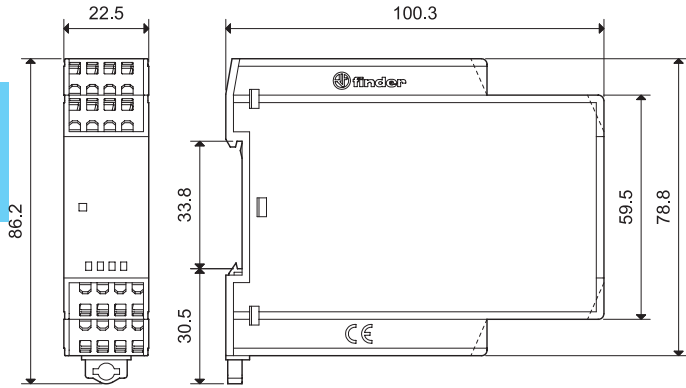

75.23
Screw terminal

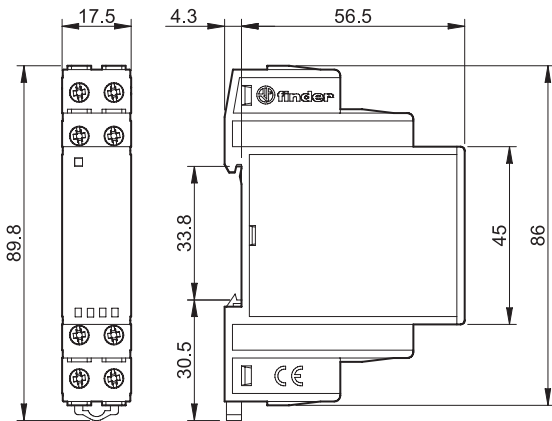

Accessories

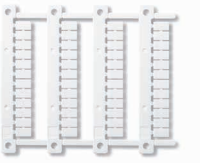

060.48

Sheet of marker tags, plastic, 48 tags, 6 x 12 mm, for CEMBRE thermal transfer printers

060.48

X-ON Electronics

Largest Supplier of Electrical and Electronic Components

Click to view similar products for [Safety Relays](#) category:

Click to view products by [Finder](#) manufacturer:

Other Similar products are found below :

[7-1618103-5](#) [1351-1X](#) [1618082-4](#) [1618111-1](#) [C200HDA003](#) [C200HMR432](#) [C200HMR832](#) [C200HMR833](#) [C28PEDRA](#) [20-050-36X](#)
[C500ETL01](#) [C500OD415CN](#) [2-1618068-0](#) [9-1618103-2](#) [SP10-ETL01](#) [C200HNC112](#) [C200HOD214](#) [C500CN812N](#) [4NK0AQY](#) [1100-42X](#)
[V23050A1012A551](#) [7-1618103-6](#) [WTD-101X](#) [SP16DRD](#) [SP16DRA](#) [C500-CE243](#) [C500-IDS02-V1](#) [3SK1111-1AW20](#) [607.5111.020](#)
[DOLD 48173](#) [750136](#) [784131](#) [PSR-MS21-1NO-1DO-24DC-SC](#) [600PSR-165/300-CU](#) [J73KN-AM-22](#) [SR6V6K18](#) [SR4M4005](#)
[2TLA010033R3000](#) [2TLA010033R2000](#) [2TLA010033R0000](#) [2TLA010017R0100](#) [2TLA010026R0400](#) [7S.32.9.024.5110](#) [7S.34.9.110.4220](#)
[7S.36.9.024.5420](#) [3100.0110I](#) [XPSUDN33AP](#) [HA1E-AC12V](#) [V23050A1012A533](#) [774303](#)