

Features

- 20 mm² PIN detector
- Low dark current
- High shunt resistance
- High sensitivity

Description

Circular active area PIN photodiode with 20 mm² active area. Metal can type hermetic TO8 package with clear glass window.

Application

- Precision photometry
- Bar code readers
- Medical equipment
- Pulsed light sensor

RoHS

2011/65/EU



Absolute maximum ratings

Symbol	Parameter	Min	Max	Unit
T _{STG}	Storage temp	-55	125	°C
T _{OP}	Operating temp	-40	100	°C
V _{max}	Max reverse voltage		30	V
I _{PEAK}	Peak DC current		10	mA

Spectral response (23 °C)

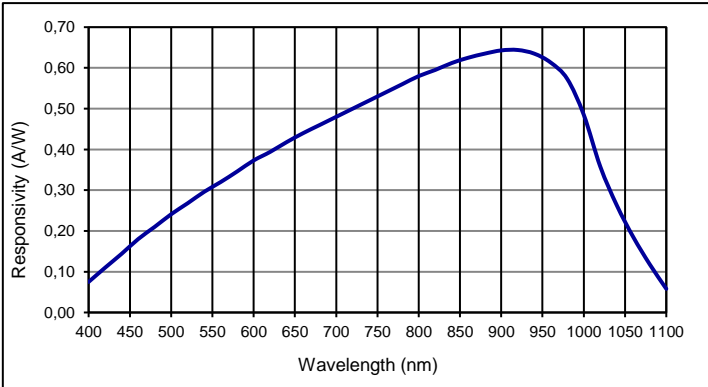

Schematic

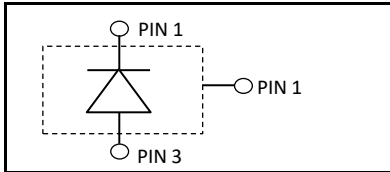

Electro-optical characteristics @ 23 °C

Symbol	Characteristic	Test Condition	Min	Typ	Max	Unit
	Active area		diameter 5050			μm
	Active area		20			mm ²
I _D	Dark current	V _R = 10 V		0.3	3	nA
C	Capacitance	V _R = 0 V		220		pF
		V _R = 10 V		35		pF
	Responsivity	λ = 632 nm		0.4		A/W
		λ = 900 nm		0.64		A/W
t _R	Rise time	V _R = 0 V; λ = 850 nm; R _L = 50 Ω		2000		ns
		V _R = 10 V; λ = 850 nm; R _L = 50 Ω		25		ns
		V _R = 20 V; λ = 850 nm; R _L = 50 Ω		15		ns
		V _R = 80 V; λ = 850 nm; R _L = 50 Ω		6		ns
	Shunt Resistance	V _R = 10 mV		700		MΩ
	N.E.P.	V _R = 10 V; λ = 900 nm		1.5 E-14		W/√Hz
V _{BR}	Breakdown voltage	I _R = 2 μA	30			V

European, International Sales:

First Sensor AG
 Peter-Behrens-Strasse 15
 12459 Berlin
 Germany
 T +49 30 6399 2399
 F +49 30 639923-752
 sales.opto@first-sensor.com

USA:

First Sensor Inc.
 5700 Corsa Avenue #105
 Westlake Village
 CA 91362 USA
 T +1 818 706 3400
 F +1 818 889 7053
 sales.us@first-sensor.com

Quantum efficiency (23 °C)

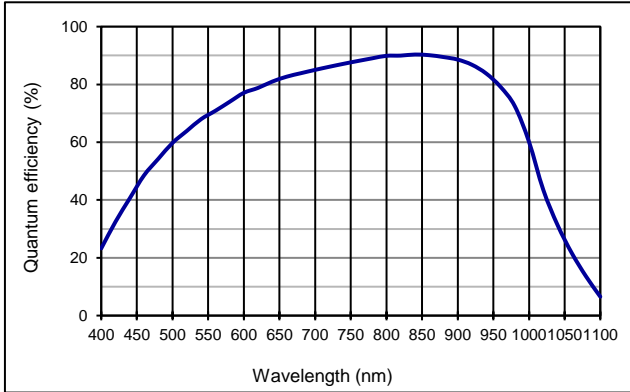

Capacitance as fct of reverse bias (23 °C)

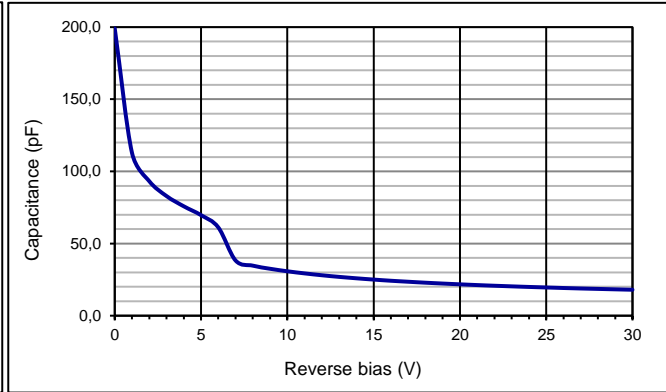

Dark current as fct of bias (23 °C)

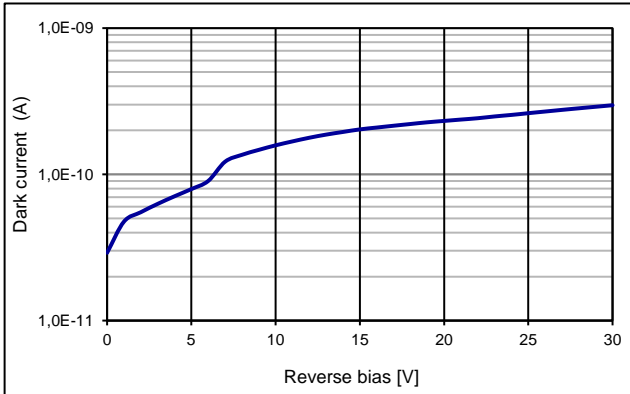

Dark current as fct of temperature (10 V)

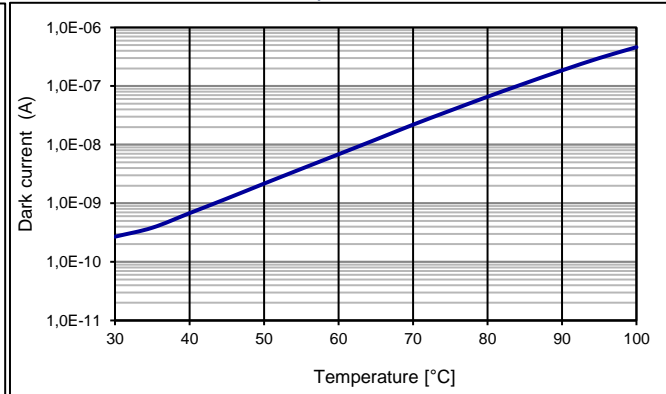

Package dimension:

Small quantities: Foam pad, boxed (12 cm x 16.5 cm)

Handling:

Please refer to document "Instructions for handling and processing"

Disclaimer: Due to our strive for continuous improvement, specifications are subject to change within our PCN policy according to JESD46C.

European, International Sales:

First Sensor AG
 Peter-Behrens-Strasse 15
 12459 Berlin
 Germany
 T +49 30 6399 2399
 F +49 30 639923-752
 sales.opto@first-sensor.com

USA:

First Sensor Inc.
 5700 Corsa Avenue #105
 Westlake Village
 CA 91362 USA
 T +1 818 706 3400
 F +1 818 889 7053
 sales.us@first-sensor.com

Dimensions

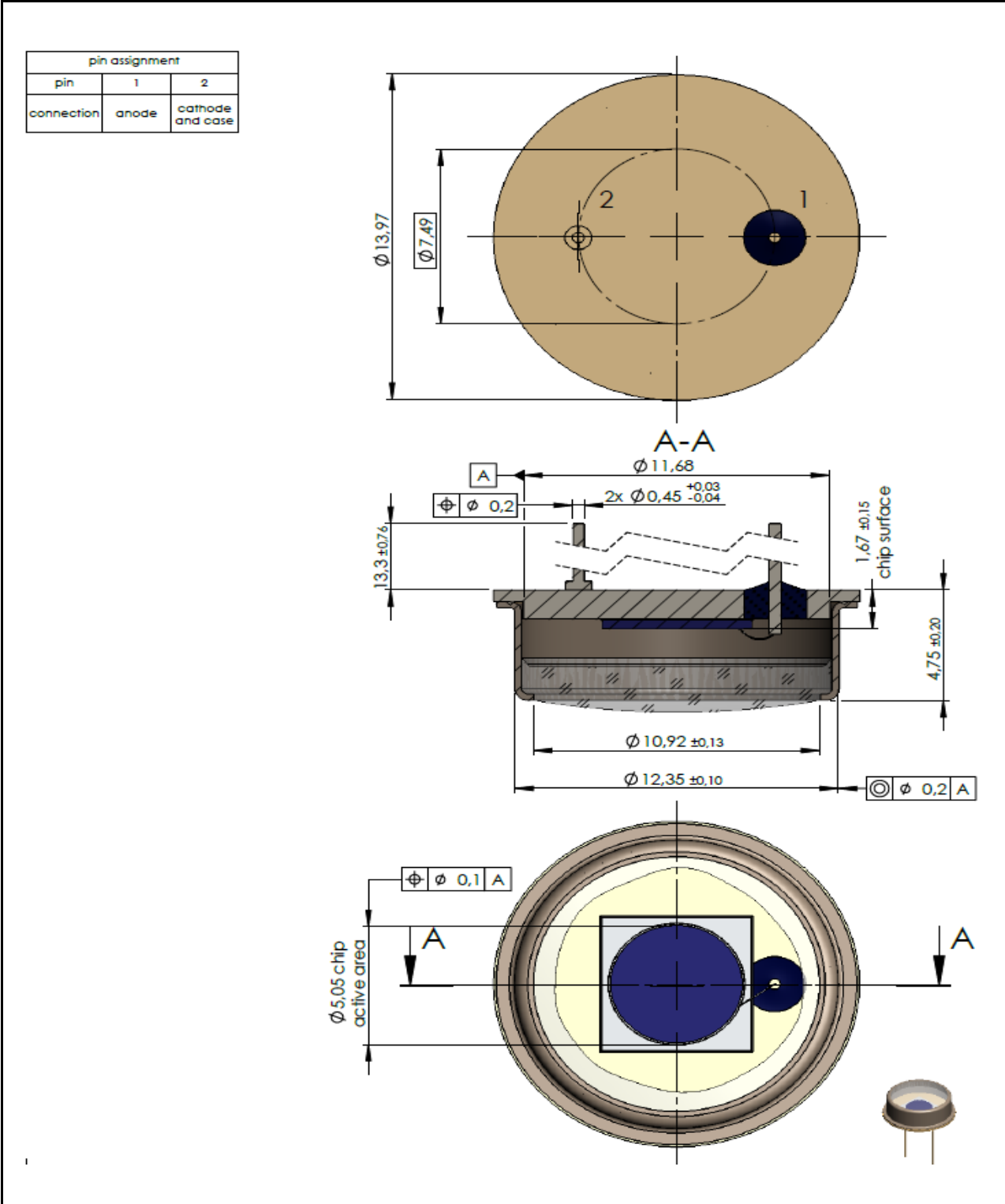

European, International Sales:

First Sensor AG
 Peter-Behrens-Strasse 15
 12459 Berlin
 Germany
 T +49 30 6399 2399
 F +49 30 639923-752
 sales.opto@first-sensor.com

USA:

First Sensor Inc.
 5700 Corsa Avenue #105
 Westlake Village
 CA 91362 USA
 T +1 818 706 3400
 F +1 818 889 7053
 sales.us@first-sensor.com

X-ON Electronics

Largest Supplier of Electrical and Electronic Components

Click to view similar products for [Photodiodes](#) category:

Click to view products by [First Sensor](#) manufacturer:

Other Similar products are found below :

[LTR-526AD](#) [OED-SP-7L](#) [LTR-536AB](#) [LTR-743DBM1-TA](#) [67-21SYGC-S349-TR8](#) [SFH 2200 A01](#) [HFD3081-108-XBA](#) [BPW 34 S E9601](#)
[SFH 2713](#) [SFH 2703](#) [LTR-546AD](#) [BPV23FL](#) [BPW 34 FAS](#) [BPW 34 FS](#) [IG22X250S4I](#) [VTD205H](#) [VTD205KH](#) [VTP1220FBH](#) [VTP1232FH](#)
[VTP4085H](#) [SFH 2400](#) [OP913WSL](#) [OPF794](#) [PD70-01C/TR7](#) [LTR-536AD](#) [VTP8651H](#) [VTD206KH](#) [VTB1013H](#) [BPV23NF](#) [OP905](#) [LTR-](#)
[516AD](#) [BPW 34 FS-Z](#) [VTD34FH](#) [QSB34CGR](#) [SFH 2500 FA](#) [SFH 213 FA](#) [PD15-22C/TR8](#) [VEMD5510C](#) [SFH 2200](#) [VEMD5510CF](#)
[APS5130PD7C-P22](#) [SAH230M](#) [SAH230M2](#) [SAH500M2](#) [BP 104 FS](#) [BPV22F-AS12](#) [BPW 21](#) [BPW 34 SR-Z](#) [BPX 65](#) [HSDL-5400#011](#)