









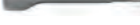

14

Drills and bits

Hammer drill bit Quattric II	606	
Hammer drill bit SDS Plus II Pointer	610	
Masonry drill bit Pointer M	614	
Hammer drill bit SDS Max II / SDS Max IV	615	
Hollow drill bit FHD	618	
Stone drill bit D-S	620	
Premium chisel FCP	621	
Standard chisel	622	
ProfiBit FPB	623	
DiamondBit FDB	624	
MaxxBit FMB	625	
BitHolder FBH	626	
BitSet	627	
Accessories for impact driver	628	

Hammer drill bit Quattric II

The expert for the best performance in reinforced concrete



Applications

To create approval-compliant drill holes in:

- Reinforced concrete
- Concrete
- Solid brick
- Sand-lime brick

Also suitable for:

- Natural stone

Advantages

- Carbide head (up to \varnothing 10 mm) for long service life.
- Power shoulders for improved breakup performance in concrete.
- Massive main cutting edges for quick drilling progress.
- Reinforcement chamfers prevent jamming in the reinforcement.
- Centring tip for simple positioning.
- Wear mark for simple recognition of wear limit in accordance with PGM.
- Two-piece spiral for quick drilling progress and increased service life.

14

Characteristics



Technical data

Hammer drill bit Quattric II

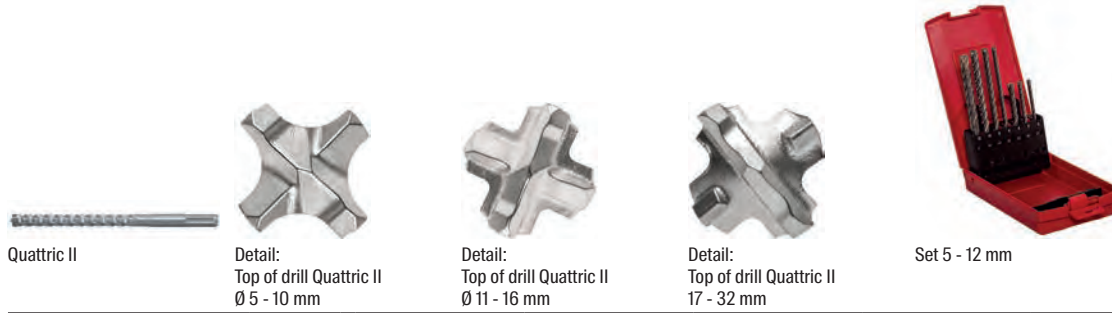

Item	Item No.	Drill hole diameter d_0 [mm]	Working length [mm]	Total length l [mm]	Type of packaging	Contents	Sales unit [pcs]
Quattric II 5/50/115	549973	5	50	115	Plastic clip	1	1
Quattric II 5/100/165	549974	5	100	165	Plastic clip	1	1
Quattric II 5/150/215	544214	5	150	215	Plastic clip	1	1
Quattric II 5,5/50/115	549971	5,5	50	115	Plastic clip	1	1
Quattric II 5,5/100/165	549972	5,5	100	165	Plastic clip	1	1
Quattric II 6/50/115	549983	6	50	115	Plastic clip	1	1
Quattric II 6/100/165	549979	6	100	165	Plastic clip	1	1
Quattric II 6/150/215	549981	6	150	215	Plastic clip	1	1
Quattric II 6/200/265	549985	6	200	265	Plastic clip	1	1
Quattric II 6/250/315	549986	6	250	315	Plastic clip	1	1
Quattric II 6,5/100/165	549975	6,5	100	165	Plastic clip	1	1
Quattric II 6,5/150/215	549976	6,5	150	215	Plastic clip	1	1
Quattric II 6,5/200/265	549977	6,5	200	265	Plastic clip	1	1
Quattric II 6,5/250/315	549978	6,5	250	315	Plastic clip	1	1
Quattric II 8/50/115	549993	8	50	115	Plastic clip	1	1
Quattric II 8/100/165	549988	8	100	165	Plastic clip	1	1
Quattric II 8/150/215	549990	8	150	215	Plastic clip	1	1
Quattric II 8/200/265	549994	8	200	265	Plastic clip	1	1
Quattric II 8/250/315	549992	8	250	315	Plastic clip	1	1
Quattric II 8/300/365	549995	8	300	365	Plastic clip	1	1
Quattric II 8/400/465	549996	8	400	465	Plastic clip	1	1
Quattric II 10/50/115	549928	10	50	115	Plastic clip	1	1
Quattric II 10/100/165	549922	10	100	165	Plastic clip	1	1
Quattric II 10/150/215	549925	10	150	215	Plastic clip	1	1
Quattric II 10/200/265	549929	10	200	265	Plastic clip	1	1
Quattric II 10/250/315	549927	10	250	315	Plastic clip	1	1
Quattric II 10/300/365	544224	10	300	365	Plastic clip	1	1
Quattric II 10/390/455	549930	10	390	455	Plastic clip	1	1
Quattric II 10/540/600	544222	10	540	600	Plastic clip	1	1
Quattric II 12/110/160	549932	12	110	160	Plastic clip	1	1
Quattric II 12/160/210	549936	12	160	210	Plastic clip	1	1
Quattric II 12/210/260	549934	12	210	260	Plastic clip	1	1
Quattric II 12/260/310	549939	12	260	310	Plastic clip	1	1
Quattric II 12/400/450	549935	12	400	450	Plastic clip	1	1
Quattric II 12/550/600	544213	12	550	600	Plastic clip	1	1
Quattric II 12/950/1000	549931	12	950	1000	Plastic clip	1	1
Quattric II 14/110/160	549941	14	110	160	Plastic clip	1	1
Quattric II 14/160/210	549944	14	160	210	Plastic clip	1	1
Quattric II 14/210/260	549942	14	210	260	Plastic clip	1	1
Quattric II 14/260/310	549945	14	260	310	Plastic clip	1	1
Quattric II 14/400/450	549943	14	400	450	Plastic clip	1	1
Quattric II 14/550/600	544223	14	550	600	Plastic clip	1	1
Quattric II 14/950/1000	549940	14	950	1000	Plastic clip	1	1
Quattric II 15/110/160	549946	15	110	160	Plastic clip	1	1
Quattric II 15/160/210	549947	15	160	210	Plastic clip	1	1
Quattric II 15/210/260	544215	15	210	260	Plastic clip	1	1

Technical data

Hammer drill bit Quattric II



Item	Item No.	Drill hole diameter d_0 [mm]	Working length [mm]	Total length l [mm]	Type of packaging	Contents	Sales unit [pcs]
Quattric II 16/110/160	549950	16	110	160	Plastic clip	1	1
Quattric II 16/160/210	549951	16	160	210	Plastic clip	1	1
Quattric II 16/210/260	549952	16	210	260	Plastic clip	1	1
Quattric II 16/260/310	549953	16	260	310	Plastic clip	1	1
Quattric II 16/400/450	549954	16	400	450	Plastic clip	1	1
Quattric II 16/550/600	549955	16	550	600	Plastic clip	1	1
Quattric II 16/950/1000	549948	16	950	1000	Plastic clip	1	1
Quattric II 18/200/250	549956	18	200	250	Plastic tube	1	1
Quattric II 18/400/450	549957	18	400	450	Plastic tube	1	1
Quattric II 20/200/250	549958	20	200	250	Plastic tube	1	1
Quattric II 20/400/450	549959	20	400	450	Plastic tube	1	1
Quattric II 22/200/250	549960	22	200	250	Plastic tube	1	1
Quattric II 22/400/450	549961	22	400	450	Plastic tube	1	1
Quattric II 24/200/250	549962	24	200	250	Plastic tube	1	1
Quattric II 24/400/450	549963	24	400	450	Plastic tube	1	1
Quattric II 25/200/250	549964	25	200	250	Plastic tube	1	1
Quattric II 25/400/450	549965	25	400	450	Plastic tube	1	1
Quattric II 28/200/250	549966	28	200	250	Plastic tube	1	1
Quattric II 28/400/450	549967	28	400	450	Plastic tube	1	1
Quattric II 30/200/250	549968	30	200	250	Plastic tube	1	1
Quattric II 30/400/450	549969	30	400	450	Plastic tube	1	1
Quattric II 32/400/450	549970	32	400	450	Plastic tube	1	1
Quattric II 6/50/115 XP5	549984	6	50	115	Plastic tube	5	1
Quattric II 6/100/165 XP5	544225	6	100	165	Plastic tube	5	1
Quattric II 6/150/215 XP5	549982	6	150	215	Plastic tube	5	1
Quattric II 6/200/265 XP5	552131	6	200	265	Plastic tube	5	1
Quattric II 6,5/100/165 XP5	544217	6,5	100	165	Plastic tube	5	1
Quattric II 6,5/150/215 XP5	544218	6,5	150	215	Plastic tube	5	1
Quattric II 6,5/200/265 XP5	544219	6,5	200	265	Plastic tube	5	1
Quattric II 8/100/165 XP5	549989	8	100	165	Plastic tube	5	1
Quattric II 8/150/215 XP5	549991	8	150	215	Plastic tube	5	1
Quattric II 8/200/265 XP5	552132	8	200	265	Plastic tube	5	1
Quattric II 10/100/165 XP5	549924	10	100	165	Plastic tube	5	1
Quattric II 10/150/215 XP5	549926	10	150	215	Plastic tube	5	1
Quattric II 10/200/265 XP5	552133	10	200	265	Plastic tube	5	1
Quattric II 12/110/160 XP5	549933	12	110	160	Plastic tube	5	1
Quattric II 12/160/210 XP5	549937	12	160	210	Plastic tube	5	1
Quattric II 12/210/260 XP5	549938	12	210	260	Plastic tube	5	1
Quattric II 12/260/310 XP5	552134	12	260	310	Plastic tube	5	1
Quattric II 14/110/160 XP5	544220	14	110	160	Plastic tube	5	1
Quattric II 14/160/210 XP5	544221	14	160	210	Plastic tube	5	1
Quattric II 6/100/165 XP10	549980	6	100	165	Plastic tube	10	1
Quattric II 6/150/215 XP10	544185	6	150	215	Plastic tube	10	1
Quattric II 8/100/165 XP10	544216	8	100	165	Plastic tube	10	1
Quattric II 8/150/215 XP10	544186	8	150	215	Plastic tube	10	1
Quattric II 10/100/165 XP10	549923	10	100	165	Plastic tube	10	1

Technical data

Hammer drill bit Quattric II



Item	Item No.	Drill hole diameter d_0 [mm]	Working length [mm]	Total length l [mm]	Type of packaging	Contents	Sales unit [pcs]
Quattric II 10/150/215 XP10	544187	10	150	215	Plastic tube	10	1
Quattric II 12/110/160 XP10	552129	12	110	160	Plastic tube	10	1
Quattric II 12/160/210 XP10	544188	12	160	210	Plastic tube	10	1
Quattric II 12/210/260 XP10	552130	12	210	260	Plastic tube	10	1
Quattric II Set 5 - 12 mm	553210	5	50	115	Cassette	7	1
		6	50	115			
		6	100	165			
		8	50	115			
		8	100	165			
		12	100	165			

Hammer drill bit SDS Plus II Pointer

The two-flute cutter is setting new standards when it comes to drilling speed



Applications

To create approval-compliant drill holes in:

- Concrete
- Solid brick
- Sand-lime brick

Also suitable for:

- Natural stone

Advantages

- The optimised drill bit geometry enables fast drilling progress, reduced wear and less effort.
- The centring tip allows easy and precise drilling and prevents slipping on smooth surfaces.
- The “Power Breakers” on the drill bit head have a “destructive effect”. They create micro-cracks in the material and achieve a noticeably improved drilling speed.
- The larger reinforcement chamfers (+35%) guarantee that the drill acts in the best possible way when it hits concrete

reinforcements. This considerably reduces the risk of problems caused by drill jamming.

- The new Vario KVS spiral offers further advantages: The narrow crown width behind the drill bit head reduces friction and ensures stronger energy transfer during percussion drilling. The improved helix enables ideal transport of the drill residues. The spiral shape increases the stability and thus also the break resistance.

14

Characteristics



Technical data

Hammer drill bit SDS Plus II Pointer



SDS Plus II Pointer



Detail: top of drill SDS Plus II Pointer

Item	Item No.	Drill hole diameter d_0 [mm]	Working length [mm]	Total length l [mm]	Type of packaging	Contents [pcs]	Sales unit [pcs]
SDS Plus-V II 4/50/110	531753	4	50	110	Plastic clip	1	1
SDS Plus-V II 4/100/160	531754	4	100	160	Plastic clip	1	1
SDS Plus-V II 5/50/110	531755	5	50	110	Plastic clip	1	1
SDS Plus-V II 5/100/160	531756	5	100	160	Plastic clip	1	1
SDS Plus-V II 5/150/210	531757	5	150	210	Plastic clip	1	1
SDS Plus-V II 5/250/310	531759	5	250	310	Plastic clip	1	1
SDS Plus-V II 5,5/100/160	531761	5,5	100	160	Plastic clip	1	1
SDS Plus-V II 5,5/150/210	531762	5,5	150	210	Plastic clip	1	1
SDS Plus II 5,5/250/310	531763	5,5	250	310	Plastic clip	1	1
SDS Plus-V II 6/50/110	531765	6	50	110	Plastic clip	1	1
SDS Plus-V II 6/100/160	531766	6	100	160	Plastic clip	1	1
SDS Plus-V II 6/150/210	531767	6	150	210	Plastic clip	1	1
SDS Plus-V II 6/200/260	531768	6	200	260	Plastic clip	1	1
SDS Plus-V II 6/250/310	531769	6	250	310	Plastic clip	1	1
SDS Plus-V II 6,5/50/110	531770	6,5	50	110	Plastic clip	1	1
SDS Plus-V II 6,5/100/160	531771	6,5	100	160	Plastic clip	1	1
SDS Plus-V II 6,5/150/210	531772	6,5	150	210	Plastic clip	1	1
SDS Plus-V II 6,5/200/260	531773	6,5	200	260	Plastic clip	1	1
SDS Plus-V II 6,5/250/310	531774	6,5	250	310	Plastic clip	1	1
SDS Plus-V II 7/50/110	531775	7	50	110	Plastic clip	1	1
SDS Plus-V II 7/100/160	531776	7	100	160	Plastic clip	1	1
SDS Plus-V II 7/150/210	531777	7	150	210	Plastic clip	1	1
SDS Plus-V II 7/190/250	531778	7	190	250	Plastic clip	1	1
SDS Plus-V II 8/50/110	531779	8	50	110	Plastic clip	1	1
SDS Plus-V II 8/100/160	531780	8	100	160	Plastic clip	1	1
SDS Plus-V II 8/150/210	531781	8	150	210	Plastic clip	1	1
SDS Plus-V II 8/200/260	531782	8	200	260	Plastic clip	1	1
SDS Plus-V II 8/250/310	531783	8	250	310	Plastic clip	1	1
SDS Plus-V II 8/340/400	531784	8	340	400	Plastic clip	1	1
SDS Plus-V II 8/400/460	531785	8	400	460	Plastic clip	1	1
SDS Plus-V II 8/540/600	531786	8	540	600	Plastic clip	1	1
SDS Plus-V II 9/100/160	531788	9	100	160	Plastic clip	1	1
SDS Plus-V II 9/150/210	531789	9	150	210	Plastic clip	1	1
SDS Plus-V II 9,5/100/160	531790	9,5	100	160	Plastic clip	1	1
SDS Plus-V II 10/50/110	531791	10	50	110	Plastic clip	1	1
SDS Plus-V II 10/100/160	531792	10	100	160	Plastic clip	1	1
SDS Plus-V II 10/150/210	531793	10	150	210	Plastic clip	1	1
SDS Plus-V II 10/200/260	531794	10	200	260	Plastic clip	1	1
SDS Plus-V II 10/250/310	531795	10	250	310	Plastic clip	1	1
SDS Plus-V II 10/290/350	531796	10	290	350	Plastic clip	1	1
SDS Plus-V II 10/390/450	531797	10	390	450	Plastic clip	1	1
SDS Plus-V II 10/550/600	531798	10	540	600	Plastic clip	1	1
SDS Plus-V II 10/740/800	531799	10	740	800	Plastic clip	1	1
SDS Plus-V II 10/950/1000	531800	10	940	1000	Plastic clip	1	1
SDS Plus-V II 11/110/160	531801	11	100	160	Plastic clip	1	1
SDS Plus-V II 11/260/310	531802	11	260	310	Plastic clip	1	1
SDS Plus-V II 12/110/160	531803	12	110	160	Plastic clip	1	1
SDS Plus-V II 12/160/210	531804	12	160	210	Plastic clip	1	1
SDS Plus-V II 12/210/260	531805	12	210	260	Plastic clip	1	1
SDS Plus-V II 12/260/310	531806	12	260	310	Plastic clip	1	1

Technical data

Hammer drill bit SDS Plus II Pointer



SDS Plus II Pointer

Detail: top of drill SDS Plus II Pointer

Item	Item No.	Drill hole diameter d ₀ [mm]	Working length [mm]	Total length l [mm]	Type of packaging	Contents [pcs]	Sales unit [pcs]
SDS Plus-V II 12/310/360	531807	12	310	360	Plastic clip	1	1
SDS Plus-V II 12/400/450	531808	12	400	450	Plastic clip	1	1
SDS Plus-V II 12/550/600	531809	12	550	600	Plastic clip	1	1
SDS Plus-V II 12/950/1000	531810	12	950	1000	Plastic clip	1	1
SDS Plus-V II 13/110/160	531811	13	100	160	Plastic clip	1	1
SDS Plus-V II 13/160/210	531812	13	160	210	Plastic clip	1	1
SDS Plus-V II 13/210/260	531813	13	210	260	Plastic clip	1	1
SDS Plus-V II 13/260/310	531814	13	260	310	Plastic clip	1	1
SDS Plus-V II 14/110/160	531815	14	110	160	Plastic clip	1	1
SDS Plus-V II 14/160/210	531816	14	160	210	Plastic clip	1	1
SDS Plus-V II 14/210/260	531817	14	210	260	Plastic clip	1	1
SDS Plus-V II 14/260/310	531818	14	260	310	Plastic clip	1	1
SDS Plus-V II 14/400/450	531819	14	400	450	Plastic clip	1	1
SDS Plus-V II 14/550/600	531820	14	550	600	Plastic clip	1	1
SDS Plus-V II 14/950/1000	531821	14	950	1000	Plastic clip	1	1
SDS Plus-V II 15/110/160	531822	15	110	160	Plastic clip	1	1
SDS Plus-V II 15/160/210	531823	15	160	210	Plastic clip	1	1
SDS Plus-V II 15/210/260	531824	15	210	260	Plastic clip	1	1
SDS Plus-V II 15/400/450	531825	15	400	450	Plastic clip	1	1
SDS Plus-V II 16/110/160	531826	16	110	160	Plastic clip	1	1
SDS Plus-V II 16/160/210	531827	16	160	210	Plastic clip	1	1
SDS Plus-V II 16/210/260	531828	16	210	260	Plastic clip	1	1
SDS Plus-V II 16/260/310	531829	16	260	310	Plastic clip	1	1
SDS Plus-V II 16/400/450	531830	16	400	450	Plastic clip	1	1
SDS Plus-V II 16/550/600	531831	16	550	600	Plastic clip	1	1
SDS Plus-V II 16/750/800	531832	16	750	800	Plastic clip	1	1
SDS Plus-V II 16/950/1000	531833	16	950	1000	Plastic clip	1	1
SDS Plus-V II 17/160/210	531834	17	160	210	Plastic clip	1	1
SDS Plus-V II 17/400/450	531835	17	400	450	Plastic clip	1	1
SDS Plus-V II 18/150/200	531836	18	150	200	Plastic clip	1	1
SDS Plus-V II 18/250/300	531837	18	250	300	Plastic clip	1	1
SDS Plus-V II 18/400/450	531838	18	400	450	Plastic clip	1	1
SDS Plus-V II 18/550/600	531839	18	550	600	Plastic clip	1	1
SDS Plus-V II 18/950/1000	531840	18	950	1000	Plastic clip	1	1
SDS Plus-V II 19/150/200	531841	19	150	200	Plastic clip	1	1
SDS Plus-V II 19/400/450	531842	19	400	450	Plastic clip	1	1
SDS Plus-V II 20/150/200	531843	20	150	200	Plastic clip	1	1
SDS Plus-V II 20/250/300	531844	20	250	300	Plastic clip	1	1
SDS Plus-V II 20/400/450	531845	20	400	450	Plastic clip	1	1
SDS Plus-V II 20/550/600	531846	20	550	600	Plastic clip	1	1
SDS Plus-V II 20/950/1000	531847	20	950	1000	Plastic clip	1	1
SDS Plus-V II 22/200/250	531849	22	200	250	Plastic clip	1	1
SDS Plus-V II 22/400/450	531850	22	400	450	Plastic clip	1	1
SDS Plus-V II 22/550/600	531851	22	550	600	Plastic clip	1	1
SDS Plus-V II 22/950/1000	531852	22	950	1000	Plastic clip	1	1
SDS Plus-V II 24/200/250	531853	24	200	250	Plastic clip	1	1
SDS Plus-V II 24/400/450	531854	24	400	450	Plastic clip	1	1
SDS Plus-V II 25/200/250	531855	25	200	250	Plastic clip	1	1
SDS Plus-V II 25/400/450	531856	25	400	450	Plastic clip	1	1
SDS Plus-V II 25/550/600	531857	25	550	600	Plastic clip	1	1

Technical data

Hammer drill bit SDS Plus II Pointer



SDS Plus II Pointer



Detail: top of drill SDS Plus II Pointer

Item	Item No.	Drill hole diameter d_0 [mm]	Working length [mm]	Total length l [mm]	Type of packaging	Contents [pcs]	Sales unit [pcs]
SDS Plus-V II 26/200/250	531858	26	200	250	Plastic clip	1	1
SDS Plus-V II 26/400/450	531859	26	400	450	Plastic clip	1	1
SDS Plus-V II 6/50/110 XP10	531860	6	50	110	Plastic tube	10	1
SDS Plus-V II 6/100/160 XP10	531861	6	100	160	Plastic tube	10	1
SDS Plus-V II 8/100/160 XP10	531862	8	100	160	Plastic tube	10	1
SDS Plus-V II 8/150/210 XP10	531863	8	150	210	Plastic tube	10	1
SDS Plus-V II 10/100/160 XP10	531864	10	100	160	Plastic tube	10	1
SDS Plus-V II 10/150/210 XP10	531865	10	150	210	Plastic tube	10	1
SDS Plus-V II 10/200/260 XP10	531866	10	200	260	Plastic tube	10	1
SDS Plus-V II 10/250/310 XP10	531867	10	250	310	Plastic tube	10	1
SDS Plus-V II 12/110/160 XP10	531868	12	110	160	Plastic tube	10	1
SDS Plus-V II 12/160/210 XP10	531869	12	160	210	Plastic tube	10	1
SDS Plus-V II 12/210/260 XP10	531870	12	210	260	Plastic tube	10	1

Masonry drill bit Pointer M

The perfect drill bit for all perforated building materials



Applications

To create drill holes in:

- Hollow bricks
- Aerated concrete
- Perforated sand-lime bricks

Ideal for:

- Frame-fixings or ETICS systems e.g. SXRL, FIS HK, fischer Thermax, EWI and VBS-M

Advantages

- Shortened SDS-Plus shank reduces the impact of the machine on the drill and prevents possible damage to the substrate (it is recommended to use the drill bit without impact).
- Precise and accurate drill holes without damage to the substrate thanks to shortened SDS-Plus shank to guarantee correct fixing with increased load capac-

ities in all types of perforated building materials.

- Diamond sharpened carbide tip with advanced cutting edges ensure fast and safe drilling progress in different materials.
- Large spiral flutes for optimal removal of dust.

14

Characteristics



Technical data

Masonry drill bit Pointer M

Pointer M

Item	Item No.	Drill hole diameter d_0 [mm]	Working length [mm]	Total length l [mm]	Type of packaging	Contents [pcs]	Sales unit [pcs]
Pointer M 6/350/410	546204	6	350	410	Pouch	1	1
Pointer M 8/200/260	544382	8	200	260	Pouch	1	1
Pointer M 8/100/400	517690	8	100	400	Pouch	1	1
Pointer M 10/200/260	543630	10	200	260	Pouch	1	1
Pointer M 12/200/260	543631	12	200	260	Pouch	1	1
Pointer M 14/200/260	543632	14	200	260	Pouch	1	1
Pointer M 16/200/260	543633	16	200	260	Pouch	1	1
Pointer M 16/100/400	543634	16	100	400	Pouch	1	1
Pointer M 18/350/410	546205	18	350	410	Plastic tube	1	1
Pointer M 20/100/400	543635	20	100	400	Plastic tube	1	1
Pointer M 22/350/410	546206	22	350	410	Plastic tube	1	1

Hammer drill bit SDS Max II / SDS Max IV

The hammer drill bits with SDS Max drill chuck



Applications

To create approval-compliant drill holes in:

- Reinforced concrete (SDS Max IV)
- Concrete
- Solid brick
- Sand-lime brick

Also suitable for:

- Natural stone

Advantages

- The SDS Max drill chuck ensures optimum transfer of force and allows for quick drilling progress for large volume drill holes.
- The drill bit head with four cutting edges prevents jamming in the concrete reinforcement.
- The quadruple flute reliably transports

the drilling dust from the drill hole, thus reducing wear.

- The core-reinforced flute ensures maximum transfer of energy, and guarantees a low-vibration drilling.
- The PGM®-compliant cutting element guarantees perfect-fit drill holes to fulfil the highest safety requirements.

Characteristics



Technical data

Hammer drill bit SDS Max II / SDS Max IV



Hammerdrill SDS Max II and IV



Detail: Top of drill SDS Max II Ø 12 - 15 mm



Detail: Top of drill SDS Max IV from Ø 16 mm

Item	Item No.	Drill hole diameter d ₀ [mm]	Working length [mm]	Total length l [mm]	Type of packaging	Contents [pcs]	Sales unit [pcs]
SDS Max II 12/200/340	504188	12	200	340	Plastic tube	1	1
SDS Max IV 12/200/340	524556	12	200	340	Plastic tube	1	1
SDS Max II 12/400/540	504189	12	400	540	Plastic tube	1	1
SDS Max IV 12/400/540	524557	12	400	540	Plastic tube	1	1
SDS Max II 14/200/340	504192	14	200	340	Plastic tube	1	1
SDS Max IV 14/200/340	524559	14	200	340	Plastic tube	1	1
SDS Max II 14/400/540	504194	14	400	540	Plastic tube	1	1
SDS Max IV 14/400/540	524560	14	400	540	Plastic tube	1	1
SDS Max II 15/200/340	504196	15	200	340	Plastic tube	1	1
SDS Max IV 15/400/540	524562	15	400	540	Plastic tube	1	1
SDS Max IV 16/200/340	504198	16	200	340	Plastic tube	1	1
SDS Max IV 16/400/540	504199	16	400	540	Plastic tube	1	1
SDS Max IV 16/800/920	504200	16	800	920	Plastic tube	1	1
SDS Max IV 16/1200/1320	504206	16	1200	1320	Plastic tube	1	1
SDS Max IV 18/200/340	504207	18	200	340	Plastic tube	1	1
SDS Max IV 18/400/540	504208	18	400	540	Plastic tube	1	1
SDS Max IV 18/800/940	504209	18	800	940	Plastic tube	1	1
SDS Max IV 18/1200/1320	504213	18	1200	1320	Flexipack	1	1
SDS Max IV 20/200/320	504214	20	200	320	Plastic tube	1	1
SDS Max IV 20/400/520	504217	20	400	520	Plastic tube	1	1
SDS Max IV 20/800/920	504222	20	800	920	Plastic tube	1	1
SDS Max IV 20/1200/1320	504223	20	1200	1320	Flexipack	1	1
SDS Max IV 22/200/320	504224	22	200	320	Plastic tube	1	1
SDS Max IV 22/400/520	504225	22	400	520	Plastic tube	1	1
SDS Max IV 22/800/920	504226	22	800	920	Plastic tube	1	1
SDS Max IV 22/1200/1320	504227	22	1200	1320	Flexipack	1	1
SDS Max IV 24/200/320	504228	24	200	320	Plastic tube	1	1
SDS Max IV 24/400/520	504229	24	400	520	Plastic tube	1	1
SDS Max IV 25/200/320	504235	25	200	320	Plastic tube	1	1
SDS Max IV 25/400/520	504236	25	400	520	Plastic tube	1	1
SDS Max IV 25/800/920	504237	25	800	920	Plastic tube	1	1
SDS Max IV 25/1200/1320	504238	25	1200	1320	Flexipack	1	1
SDS Max IV 25/2000/2120	098287	25	2000	2120	Flexipack	1	1
SDS Max IV 26/400/520	504239	26	400	520	Plastic tube	1	1
SDS Max IV 28/250/370	504240	28	250	370	Plastic tube	1	1
SDS Max IV 28/450/570	504241	28	450	570	Plastic tube	1	1
SDS Max IV 28/550/670	504242	28	550	670	Plastic tube	1	1
SDS Max IV 28/800/920	504243	28	800	920	Plastic tube	1	1
SDS Max IV 30/250/370	504245	30	250	370	Plastic tube	1	1
SDS Max IV 30/450/570	504246	30	450	570	Plastic tube	1	1
SDS Max IV 30/800/920	057779	30	800	920	Plastic tube	1	1
SDS Max IV 32/450/570	504248	32	450	570	Plastic tube	1	1
SDS Max IV 32/800/920	504249	32	800	920	Plastic tube	1	1
SDS Max IV 35/250/370	504251	35	250	370	Plastic tube	1	1
SDS Max IV 35/450/570	504256	35	450	570	Plastic tube	1	1
SDS Max IV 35/550/670	504257	35	550	670	Plastic tube	1	1
SDS Max IV 35/800/920	504258	35	800	920	Plastic tube	1	1
SDS Max IV 35/1200/1320	504259	35	1200	1320	Flexipack	1	1

1) delivery on request

Technical data

Hammer drill bit SDS Max II / SDS Max IV



Hammerdrill SDS Max II
and IV



Detail:
Top of drill SDS Max II
Ø 12 - 15 mm



Detail:
Top of drill SDS Max IV
from Ø 16 mm

Item	Item No.	Drill hole diameter d_0 [mm]	Working length [mm]	Total length l [mm]	Type of packaging	Contents [pcs]	Sales unit [pcs]
SDS Max IV 35/1620/1740	040191	35	1620	1740	Flexipack	1	1
SDS Max IV 35/2000/2140	040192 ¹⁾	35	2000	2140	Flexipack	1	1
SDS Max IV 38/450/570	504268	38	450	570	Plastic tube	1	1
SDS Max IV 40/250/370	504269	40	250	370	Plastic tube	1	1
SDS Max IV 40/450/570	504270	40	450	570	Plastic tube	1	1
SDS Max IV 40/800/920	504271	40	800	920	Plastic tube	1	1
SDS Max IV 40/1200/1320	504272	40	1200	1320	Flexipack	1	1
SDS Max IV 45/450/570	504274	45	450	570	Tube	1	1
SDS Max IV 45/800/920	504275	45	800	920	Tube	1	1
SDS Max IV 52/450/570	504276	52	450	570	Tube	1	1

1) delivery on request

Hollow drill bit FHD

Hollow drill bit for drilling with low dust as well as for efficient and approved anchoring



Applications

To create approval-compliant drill holes in:

- Reinforced concrete
- Concrete

Also suitable for:

- Solid brick
- Solid sand-lime brick
- Natural stone

Advantages

- Drilling and drill hole cleaning in one single step saves the normal cleaning of chemical and mechanical anchoring when the hollow drill bit is regulated by their respective approvals. This saves up to 55% of the complete drill hole creation process.
- The drill hole will be cleaned thoroughly guaranteeing a secure fixing (drilling dust reduces performance of fixing materials).
- Reducing the drill dust prevents jamming when drilling therefore provides a faster and frictionless drilling progress.
- Immediate extraction of drilling dust at the drill tip for a clean and healthy work place.
- Centering tip allows for accurate positioning on uneven surfaces reducing slip.

14

Characteristics



Technical data

Hollow drill bit FHD



FHD



Detail:
Top of drill FHD
Ø 12 - 14 mm



Detail:
Top of drill FHD
Ø 16 - 18 mm
Top of drill FHD Max
Ø 16 - 35 mm

Item	Item No.	Drill hole diameter d_0 [mm]	Working length [mm]	Total length l [mm]	Type of packaging	Contents	Sales unit [pcs]
FHD 12/200/330	546597	12	200	330	Plastic clip	1	1
FHD 14/250/380	546598	14	250	380	Plastic clip	1	1
FHD 16/250/380	546599	16	250	380	Plastic clip	1	1
FHD 18/320/450	546600	18	320	450	Plastic clip	1	1
FHD Max 16/400/620	546601	16	400	620	Plastic clip	1	1
FHD Max 18/400/620	546602	18	400	620	Plastic clip	1	1
FHD Max 20/400/620	546603	20	400	620	Plastic clip	1	1
FHD Max 24/400/620	546604	24	400	620	Plastic clip	1	1
FHD Max 28/600/820	546605	28	600	820	Plastic clip	1	1
FHD Max 30/600/820	546606	30	600	820	Plastic clip	1	1
FHD Max 35/650/870	546607	35	650	870	Plastic clip	1	1

Stone drill bit D-S

Universal masonry drill bit for impact and rotary drilling in masonry and natural stone



Applications

- For regular drilling especially in stone and masonry

Advantages

- 130° carbide cutting edge for long service life, very heat resistant.
- Robust version in accordance with DIN 8039, roll forged.
- Optimum drill dust removal through special spiral geometry.
- Suitable for rotary and impact drilling.

Characteristics

14



Technical data

Stone drill bit D-S



D-S

Item	Item No.	Drill hole diameter d_0 [mm]	Working length [mm]	Total length l [mm]	Type of packaging	Contents [pcs]	Sales unit [pcs]
D-S HM 3,0x30/60 PE	542976	3	30	60	Pouch	1	1
D-S HM 4,0x38/75 PE	542977	4	38	75	Pouch	1	1
D-S HM 5,0x44/85 PE	542978	5	44	85	Pouch	1	1
D-S HM 6,0x54/100 PE	542979	6	54	100	Pouch	1	1
D-S HM 6,0x135/200 PE	551390	6	135	200	Pouch	1	1
D-S HM 7,0x54/100 PE	542980	7	54	100	Pouch	1	1
D-S HM 8,0x67/120 PE	542981	8	67	120	Pouch	1	1
D-S HM 8,0x135/200 PE	542991	8	135	200	Pouch	1	1
D-S HM 10,0x135/200 PE	542992	10	135	200	Pouch	1	1
D-S HM 10,0x67/120 PE	542982	10	67	120	Pouch	1	1
D-S HM 12,0x85/150 PE	542983	12	85	150	Pouch	1	1
D-S HM 12,0x135/200 PE	542993	12	135	200	Pouch	1	1
D-S HM 13,0x85/150 PE	542984	13	85	150	Pouch	1	1
D-S HM 14,0x85/150 PE	542985	14	85	150	Pouch	1	1
D-S HM 15,0x85/150 PE	542986	15	85	150	Pouch	1	1
D-S HM 16,0x85/150 PE	542987	16	85	150	Pouch	1	1
D-S HM 18,0x100/160 PE	542988	18	100	160	Pouch	1	1
D-S HM 20,0x100/160 PE	542989	20	100	160	Pouch	1	1
D-S Set 4-10mm 5pcs P	543025	4-5-6-8-10	—	—	Plastic cassette	5	1
D-S Set 3-10mm 8pcs P	543027	3-10	—	—	Plastic cassette	8	1

Premium chisel FCP

Premium Chisel with SDS Plus and SDS Max shank for maximum performance and lifetime



Applications

Suitable for creating holes, slots and installation paths as well as breakthroughs in:

- Concrete
- Masonry
- Natural stone

Advantages

- Extended working tip in comparison to the standard chisel for an increased lifetime.
- Self-sharpening design for economical working and reducing downtime.
- Advanced 'jam protection' for reduced friction.
- Specially designed working tip increases the performance and ensures a high removal of material.

Characteristics



Technical data

Premium chisel FCP						
Item	Item No.	Type	Length L [mm]	Width B [mm]	Contents [pcs]	Sales unit [pcs]
FCP Pointed 250	546314	Pointed	250	—	1	1
FCP Flat 20/250	546315	Flat	250	20	1	1
FCP Spade 40/250	546316	Spade	250	40	1	1
FCP Max Pointed 400	546317	Pointed	400	—	1	1
FCP Max Flat 25/400	546318	Flat	400	25	1	1
FCP Max Spade 50/380	546319	Spade	380	50	1	1
FCP Set	546320	Pointed, Flat, Spade	—	—	3	1
FCP Max Set	546321	Pointed, Flat, Spade	—	—	3	1

Standard chisel



Applications

Suitable for creating holes, slots and installation paths in:

- Concrete
- Masonry
- Natural stone

Advantages

- The SDS Plus and SDS Max drill chuck for the chisel enable the use with professional hammer drilling machines and ensure proven and safe transfer of force.
- The use of a high quality, specially hardened steel with surface protection increases the life span of the tools.
- The high oscillation endurance allows for high work comfort and contributes to the achievement of clean results.

Characteristics

14



Technical data

Standard chisel									
SDS Plus and SDS Max Pointed		SDS Plus and SDS Max Flat		SDS Plus and SDS Max Spade		SDS Plus and SDS Max Hollow		SDS Plus and SDS Max Tile	
Item	Item No.	Type	Length L [mm]	Width B [mm]	Contents [pcs]	Sales unit [pcs]			
SDS Plus Pointed 250	504277	Pointed	250	12	1	1			
SDS Max Pointed 280	504281	Pointed	280	16	1	1			
SDS Max Pointed 400	504282	Pointed	400	20	1	1			
SDS Max Pointed 600	504283	Pointed	600	27	1	1			
SDS Plus Flat 20/250	504278	Flat	250	20	1	1			
SDS Max Flat 25/280	504284	Flat	280	25	1	1			
SDS Max Flat 25/400	504286	Flat	400	25	1	1			
SDS Max Flat 25/600	504287	Flat	600	25	1	1			
SDS Plus Scaling 40/250	504279	Spade	250	40	1	1			
SDS Max Scaling 50/400	504288	Spade	400	50	1	1			
SDS Max Scaling 80/300	504290	Spade	300	80	1	1			
SDS Max Scaling 115/350	504291	Spade	350	115	1	1			
SDS Plus Hollow 22/250	504280	Hollow	250	22	1	1			
SDS Max Hollow 26/300	504293	Hollow	300	26	1	1			
SDS Plus Tile scaling 40/250	531437	Tile scaling	250	40	1	1			
SDS Max Tile Scaling 50/400	504295	Tile scaling	400	50	1	1			

ProfiBit FPB

The all-rounding bit within convincing quality



Advantages

- The bits manufactured from special steel with high hardness degree are suitable for both hand driven and machine guided applications.
- The perfect fitting inside screws ensures working with low-wear of the product and consequently long lifetime and clean working results.
- The profile guarantees an ideal connection for an optimal power and torque transmission that prevents damages of the surface or the screw-heads.
- Also available as clearly arranged bit-set with 10 or 32pcs including bit holder.

Applications

Number of internal drives in various profile sizes, such as:

- PH, PZ cross-slot
- TX star recess
- Suitable for ¼" drives

Technical data

ProfiBit FPB



Item	Item No.	Drive	Length L [mm]	Contents	Sales unit [pcs]
FPB TX 25 ProfiBit W5	517693	TX25	50	5	1
FPB TX 30 90 mm ProfiBit W1	542369	TX30	90	1	1
FPB TX 30 150 mm ProfiBit W1	542372	TX30	150	1	1
FPB TX 40 90 mm ProfiBit W1	542370	TX40	90	1	1
FPB TX 40 150 mm ProfiBit W1	542373	TX40	150	1	1
FPB TX 50 ProfiBit W1	557839	TX50	25	1	1
FPB TX 50 90 mm ProfiBit W1	542371	TX50	90	1	1
FPB PH 2 Drywall W 1	557840	PH 2	25	1	1
FPB PZ 2 50mm ProfiBit W1	557842	PZ2	50	1	1
FPB PZ 4 ProfiBit W1	557843	PZ 4	38	1	1
FPB TX 10 ProfiBit W10	557845	TX10	25	10	1
FPB TX 15 ProfiBit W10	557846	TX15	25	10	1
FPB TX 20 ProfiBit W10	557847	TX20	25	10	1
FPB TX 25 ProfiBit W10	557848	TX25	25	10	1
FPB TX 30 ProfiBit W10	557849	TX30	25	10	1
FPB TX 40 ProfiBit W10	557850	TX40	25	10	1
FPB PH 1 ProfiBit W10	557851	PH1	25	10	1
FPB PH 2 ProfiBit W10	557852	PH 2	25	10	1
FPB PH 3 ProfiBit W10	557853	PH3	25	10	1
FPB PZ 1 ProfiBit W10	557854	PZ1	25	10	1
FPB PZ 2 ProfiBit W10	557855	PZ2	25	10	1
FPB PZ 3 ProfiBit W10	557856	PZ3	25	10	1

DiamondBit FDB

The non-slip bit



Advantages

- The coating with diamond-particles ensures the best possible power-transfer and prevents the bit tip from slipping out of the screw head.
- The diamond-coated bit with a high hardness grade guarantees the greatest service life and corrosion resistance.
- The torsion zones created by the tapered bit cross-section offers relief in the case of extreme loads. For a more effortless installation and maximum operating efficiency.
- The high dimensional accuracy enables an optimum bit fit for clean results and a long lifetime.

Applications

Number of internal drives in various profile sizes, such as:

- PH, PZ cross-slot
- TX star recess
- Suitable for ¼" drives

Technical data

DiamondBit FDB



FDB TX

FDB PH

FDB PZ

14

Item	Item No.	Drive	Length L [mm]	Contents	Sales unit [pcs]
FDB TX 10 DiamondBit W10	557857	TX10	25	10	1
FDB TX 15 DiamondBit W10	557858	TX15	25	10	1
FDB TX 20 DiamondBit W10	557859	TX20	25	10	1
FDB TX 25 DiamondBit W10	557860	TX25	25	10	1
FDB TX 30 DiamondBit W10	557861	TX30	25	10	1
FDB TX 40 DiamondBit W10	557862	TX40	25	10	1
FDB PH 1 DiamondBit W10	557863	PH1	25	10	1
FDB PH 2 DiamondBit W10	557864	PH 2	25	10	1
FDB PH 3 DiamondBit W10	557865	PH3	25	10	1
FDB PZ 1 DiamondBit W10	557866	PZ1	25	10	1
FDB PZ 2 DiamondBit W10	557867	PZ2	25	10	1
FDB PZ 3 DiamondBit W10	557868	PZ3	25	10	1

MaxxBit FMB

The ultimate torsion-bit



Advantages

- The ultimate solution for extreme installation torques. Ideal for usage in high-performance power and impact tools.
- Optimal geometry of the profile guarantees unique performance and durability for sophisticated applications and users.
- The elastic torsion zone releases at extreme loads to ensure a gentle working and maximum operating efficiency.
- The high dimensional accuracy allows for an ideal fit. For clean results and a long lifetime.

Applications

Number of internal drives in various profile sizes, such as:

- TX star recess
- Suitable for ¼" drives

Technical data

MaxxBit FMB



FMB TX

Item	Item No.	Drive	Length L [mm]	Contents	Sales unit [pcs]
FMB TX10 MaxxBit W 5	533154	TX10	29	5	1
FMB TX15 MaxxBit W 5	533155	TX15	29	5	1
FMB TX20 MaxxBit W 5	533156	TX20	29	5	1
FMB TX25 MaxxBit W 5	533157	TX25	29	5	1
FMB TX30 MaxxBit W 5	533158	TX30	29	5	1
FMB TX40 MaxxBit W 5	533159	TX40	29	5	1

14

BitHolder FBH

The bit holder for rapid bit exchange



Advantages

- The bit holder family for 1/4" bits with magnetic insert hold the bit securely in the drill chuck and offers a smooth installation procedure.
- Robust and slim bit holder for an easy bit exchange.
- Ideal for direct machine connection or enlargement of the bits to reach difficult areas.
- With the FBH QuickBit Slim the bit automatically locked when plugged in and provides a secure hold. By pulling back the sleeve the bit can be easily taken out.

Applications

- The bit holders for use in cylinder drill chucks

Using the BitHolder FBH



14

Technical data

BitHolder FBH



FBH BitHolder

FBH QuickBit Slim

Item	Item No.	Drive	Length L [mm]	Contents [pcs]	Sales unit [pcs]
FBH BitHolder W1	558178	1/4"	58	1	1
FBH QuickBit Slim W1	533150	1/4"	50	1	1

BitSet

Useful bit sets for a multitude of applications



Advantages

- Universal use with most common bits as well as a bit holder in one set.
- Compact bit sets with easy handling.
- Safe and clearly arranged keeping of the content assuring a reliable usage.
- Robust and durable construction fulfilling even hardest requirements.

Applications

- The ideal bit sets for quick and efficient working
- For a high variation of applications

Technical data

BitSet



BitSet FPB Profi W10



BitSet FPB Profi W32

Item	Item No.	Contents	Sales unit [pcs]
FPB BitSet Profi W10	558179	each 1x PZ1, PZ2, PZ3, TX10, TX15, TX20, TX25, TX30, TX40, 1x Universal bit holder	1
FPB BitSet Profi W32	559121	2x PZ1, 4x PZ2, 2x PZ3, 1x TX8, 2x TX10, 1x TX15, 2x TX20, 2xTX25, 1x TX27, 1x TX30, 1x TX40, 2x PH1, 4x PH2, 2x PH3, 1x PH2 D, 1x SL4.5, 1x SL5.5, 1x SL6, 1x Universal bit holder	1

Accessories for impact driver

Ideal for use in high-performance power- and impact-tools



Advantages

- Optimal geometry of the profile guarantees unique performance and durability for complex applications and users.
- The high dimensional accuracy allows for an ideal fit. For clean results and a long lifetime.

Applications

- The ultimate solution for extreme installation torques

Technical data

Accessories for impact driver



Nut SW

Nut SW

Nut 1/2" - 1/4"

Nut 1/2" - TX 50

FPB ProfiBit TX 50 5/16"

Item	Item No.	Drive	Total length [mm]	Sales unit [pcs]
Nut SW 10	538577	1/2" / SW10	78	1
Nut SW 13	538578	1/2" / SW13	38	1
Nut SW 15	538579	1/2" / SW15	38	1
Nut SW 17	538580	1/2" / SW17	38	1
Nut SW 21	538581	1/2" / SW21	38	1
Nut 1/2" - 1/4"	553928	1/2" / 1/4"	55	1
Nut 1/2" - TX 50	553929	1/2" / TX50	55	1
FPB TX 50 5/16" ProfiBit	557844	TX50	35	1

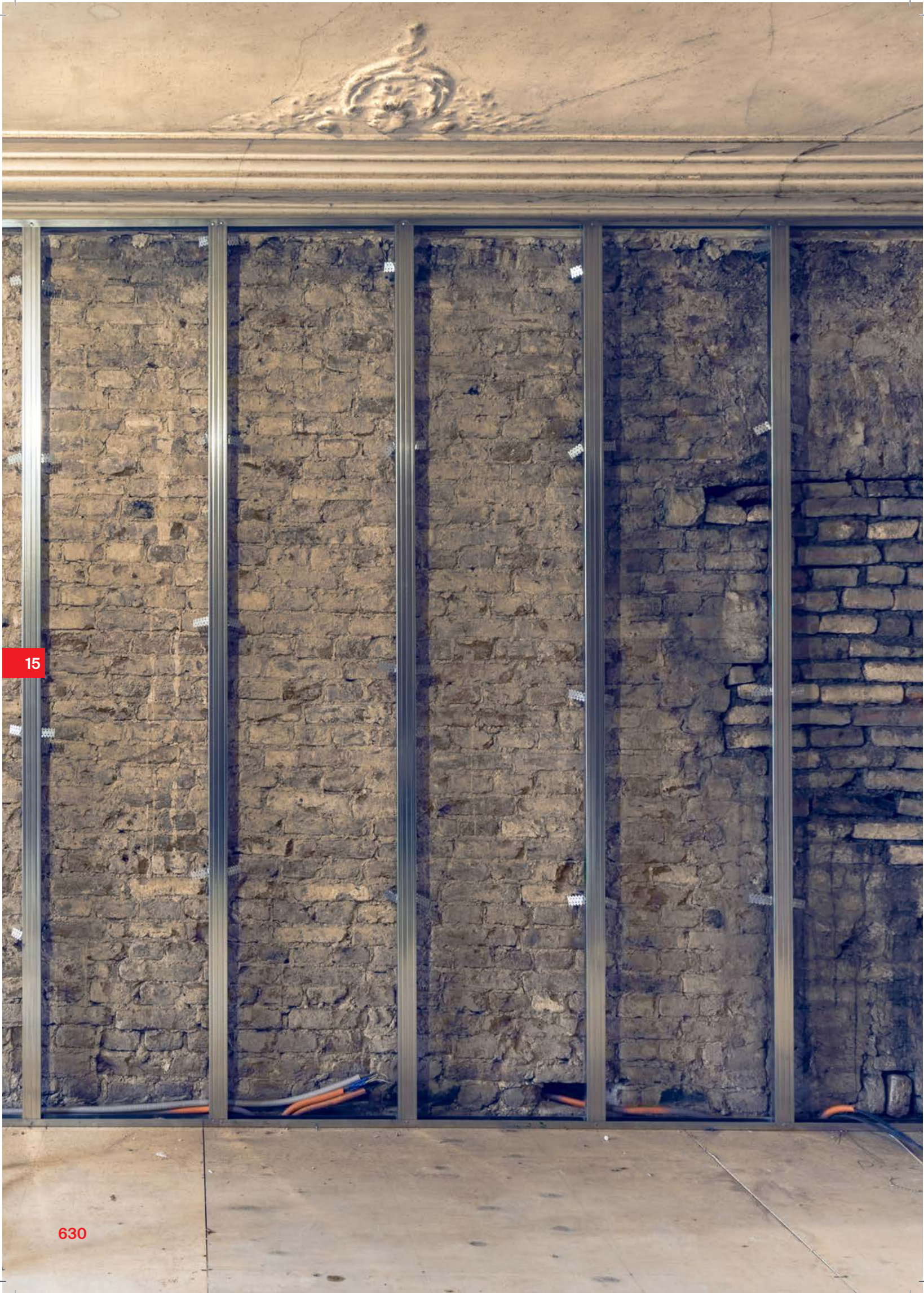

15

630

X-ON Electronics

Largest Supplier of Electrical and Electronic Components

Click to view similar products for [Hand Tools](#) category:

Click to view products by [FISCHER](#) manufacturer:

Other Similar products are found below :

[58284-1](#) [59773-1](#) [662908-1](#) [68764-0001](#) [690619-6](#) [7-354778-7](#) [768531-1](#) [810131](#) [81541-16](#) [854183-1](#) [854358-1](#) [90855-1](#) [992258-1](#) [1-21046-3](#) [121073-0047](#) [1-22278-0](#) [1-22278-2](#) [1-24954-2](#) [125529-5](#) [126513-1](#) [1-305579-8](#) [1-306027-0](#) [1320846-1](#) [1338968-2](#) [1-354779-0](#) [1-354779-2](#) [1-354779-4](#) [1424443-1](#) [1424266-1](#) [1424289-1](#) [1424444-1](#) [1532195-2](#) [1538773-2](#) [1-692134-3](#) [HT-920A-124-HTELE-RPL-KIT](#) [1976923-1](#) [1976969-1](#) [2063795-1](#) [2-21002-1](#) [2-21002-4](#) [2-21002-7](#) [2-21002-9](#) [2-21004-0](#) [229707-1](#) [911737-2](#) [91348-2](#) [925980-R](#) [301185-9](#) [983533-1](#) [1-694433-7](#)