

LEK-501

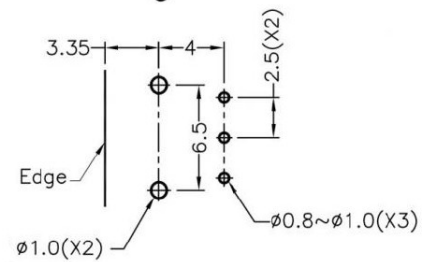
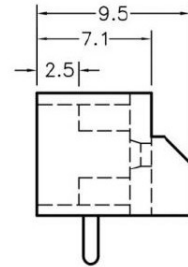
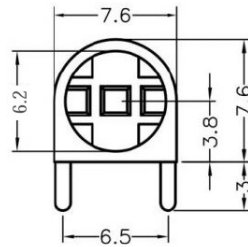

MOUNTING HOLE

MATERIAL: NYLON 66(UL)
 FLAME CLASS: 94V-2
 COLOR:BLACK
 UNIT:mm
 RECOMMEND ASSEMBLING LED SIZE : 5
 NUMBER OF ASSEMBLING LED : 1

To weld $\phi 5$ 3PIN LED on board 90 degrees, with same height, and indexing pins, but avoid crooked.

LEK-503

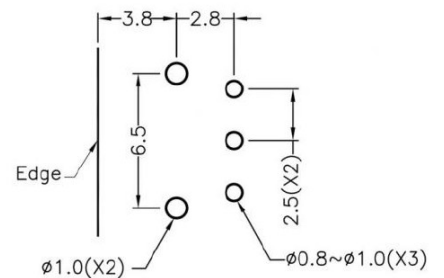
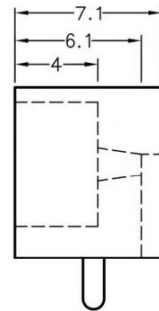
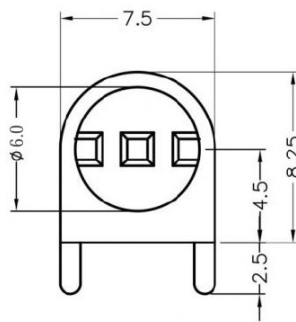
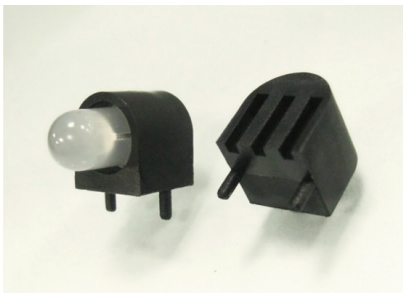

MOUNTING HOLE

FLAME CLASS: 94V-2
 COLOR:BLACK
 UNIT:mm
 RECOMMEND ASSEMBLING LED SIZE : 5
 NUMBER OF ASSEMBLING LED : 1

To weld $\phi 5$ 3PIN LED on board 90 degrees, with same height, and indexing pins, but avoid crooked.

FIX-LEK-503-7

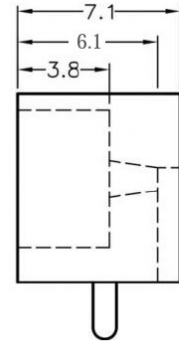
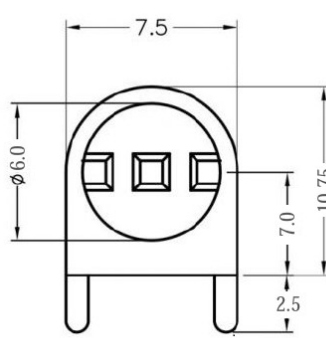

MATERIAL: NYLON 66(UL)
 FLAME CLASS: 94V-2
 COLOR:BLACK
 UNIT:mm
 RECOMMEND ASSEMBLING LED SIZE : 5
 NUMBER OF ASSEMBLING LED : 1

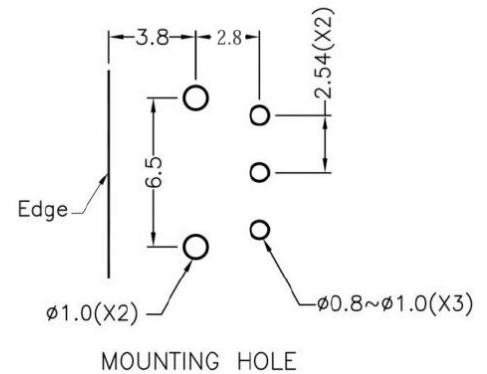

To weld $\phi 5$ 3PIN LED on board 90 degrees, with same height, and indexing pins, but avoid crooked.

FIX-LEK-503-18

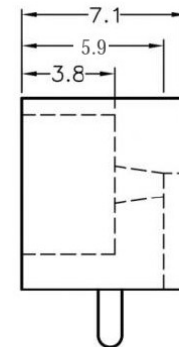
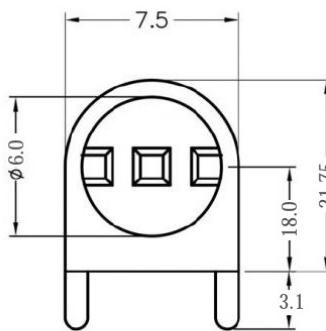

MATERIAL: NYLON 66(UL)
 FLAME CLASS: 94V-2
 COLOR:BLACK
 UNIT:mm
 RECOMMEND ASSEMBLING LED SIZE : 5
 NUMBER OF ASSEMBLING LED : 1

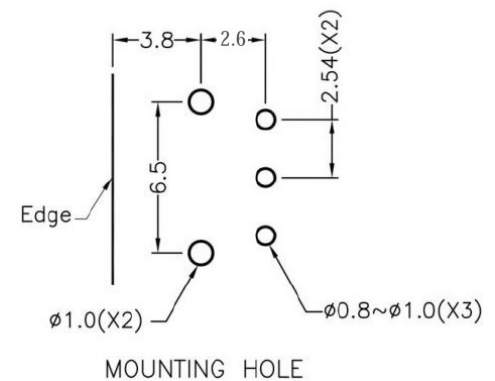

To weld $\phi 5$ 3PIN LED on board 90 degrees, with same height, and indexing pins, but avoid crooked.

FIX-LEK-505



MATERIAL: NYLON 66(UL)
 FLAME CLASS: 94V-2
 COLOR:BLACK
 UNIT:mm
 RECOMMEND ASSEMBLING LED SIZE : 5
 NUMBER OF ASSEMBLING LED : 1

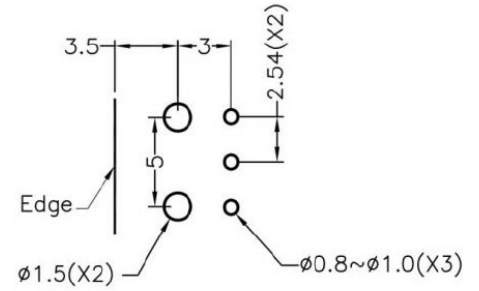
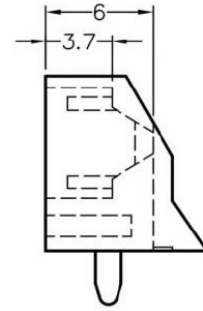
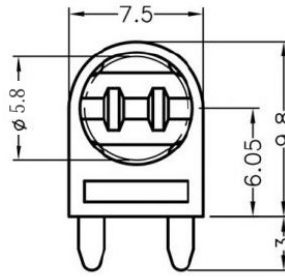

MOUNTING HOLE

To weld $\phi 5$ 3PIN LED on board 90 degrees, with same height, and indexing pins, but avoid crooked.

FIX-LEK-508



MATERIAL: NYLON 66(UL)
 FLAME CLASS: 94V-2
 COLOR:BLACK
 UNIT:mm
 RECOMMEND ASSEMBLING LED SIZE : 5
 NUMBER OF ASSEMBLING LED : 1

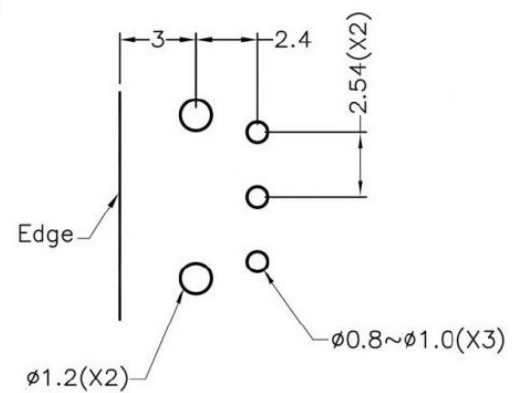
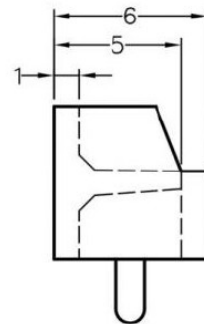
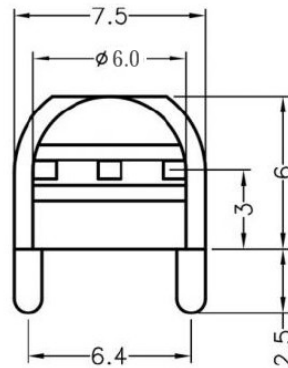

MOUNTING HOLE

To weld $\phi 5$ 3PIN LED on board 90 degrees, with same height, and indexing pins, but avoid crooked.

FIX-LEK-506



MATERIAL: NYLON 66(UL)
FLAME CLASS: 94V-2
COLOR:BLACK
UNIT:mm
RECOMMEND ASSEMBLING LED SIZE : 5
NUMBER OF ASSEMBLING LED : 1

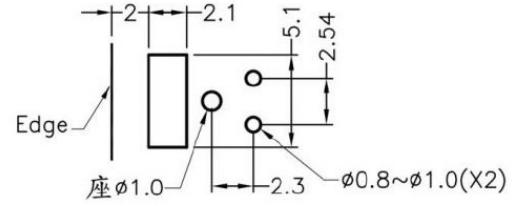
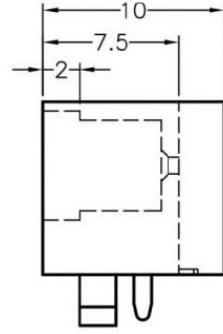
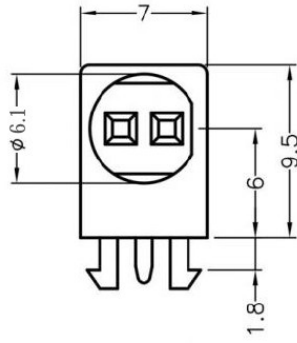

MOUNTING HOLE

To weld $\phi 5$ LED on board 90 degrees, with same height, and indexing pins, but avoid crooked.

X-ON Electronics

Largest Supplier of Electrical and Electronic Components

Click to view similar products for [LED Mounting Hardware](#) category:

Click to view products by [Fix & Fasten](#) manufacturer:

Other Similar products are found below :

[00624750](#) [990-4901-010](#) [990-8115-001](#) [FIX-LED-306B](#) [CMP22](#) [C-101](#) [LDN51-125SL/BT](#) [SN3486](#) [26-0053](#) [TC4-R-](#) [SLQ16](#) [LM6-2](#)
[LM12-1](#) [LM10-1](#) [L-22N](#) [SMBPPF1](#) [SMBPPFB](#) [C-R25-SR](#) [CM00624900](#) [LEDS2-8-26](#) [LEDS2E-10-01](#) [LEDS2M-240-01](#) [ZCH-200-I](#)
[RNG132](#) [FIX-LEDH-10](#) [FIX-LEDH-10.5](#) [FIX-LEDH-11](#) [FIX-LEDH-11.5](#) [FIX-LEDH-12](#) [FIX-LEDH-14](#) [FIX-LEDH-17](#) [FIX-LEDH-4.5](#)
[FIX-LEDH-9.5](#) [FIX-LEDS-1.5](#) [FIX-LEDS-3.5](#) [FIX-LEDT-11](#) [FIX-LEDT-9](#) [SQLEDS2-4-26](#) [7382](#) [CMC285BLK](#) [CNXDX4624](#)
[CNXDX4608](#) [CNXDF4608](#) [CNXCE4118](#) [4740](#) [CNXCX4104](#) [CNXCE4124](#) [CNXCE4112](#) [CNX460-X02-4-1-24](#) [CNX440-X02-4-1-24](#)