





















Spring Force (xx)

Preload	Rated Force	Code
		xx
0,3 N	0,8 N	08
0,9 N	1,5 N	15
1,5 N	3,0 N	30
2,0 N	5,0 N	50

	Ø 0,70	30.102.07.xx
	Ø 1,30	30.102.13.xx
	Ø 1,30	30.103.13.xx
	Ø 2,00	30.103.20.xx
	Ø 3,00	30.03.30.xx
	Ø 1,90	30.104.19.xx
	Ø 1,30	30.05.13.xx
	Ø 1,50	30.05.15.xx
	Ø 2,00	30.05.20.xx
	Ø 1,30	30.06.13.xx
	Ø 1,60	30.106.16.xx
	Ø 2,00	30.106.20.xx
	Ø 1,30	30.107.13.xx
	Ø 1,30	30.108.13.xx
	Ø 2,00	30.108.20.xx
	Ø 2,70 / 2,30	30.308.27.xx
	Ø 1,30	30.10.13.xx
	Ø 1,80	30.10.18.xx
	Ø 1,30	30.118.13.xx
	Ø 2,00	30.61.20.xx



For **XXLonglife-Nanocoating**
order as **30X**

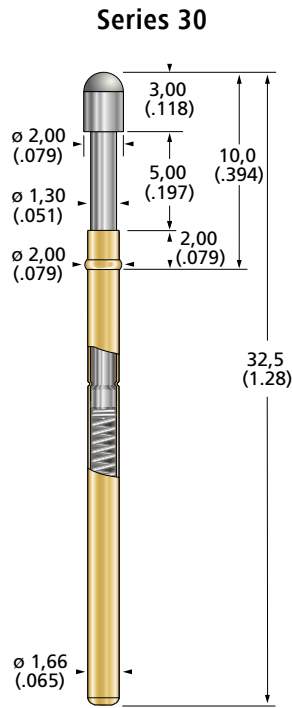

Series 30

Technical Data

Overall Length	32,50mm
Minimum Centre Spacing	2,54 mm
Maximum Travel	5,00 mm
Working Travel	3,30 mm
Temperature Range from	-55°C
Up to	+120°C
Typical Resistance	20 mΩ
Current Load rated/max.	3,0 / 4,0 A

Materials

Plunger	CuBe or steel, gold plated
Barrel	Nickel silver, gold plated
Spring	Music wire, silver plated

The standard metric series for many applications such as manual handling adapter, connector test heads etc. For matching receptacles, see page 42.

RECEPTACLES SERIES

30 / 31 / 40 / 41 / 42 / 44 / 49

D 30.01

Spacer tube 1 mm

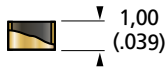

D 30.02

Spacer tube 2 mm



D 30.03

Spacer tube 3 mm

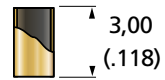

S 30.00-C

Open Crimp End

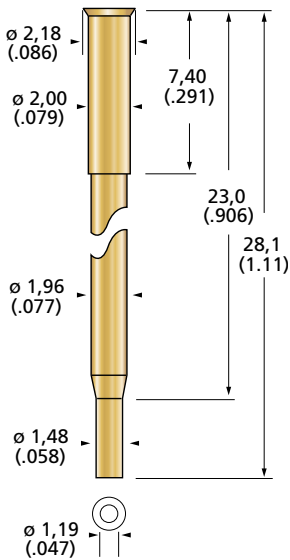

S 30.00-L

Solder Cup

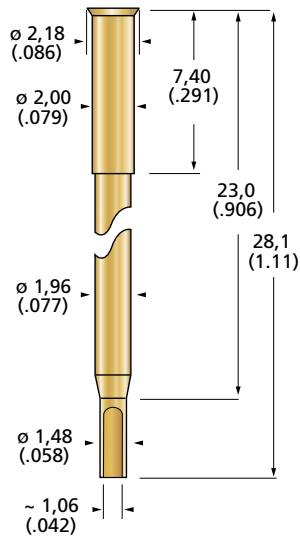

S 30.00-W

Wire-Wrap-Post

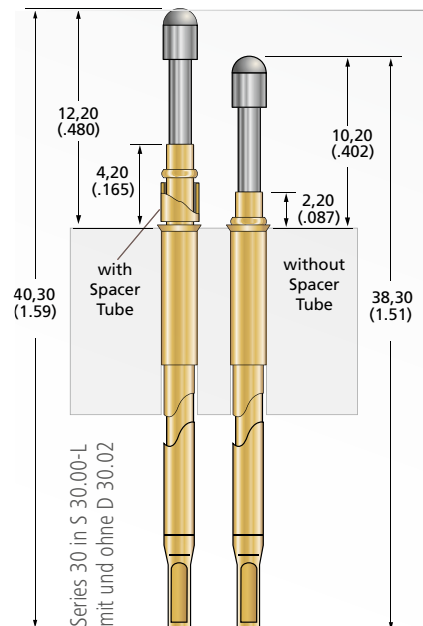
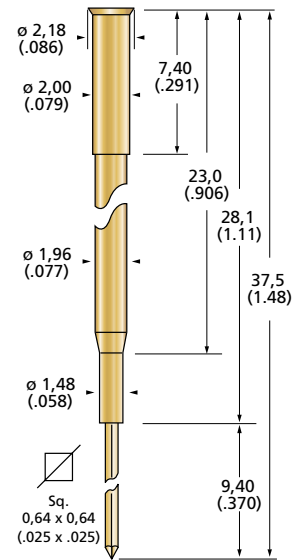

FIXTURING EXAMPLE

ICT/FCT RECEPTACLES
SERIES 30 / 31 / 40 / 41 / 42 / 44 / 49

Pitch
 $\geq 2,54$ mm ≥ 100 mil

X-ON Electronics

Largest Supplier of Electrical and Electronic Components

Click to view similar products for [Contact Probes](#) category:

Click to view products by [FIXTEST](#) manufacturer:

Other Similar products are found below :

[CT5253](#) [S-4-C-5-G S/C](#) [SS-75-B-2.4-G](#) [ICT-100-J-17-G](#) [300106-000-1103](#) [ICT-100-A-8-G S/C](#) [ICT-075-B-10-G-S S/C](#) [S-2-D-8.3-G D/C](#)
[ICT-100-T-8-G S/C](#) [GSS-4-7-G](#) [S-0-B9-2.5-G S/C](#) [SS-40-J-2.4-G D/C](#) [S-0-V-3.7-G S/C](#) [SX-1-U-6.6-G D/C](#) [SS-50-J-5.1-G S/C](#) [SS-40-J-1.8-](#)
[G-N/L D/C](#) [SS-3-7-G S/C W/HOLE .373 OAL](#) [SS-10-7-G S/C W/HOLE .373 OAL](#) [SS-1-7-G S/C W/HOLE .385 OAL](#) [SHE-5-H-18.7-G](#)
[SHE-5-B-18.7-G](#) [SHE-3-A-7-G](#) [SH-4-A-10-G S/C](#) [101057-001-952](#) [S-50C-HS-4.3-DG-S](#) [S-5-F-8-G S/C SS SPGS](#) [S-5-F-16.4-G S/C](#) [S-4-K-](#)
[5-G S/C](#) [S-4-E-5-D S/C](#) [S-2-J-8.3-G D/C](#) [S-2-E-10-D D/C](#) [S-2-A-10-D D/C](#) [S-100-UR-5.5-G-S](#) [S-100-T-8-RT](#) [S-100-J-17-G](#) [S-100-HK-10-](#)
[G](#) [S-100-D-6.7-G](#) [S-100-B-3.5-G-S](#) [S-100-B-3.5-G](#) [S-1-U-6.6-D D/C .670 OAL](#) [S-1-A-6.6-D D/C .670 OAL](#) [S-075-S-3.8-RT](#) [S-075-J-3-G](#) [S-](#)
[075-B-3-G](#) [S-075-A-7-G](#) [S-00-U-1.6-G D/C SS SPG](#) [S-00-ES-2-G D/C](#) [S-0-U-3.7-D S/C](#) [RX-100-SC](#) [RH-100-WW-429](#)