















## Spring Force (xx)

Preload	Rated Force	Code
0,3 N	0,8 N	<b>08</b>
0,9 N	1,5 N	<b>15</b>
1,0 N	2,2 N	<b>22</b>
1,2 N	3,0 N	<b>30</b>
2,0 N	5,0 N	<b>50</b>

	Ø 0,70	<b>40.102.07.xx</b>
	Ø 1,30	<b>40.102.13.xx</b>
	Ø 1,30	<b>40.103.13.xx</b>
	Ø 1,90	<b>40.104.19.xx</b>
	Ø 1,50	<b>40.05.15.xx</b>
	Ø 1,30	<b>40.08.13.xx</b>
	Ø 1,60	<b>40.08.16.xx</b>
	Ø 2,00	<b>40.108.20.xx</b>
	Ø 1,30	<b>40.10.13.xx</b>
	Ø 1,80	<b>40.10.18.xx</b>
	Ø 1,30	<b>40.118.13.xx</b>
	Ø 1,30	<b>40.146.13.xx</b>
	Ø 1,60	<b>40.146.16.xx</b>
	Ø 1,50	<b>40.174.15.xx</b>



For **XXLonglife-Nanocoating**  
order as **40X**

## Series 40

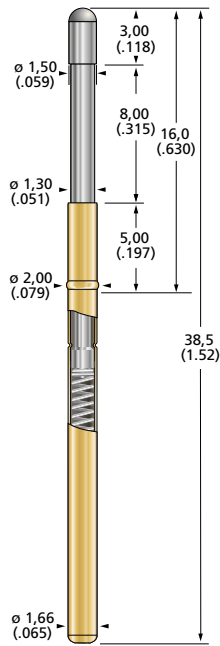

## Series 40

### Technical Data

Overall Length	38,50 mm
Minimum Centre Spacing	2,54 mm
Maximum Travel	8,00 mm
Working Travel	5,30 mm
Temperature Range from	-55°C
Up to	+120°C
Typical Resistance	20 mΩ
Current Load rated/max.	3,0 / 4,0 A

### Materials

Plunger	CuBe or steel, gold plated
Barrel	Nickel silver, gold plated
Spring	Music wire, silver plated

Longer standard series with 8 mm max. travel and 16 mm extension height. These dimensions are common standard in many test fixtures from different manufacturers.

The Series 40 uses the receptacles of the series 30 on page 42. Further head styles available on request.

# RECEPTACLES SERIES

## 30 / 31 / 40 / 41 / 42 / 44 / 49

### D 30.01

Spacer tube 1 mm

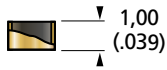

### D 30.02

Spacer tube 2 mm



### D 30.03

Spacer tube 3 mm

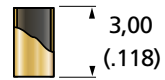

### S 30.00-C

Open Crimp End

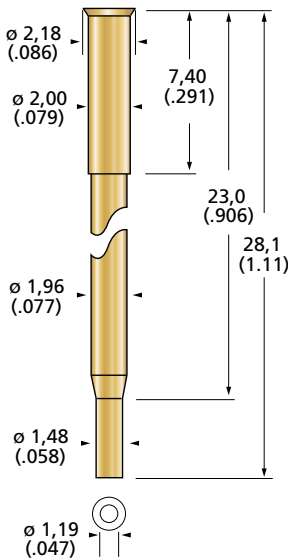

### S 30.00-L

Solder Cup

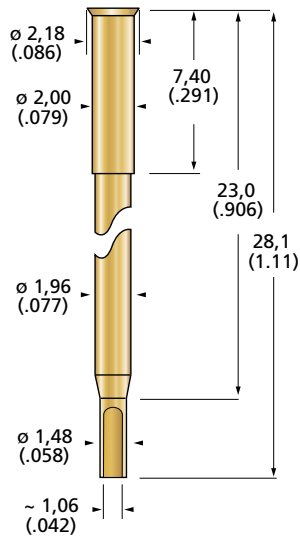

### S 30.00-W

Wire-Wrap-Post

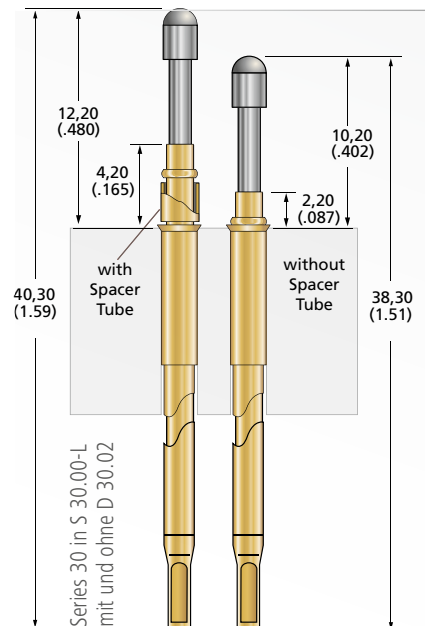
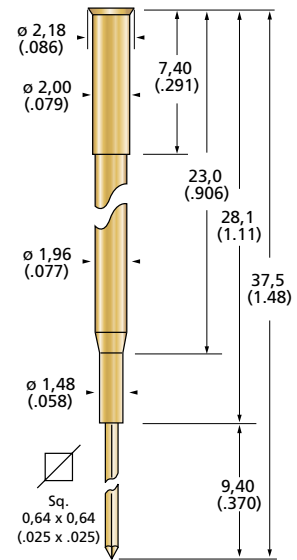

FIXTURING EXAMPLE

ICT/FCT RECEPTACLES  
SERIES 30 / 31 / 40 / 41 / 42 / 44 / 49

Pitch  
 $\geq 2,54$  mm  $\geq 100$  mil

## X-ON Electronics

Largest Supplier of Electrical and Electronic Components

*Click to view similar products for [Contact Probes](#) category:*

*Click to view products by [FIXTEST](#) manufacturer:*

Other Similar products are found below :

[CT5253](#) [CT5082](#) [100039-033-958](#) [100077-003-0-0](#) [300122-031-1102](#) [R-2-RP-375](#) [S-4-C-5-G S/C](#) [300122-056-0203](#) [SS-75-B-2.4-G](#) [S-100-U-10-G-S](#) [SS-75-C-4.9-D D/C .620 OAL](#) [100165-033-952](#) [300106-000-1103](#) [100024-002-942](#) [SS-75-E-4.9-D D/C .620 OAL](#) [SX-0-U-2.2-G D/C](#) [101506-000](#) [101740-028-948](#) [ICT-100-V8-8-G S/C](#) [ICT-100-A-8-G S/C](#) [ICT-075-B-10-G-S S/C](#) [S-2-D-8.3-G D/C](#) [GSS-19-7-G S/C OAL](#) [ICT-100-T-8-G S/C](#) [GSS-4-7-G](#) [SS-40-J-2.4-G D/C](#) [S-0-A-2.2-D 660 S/C](#) [SS-50-J-3.3-D S/C](#) [S-0-V-3.7-G S/C](#) [SX-2-B-7-G D/C](#) [SX-1-U-6.6-G D/C](#) [SX-1-C-6.6-G D/C](#) [SS-75-D-4.9-D D/C .620 OAL](#) [SS-50-J-5.1-G S/C](#) [SS-50-E-2.9-G S/C](#) [SS-40-J-1.8-G-N/L D/C](#) [SS-3-7-G S/C W/HOLE .373 OAL](#) [SS-18-7-G S/C W/HOLE .405 OAL](#) [SS-10-7-G S/C W/HOLE .373 OAL](#) [SS-1-7-G S/C W/HOLE .385 OAL](#) [SHE-5-H-18.7-G](#) [SHE-5-B-18.7-G](#) [SHE-5-A-18.7-G](#) [SHE-3-A-7-G](#) [SH-4-A-10-G S/C](#) [101057-001-952](#) [S-50C-HS-4.3-DG-S](#) [S-5-F-8-G S/C SS](#) [SPGS](#) [S-5-F-16.4-G S/C](#) [S-4-K-5-G S/C](#)