





































Spring Force (xx)

Preload	Rated Force	Code
0,3 N	1,0 N	10
0,35 N	1,5 N	15
0,4 N	2,0 N	20
0,5 N	2,5 N	25
0,8 N	3,0 N	30

	Ø 0,60	100.101.06.xx
	Ø 0,90	100.102.09.xx
	Ø 1,50	100.03.15.xx
	Ø 2,30	100.203.23.xx
	Ø 1,50	100.04.15.xx
	Ø 2,00	100.04.20.xx
	Ø 2,10	100.304.21.xx
	Ø 0,90	100.05.09.xx
	Ø 1,30	100.05.13.xx
	Ø 1,50	100.05.15.xx
	Ø 1,00	100.106.10.xx
	Ø 1,30	100.106.13.xx
	Ø 1,50	100.06.15.xx
	Ø 1,40	100.07.14.xx
	Ø 0,90	100.08.09.xx
	Ø 1,30	100.08.13.xx
	Ø 1,50	100.08.15.xx
	Ø 1,50	100.108.15.xx
	Ø 2,00	100.08.20.xx
	Ø 2,50	100.08.25.xx
	Ø 3,00	100.08.30.xx
	Ø 3,20	100.08.32.xx
	Ø 2,30 / 1,50	100.308.23.xx
	Ø 3,20 / 2,70	100.308.32.xx
	Ø 3,90 / 3,30	100.308.39.xx
	Ø 4,10 / 3,00	100.308.41.xx
	Ø 0,90	100.112.09.xx
	Ø 1,50	100.112.15.xx
	Ø 1,70	100.112.17.xx
	Ø 1,50	100.113.15.xx
	Ø 0,90	100.118.09.xx
	Ø 1,50	100.118.15.xx
	Ø 0,90	100.120.09.xx
	Ø 1,50	100.20.15.xx
	Ø 2,00	100.20.20.xx
	Ø 0,90	100.123.09.xx

Series 100

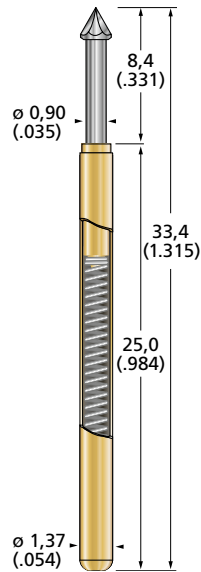

Series 100

Technical Data

Overall Length	33,40 mm
Minimum Centre Spacing	2,54 mm
Maximum Travel	6,40 mm
Working Travel	4,20 mm
Temperature Range from	-55°C
Up to	+120°C
Typical Resistance	20 mΩ
Current Load rated/max.	3,0 / 4,0 A





Materials

Plunger	CuBe or steel, gold plated
Barrel	Nickel silver, gold plated
Spring	Music wire, gold plated

The 100 Series is THE international standard type for the 2.54 mm (100 mils). The list of head styles is extended continuously, so please ask our sales team! We design and produce tailor-made extras on demand!

Combined with probes series for larger and smaller grid spacing but with the same stroke length: Series 071 for 1.27 mm pitch, Series 75 for 1.9 mm pitch, Series 26, 27 and 28 for the centre spaces of 3.20 mm, 4.00 mm and 4.80 mm.

An overview of available receptacles you find on page 34.

	Ø 0,90	100.124.09.xx
	Ø 0,90	100.126.09.xx
	Ø 1,50	100.162.15.xx
	Ø 0,50	100.66.05.xx
	Ø 0,80	100.166.08.xx



For **XXLonglife-Nanocoating** order as **100X**

**ICT / FCT
TEST PROBES**

RECEPTACLES SERIES 100 / 101 / 125

S 100.00-C
Open Crimp End

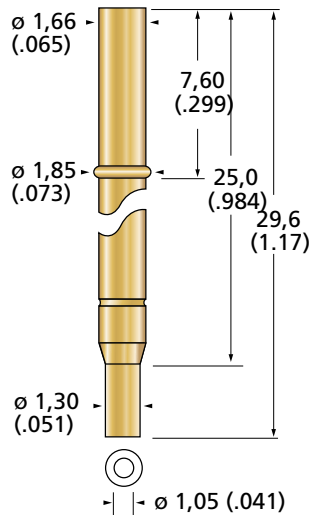

S 100.00-L
Solder Cup

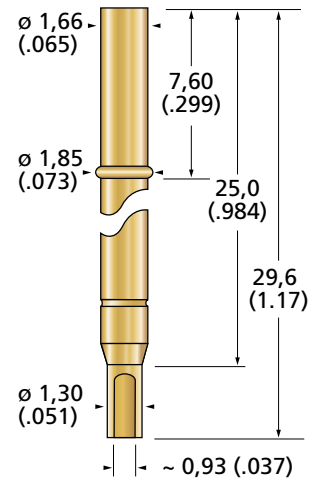

SERIES 100 receptacles are used as well for SERIES 101 and 125. Further types with other terminations and press-ring locations available on request.

S 100.00-W
Wire-Wrap-Post

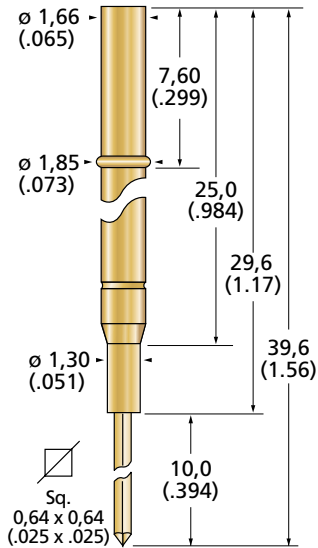

S 100.10-W
Wire-Wrap-Post

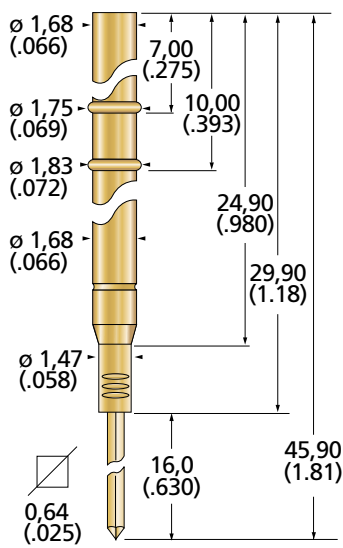

S 100.04-WI
Wire-Wrap-Post

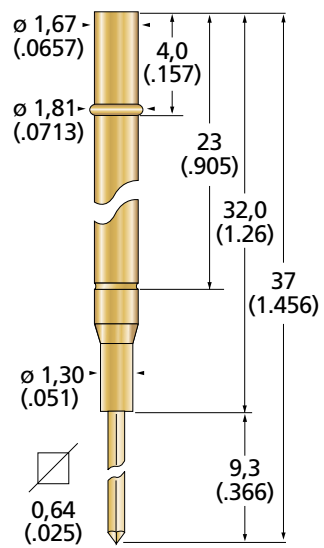

S 100.05-WI
Wire-Wrap-Post

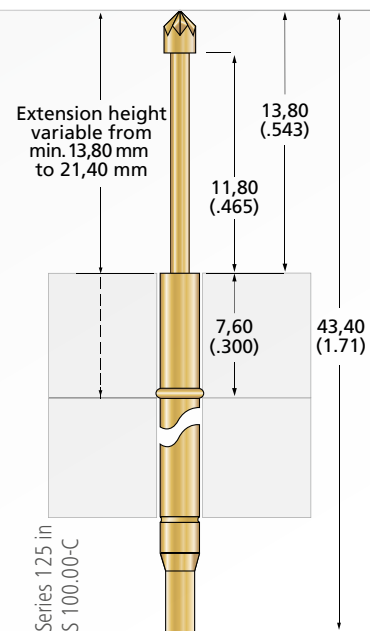
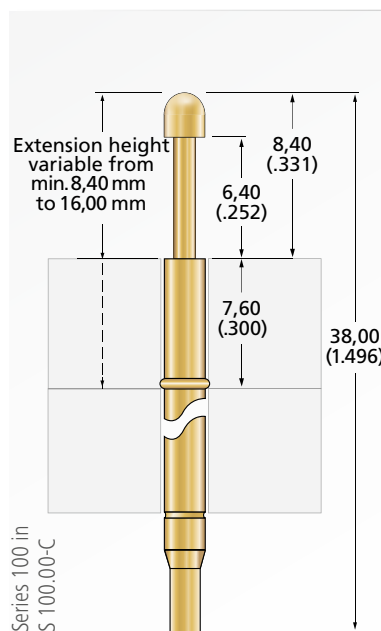
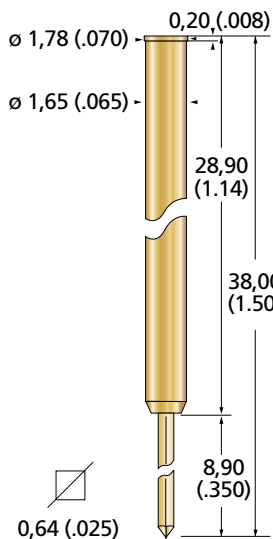

FIXTURING EXAMPLE

ICT/FCT RECEPTACLES
SERIES 100 / 101 / 22 / 125

Pitch
≥ 2,54 mm ≥ 100 mil

X-ON Electronics

Largest Supplier of Electrical and Electronic Components

Click to view similar products for [Contact Probes](#) category:

Click to view products by [FIXTEST](#) manufacturer:

Other Similar products are found below :

[CT5253](#) [S-4-C-5-G S/C](#) [SS-75-B-2.4-G](#) [ICT-100-J-17-G](#) [300106-000-1103](#) [ICT-100-A-8-G S/C](#) [ICT-075-B-10-G-S S/C](#) [S-2-D-8.3-G D/C](#)
[ICT-100-T-8-G S/C](#) [GSS-4-7-G](#) [S-0-B9-2.5-G S/C](#) [SS-40-J-2.4-G D/C](#) [S-0-V-3.7-G S/C](#) [SX-1-U-6.6-G D/C](#) [SS-50-J-5.1-G S/C](#) [SS-40-J-1.8-](#)
[G-N/L D/C](#) [SS-3-7-G S/C W/HOLE .373 OAL](#) [SS-10-7-G S/C W/HOLE .373 OAL](#) [SS-1-7-G S/C W/HOLE .385 OAL](#) [SHE-5-H-18.7-G](#)
[SHE-5-B-18.7-G](#) [SHE-3-A-7-G](#) [SH-4-A-10-G S/C](#) [101057-001-952](#) [S-50C-HS-4.3-DG-S](#) [S-5-F-8-G S/C SS SPGS](#) [S-5-F-16.4-G S/C](#) [S-4-K-](#)
[5-G S/C](#) [S-4-E-5-D S/C](#) [S-2-J-8.3-G D/C](#) [S-2-E-10-D D/C](#) [S-2-A-10-D D/C](#) [S-100-UR-5.5-G-S](#) [S-100-T-8-RT](#) [S-100-J-17-G](#) [S-100-HK-10-](#)
[G](#) [S-100-D-6.7-G](#) [S-100-B-3.5-G-S](#) [S-100-B-3.5-G](#) [S-1-U-6.6-D D/C .670 OAL](#) [S-1-A-6.6-D D/C .670 OAL](#) [S-075-S-3.8-RT](#) [S-075-J-3-G](#) [S-](#)
[075-B-3-G](#) [S-075-A-7-G](#) [S-00-U-1.6-G D/C SS SPG](#) [S-00-ES-2-G D/C](#) [S-0-U-3.7-D S/C](#) [RX-100-SC](#) [RH-100-WW-429](#)