



Flambeau®

Distinctive Packaging For Quality Brands And Products™

Buyer's Guide

BIOPRO

#SCHOLASTIC

EPSON
User's Manual

GREENLEE

F

Flambeau®

Distinctive Packaging For Quality Brands And Products™

Buyer's Guide



USA BlueBook

RIDGID

VOLVO
VOLVO TRUCKS

Brake Quip

TINKER & OMEGA
MANUFACTURING LLC
Blade Changing Kit

SPEC MIX



Snap-on

LEASER

Husky

HUSKY



Single Source Solutions ... In Plastic

Flambeau® Inc. is a worldwide industry leader in thermoplastic manufacturing, specializing in both injection and blow molding. Our unique competitive advantage is the ability to offer the largest array of proprietary stock plastic packaging and storage products ... along with countless customization options.

Consider Flambeau Packaging as Your “Art to Part” Source!

Our full range of services include:

- Part design
- Mold design and fabrication
- Manufacturing and assembly
- Various product fulfillment programs
- Prototyping
- Sampling
- Custom quoting

Flambeau Inc. Profile and History

Flambeau Packaging, a division of Flambeau Inc. has been doing business since 1947. Headquartered in Baraboo, WI, we pride ourselves in being a family owned company. We foster core values such as Family, Integrity, Leadership, Teamwork and Knowledge for the pursuit of Excellence with people who care ... and who are committed to providing you professional service when you need it!

Customer Service: 1 (800) 344-5716

Our professional customer service associates are eager to help answer questions and solve problems! You can contact us toll free for guidance and great customer care.

We encourage you to examine all we have to offer at our website: flambeaucases.com

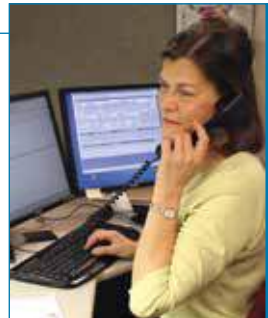

Follow us on Facebook, Twitter and Instagram.



Overview: Flambeau Capabilities

Express ServiceSM



Offers one unit to single carton quantities of in-stock cases to be shipped within 24 business hours. Qualifying products are marked with a **E** symbol.



Blue DiamondSM Program



Offers select in-stock products to be custom decorated with hot stamp in low volume quantities. Qualifying products are marked with a **F** symbol.



Special Order / Non-Stock Products



Most products are in-stock and ready to ship, but non-stock products are marked in the catalog as **S** and are available with reasonable lead-times.

ECO Friendly Products



Flambeau's Packaging Divisions offers 100% recyclable storage cases and boxes. Ensures customer disposal of product lessens their carbon footprint on the environment & provides additional value to items. Can be manufactured and made available in most products with production quantities as low as 1,000 pieces.

Canvas / Soft-Sided Solutions

Now offering canvas bags and cases fully customized to your specifications. Choose your ideal solution in fabric. Minimum quantities apply. **S**



Great for protecting and transporting instruments, equipment, tools, small electronic devices, medical equipment, sports products, and much, much more!

Overview: Custom Decorating Capabilities

Hot Stamp Labeling

An economical way to customize with up to three colors. **Injection molded products only*



Engraving

We use lid and base inserts on our stock boxes and cases. This allows you the flexibility to insert a custom engraved company logo and/or design plate on one or both sides. **Injection or blow molded products*



In-Mold Decorating

High quality, multi-color graphic labeling. The result - better product presentation with guaranteed straight, crisp, clear graphics that are impervious to most chemicals. **Injection or blow molded products*



Labels

Adhesive-backed labels available and factory supplied. **Injection or blow molded products*



Custom Interiors

Choose from custom molded interiors or custom foam interiors for that polished and professional look.



Color Options

Flambeau offers a selection of color resins. Custom blended colors available upon request

Available Injection Molded Colors:

Taupe PMS 409C	Black PMS 6C	Gray PMS 432C	Yellow PMS 109C	Blue PMS 289C
Orange PMS 1665C	Evergreen PMS 553C	Red PMS 1805C	Translucent Blue PMS 307C	Translucent Red PMS 198C
Translucent Yellow PMS 3955C	Translucent PMS N/A	White PMS 77C	Olive Green PMS 418C	Translucent Green PMS 354C

Available Blow Molded Colors:

Orange PMS 158C	White PMS 77C	Black PMS 6C
Gray PMS 433C	Silver PMS 877C	Blue PMS 307C
Red PMS 187C	Yellow PMS 116C	Evergreen PMS 553C

Available Hot Stamp Foil Colors:

Black PMS 6C	White PMS 77C	Blue PMS 286C
Yellow Crown Roll PMS 114C	Green PMS 3308C	Platinum PMS 877C
Red PMS 186C	Gold PMS 871C	

For your convenience and order processing speed we accept:



Zerust® and Anti-Tarnish Capabilities



No Rust With Zerust!

Zerust® has proven to be the absolute best way to protect your equipment against rust and corrosion. Molded into many Flambeau® products, this patented polymer emits a harmless vapor, forming a protective layer around metal surfaces. With the

Zerust VCI (Volatile Corrosion Inhibitor) molded directly into the plastic, there is no need for messy VCI cardboard chips that lose their potency when they get wet. All Zerust products will maintain their effectiveness for five years of hassle free, long lasting protection. Look for the Zerust symbol next to those products that feature this revolutionary technology. This is just another innovation from Flambeau®... your most trusted source in storage.



Anti-Tarnish by Flambeau®

Provides safe, long-term protective storage for sterling silver items. The patented Anti-Tarnish additive forms a harmless protective layer around silver surfaces preventing tarnishing for up to five years.

Flambeau Zerust helps to increase efficiency, saves money and, most importantly, protects tools and hardware keeping them operational.



Scan to see the Zerust story



Zerust® is the oldest, most proven effective VCI, (Volatile Corrosion Inhibitor) in the industry!

Flambeau® Zerust® provides a solution to the corrosion problem. It helps to increase efficiency, saves money & most importantly protects tackle, keeping them operational.

Zerust® Molded Directly Into Product: Flambeau stocks select Super Satchels™ and Tuff Tainers® with Anti-Tarnish or Zerust molded within the product. Most products incorporating the Anti-Tarnish or Zerust features are available through our **Special Order Program** and may require certain minimum quantities.

See next page for ordering information for Anti-Tarnish and Zerust Divider Packs. These divider packs provide the same great protection molded in the “divider” for use in Flambeau Super Satchels & Tuff Tainers.

See (page 100) for more Zerust® accessories!



Dividers: General, Zerust®, Anti-Tarnish and IDS™



Zerust® Dividers:

Having Zerust molded directly into the dividers themselves, creates a harmless vapor barrier around your parts inhibiting corrosion for up to five years (see first chart).

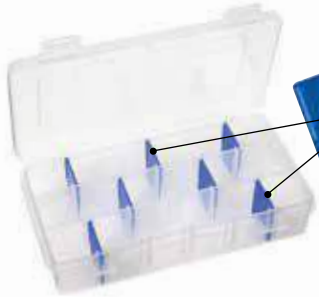

Zerust is a registered trademark of Northern Technologies International Corporation.



Anti-Tarnish Dividers:

Molded directly into the dividers forming a harmless protective layer around non-ferrous metals such as silver, gold and copper and will prevent tarnishing for up to 5 years!

To order Anti-Tarnish dividers for your specific Tuff Tainer® or Super Satchel™:

MODEL #	PAGE	SETS TO A PACK	ORDER #
T4007AT	31	12	4812DP
T5007AT	32	12	5812DP
T9101AT	80	12	5812DP

Dividers With Zerust

Order info for specific Tuff Tainers® or Super Satchels™



MODEL #	PAGE	PER PACK	ORDER #
T2003	30	15	2012ZP
T3003	30	12	3012ZP
T4007	31	12	4712ZP
T4008	31	12	4712ZP
T5007	31	12	5712ZP
T5008	32	12	5712ZP
T6004	32	12	6012ZP
T7003	32	12	7012ZP
T7004	32	12	7012ZP
T9101	80	12	5712ZP
T9007	80	12	9012ZP

Standard Dividers

Order info for specific Tuff Tainers® or Super Satchels™



MODEL #	PAGE	PER PACK	ORDER #	BULK ORDER #
T1002	30	12	1012DP	601331
T2003	30	15	2012DP	601321
T3003	30	12	3412DP	601320
T4007	31	12	4712DP	601370
T4008	31	12	4712DP	601370
T5007	31	12	5712DP	601365
T5008	32	12	5712DP	601365
T6004	32	12	6012DP	601329
T7003	32	12	7012DP	601332
T7004	32	12	7012DP	601332
T9101	80	12	5712DP	601365
T9007	80	12	9012DP	601372



Infinite Dividers System™ (IDS) Dividers:

Unique patented system that allows you to place dividers exactly where you need them...every 1/16" (0.16 cm). No wasted space!

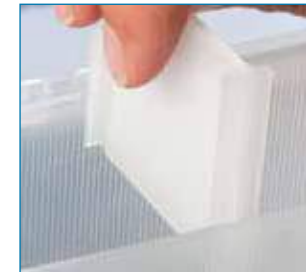

US Patent 4,838,445

To Order IDS Dividers:

MODEL #	PAGE	PER PACK	ORDER #	BULK ORDER #
T300	40	8	3108DP	601316
T600	40	8	6108DP	601308
999-2	40	8	9108DP	601310
T900	41	8	9108DP	601310

To Order IDS Dividers With ZERUST®:

T300	40	Individually Sold	601342	--
T600	40	12	6108ZR	--
999-2	40	12	9108ZR	--
T900	41	12	9108ZR	--



See What's New at Flambeau®



Distinctive Packaging For Quality Brands And Products™

SLIM LINE™ Boxes

• 4" SLIM LINE™ Box

From crafts to electronics and more, these new 4" boxes offer easy access and are great for organized storage **Page 15**



Vision 20™

View contents inside with dual capabilities of blow mold and injection mold technologies resulting in an innovative solution for packaging and merchandising! **Page 76**



Waterproof Tuff Tainers®

Clear, open core compartment boxes that are equipped with tight sealing latches and a waterproof gasket seal. **Page 33**



4" x 6", 6" x 6", 12" x 12" and 24" x 4" Boxes

Made out of Translucent, clear, acid-free polypropylene, these boxes are ideal for displaying product or quick reference of the contents inside. **Page 77**

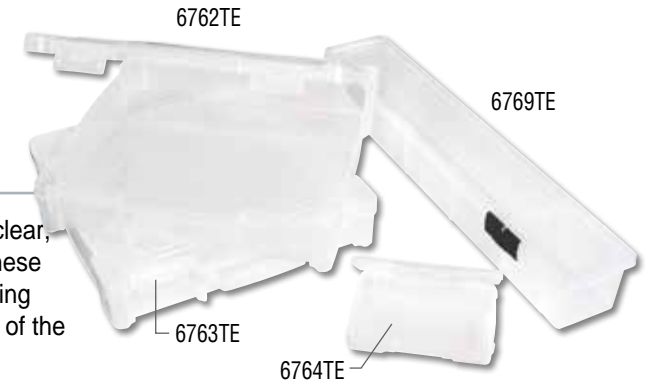

The Aegis Line

New Flambeau® Blow Mold Line! Rugged design with thick double walls, snap shut latches, locking points for extra security, steel pin hinge construction and integral handle for easy carry. **Page 70**



Mini and Small Gear Boxes

New Gear box sizes keep contents dry and protected. Perfect for storing small parts and keeps everything organized at your fingertips. **Page 89**





Distinctive Packaging For Quality Brands And Products™

Zerust® Bags

New Zerust® Line. Prevent rust on your valuable firearms for up to 5 years! **Page 100**

9" x 12" Pistol Bag: 412502A



10" x 54" Rifle Bag: 412502A

Tactical Series

2 Additional sizes to the Tactical line.

Small Tactical: Store more in one! Deep 6" base for extra storage, 4 pad lock holes, 2 tough snap-fit latches, an integral off-set handle for easier transport and 2 layers of foam in the base.

Medium Tactical: Distinctive 32" length featuring 5" depth, optional interchangeable divider compartments, 4 tough snap-fit latches and 4 pad lock holes for greater security.

Page 102



6791DDC



6505PDW

Linesman Case

Distinctive 42" length and 6" depth, this case is designed for multiple storage applications featuring tough ABS latches, steel pin hinge construction, four locking points and conveniently stacks for optimum storage. Also stocked with an 8 pistol foamset! **Page 103**



7450AP

7450BG

Waterproof Satchels

Protects contents from water and moisture with a 360 degree seal and features 2 locking points, a rubber over molded handle for easy carry, a recessed lid for extra work space, rust proof hinge and a durable polycarbonate lid with ribbing design providing extra strength for crush resistance. **Page 104**



4000WPOC

3000WPOC

The HD Case Series

New waterproof and airline ready cases with durable snap-shut latches, metal locking points and thick ribbed walls for high impact durability. These waterproof cases offer an extremely competitive choice for demanding applications. **Page 105**



4213AW

5213AW

1109AW

1410AW



A-Series Boxes

Styrene

The original Flambeau styrene box. The **A-Series** has a distinct stout look with very square corners and true 90° walls. Still a very popular pick with customers from many industries.

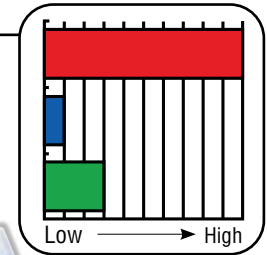

- Clarity*
- Impact Resistance
- Chemical Resistance



Compartment Boxes

SIZES

4-1/4" dia. x 3/4"
(10.80 dia. x 1.91 cm)

through 6-3/4" x 3-3/16" x 1-3/16"
through (17.15 x 8.10 x 3.02 cm)

BOX MATERIAL KEY

TP = Translucent Polypropylene
YP = Yellow Polypropylene
WP = White Polypropylene

TCP = Transparent Cellulose Propionate
SBMM = Styrene-Butadiene Methyl Methacrylate
SBC = Styrene-Butadiene Copolymer

SP = Taupe Polypropylene
OP = Orange Polypropylene

SYMBOL KEY

F = Blue Diamond
S = Special Order

BOX DIAGRAM	MODEL NUMBER	STOCK NUMBER	FAMILY	BOX MATERIAL	DIMENSIONS (INSIDE: L X W X D)	PACKED
 1 Compartment	A01 S	6685CC	A-Series	Styrene	4-1/4" dia. x 3/4" (10.80 dia. x 1.91 cm)	80/ctn
 1 Compartment	A226	6644CB	A-Series	Styrene	4-3/8" x 2-5/8" x 1.0" (11.11 x 6.67 x 2.54 cm)	36/ctn
 8 Compartments (L x W): A = 1.0" x 1-1/4" (2.54 x 3.18 cm)	A228 F	6646CB	A-Series	Styrene	4-3/8" x 2-5/8" x 1.0" (11.11 x 6.67 x 2.54 cm)	36/ctn

BOX DIAGRAM	MODEL NUMBER	STOCK NUMBER	FAMILY	BOX MATERIAL	DIMENSIONS (INSIDE: L X W X D)	PACKED
 4 Compartments (L x W): A= 2-3/16" x 1-5/16" (5.56 x 3.33 cm)	A221	6642CB	A-Series	Styrene	4-3/8" x 2-5/8" x 1.0" (11.11 x 6.67 x 2.54 cm)	36/ctn
 6 Compartments (L x W): A= 1-3/8" x 1-1/4" (3.49 x 3.18 cm)	A220	6640CB	A-Series	Styrene	4-3/8" x 2-5/8" x 1.0" (11.11 x 6.67 x 2.54 cm)	36/ctn
 1 Compartment	A101	6600CB	A-Series	Styrene	5-1/8" x 3-9/16" x 1-1/2" (13.02 x 9.05 x 3.81 cm)	36/ctn
 4 Compartments (L x W): A= 2-3/4" x 1-7/16" (6.99 x 3.65 cm)	A154	6602CB	A-Series	Styrene	5-5/8" x 2-15/16" x 1-1/8" (14.29 x 7.46 x 2.86 cm)	36/ctn
 5 Compartments (L x W): A= 1.0" x 2-7/8" (2.54 x 7.30 cm)	A155	6604CB	A-Series	Styrene	5-5/8" x 2-15/16" x 1-1/8" (14.29 x 7.46 x 2.86 cm)	36/ctn
 1 Compartment, Box Has Lift-Off Lid (Non-Hinged)	A250	6648CB	A-Series	Styrene	5-7/8" x 3-3/4" x 1-5/8" (14.92 x 9.53 x 4.13 cm)	36/ctn
 10 Compartments (L x W): A= 1-1/2" x 1-5/8" (3.81 x 4.13 cm), B= 1-7/16" x 1-5/8" (3.65 x 4.13 cm), C= 1-5/16" x 1-5/8" (3.33 x 4.13 cm), D= 1-1/4" x 1-5/8" (3.18 x 4.13 cm), E= 1-1/8" x 1-5/8" (2.86 x 4.13 cm)	A213	6621CM	A-Series	Styrene	6-3/4" x 3-3/16" x 1-3/16" (17.15 x 8.10 x 3.02 cm)	36/ctn
 2 Compartments (L x W): A= 3-5/16" x 3-1/4" (8.41 x 8.26 cm)	A214	6628CB	A-Series	Styrene	6-3/4" x 3-3/16" x 1-3/16" (17.15 x 8.10 x 3.02 cm)	36/ctn

* Adding color to the resins effects the clarity of the finished product



For Customer Service Inquiries Call: 1(800) 344-5716





SIZES 6-3/4" x 3-3/16" x 1-3/16" through 8.0" x 4.0" x 1-3/16"
 (17.15 x 8.10 x 3.02 cm) through (20.32 x 10.16 x 3.02 cm)

BOX MATERIAL KEY

TP = Translucent Polypropylene **TCP** = Transparent Cellulose Propionate **SP** = Taupe Polypropylene
YP = Yellow Polypropylene **SBMM** = Styrene-Butadiene Methyl Methacrylate **OP** = Orange Polypropylene
WP = White Polypropylene **SBC** = Styrene-Butadiene Copolymer

SYMBOL KEY

 = Blue Diamond
 = Special Order

BOX DIAGRAM	MODEL NUMBER	STOCK NUMBER	FAMILY	BOX MATERIAL	DIMENSIONS (INSIDE: L X W X D)	PACKED
 5 Compartments (L x W): A= 1-5/16" x 3-3/16" (3.33 x 8.10 cm)	A215	6630CB	A-Series	Styrene	6-3/4" x 3-3/16" x 1-3/16" (17.15 x 8.10 x 3.02 cm)	36/ctn
 9 Compartments (L x W): A= 1-5/16" x 1-9/16" (3.33 x 3.97 cm), B= 1-1/8" x 3-3/16" (2.86 x 8.10 cm)	A210	6622CB	A-Series	Styrene	6-3/4" x 3-3/16" x 1-3/16" (17.15 x 8.10 x 3.02 cm)	36/ctn
 12 Compartments (L x W): A= 1-7/16" x 1-1/16" (3.65 x 2.70 cm)	A219	6636CB	A-Series	Styrene	6-3/4" x 3-3/16" x 1-3/16" (17.15 x 8.10 x 3.02 cm)	36/ctn
 7 Compartments (L x W): A= 1-5/16" x 1-5/8" (3.33 x 4.13 cm), B= 4.0" x 1-1/16" (10.16 x 2.70 cm)	A217	6634CB	A-Series	Styrene	6-3/4" x 3-3/16" x 1-3/16" (17.15 x 8.10 x 3.02 cm)	36/ctn
 6 Compartments (L x W): A= 1-1/16" x 3-3/16" (2.70 x 8.10 cm)	A211 	6624CB	A-Series	Styrene	6-3/4" x 3-3/16" x 1-3/16" (17.15 x 8.10 x 3.02 cm)	36/ctn
 1 Compartment	A216 	6632CB	A-Series	Styrene	6-3/4" x 3-3/16" x 1-3/16" (17.15 x 8.10 x 3.02 cm)	36/ctn
 5 Compartments (L x W): A= 2-1/2" x 1-5/8" (6.35 x 4.13 cm), B= 1-5/8" x 3-1/4" (4.13 x 8.26 cm)	A212	6626CB	A-Series	Styrene	6-3/4" x 3-3/16" x 1-3/16" (17.15 x 8.10 x 3.02 cm)	36/ctn

BOX DIAGRAM	MODEL NUMBER	STOCK NUMBER	FAMILY	BOX MATERIAL	DIMENSIONS (INSIDE: L X W X D)	PACKED
 1 Compartment	A701	6670CB	A-Series	Styrene	6-7/8" x 2-1/16" x 1.0" (17.46 x 5.24 x 2.54 cm)	36/ctn
 1 Compartment	A401	6650CB	A-Series	Styrene	7-1/8" x 5-1/8" x 1-9/16" (18.10 x 13.02 x 3.97 cm)	36/ctn
 12 Compartments (L x W): A = 2-5/8" x 1-5/16" (6.67 x 3.33 cm), B = 1-5/16" x 1-1/4" (3.33 x 3.18 cm), C = 2-5/8" x 2-11/16" (6.67 x 6.83 cm)	A204	6614CB	A-Series	Styrene	8.0" x 4.0" x 1-3/16" (20.32 x 10.16 x 3.02 cm)	24/ctn
 1 Compartment	A206	6616CB	A-Series	Styrene	8.0" x 4.0" x 1-3/16" (20.32 x 10.16 x 3.02 cm)	24/ctn
 9 Compartments (L x W): A = 2-5/8" x 1-5/16" (6.67 x 3.33 cm), B = 1-1/4" x 1-5/16" (3.18 x 3.33 cm), C = 4.0" x 4.0" (10.16 x 10.16 cm)	A209	6620CB	A-Series	Styrene	8.0" x 4.0" x 1-3/16" (20.32 x 10.16 x 3.02 cm)	24/ctn
 18 Compartments (L x W): A = 1-1/4" x 1-1/4" (3.18 x 3.18 cm)	A200 	6608CB	A-Series	Styrene	8.0" x 4.0" x 1-3/16" (20.32 x 10.16 x 3.02 cm)	24/ctn
 12 Compartments (L x W): A = 1-1/4" x 1-15/16" (3.18 x 4.92 cm)	A208 	6618CB	A-Series	Styrene	8.0" x 4.0" x 1-3/16" (20.32 x 10.16 x 3.02 cm)	24/ctn
 12 Compartments (L x W): A = 1-5/16" x 1-5/16" (3.33 x 3.33 cm), B = 1-5/16" x 4.0" (3.33 x 10.16 cm), C = 1-5/16" x 2.0" (3.33 x 5.08 cm)	A201	6610CB	A-Series	Styrene	8.0" x 4.0" x 1-3/16" (20.32 x 10.16 x 3.02 cm)	24/ctn

* Adding color to the resins effects the clarity of the finished product



For Customer Service Inquiries Call: 1(800) 344-5716





SIZES 8.0" x 4.0" x 1-3/16" through 10-1/2" x 6-3/16" x 2-1/4"
 (20.32 x 10.16 x 3.02 cm) through (26.67 x 15.72 x 5.72 cm)

BOX MATERIAL KEY

SYMBOL KEY

TP = Translucent Polypropylene **TCP** = Transparent Cellulose Propionate **SP** = Taupe Polypropylene
YP = Yellow Polypropylene **SBMM** = Styrene-Butadiene Methyl Methacrylate **OP** = Orange Polypropylene
WP = White Polypropylene **SBC** = Styrene-Butadiene Copolymer

 = Blue Diamond
 = Special Order

BOX DIAGRAM	MODEL NUMBER	STOCK NUMBER	FAMILY	BOX MATERIAL	DIMENSIONS (INSIDE: L X W X D)	PACKED
 6 Compartments (L x W): A = 1-1/4" x 4.0" (3.18 x 10.16 cm)	A203	6612CB	A-Series	Styrene	8.0" x 4.0" x 1-3/16" (20.32 x 10.16 x 3.02 cm)	24/ctn
 36 Compartments (L x W): A = 1-9/16" x 1-1/16" (3.97 x 2.70 cm)	A166-36	6606CB	A-Series	Styrene	9-5/8" x 6-9/16" x 1-1/2" (24.45 x 16.69 x 3.81 cm)	12/ctn
 13 Compartments (L x W): A = 10-3/8" x 2-5/8" (26.35 x 6.67 cm), B = 1-11/16" x 1-5/16" (4.29 x 3.33 cm), C = 1-11/16" x 2.0" (4.29 x 5.08 cm)	A623 Ⓢ	6668CB	A-Series	Styrene	10-1/2" x 6-3/16" x 1-9/16" (26.67 x 15.72 x 3.97 cm)	24/ctn
 12 Compartments (L x W): A = 1-11/16" x 2.0" (4.29 x 5.08 cm), B = 1-11/16" x 4-1/8" (4.29 x 10.48 cm)	A612 Ⓢ	6662CB	A-Series	Styrene	10-1/2" x 6-3/16" x 1-9/16" (26.67 x 15.72 x 3.97 cm)	24/ctn
 12 Compartments (L x W): A = 1-11/16" x 3-1/16" (4.29 x 7.78 cm)	A602	6654CB	A-Series	Styrene	10-1/2" x 6-3/16" x 1-9/16" (26.67 x 15.72 x 3.97 cm)	24/ctn
 6 Compartments (L x W): A = 1-11/16" x 6-1/4" (4.29 x 15.88 cm)	A606	6658CB	A-Series	Styrene	10-1/2" x 6-3/16" x 1-9/16" (26.67 x 15.72 x 3.97 cm)	24/ctn
 13 Compartments (L x W): A = 1-11/16" x 2.0" (4.29 x 5.08 cm), B = 1-11/16" x 4-1/16" (4.29 x 10.32 cm), C = 3-1/2" x 4-1/16" (8.89 x 10.32 cm)	A613	6664CB	A-Series	Styrene	10-1/2" x 6-3/16" x 1-9/16" (26.67 x 15.72 x 3.97 cm)	24/ctn

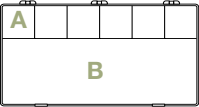
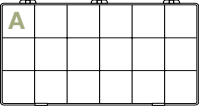
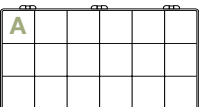
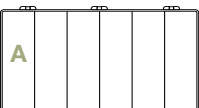
BOX DIAGRAM	MODEL NUMBER	STOCK NUMBER	FAMILY	BOX MATERIAL	DIMENSIONS (INSIDE: L X W X D)	PACKED
 <p>7 Compartments (L x W): A= 1-11/16" x 2.0" (4.29 x 5.08 cm), B= 10-1/2" x 4-1/16" (26.67 x 10.32 cm)</p>	A607 ®	6660CB	A-Series	Styrene	10-1/2" x 6-3/16" x 1-9/16" (26.67 x 15.72 x 3.97 cm)	24/ctn
 <p>1 Compartment</p>	A601	6652DB	A-Series	Styrene	10-1/2" x 6-3/16" x 1-9/16" (26.67 x 15.72 x 3.97 cm)	24/ctn
 <p>18 Compartments (L x W): A= 1-3/4" x 2-1/16" (4.45 x 5.24 cm)</p>	A618	6666CB	A-Series	Styrene	10-1/2" x 6-3/16" x 1-9/16" (26.67 x 15.72 x 3.97 cm)	24/ctn
 <p>3 Compartments (L x W): A= 10-1/2" x 2-1/16" (26.67 x 5.24 cm)</p>	A603 ®	6656CB	A-Series	Styrene	10-1/2" x 6-3/16" x 1-9/16" (26.67 x 15.72 x 3.97 cm)	24/ctn
 <p>12 Compartments (L x W): A= 1-11/16" x 2.0" (4.29 x 5.08 cm), B= 1-11/16" x 4-1/8" (4.29 x 10.48 cm)</p>	A612D ®	6662DB	A-Series	Styrene	10-1/2" x 6-3/16" x 2-1/4" (26.67 x 15.72 x 5.72 cm)	24/ctn
 <p>18 Compartments (L x W): A= 1-3/4" x 2-1/16" (4.45 x 5.24 cm)</p>	A618D ®	6666DB	A-Series	Styrene	10-1/2" x 6-3/16" x 2-1/4" (26.67 x 15.72 x 5.72 cm)	24/ctn
 <p>1 Compartment</p>	A601D ®	6652DB	A-Series	Styrene	10-1/2" x 6-3/16" x 2-1/4" (26.67 x 15.72 x 5.72 cm)	24/ctn
 <p>6 Compartments (L x W): A= 1-11/16" x 6-1/4" (4.29 x 15.88 cm)</p>	A606D ®	6658DB	A-Series	Styrene	10-1/2" x 6-3/16" x 2-1/4" (26.67 x 15.72 x 5.72 cm)	24/ctn

* Adding color to the resins effects the clarity of the finished product



For Customer Service Inquiries Call: 1(800) 344-5716











SIZES 10-9/16" x 8-1/4" x 1-9/16" through 12-3/4" x 8-1/2" x 2-1/8"
 (26.83 x 20.96 x 3.97 cm) through (32.39 x 21.59 x 5.40 cm)

BOX MATERIAL KEY

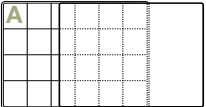

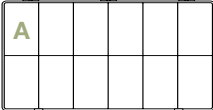
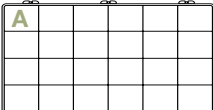
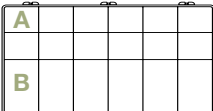







SYMBOL KEY

TP = Translucent Polypropylene **TCP** = Transparent Cellulose Propionate **SP** = Taupe Polypropylene
YP = Yellow Polypropylene **SBMM** = Styrene-Butadiene Methyl Methacrylate **OP** = Orange Polypropylene
WP = White Polypropylene **SBC** = Styrene-Butadiene Copolymer

 = Blue Diamond
 = Special Order

BOX DIAGRAM	MODEL NUMBER	STOCK NUMBER	FAMILY	BOX MATERIAL	DIMENSIONS (INSIDE: L X W X D)	PACKED
	A924-2	6684CB	A-Series	Styrene	10-9/16" x 8-1/4" x 1-9/16" (26.83 x 20.96 x 3.97 cm)	10/ctn
<i>24 Compartments (L x W): A= 1-11/16" x 2.0" (4.29 x 5.08 cm), Box has Sliding Lid (Non-Hinged)</i>						
	A801	6672CB	A-Series	Styrene	12-3/4" x 8-1/2" x 2-1/8" (32.39 x 21.59 x 5.40 cm)	12/ctn
<i>1 Compartment</i>						
	A812	6676CB	A-Series	Styrene	12-3/4" x 8-1/2" x 2-1/8" (32.39 x 21.59 x 5.40 cm)	12/ctn
<i>12 Compartments (L x W): A= 2-1/16" x 4-3/16" (5.24 x 12.22 cm)</i>						
	A824	6680CB	A-Series	Styrene	12-3/4" x 8-1/2" x 2-1/8" (32.39 x 21.59 x 5.40 cm)	12/ctn
<i>24 Compartments (L x W): A= 2-1/16" x 2-1/16" (5.24 x 5.24 cm)</i>						
	A818 	6678CB	A-Series	Styrene	12-3/4" x 8-1/2" x 2-1/8" (32.39 x 21.59 x 5.40 cm)	12/ctn
<i>18 Compartments (L x W): A= 2-1/16" x 2-1/16" (5.24 x 5.24 cm), B= 2-1/16" x 4-3/16" (5.24 x 12.22 cm)</i>						
	A806 	6674CB	A-Series	Styrene	12-3/4" x 8-1/2" x 2-1/8" (32.39 x 21.59 x 5.40 cm)	12/ctn
<i>6 Compartments (L x W): A= 2-1/16" x 8-1/2" (5.24 x 21.59 cm)</i>						

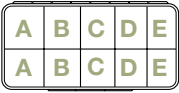
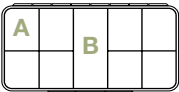
* Adding color to the resins effects the clarity of the finished product

BOX DIAGRAM	MODEL NUMBER	STOCK NUMBER	FAMILY	BOX MATERIAL	DIMENSIONS (INSIDE: L X W X D)	PACKED
 1 Compartment	A316-SL 	6641CB	A-Series	Styrene	4.0" x 3-2/5" x 1/2" (10.10 x 8.55 x 1.33 cm)	36/ctn
 6 Compartments (L x W): A = 1-1/3" x 1-2/3" (3.30 x 4.21 cm)	A311-SL 	6643CB	A-Series	Styrene	4.0" x 3-2/5" x 1/2" (10.10 x 8.55 x 1.33 cm)	36/ctn
 10 Compartments (L x W): A = 3/4" x 1-2/3" (1.93 x 4.21 cm)	A313-SL 	6645CB	A-Series	Styrene	4.0" x 3-2/5" x 1/2" (10.10 x 8.55 x 1.33 cm)	36/ctn
 1 Compartment	A216-SL 	6632CS	A-Series	Styrene	6-3/4" x 3-3/16" x 1/2" (17.15 x 8.10 x 1.27 cm)	36/ctn
 10 Compartments (L x W): A = 1-1/2" x 1-5/8" (3.81 x 4.13 cm), B = 1-7/16" x 1-5/8" (3.65 x 4.13 cm), C = 1-5/16" x 1-5/8" (3.33 x 4.13 cm), D = 1-1/4" x 1-5/8" (3.18 x 4.13 cm), E = 1-1/8" x 1-5/8" (2.86 x 4.13 cm)	A213-SL	6627CS	A-Series	Styrene	6-3/4" x 3-3/16" x 1/2" (17.15 x 8.10 x 1.27 cm)	36/ctn
 9 Compartments (L x W): A = 1-1/8" x 1-5/8" (2.86 x 4.13 cm), B = 1-1/8" x 3-3/8" (2.86 x 8.57 cm)	A210-SL 	6622CS	A-Series	Styrene	6-3/4" x 3-3/16" x 1/2" (17.15 x 8.10 x 1.27 cm)	36/ctn

From crafts to electronics and more, these translucent clear containers offer easy access and are great for organized storage.

6641CB

6643CB

6645CB

A213-SL





Precision-Series Boxes

Styrene Butadiene Methyl Methacrylate

Molded from styrene butadiene methyl methacrylate, this box features transparent clarity and impact resistance. The Precision excels in wet applications with its rust-proof hinge.

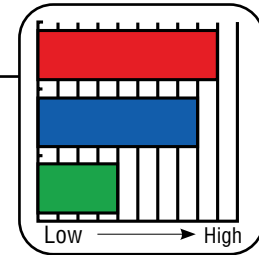

- Clarity*
- Impact Resistance
- Chemical Resistance



Compartment Boxes

SIZES 3-11/16" x 2-9/16" x 13/16" through 8-3/4" x 4-5/16" x 1-1/4"
(9.37 x 6.51 x 2.06 cm) through (22.23 x 10.95 x 3.18 cm)

BOX MATERIAL KEY

SYMBOL KEY

TP = Translucent Polypropylene
YP = Yellow Polypropylene
WP = White Polypropylene

TCP = Transparent Cellulose Propionate
SBMM = Styrene-Butadiene Methyl Methacrylate
SBC = Styrene-Butadiene Copolymer

SP = Taupe Polypropylene
OP = Orange Polypropylene

= Blue Diamond
 = Special Order

BOX DIAGRAM	MODEL NUMBER	STOCK NUMBER	FAMILY	BOX MATERIAL	DIMENSIONS (INSIDE: L X W X D)	PACKED
1 Compartment	2020-2	6240AA	Precision-Series	SBMM	3-11/16" x 2-9/16" x 13/16" (9.37 x 6.51 x 2.06 cm)	24/ctn
1 Compartment	3030-2	6730AA	Precision-Series	SBMM	5-5/8" x 3-5/8" x 1-1/8" (14.29 x 9.21 x 2.86 cm)	36/ctn
1 Compartment	4040-2	6740AA	Precision-Series	SBMM	8-3/4" x 4-5/16" x 1-1/4" (22.23 x 10.95 x 3.18 cm)	24/ctn



Highly recommended for individual seeking a tough compartmentalized case with a clear finish to store and protect valuable parts or everyday items.



For Customer Service Inquiries Call: 1(800) 344-5716





Diamondback™-Series Boxes

Styrene

With a slight architectural edge radius & rounded corners, this box is crystal clear like glass and is excellent for merchandising and general display of products. This box also has small stacking feet to keep displays neater and features an easy open hinge. US Patent D412,786

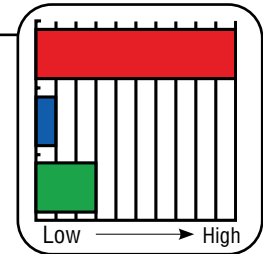

- Clarity*
- Impact Resistance
- Chemical Resistance



Compartment Boxes

SIZES 4-1/2" x 2-11/16" x 1.0" through 8-7/16" x 4-1/4" x 1-3/16"
(11.43 x 6.83 x 2.54 cm) through (21.43 x 10.80 x 3.02 cm)

BOX MATERIAL KEY

- TP** = Translucent Polypropylene
- YP** = Yellow Polypropylene
- WP** = White Polypropylene
- TCP** = Transparent Cellulose Propionate
- SBMM** = Styrene-Butadiene Methyl Methacrylate
- SBC** = Styrene-Butadiene Copolymer







- SP** = Taupe Polypropylene
- OP** = Orange Polypropylene

SYMBOL KEY

- = Blue Diamond
- = Special Order

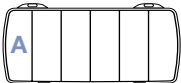
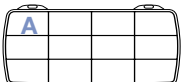
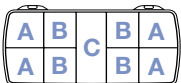
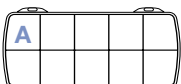
BOX DIAGRAM	MODEL NUMBER	STOCK NUMBER	FAMILY	BOX MATERIAL	DIMENSIONS (INSIDE: L X W X D)	PACKED
 4 Compartments (L x W): A= 2-3/16" x 1-5/16" (5.56 x 3.33 cm)	DB221	6742CD	Diamondback™-Series	Styrene	4-1/2" x 2-11/16" x 1.0" (11.43 x 6.83 x 2.54 cm)	24/ctn
 8 Compartments (L x W): A= 1-1/16" x 1-5/16" (2.70 x 3.33 cm)	DB228	6746CD	Diamondback™-Series	Styrene	4-1/2" x 2-11/16" x 1.0" (11.43 x 6.83 x 2.54 cm)	24/ctn
 6 Compartments (L x W): A= 1-5/16" x 1-7/16" (3.33 x 3.65 cm)	DB220	6740CD	Diamondback™-Series	Styrene	4-1/2" x 2-11/16" x 1.0" (11.43 x 6.83 x 2.54 cm)	24/ctn

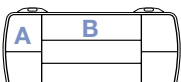
* Adding color to the resins effects the clarity of the finished product

BOX DIAGRAM	MODEL NUMBER	STOCK NUMBER	FAMILY	BOX MATERIAL	DIMENSIONS (INSIDE: L X W X D)	PACKED
 1 Compartment	DB226	6744CD	Diamondback™-Series	Styrene	4-1/2" x 2-11/16" x 1.0" (11.43 x 6.83 x 2.54 cm)	24/ctn
 1 Compartment	DB216	6732CD	Diamondback™-Series	Styrene	7.0" x 3-3/8" x 1-1/8" (17.78 x 8.57 x 2.86 cm)	25/ctn
 6 Compartments (L x W): A= 1-1/16" x 3-5/16" (2.70 x 8.41 cm)	DB211	6724CD	Diamondback™-Series	Styrene	7.0" x 3-3/8" x 1-1/8" (17.78 x 8.57 x 2.86 cm)	25/ctn
 12 Compartments (L x W): A= 1-3/4" x 1-1/16" (4.45 x 2.70 cm)	DB219	6736CD	Diamondback™-Series	Styrene	7.0" x 3-3/8" x 1-1/8" (17.78 x 8.57 x 2.86 cm)	25/ctn
 9 Compartments (L x W): A= 1-3/8" x 1-5/8" (3.49 x 4.13 cm), B= 1-5/16" x 1-5/8" (3.33 x 4.13 cm), C= 1-5/16" x 3-5/16" (3.33 x 8.41 cm)	DB210	6722CD	Diamondback™-Series	Styrene	7.0" x 3-3/8" x 1-1/8" (17.78 x 8.57 x 2.86 cm)	25/ctn
 10 Compartments (L x W): A= 1-5/16" x 1-5/8" (3.33 x 4.13 cm)	DB213 	6721CD	Diamondback™-Series	Styrene	7.0" x 3-3/8" x 1-1/8" (17.78 x 8.57 x 2.86 cm)	25/ctn
 7 Compartments (L x W): A= 1-5/16" x 1-5/8" (3.33 x 4.13 cm), B= 4-1/8" x 1-1/8" (10.48 x 2.86 cm)	DB217	6734CD	Diamondback™-Series	Styrene	7.0" x 3-3/8" x 1-1/8" (17.78 x 8.57 x 2.86 cm)	25/ctn
 12 Compartments (L x W): A= 1-5/16" x 1-5/16" (3.33 x 3.33 cm), B= 1-5/16" x 4-1/4" (3.33 x 10.80 cm), C= 1-5/16" x 2-1/16" (3.33 x 5.24 cm)	DB201	6710CD	Diamondback™-Series	Styrene	8-7/16" x 4-1/4" x 1-3/16" (21.43 x 10.80 x 3.02 cm)	24/ctn

* Adding color to the resins effects the clarity of the finished product



For Customer Service Inquiries Call: 1(800) 344-5716





SIZES 8-7/16" x 4-1/4" x 1-3/16" through 11.0" x 6-3/8" x 1-9/16"
 (21.43 x 10.80 x 3.02 cm) through (27.94 x 16.19 x 3.97 cm)







BOX MATERIAL KEY

TP = Translucent Polypropylene **TCP** = Transparent Cellulose Propionate **SP** = Taupe Polypropylene
YP = Yellow Polypropylene **SBMM** = Styrene-Butadiene Methyl Methacrylate **OP** = Orange Polypropylene
WP = White Polypropylene **SBC** = Styrene-Butadiene Copolymer

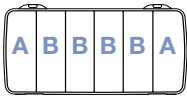
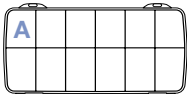
SYMBOL KEY

 = Blue Diamond
 = Special Order

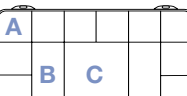
Compt Diamondback™ - Series

BOX DIAGRAM	MODEL NUMBER	STOCK NUMBER	FAMILY	BOX MATERIAL	DIMENSIONS (INSIDE: L X W X D)	PACKED
 6 Compartments (L x W): A= 1-3/8" x 4-1/4" (3.49 x 10.80 cm), B= 1-5/16" x 4-1/4" (3.33 x 10.80 cm)	DB203	6712CD	Diamondback™-Series	Styrene	8-7/16" x 4-1/4" x 1-3/16" (21.43 x 10.80 x 3.02 cm)	24/ctn
 12 Compartments (L x W): A= 1-3/8" x 2-1/16" (3.49 x 5.24 cm)	DB208 	6718CD	Diamondback™-Series	Styrene	8-7/16" x 4-1/4" x 1-3/16" (21.43 x 10.80 x 3.02 cm)	24/ctn
 18 Compartments (L x W): A= 1-3/8" x 1-3/8" (3.49 x 3.49 cm)	DB200 	6708CD	Diamondback™-Series	Styrene	8-7/16" x 4-1/4" x 1-3/16" (21.43 x 10.80 x 3.02 cm)	24/ctn
 1 Compartment	DB206 	6716CD	Diamondback™-Series	Styrene	8-7/16" x 4-1/4" x 1-3/16" (21.43 x 10.80 x 3.02 cm)	24/ctn
 12 Compartments (L x W): A= 3.0" x 1-3/8" (7.62 x 3.49 cm), B= 1-3/8" x 1-3/8" (3.49 x 3.49 cm), C= 3.0" x 2-3/4" (7.62 x 6.99 cm)	DB204	6714CD	Diamondback™-Series	Styrene	8-7/16" x 4-1/4" x 1-3/16" (21.43 x 10.80 x 3.02 cm)	24/ctn
 6 Compartments (L x W): A= 1-3/4" x 6-3/8" (4.45 x 16.19 cm)	DB606	6758CD	Diamondback™-Series	Styrene	11.0" x 6-3/8" x 1-9/16" (27.94 x 16.19 x 3.97 cm)	12/ctn
 13 Compartments (L x W): A= 1-7/8" x 2-1/16" (4.76 x 5.24 cm), B= 1-3/4" x 4-1/8" (4.45 x 10.48 cm), C= 3-9/16" x 4-1/8" (9.05 x 10.48 cm)	DB613 	6764CD	Diamondback™-Series	Styrene	11.0" x 6-3/8" x 1-9/16" (27.94 x 16.19 x 3.97 cm)	12/ctn

* Adding color to the resins effects the clarity of the finished product

BOX DIAGRAM	MODEL NUMBER	STOCK NUMBER	FAMILY	BOX MATERIAL	DIMENSIONS (INSIDE: L X W X D)	PACKED
-------------	--------------	--------------	--------	--------------	--------------------------------	--------



1 Compartment

DB601 ®

6752CD

Diamondback™-Series

Styrene

11.0" x 6-3/8" x 1-9/16"
(27.94 x 16.19 x 3.97 cm)

12/ctn

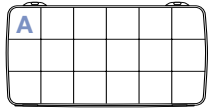

18 Compartments (L x W): A= 1-3/4" x 2-1/16" (4.45 x 5.24 cm)

DB618

6766CD

Diamondback™-Series

Styrene

11.0" x 6-3/8" x 1-9/16"
(27.94 x 16.19 x 3.97 cm)

12/ctn

* Adding color to the resins effects the clarity of the finished product



Quickly view the contents from the outside with this high clarity compartment box. This series is also FDA approved.



For Customer Service Inquiries Call: 1(800) 344-5716



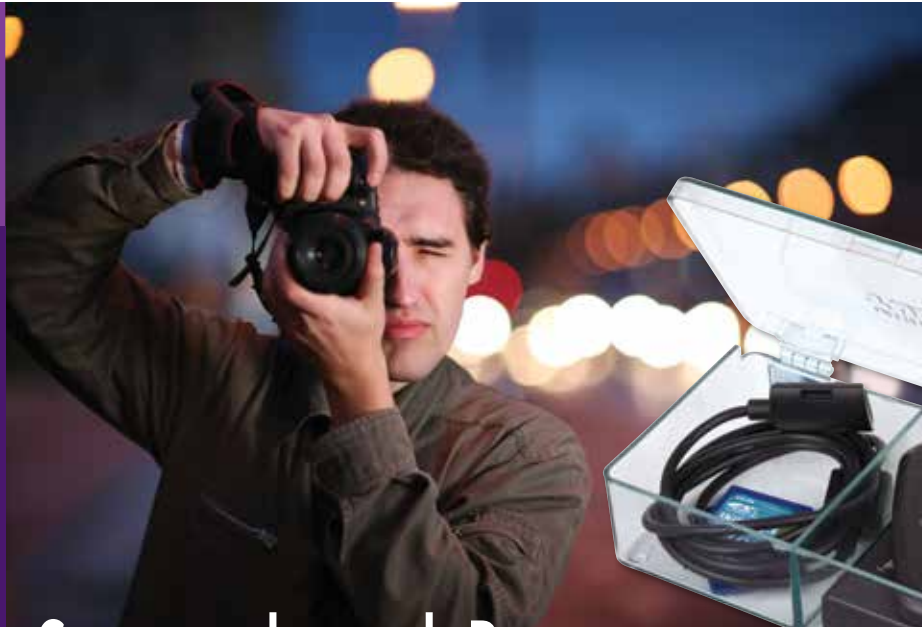

Mighty-Tuff™ -Series Boxes

Cellulose Propionate

Just as the name implies, the Mighty-Tuff is tough! This transparent cellulose propionate material excels in industrial and institutional environments. With a double metal hinge you can be sure that this box will take almost any punishment you can give it.

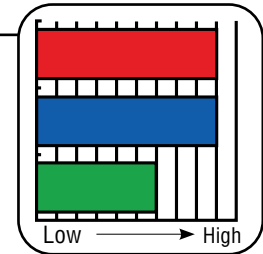

■ Clarity*
■ Impact Resistance
■ Chemical Resistance

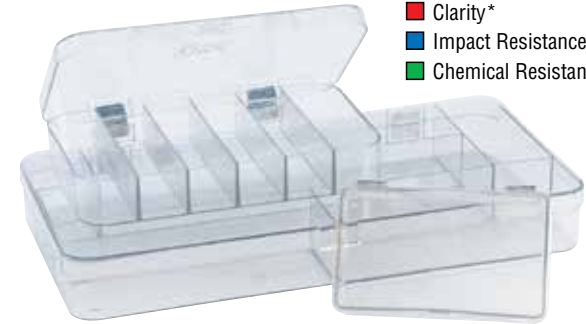

Compartment Boxes

SIZES 4-5/16" x 2-5/8" x 1-1/16" through 11.15/16" x 5-15/16" x 1-7/16"
 (10.95 x 6.67 x 2.70 cm) through (30.32 x 15.08 x 3.65 cm)



BOX MATERIAL KEY



TP = Translucent Polypropylene
YP = Yellow Polypropylene
WP = White Polypropylene

TCP = Transparent Cellulose Propionate
SBMM = Styrene-Butadiene Methyl Methacrylate
SBC = Styrene-Butadiene Copolymer



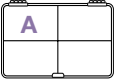

SP = Taupe Polypropylene
OP = Orange Polypropylene

SYMBOL KEY

 = Blue Diamond
 = Special Order

BOX DIAGRAM	MODEL NUMBER	STOCK NUMBER	FAMILY	BOX MATERIAL	DIMENSIONS (INSIDE: L X W X D)	PACKED
 1 Compartment	5200CL	6230MT	Mighty-Tuff™ -Series	TCP	4-5/16" x 2-5/8" x 1-1/16" (10.95 x 6.67 x 2.70 cm)	12/ctn
 2 Compartments (L x W): A = 2-1/8" x 2-5/8" (5.40 x 6.67 cm)	5202CL	6232MT	Mighty-Tuff™ -Series	TCP	4-5/16" x 2-5/8" x 1-1/16" (10.95 x 6.67 x 2.70 cm)	12/ctn
 4 Compartments (L x W): A = 2-1/8" x 1-1/4" (5.40 x 3.18 cm)	5204CL	6234MT	Mighty-Tuff™ -Series	TCP	4-5/16" x 2-5/8" x 1-1/16" (10.95 x 6.67 x 2.70 cm)	12/ctn

* Adding color to the resins effects the clarity of the finished product

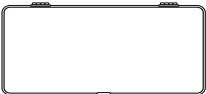
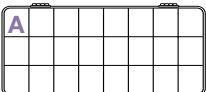
BOX DIAGRAM	MODEL NUMBER	STOCK NUMBER	FAMILY	BOX MATERIAL	DIMENSIONS (INSIDE: L X W X D)	PACKED
 6 Compartments (L x W): A= 1-3/8" x 1-5/16" (3.49 x 3.33 cm)	5206CL ®	6236MT	Mighty-Tuff™-Series	TCP	4-5/16" x 2-5/8" x 1-1/16" (10.95 x 6.67 x 2.70 cm)	12/ctn
 17 Compartments (L x W): A= 1-1/4" x 7/8" (3.18 x 2.22 cm), B= 1-3/16" x 4.0" (3.02 x 10.16 cm)	5126CL	6220MT	Mighty-Tuff™-Series	TCP	7.0" x 4.0" x 1-1/16" (17.78 x 10.16 x 2.70 cm)	12/ctn
 11 Compartments (L x W): A= 1-3/16" x 4.0" (3.02 x 10.16 cm), B= 1-1/4" x 2.0" (3.18 x 5.08 cm), C= 1-1/4" x 7/8" (3.18 x 2.22 cm)	5127CL	6222MT	Mighty-Tuff™-Series	TCP	7.0" x 4.0" x 1-1/16" (17.78 x 10.16 x 2.70 cm)	12/ctn
 6 Compartments (L x W): A= 1-3/16" x 4.0" (3.02 x 10.16 cm)	5128CL	6224MT	Mighty-Tuff™-Series	TCP	7.0" x 4.0" x 1-1/16" (17.78 x 10.16 x 2.70 cm)	12/ctn
 1 Compartment	5129-1	6789CH	Mighty-Tuff™-Series	TCP	11-15/16" x 5-15/16" x 1-7/16" (30.32 x 15.08 x 3.65 cm)	6/ctn
 24 Compartments (L x W): A= 1-7/16" x 1-7/8" (3.65 x 4.76 cm)	5129CL	6226MT	Mighty-Tuff™-Series	TCP	11-15/16" x 5-15/16" x 1-7/16" (30.32 x 15.08 x 3.65 cm)	6/ctn
 6 Compartments (L x W): A= 1-7/16" x 3-15/16" (3.65 x 10.00 cm), B= 8-7/8" x 1-7/8" (22.54 x 4.76 cm), C= 1-7/16" x 1-7/8" (3.65 x 4.76 cm), D= 10-3/8" x 1-7/8" (26.35 x 4.76 cm), E= 5-15/16" x 1-7/8" (15.08 x 4.76 cm)	5130CL	6228MT	Mighty-Tuff™-Series	TCP	11-15/16" x 5-15/16" x 1-7/16" (30.32 x 15.08 x 3.65 cm)	6/ctn

* Adding color to the resins effects the clarity of the finished product



For Customer Service Inquiries Call: 1(800) 344-5716





M-Series Boxes

Polypropylene

Extra heavy-duty construction makes the polypropylene M-Series boxes tough and durable. These workhorse boxes feature a heavy-duty, heat-sealed hinge and overlapping lid to inhibit dust. Impervious to most household chemicals, solvents, oil and gasoline, these boxes keep items safe and organized.

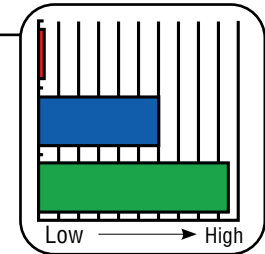

- Clarity*
- Impact Resistance
- Chemical Resistance



Compartment Boxes

SIZES 4-3/8" x 2-5/8" x 1.0" through 10-1/2" x 6-3/16" x 1-9/16"
(11.11 x 6.67 x 2.54 cm) through (26.67 x 15.72 x 3.97 cm)

BOX MATERIAL KEY

- TP** = Translucent Polypropylene
- YP** = Yellow Polypropylene
- WP** = White Polypropylene
- TCP** = Transparent Cellulose Propionate
- SBMM** = Styrene-Butadiene Methyl Methacrylate
- SBC** = Styrene-Butadiene Copolymer

SYMBOL KEY

- = Blue Diamond
- = Special Order

BOX DIAGRAM	MODEL NUMBER	STOCK NUMBER	FAMILY	BOX MATERIAL	DIMENSIONS (INSIDE: L X W X D)	PACKED
 4 Compartments (L x W): A= 2-3/16" x 1-5/16" (5.56 x 3.33 cm)	M221	6706TF	M-Series	YP	4-3/8" x 2-5/8" x 1.0" (11.11 x 6.67 x 2.54 cm)	36/ctn
 6 Compartments (L x W): A= 1-3/8" x 1-1/4" (3.49 x 3.18 cm)	M220	6704TF	M-Series	YP	4-3/8" x 2-5/8" x 1.0" (11.11 x 6.67 x 2.54 cm)	36/ctn
 5 Compartments (L x W): A= 1-5/16" x 3-3/16" (3.33 x 8.10 cm)	M215	6702TF	M-Series	YP	6-3/4" x 3-3/16" x 1-3/16" (17.15 x 8.10 x 3.02 cm)	36/ctn

BOX DIAGRAM	MODEL NUMBER	STOCK NUMBER	FAMILY	BOX MATERIAL	DIMENSIONS (INSIDE: L X W X D)	PACKED
	M210	6698TF	M-Series	YP	6-3/4" x 3-3/16" x 1-3/16" (17.15 x 8.10 x 3.02 cm)	36/ctn
9 Compartments (L x W): A = 1-5/16" x 1-9/16" (3.33 x 3.97 cm), B = 1-1/8" x 3-3/16" (2.86 x 8.10 cm)						
	M200 ®	6690TF	M-Series	YP	8.0" x 4.0" x 1-3/16" (20.32 x 10.16 x 3.02 cm)	24/ctn
18 Compartments (L x W): A = 1-1/4" x 1-1/4" (3.18 x 3.18 cm)						
	M208	6696TF	M-Series	YP	8.0" x 4.0" x 1-3/16" (20.32 x 10.16 x 3.02 cm)	24/ctn
12 Compartments (L x W): A = 1-1/4" x 1-15/16" (3.18 x 4.92 cm)						
	M201	6692TF	M-Series	YP	8.0" x 4.0" x 1-3/16" (20.32 x 10.16 x 3.02 cm)	24/ctn
12 Compartments (L x W): A = 1-5/16" x 1-5/16" (3.33 x 3.33 cm), B = 1-5/16" x 4.0" (3.33 x 10.16 cm), C = 1-5/16" x 2.06" (3.33 x 5.08 cm)						
	M203	6694TF	M-Series	YP	8.0" x 4.0" x 1-3/16" (20.32 x 10.16 x 3.02 cm)	24/ctn
6 Compartments (L x W): A = 1-1/4" x 4.0" (3.18 x 10.16 cm)						
	M616R ®	6713TF	M-Series	YP	10-1/2" x 6-3/16" x 1-9/16" (26.67 x 15.72 x 3.97 cm)	24/ctn
4 Compartments & 12 Removable Dividers (L x W): A = 10-3/8" x 1-1/2" (26.35 x 3.81 cm)						
	M623	6716TF	M-Series	YP	10-1/2" x 6-3/16" x 1-9/16" (26.67 x 15.72 x 3.97 cm)	24/ctn
13 Compartments (L x W): A = 10-3/8" x 2-5/8" (26.35 x 6.67 cm), B = 1-11/16" x 1-5/16" (4.29 x 3.33 cm), C = 1-11/16" x 2.0" (4.29 x 5.08 cm)						
	M612	6712TF	M-Series	YP	10-1/2" x 6-3/16" x 1-9/16" (26.67 x 15.72 x 3.97 cm)	24/ctn
12 Compartments (L x W): A = 1-11/16" x 2.0" (4.29 x 5.08 cm), B = 1-11/16" x 4-1/8" (4.29 x 10.48 cm)						

* Adding color to the resins effects the clarity of the finished product



For Customer Service Inquiries Call: 1(800) 344-5716



SIZES

10-1/2" x 6-3/16" x 1-9/16" through 12-3/4" x 8-1/2" x 2-1/8"
(26.67 x 15.72 x 3.97 cm) through (32.39 x 21.59 x 5.40 cm)



BOX MATERIAL KEY

TP = Translucent Polypropylene
YP = Yellow Polypropylene
WP = White Polypropylene

TCP = Transparent Cellulose Propionate
SBMM = Styrene-Butadiene Methyl Methacrylate
SBC = Styrene-Butadiene Copolymer

SP = Taupe Polypropylene
OP = Orange Polypropylene

SYMBOL KEY

 = Blue Diamond
 = Special Order

Compt M - Series

BOX DIAGRAM	MODEL NUMBER	STOCK NUMBER	FAMILY	BOX MATERIAL	DIMENSIONS (INSIDE: L X W X D)	PACKED
 12 Compartments (L x W): A = 1-11/16" x 3-1/16" (4.29 x 7.78 cm)	M602	6708TF	M-Series	YP	10-1/2" x 6-3/16" x 1-9/16" (26.67 x 15.72 x 3.97 cm)	24/ctn
 6 Compartments (L x W): A = 1-11/16" x 6-1/4" (4.29 x 15.88 cm)	M606	6710TF	M-Series	YP	10-1/2" x 6-3/16" x 1-9/16" (26.67 x 15.72 x 3.97 cm)	24/ctn
 18 Compartments (L x W): A = 1-3/4" x 2-1/16" (4.45 x 5.24 cm)	M618	6714TF	M-Series	YP	10-1/2" x 6-3/16" x 1-9/16" (26.67 x 15.72 x 3.97 cm)	24/ctn
 12 Compartments (L x W): A = 1-11/16" x 2.0" (4.29 x 5.08 cm), B = 1-11/16" x 4-1/8" (4.29 x 10.48 cm)	M612D 	6712DB	M-Series	YP	10-1/2" x 6-3/16" x 2-1/4" (26.67 x 15.72 x 5.72 cm)	24/ctn
 18 Compartments (L x W): A = 1-3/4" x 2-1/16" (4.45 x 5.24 cm)	M618D 	6714DB	M-Series	YP	10-1/2" x 6-3/16" x 2-1/4" (26.67 x 15.72 x 5.72 cm)	24/ctn
 6 Compartments (L x W): A = 1-11/16" x 6-1/4" (4.29 x 15.88 cm)	M606D 	6710DB	M-Series	YP	10-1/2" x 6-3/16" x 2-1/4" (26.67 x 15.72 x 5.72 cm)	24/ctn
 8 Compartments (L x W): A = 2-1/16" x 8-1/2" (5.24 x 21.59 cm), B = 2-1/16" x 4-1/8" (5.24 x 10.48 cm), C = 2-1/16" x 2.0" (5.24 x 5.08 cm)	M808 	6720TF	M-Series	YP	12-1/2" x 8-1/4" x 2-1/4" (31.75 x 20.96 x 5.72 cm)	12/ctn

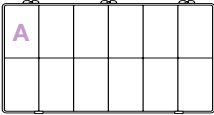
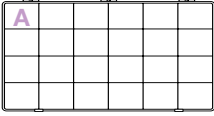
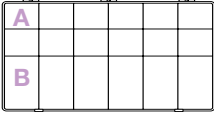
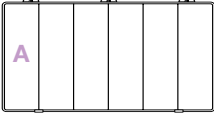
BOX DIAGRAM	MODEL NUMBER	STOCK NUMBER	FAMILY	BOX MATERIAL	DIMENSIONS (INSIDE: L X W X D)	PACKED
 <p>12 Compartments (L x W): A= 2-1/16" x 4-3/16" (5.24 x 12.22 cm)</p>	M812	6722TF	M-Series	YP	12-3/4" x 8-1/2" x 2-1/8" (32.39 x 21.59 x 5.40 cm)	12/ctn
 <p>24 Compartments (L x W): A= 2-1/16" x 2-1/16" (5.24 x 5.24 cm)</p>	M824	6726TF	M-Series	YP	12-3/4" x 8-1/2" x 2-1/8" (32.39 x 21.59 x 5.40 cm)	12/ctn
 <p>18 Compartments (L x W): A= 2-1/16" x 2-1/16" (5.24 x 5.24 cm), B= 2-1/16" x 4-3/16" (5.24 x 12.22 cm)</p>	M818	6724TF	M-Series	YP	12-3/4" x 8-1/2" x 2-1/8" (32.39 x 21.59 x 5.40 cm)	12/ctn
 <p>6 Compartments (L x W): A= 2-1/16" x 8-1/2" (5.24 x 21.59 cm)</p>	M806	6718TF	M-Series	YP	12-3/4" x 8-1/2" x 2-1/8" (32.39 x 21.59 x 5.40 cm)	12/ctn

* Adding color to the resins effects the clarity of the finished product



For Customer Service Inquiries Call: 1(800) 344-5716





V-Series Boxes

Polypropylene

With a living hinge (flex hinge) and dual positive snap lock latches these single compartment boxes are excellent for storing welding rods, wire & cable ties, even dental instruments! Boxes can be autoclaved.

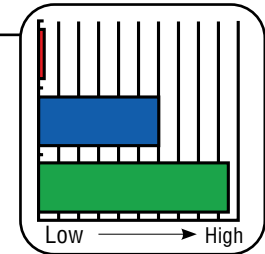

- Clarity*
- Impact Resistance
- Chemical Resistance



Compartment Boxes

SIZES



6-7/8" x 2-1/16" x 1.0" through 17.0" x 7-1/8" x 2.0"
 (17.46 x 5.24 x 2.54 cm) through (43.18 x 18.10 x 5.08 cm)

BOX MATERIAL KEY

- TP** = Translucent Polypropylene
- YP** = Yellow Polypropylene
- WP** = White Polypropylene
- TCP** = Transparent Cellulose Propionate
- SBMM** = Styrene-Butadiene Methyl Methacrylate
- SBC** = Styrene-Butadiene Copolymer

SYMBOL KEY

- = Blue Diamond
- = Special Order

BOX DIAGRAM	MODEL NUMBER	STOCK NUMBER	FAMILY	BOX MATERIAL	DIMENSIONS (INSIDE: L X W X D)	PACKED
 1 Compartment	V301	6142VB	V-Series	OP	6-7/8" x 2-1/16" x 1.0" (17.46 x 5.24 x 2.54 cm)	36/ctn
 1 Compartment	V301PT	6650VC	V-Series	SP	6-7/8" x 2-1/16" x 1.0" (17.46 x 5.24 x 2.54 cm)	36/ctn
 1 Compartment	V401	6152VB	V-Series	SP	8-1/8" x 4-1/8" x 1-3/16" (20.64 x 10.48 x 3.02 cm)	24/ctn

BOX DIAGRAM	MODEL NUMBER	STOCK NUMBER	FAMILY	BOX MATERIAL	DIMENSIONS (INSIDE: L X W X D)	PACKED
 2 Compartments (L x W): A= 8-1/4" x 1-1/4" (20.96 x 10.16 cm)	V402-2 ®	6655VA	V-Series	SP	8-1/8" x 4-1/8" x 1-3/16" (20.64 x 10.48 x 3.02 cm)	24/ctn
 1 Compartment	V401D-2 ⚡	6654DV	V-Series	SP	8-1/8" x 4-1/8" x 2-5/8" (20.64 x 10.48 x 6.67 cm)	24/ctn
 1 Compartment	V501 ⚡	6160VB	V-Series	SP	10.0" x 4-1/4" x 1-1/2" (25.40 x 10.80 x 3.81 cm)	24/ctn
 6 Compartments (L x W): A= 1-5/8" x 4-1/4" (4.13 x 10.80 cm)	V506-2 ®	6660VA	V-Series	SP	10.0" x 4-1/4" x 1-1/2" (25.40 x 10.80 x 3.81 cm)	24/ctn
 1 Compartment	V601 ⚡	6667VB	V-Series	SP	13-1/2" x 5-3/4" x 2.0" (34.29 x 14.61 x 5.08 cm)	12/ctn
 1 Compartment	V701	6172VB	V-Series	SP	17.0" x 7-1/8" x 2.0" (43.18 x 18.10 x 5.08 cm)	6/ctn

* Adding color to the resins effects the clarity of the finished product



From dental instruments to porcelain molds, the V-Series box can handle it all!



For Customer Service Inquiries Call: 1(800) 344-5716





Tuff Tainer®-Series Boxes

Polypropylene

The Tuff Tainer is made with polypropylene and features a detachable lid and movable dividers that allow you to configure your compartment space to your liking. The majority of these boxes include two positive locking latches and will resist most common chemicals, gasoline & oil.

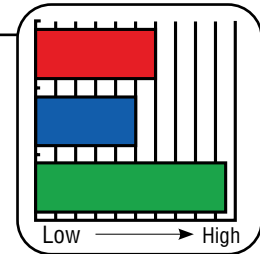

- Clarity*
- Impact Resistance
- Chemical Resistance



Mechanical latch found on T4007 & T5007 Tuff Tainers



Integral latch found on all Tuff Tainers except T4007 & T5007



Compartment Boxes

SIZES 4-5/16" x 2-5/8" x 1-1/8" through 13-11/16" x 8-3/16" x 1-3/4"
(10.95 x 6.67 x 2.86 cm) through (34.77 x 20.80 x 4.45 cm)

BOX MATERIAL KEY

- TP** = Translucent Polypropylene
- YP** = Yellow Polypropylene
- WP** = White Polypropylene
- TCP** = Transparent Cellulose Propionate
- SBMM** = Styrene-Butadiene Methyl Methacrylate
- SBC** = Styrene-Butadiene Copolymer

SYMBOL KEY

- = Blue Diamond
- = Special Order

BOX DIAGRAM	MODEL NUMBER	STOCK NUMBER	FAMILY	BOX MATERIAL	DIMENSIONS (INSIDE: L X W X D)	PACKED
	T1002	6709TE	Tuff Tainer®-Series	TP	4-5/16" x 2-5/8" x 1-1/8" (10.95 x 6.67 x 2.86 cm)	12/ctn
4 Compartments & 2 Removable Dividers (L x W): A = 3.0" x 1-1/4" (7.62 x 3.18 cm), B = 1-1/4" x 1-1/4" (10.16 x 10.16 cm)						
	T2003	6703TE	Tuff Tainer-Series	TP	6-11/16" x 3-5/16" x 1-5/16" (16.99 x 8.41 x 3.33 cm)	12/ctn
3 Compartments & 15 Removable Dividers (L x W): A = 6-11/16" x 1-1/16" (16.99 x 2.70 cm)						
	T3003	6707TE	Tuff Tainer-Series	TP	8-7/8" x 4-1/8" x 1-3/16" (22.54 x 10.48 x 3.02 cm)	12/ctn
3 Compartments & 15 Removable Dividers (L x W): A = 8-7/8" x 1-3/8" (22.54 x 3.49 cm)						

BOX DIAGRAM	MODEL NUMBER	STOCK NUMBER	FAMILY	BOX MATERIAL	DIMENSIONS (INSIDE: L X W X D)	PACKED
	T4004	6744TE	Tuff Tainer®-Series	TP	10-5/8" x 6-5/8" x 1-9/16" (26.99 x 16.83 x 3.97 cm)	6/ctn
4 Compartments & 12 Removable Dividers (L x W): A = 5.0" x 6-5/8" (12.70 x 16.38 cm), B = 1-3/4" x 6-5/8" (4.45 x 16.38 cm)						
	T4007E 	6746TE	Tuff Tainer-Series	TP	10-5/8" x 6-5/8" x 1-9/16" (26.99 x 16.83 x 3.97 cm)	6/ctn
6 Compartments, Integral Latches & 12 Removable Dividers (L x W): A = 1-11/16" x 6-1/4" (4.29 x 15.87 cm)						
	T4007 	6747TE	Tuff Tainer-Series	TP	10-5/8" x 6-5/8" x 1-9/16" (26.99 x 16.83 x 3.97 cm)	6/ctn
6 Compartments, Black Mechanical Latches & 12 Removable Dividers (L x W): A = 1-11/16" x 6-1/4" (4.29 x 15.87 cm)						
	T4007AT	6748TE	Tuff Tainer-Series	TP	10-5/8" x 6-5/8" x 1-9/16" (26.99 x 16.83 x 3.97 cm)	6/ctn
6 Compartments, Silver Mechanical Latches & 12 Removable Anti-Tarnish Dividers (L x W): A = 1-11/16" x 6-1/4" (4.29 x 15.87 cm)						
	T4008	6749TE	Tuff Tainer-Series	TP	10-5/8" x 6-5/8" x 1-9/16" (26.99 x 16.83 x 3.97 cm)	6/ctn
6 Compartments, Black Mechanical Latches & 12 Removable Dividers (L x W): A = 1-11/16" x 6-1/4" (4.29 x 15.87 cm)						
	T4000	6734TE	Tuff Tainer-Series	TP	10-5/8" x 6-5/8" x 1-9/16" (26.99 x 16.83 x 3.97 cm)	6/ctn
1 Compartment						
	T3011	6711TE	Tuff Tainer-Series	TP	12.0" x 4.0" x 1-1/16" (30.48 x 10.16 x 2.70 cm)	6/ctn
1 Compartment						
	T5003 	6753TE	Tuff Tainer-Series	TP	13-11/16" x 8-3/16" x 1-3/4" (34.77 x 20.80 x 4.45 cm)	6/ctn
3 Compartments & 12 Removable Dividers (L x W): A = 13-11/16" x 2-1/8" (34.77 x 3.40 cm), B = 13-11/16" x 4-1/8" (34.77 x 10.48 cm)						
	T5007 	6757TE	Tuff Tainer-Series	TP	13-11/16" x 8-3/16" x 1-3/4" (34.77 x 20.80 x 4.45 cm)	6/ctn
4 Compartments, Black Mechanical Latches & 20 Removable Dividers (L x W): A = 13-11/16" x 2.0" (34.77 x 5.08 cm), B = 13-11/16" x 1-11/16" (34.77 x 4.29 cm)						



For Customer Service Inquiries Call: 1(800) 344-5716





SIZES 13-11/16" x 8-3/16" x 1-3/4" through 15-1/4" x 8-7/8" x 3.0"
 (34.77 x 20.80 x 4.45 cm) through (38.74 x 22.54 x 7.62 cm)

BOX MATERIAL KEY

TP = Translucent Polypropylene **TCP** = Transparent Cellulose Propionate **SP** = Taupe Polypropylene
YP = Yellow Polypropylene **SBMM** = Styrene-Butadiene Methyl Methacrylate **OP** = Orange Polypropylene
WP = White Polypropylene **SBC** = Styrene-Butadiene Copolymer



SYMBOL KEY

 = Blue Diamond
 = Special Order

BOX DIAGRAM	MODEL NUMBER	STOCK NUMBER	FAMILY	BOX MATERIAL	DIMENSIONS (INSIDE: L X W X D)	PACKED
	T5008 	6768TE	Tuff Tainer®-Series	TP	13-11/16" x 8-3/16" x 1-3/4" (34.77 x 20.80 x 4.45 cm)	6/ctn
4 Compartments, Black Mechanical Latches & 20 Removable Dividers (L x W): A = 13-11/16" x 2.0" (34.77 x 5.08 cm), B = 13-11/16" x 1-11/16" (34.77 x 4.29 cm)						
	T5007AT	6758TE	Tuff Tainer-Series	TP	13-11/16" x 8-3/16" x 1-3/4" (34.77 x 20.80 x 4.45 cm)	6/ctn
4 Compartments, Silver Mechanical Latches & 15 Removable Anti-Tarnish Dividers (Ref. page 5) (L x W): A = 13-11/16" x 2.0" (34.77 x 5.08 cm), B = 13-11/16" x 1-11/16" (34.77 x 4.29 cm)						
	T5007E 	6756TE	Tuff Tainer-Series	TP	13-11/16" x 8-3/16" x 1-3/4" (34.77 x 20.80 x 4.45 cm)	6/ctn
4 Compartments, Integral Latches & 20 Removable Dividers (L x W): A = 13-11/16" x 2.0" (34.77 x 5.08 cm), B = 13-11/16" x 1-11/16" (34.77 x 4.29 cm)						
	T6004 	6760TE	Tuff Tainer-Series	TP	15-1/4" x 8-7/8" x 1-3/8" (38.74 x 22.54 x 3.49 cm)	6/ctn
6 Compartments & 28 Removable Dividers (L x W): A = 15-5/16" x 2.0" (38.89 x 5.08 cm), B = 3-1/4" x 2.0" (8.26 x 5.08 cm), C = 8-1/2" x 2.0" (21.59 x 5.08 cm)						
	T7003	6773TE	Tuff Tainer-Series	TP	15-1/4" x 8-7/8" x 3.0" (38.74 x 22.54 x 7.62 cm)	6/ctn
6 Compartments & 3 Removable Dividers (L x W): A = 15-1/4" x 4-1/2" (38.74 x 11.43 cm), B = 15-1/4" x 2-1/8" (38.74 x 5.40 cm), C = 3-3/4" x 2-1/8" (9.53 x 5.40 cm), D = 3-3/4" x 1-1/2" (9.53 x 3.81 cm)						
	T7004 	6774TE	Tuff Tainer-Series	TP	15-1/4" x 8-7/8" x 3.0" (38.74 x 22.54 x 7.62 cm)	6/ctn
7 Compartments & 9 Removable Dividers (L x W): A = 15-1/4" x 2-3/16" (38.74 x 5.56 cm), B = 3-3/4" x 2-1/8" (9.52 x 5.40 cm), C = 3-3/4" x 2-1/8" (9.52 x 5.40 cm)						
	T7000 	6770TE	Tuff Tainer-Series	TP	15-1/4" x 8-7/8" x 3.0" (38.74 x 22.54 x 7.62 cm)	6/ctn
1 Compartment						

Compt Tuff Tainer® - Series

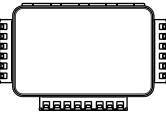
Compt Tuff Tainer Series: **WATERPROOF** Boxes **SIZES** 6-5/8" x 3-9/16" x 1.0" through 12-1/2" x 7-1/2" x 2-5/16" (16.83 x 9.05 x 2.54 cm) through (31.75 x 19.05 x 5.88 cm)

BOX DIAGRAM	MODEL NUMBER	STOCK NUMBER	FAMILY	BOX MATERIAL	DIMENSIONS (INSIDE: L X W X D)	PACKED
 1 Compartment	New! WT3000	6723TE	Waterproof Tuff Tainer®-Series	TP	6-5/8" x 3-9/16" x 1.0" (16.83 x 9.05 x 2.54 cm)	12/ctn
 1 Compartment	New! WT4000	6741TE	Waterproof Tuff Tainer®-Series	TP	9-5/16" x 5-13/16" x 1-1/4" (23.65 x 14.77 x 3.18 cm)	12/ctn
 1 Compartment	New! WT5000	6750TE	Waterproof Tuff Tainer®-Series	TP	12-1/2" x 7-1/2" x 1-7/16" (31.75 x 19.05 x 3.65 cm)	12/ctn
 1 Compartment	New! WT5001	6751TE	Waterproof Tuff Tainer®-Series	TP	12-1/2" x 7-1/2" x 2-5/16" (31.75 x 19.05 x 5.88 cm)	12/ctn



Waterproof Tuff Tainers are clear, open core compartment boxes that are equipped with tight sealing latches and a waterproof gasket seal. Great for protecting valuable electronic equipment and other water sensitive items.



* Adding color to the resins effects the clarity of the finished product



For Customer Service Inquiries Call: 1(800) 344-5716





K-Series Boxes

Styrene Butadiene Copolymer

Noted for heavy-duty application, this styrene butadiene copolymer box has excellent impact properties and also maintains scratch-resistant and transparent properties.

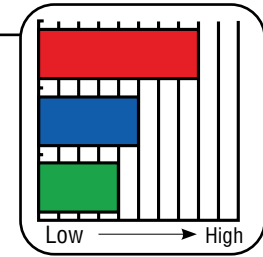

- Clarity*
- Impact Resistance
- Chemical Resistance



Compartment Boxes

SIZES 4-3/8" x 2-5/8" x 1.0" through 8.0" x 4.0" x 1-3/16"
(11.11 x 6.67 x 2.54 cm) through (20.32 x 10.16 x 3.02 cm)











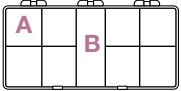

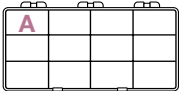

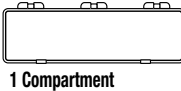
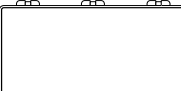

BOX MATERIAL KEY

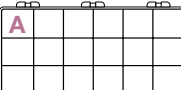
- TP** = Translucent Polypropylene
- YP** = Yellow Polypropylene
- WP** = White Polypropylene
- TCP** = Transparent Cellulose Propionate
- SBMM** = Styrene-Butadiene Methyl Methacrylate
- SBC** = Styrene-Butadiene Copolymer

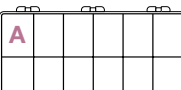
SYMBOL KEY

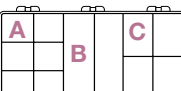
- = Blue Diamond
- = Special Order

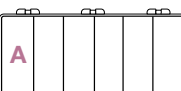
BOX DIAGRAM	MODEL NUMBER	STOCK NUMBER	FAMILY	BOX MATERIAL	DIMENSIONS (INSIDE: L X W X D)	PACKED
 1 Compartment	K226	6644KB	K-Series	SBC	4-3/8" x 2-5/8" x 1.0" (11.11 x 6.67 x 2.54 cm)	36/ctn
 6 Compartments (L x W): A = 1-3/8" x 1-1/4" (3.49 x 3.18 cm)	K220	6640KB	K-Series	SBC	4-3/8" x 2-5/8" x 1.0" (11.11 x 6.67 x 2.54 cm)	36/ctn
 5 Compartments (L x W): A = 1-5/16" x 3-3/16" (3.33 x 8.10 cm)	K215	6630KB	K-Series	SBC	6-3/4" x 3-3/16" x 1-3/16" (17.15 x 8.10 x 3.02 cm)	36/ctn

BOX DIAGRAM	MODEL NUMBER	STOCK NUMBER	FAMILY	BOX MATERIAL	DIMENSIONS (INSIDE: L X W X D)	PACKED
 <p>9 Compartments (L x W): A= 1-5/16" x 1-9/16" (3.33 x 3.97 cm), B= 1-1/8" x 3-3/16" (2.86 x 8.10 cm)</p>	K210 	6622KB	K-Series	SBC	6-3/4" x 3-3/16" x 1-3/16" (17.15 x 8.10 x 3.02 cm)	36/ctn
 <p>12 Compartments (L x W): A= 1-7/16" x 1-1/16" (3.65 x 2.70 cm)</p>	K219 	6636KB	K-Series	SBC	6-3/4" x 3-3/16" x 1-3/16" (17.15 x 8.10 x 3.02 cm)	36/ctn
 <p>1 Compartment</p>	K216 	6632KB	K-Series	SBC	6-3/4" x 3-3/16" x 1-3/16" (17.15 x 8.10 x 3.02 cm)	36/ctn
 <p>1 Compartment</p>	K701	6670KB	K-Series	SBC	6-7/8" x 2-1/16" x 1.0" (17.46 x 5.24 x 2.54 cm)	36/ctn
 <p>1 Compartment</p>	K206 	6616KB	K-Series	SBC	8.0" x 4.0" x 1-3/16" (20.32 x 10.16 x 3.02 cm)	24/ctn
 <p>18 Compartments (L x W): A= 1-1/4" x 1-1/4" (3.18 x 3.18 cm)</p>	K200 	6608KB	K-Series	SBC	8.0" x 4.0" x 1-3/16" (20.32 x 10.16 x 3.02 cm)	24/ctn
 <p>12 Compartments (L x W): A= 1-1/4" x 1-15/16" (3.18 x 4.92 cm)</p>	K208 	6618KB	K-Series	SBC	8.0" x 4.0" x 1-3/16" (20.32 x 10.16 x 3.02 cm)	24/ctn
 <p>12 Compartments (L x W): A= 1-5/16" x 1-5/16" (3.33 x 3.33 cm), B= 1-5/16" x 4.0" (3.33 x 10.16 cm), C= 1-5/16" x 2.0" (3.33 x 5.08 cm)</p>	K201 	6610KB	K-Series	SBC	8.0" x 4.0" x 1-3/16" (20.32 x 10.16 x 3.02 cm)	24/ctn
 <p>6 Compartments (L x W): A= 1-1/4" x 4.0" (3.18 x 10.16 cm)</p>	K203 	6612KB	K-Series	SBC	8.0" x 4.0" x 1-3/16" (20.32 x 10.16 x 3.02 cm)	24/ctn



* Adding color to the resins effects the clarity of the finished product

For Customer Service Inquiries Call: 1(800) 344-5716





SIZES 9-5/8" x 6-9/16" x 1-1/2" through 12-3/4" x 8-1/2" x 2-1/8"
 (24.45 x 16.69 x 3.81 cm) through (32.39 x 21.59 x 5.40 cm)

BOX MATERIAL KEY











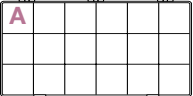

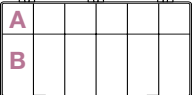

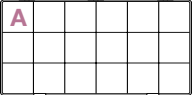
TP = Translucent Polypropylene **TCP** = Transparent Cellulose Propionate **SP** = Taupe Polypropylene
YP = Yellow Polypropylene **SBMM** = Styrene-Butadiene Methyl Methacrylate **OP** = Orange Polypropylene
WP = White Polypropylene **SBC** = Styrene-Butadiene Copolymer

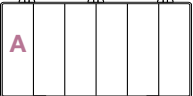
SYMBOL KEY

 = Blue Diamond
 = Special Order

BOX DIAGRAM	MODEL NUMBER	STOCK NUMBER	FAMILY	BOX MATERIAL	DIMENSIONS (INSIDE: L X W X D)	PACKED
 36 Compartments (L x W): A= 1-9/16" x 1-1/16" (3.97 x 2.70 cm)	K166-36 	6606KB	K-Series	SBC	9-5/8" x 6-9/16" x 1-1/2" (24.45 x 16.69 x 3.81 cm)	24/ctn
 4 Compartments 12 Removable Dividers (L x W): A= 10-3/8" x 1-1/2" (26.35 x 3.81 cm)	K616R 	6665KB	K-Series	SBC	10-1/2" x 6-3/16" x 1-9/16" (26.67 x 15.72 x 3.97 cm)	24/ctn
 13 Compartments (L x W): A= 10-3/8" x 2-5/8" (26.35 x 6.67 cm), B= 1-11/16" x 1-5/16" (4.29 x 3.33 cm), C= 1-11/16" x 2.0" (4.29 x 5.08 cm)	K623 	6668KB	K-Series	SBC	10-1/2" x 6-3/16" x 1-9/16" (26.67 x 15.72 x 3.97 cm)	24/ctn
 12 Compartments (L x W): A= 1-11/16" x 3-1/16" (4.29 x 7.78 cm)	K602	6654KB	K-Series	SBC	10-1/2" x 6-3/16" x 1-9/16" (26.67 x 15.72 x 3.97 cm)	24/ctn
 6 Compartments (L x W): A= 1-11/16" x 6-1/4" (4.29 x 15.88 cm)	K606 	6658KB	K-Series	SBC	10-1/2" x 6-3/16" x 1-9/16" (26.67 x 15.72 x 3.97 cm)	24/ctn
 7 Compartments (L x W): A= 1-11/16" x 2.0" (4.29 x 5.08 cm), B= 10-1/2" x 4-1/16" (26.67 x 10.32 cm)	K607 	6660KB	K-Series	SBC	10-1/2" x 6-3/16" x 1-9/16" (26.67 x 15.72 x 3.97 cm)	24/ctn
 1 Compartment	K601	6652KB	K-Series	SBC	10-1/2" x 6-3/16" x 1-9/16" (26.67 x 15.72 x 3.97 cm)	24/ctn

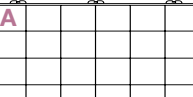
Compt K - Series

BOX DIAGRAM	MODEL NUMBER	STOCK NUMBER	FAMILY	BOX MATERIAL	DIMENSIONS (INSIDE: L X W X D)	PACKED
 18 Compartments (L x W): A= 1-3/4" x 2-1/16" (4.45 x 5.24 cm)	K618 	6666KB	K-Series	SBC	10-1/2" x 6-3/16" x 1-9/16" (26.67 x 15.72 x 3.97 cm)	24/ctn
 12 Compartments (L x W): A= 1-11/16" x 2.0" (4.29 x 5.08 cm), B= 1-11/16" x 4-1/8" (4.29 x 10.48 cm)	K612D 	6663DK	K-Series	SBC	10-1/2" x 6-3/16" x 2-1/4" (26.67 x 15.72 x 5.72 cm)	24/ctn
 18 Compartments (L x W): A= 1-3/4" x 2-1/16" (4.45 x 5.24 cm)	K618D 	6666DK	K-Series	SBC	10-1/2" x 6-3/16" x 2-1/4" (26.67 x 15.72 x 5.72 cm)	24/ctn
 6 Compartments (L x W): A= 1-11/16" x 6-1/4" (4.29 x 15.88 cm)	K606D 	6658DK	K-Series	SBC	10-1/2" x 6-3/16" x 2-1/4" (26.67 x 15.72 x 5.72 cm)	24/ctn
 1 Compartment	K601D 	6652DK	K-Series	SBC	10-1/2" x 6-3/16" x 2-1/4" (26.67 x 15.72 x 5.72 cm)	24/ctn
 1 Compartment	K801 	6672KB	K-Series	SBC	12-3/4" x 8-1/2" x 2-1/8" (32.39 x 21.59 x 5.40 cm)	12/ctn
 12 Compartments (L x W): A= 2-1/16" x 4-3/16" (5.24 x 12.22 cm)	K812	6676KB	K-Series	SBC	12-3/4" x 8-1/2" x 2-1/8" (32.39 x 21.59 x 5.40 cm)	12/ctn
 24 Compartments (L x W): A= 2-1/16" x 2-1/16" (5.24 x 5.24 cm)	K824 	6680KB	K-Series	SBC	12-3/4" x 8-1/2" x 2-1/8" (32.39 x 21.59 x 5.40 cm)	12/ctn

* Adding color to the resins effects the clarity of the finished product



For Customer Service Inquiries Call: 1(800) 344-5716





SIZES 12-3/4" x 8-1/2" x 2-1/8" through 12-3/4" x 8-1/2" x 2-1/8"
 (32.39 x 21.59 x 5.40 cm) through (32.39 x 21.59 x 5.40 cm)

BOX MATERIAL KEY

TP = Translucent Polypropylene **TCP** = Transparent Cellulose Propionate **SP** = Taupe Polypropylene
YP = Yellow Polypropylene **SBMM** = Styrene-Butadiene Methyl Methacrylate **OP** = Orange Polypropylene
WP = White Polypropylene **SBC** = Styrene-Butadiene Copolymer

SYMBOL KEY

 = Blue Diamond
 = Special Order

BOX DIAGRAM	MODEL NUMBER	STOCK NUMBER	FAMILY	BOX MATERIAL	DIMENSIONS (INSIDE: L X W X D)	PACKED
-------------	--------------	--------------	--------	--------------	--------------------------------	--------

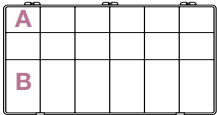

K818

6678KB

K-Series

SBC

12-3/4" x 8-1/2" x 2-1/8"
 (32.39 x 21.59 x 5.40 cm)

12/ctn

18 Compartments (L x W): **A**= 2-1/16" x 2-1/16" (5.24 x 5.24 cm), **B**= 2-1/16" x 4-3/16" (5.24 x 12.22 cm)

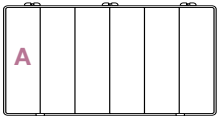

K806

6674KB

K-Series

SBC

12-3/4" x 8-1/2" x 2-1/8"
 (32.39 x 21.59 x 5.40 cm)

12/ctn

6 Compartments (L x W): **A**= 2-1/16" x 8-1/2" (5.24 x 21.59 cm)

* Adding color to the resins effects the clarity of the finished product

Compt K - Series



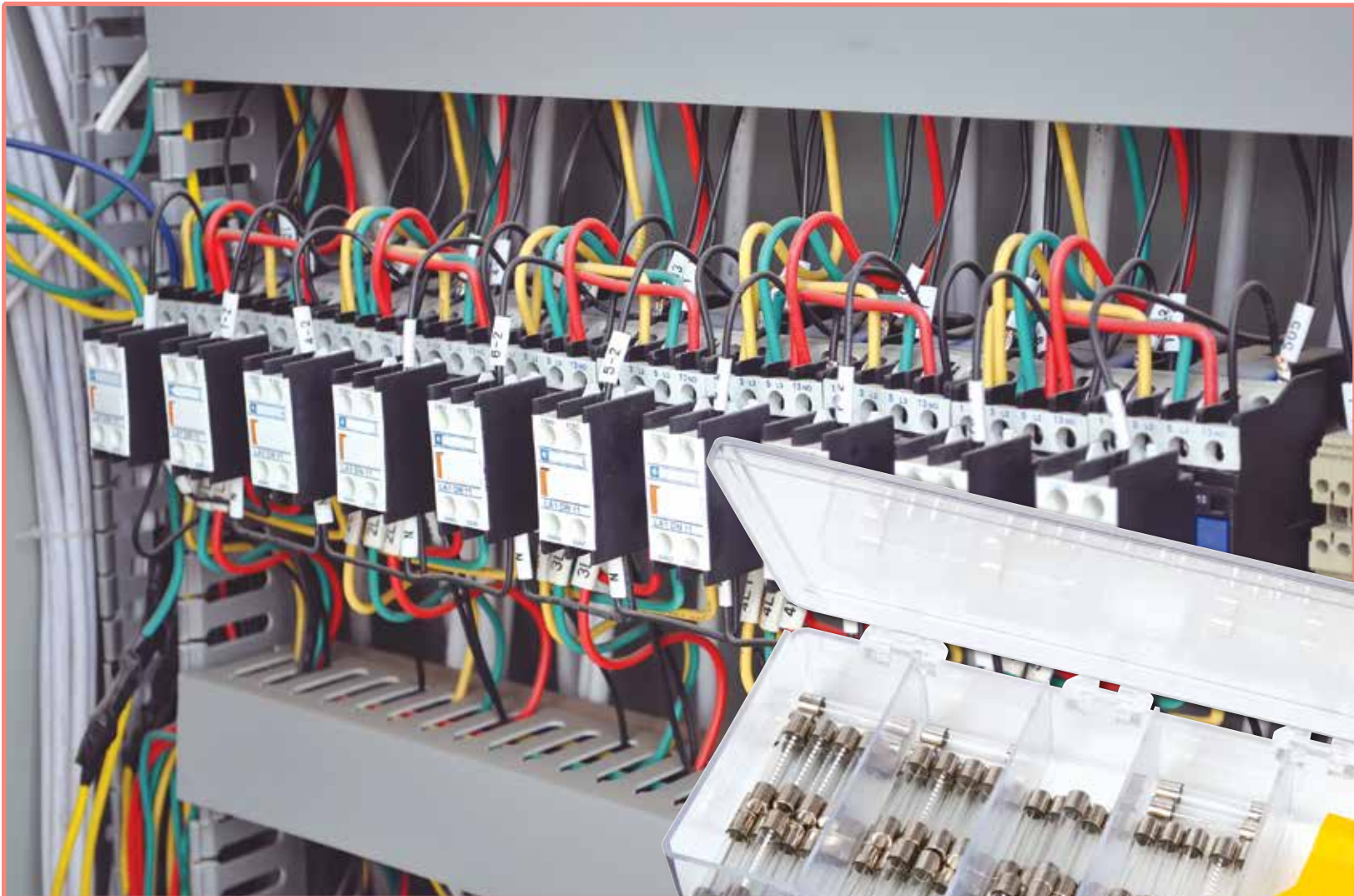

For Customer Service Inquiries Call: 1(800) 344-5716





IDS™ -Series Boxes

Polypropylene

Our Infinite Divider System™ (IDS) box, made of polypropylene, features patented flexibility by allowing each divider to be moved 1/16" (0.16 cm) along the ribbed compartment. Select IDS boxes fit the IDS Cabinet shown on (page 94).

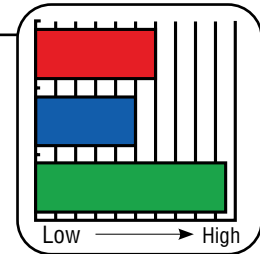

- Clarity*
- Impact Resistance
- Chemical Resistance



Compartment Boxes

SIZES 6-5/8" x 3-3/8" x 1-5/16" through 13-1/8" x 8-7/8" x 1-15/16"
(16.83 x 8.57 x 3.33 cm) through (33.34 x 22.54 x 4.92 cm)

BOX MATERIAL KEY

- TP** = Translucent Polypropylene
- YP** = Yellow Polypropylene
- WP** = White Polypropylene
- TCP** = Transparent Cellulose Propionate
- SBMM** = Styrene-Butadiene Methyl Methacrylate
- SBC** = Styrene-Butadiene Copolymer

SYMBOL KEY

- = Blue Diamond
- = Special Order

BOX DIAGRAM	MODEL NUMBER	STOCK NUMBER	FAMILY	BOX MATERIAL	DIMENSIONS (INSIDE: L X W X D)	PACKED
	T300	6715ID	IDS™-Series	TP	6-5/8" x 3-3/8" x 1-5/16" (16.83 x 8.57 x 3.33 cm)	12/ctn
3 Compartments & 6 IDS Dividers (Ref. page 5) (L x W): A= 6-5/8" x 1-1/16" (16.83 x 2.70 cm)						
	T600	6719ID	IDS-Series	TP	10-1/2" x 6-3/16" x 1-9/16" (26.67 x 15.72 x 3.97 cm)	6/ctn
6 Compartments & 10 IDS Dividers (Ref. page 5) (L x W): A= 1-11/16" x 6-3/16" (4.29 x 15.72 cm)						
	999-2	6726ID	IDS-Series	TP	13-1/8" x 8-7/8" x 1-15/16" (33.34 x 22.54 x 4.92 cm)	6/ctn
4 Compartments with Handle & 16 IDS Dividers (Ref. page 5) (L x W): A= 13-1/8" x 2-1/8" (33.34 x 5.40 cm)						

BOX DIAGRAM	MODEL NUMBER	STOCK NUMBER	FAMILY	BOX MATERIAL	DIMENSIONS (INSIDE: L X W X D)	PACKED
-------------	--------------	--------------	--------	--------------	--------------------------------	--------

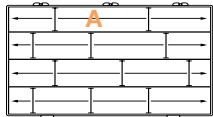

T900 

6725ID

IDS™-Series

TP

13-1/8" x 8-7/8" x 1-15/16"
(33.34 x 22.54 x 4.92 cm)

6/ctn

4 Compartments & 16 IDS Dividers (Ref. page 5) (L x W): A= 13-1/8" x 2-1/8" (33.34 x 5.40 cm)

** Adding color to the resins effects the clarity of the finished product*



See (page 5) for Infinite Divider System™ (IDS) Dividers



For Customer Service Inquiries Call: 1(800) 344-5716





T-Series Boxes

Polypropylene

T-Series boxes provide the same durable construction as the popular M-Series, but are made with translucent polypropylene. These boxes are perfect for “visualizing” components within the box. The T-Series are impervious to most household chemicals, solvents, and gasoline. Great for storage and protection.

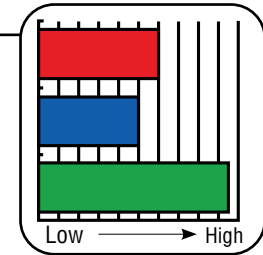

- Clarity*
- Impact Resistance
- Chemical Resistance



Compartment Boxes

SIZES

4.0" x 3-3/8" x 13/16" through 10-1/2" x 6-3/16" x 1-9/16"
 (10.16 x 8.57 x 2.06 cm) through (26.67 x 15.72 x 3.97 cm)

BOX MATERIAL KEY

- TP** = Translucent Polypropylene
- YP** = Yellow Polypropylene
- WP** = White Polypropylene
- TCP** = Transparent Cellulose Propionate
- SBMM** = Styrene-Butadiene Methyl Methacrylate
- SBC** = Styrene-Butadiene Copolymer

- SP** = Taupe Polypropylene
- OP** = Orange Polypropylene

SYMBOL KEY

- = Blue Diamond
- = Special Order

BOX DIAGRAM	MODEL NUMBER	STOCK NUMBER	FAMILY	BOX MATERIAL	DIMENSIONS (INSIDE: L X W X D)	PACKED
 1 Compartments	2040-2	6242FA	T-Series	WP	4.0" x 3-3/8" x 13/16" (10.16 x 8.57 x 2.06 cm)	36/ctn
 4 Compartments (L x W): A = 2-3/16" x 1-5/16" (5.56 x 3.33 cm)	T221	6706TE	T-Series	TP	4-3/8" x 2-5/8" x 1.0" (11.11 x 6.67 x 2.54 cm)	36/ctn
 6 Compartments (L x W): A = 1-3/8" x 1-1/4" (3.49 x 3.18 cm)	T220	6704TE	T-Series	TP	4-3/8" x 2-5/8" x 1.0" (11.11 x 6.67 x 2.54 cm)	36/ctn

BOX DIAGRAM	MODEL NUMBER	STOCK NUMBER	FAMILY	BOX MATERIAL	DIMENSIONS (INSIDE: L X W X D)	PACKED
 5 Compartments (L x W): A= 1.0" x 2-7/8" (2.54 x 7.30 cm)	T155	6688TE	T-Series	TP	5-5/8" x 2-15/16" x 1-1/8" (14.29 x 7.46 x 2.86 cm)	36/ctn
 5 Compartments (L x W): A= 1-5/16" x 3-3/16" (3.33 x 8.10 cm)	T215	6702TE	T-Series	TP	6-3/4" x 3-3/16" x 1-3/16" (17.15 x 8.10 x 3.02 cm)	36/ctn
 9 Compartments (L x W): A= 1-5/16" x 1-9/16" (3.33 x 3.97 cm), B= 1-1/8" x 3-3/16" (2.86 x 8.10 cm)	T210	6698TE	T-Series	TP	6-3/4" x 3-3/16" x 1-3/16" (17.15 x 8.10 x 3.02 cm)	36/ctn
 12 Compartments (L x W): A= 1-7/16" x 1-1/16" (3.65 x 2.70 cm)	T219	6701TE	T-Series	TP	6-3/4" x 3-3/16" x 1-3/16" (17.15 x 8.10 x 3.02 cm)	36/ctn
 18 Compartments (L x W): A= 1-1/4" x 1-1/4" (3.18 x 3.18 cm)	T200	6690TE	T-Series	TP	8.0" x 4.0" x 1-3/16" (20.32 x 10.16 x 3.02 cm)	24/ctn
 12 Compartments (L x W): A= 1-5/16" x 1-5/16" (3.33 x 3.33 cm), B= 1-5/16" x 4.0" (3.33 x 10.16 cm), C= 1-5/16" x 2.0" (3.33 x 5.08 cm)	T201	6692TE	T-Series	TP	8.0" x 4.0" x 1-3/16" (20.32 x 10.16 x 3.02 cm)	24/ctn
 6 Compartments (L x W): A= 1-1/4" x 4.0" (3.18 x 10.16 cm)	T203	6694TE	T-Series	TP	8.0" x 4.0" x 1-3/16" (20.32 x 10.16 x 3.02 cm)	24/ctn
 4 Compartments & 12 Removable Dividers (L x W): A= 10-3/8" x 1-1/2" (26.35 x 3.81 cm)	T616R	6713TE	T-Series	TP	10-1/2" x 6-3/16" x 1-9/16" (26.67 x 15.72 x 3.97 cm)	24/ctn
 13 Compartments (L x W): A= 10-3/8" x 2-5/8" (26.35 x 6.67 cm), B= 1-11/16" x 1-5/16" (4.29 x 3.33 cm), C= 1-11/16" x 2.0" (4.29 x 5.08 cm)	T623	6715TE	T-Series	TP	10-1/2" x 6-3/16" x 1-9/16" (26.67 x 15.72 x 3.97 cm)	24/ctn



For Customer Service Inquiries Call: 1(800) 344-5716





SIZES 10-1/2" x 6-3/16" x 1-9/16" through 13-1/8" x 8-7/8" x 1-15/16"
(26.67 x 15.72 x 3.97 cm) through (33.34 x 22.54 x 4.92 cm)

BOX MATERIAL KEY

TP = Translucent Polypropylene **TCP** = Transparent Cellulose Propionate **SP** = Taupe Polypropylene
YP = Yellow Polypropylene **SBMM** = Styrene-Butadiene Methyl Methacrylate **OP** = Orange Polypropylene
WP = White Polypropylene **SBC** = Styrene-Butadiene Copolymer

SYMBOL KEY

 = Blue Diamond
 = Special Order

BOX DIAGRAM	MODEL NUMBER	STOCK NUMBER	FAMILY	BOX MATERIAL	DIMENSIONS (INSIDE: L X W X D)	PACKED
-------------	--------------	--------------	--------	--------------	--------------------------------	--------

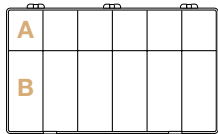

T612

6712TE

T-Series

TP

10-1/2" x 6-3/16" x 1-9/16"
(26.67 x 15.72 x 3.97 cm)

24/ctn

12 Compartments (L x W): **A**= 1-11/16" x 2.0" (4.29 x 5.08 cm), **B**= 1-11/16" x 4-1/8" (4.29 x 10.48 cm)

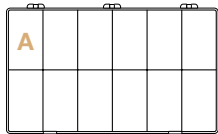

T602

6708TE

T-Series

TP

10-1/2" x 6-3/16" x 1-9/16"
(26.67 x 15.72 x 3.97 cm)

24/ctn

12 Compartments (L x W): **A**= 1-11/16" x 3-1/16" (4.29 x 7.78 cm)

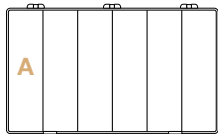

T606 

6710TE

T-Series

TP

10-1/2" x 6-3/16" x 1-9/16"
(26.67 x 15.72 x 3.97 cm)

24/ctn

6 Compartments (L x W): **A**= 1-11/16" x 6-1/4" (4.29 x 15.88 cm)

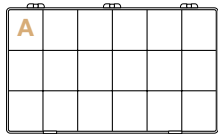

T618 

6714TE

T-Series

TP

10-1/2" x 6-3/16" x 1-9/16"
(26.67 x 15.72 x 3.97 cm)

24/ctn

18 Compartments (L x W): **A**= 1-3/4" x 2-1/16" (4.45 x 5.24 cm)

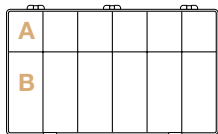

T612D 

6713DB

T-Series

TP

10-1/2" x 6-3/16" x 2-1/4"
(26.67 x 15.72 x 5.72 cm)

24/ctn

12 Compartments (L x W): **A**= 1-11/16" x 2.0" (4.29 x 5.08 cm), **B**= 1-11/16" x 4-1/8" (4.29 x 10.48 cm)

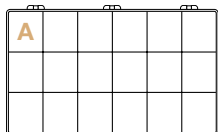

T618D 

6715DB

T-Series







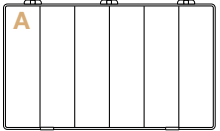

TP

10-1/2" x 6-3/16" x 2-1/4"
(26.67 x 15.72 x 5.72 cm)

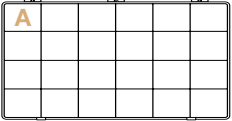
24/ctn

18 Compartments (L x W): **A**= 1-3/4" x 2-1/16" (4.45 x 5.24 cm)

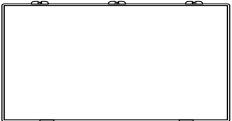
Compt T - Series

BOX DIAGRAM	MODEL NUMBER	STOCK NUMBER	FAMILY	BOX MATERIAL	DIMENSIONS (INSIDE: L X W X D)	PACKED
 <p>6 Compartments (L x W): A= 1-11/16" x 6-1/4" (4.29 x 15.88 cm)</p>	T606D 	6711DB	T-Series	TP	10-1/2" x 6-3/16" x 2-1/4" (26.67 x 15.72 x 5.72 cm)	24/ctn
 <p>24 Compartments (L x W): A= 2-1/16" x 2-1/16" (5.24 x 5.24 cm)</p>	T824 	6726TE	T-Series	TP	12-3/4" x 8-1/2" x 2-1/8" (32.39 x 21.59 x 5.40 cm)	12/ctn
 <p>6 Compartments (L x W): A= 2-1/16" x 8-1/2" (5.24 x 21.59 cm)</p>	T806 	6718TE	T-Series	TP	12-3/4" x 8-1/2" x 2-1/8" (32.39 x 21.59 x 5.40 cm)	12/ctn
 <p>1 Compartment</p>	T901 	6727ID	T-Series	TP	13-1/8" x 8-7/8" x 1-15/16" (33.34 x 22.54 x 4.92 cm)	6/ctn

* Adding color to the resins effects the clarity of the finished product



Same durability and toughness as the M-Series boxes, but translucent.

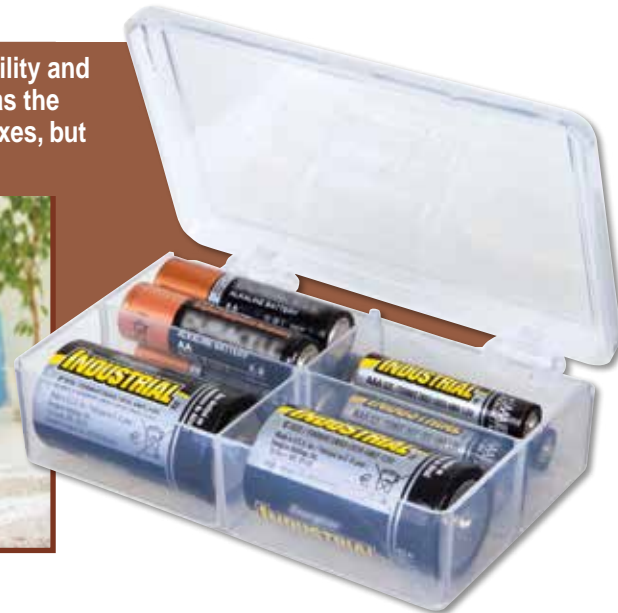

For Customer Service Inquiries Call: 1(800) 344-5716



Compartmental Box Chart: By Dimensions

With the industry's largest selection of sizes and material types you can expect to find what you need right on our shelf. Yet, even with over 300 stock choices, sometimes we have a request for a unique size or compartment configuration. If so, please let us know. Most of our products can be altered

to accommodate a special material or core (compartment) requirement for your project. Finally, we will accommodate you by building a tool specifically for your project right with our Technologies Tool Group.

To help you find what you need we have added a size reference chart that lists all of Flambeau's compartmented boxes from their smallest to largest dimension.

BOX MATERIAL KEY

TP = Translucent Polypropylene

YP = Yellow Polypropylene

WP = White Polypropylene

TCP = Transparent Cellulose Propionate

SBMM = Styrene-Butadiene Methyl Methacrylate

SBC = Styrene-Butadiene Copolymer











SP = Taupe Polypropylene





OP = Orange Polypropylene

SYMBOL KEY

 = Blue Diamond

 = Special Order

DIMENSIONS (INSIDE: L x W x D)	MODEL #	FIXED COMPS	MATERIAL	PAGE
3-11/16" x 2-9/16" x 13/16" (9.37 x 6.51 x 2.06 cm)	2020-2 	1	SBMM	16
 4.0" x 3-2/5" x 1/2" (10.10" x 8.55" x 1.33 cm)	A316-SL 	1	Styrene	15
 4.0" x 3-2/5" x 1/2" (10.10" x 8.55" x 1.33 cm)	A311-SL 	6	Styrene	15
 4.0" x 3-2/5" x 1/2" (10.10" x 8.55" x 1.33 cm)	A313-SL	10	Styrene	15
4.0" x 3-3/8" x 13/16" (10.16" x 8.57" x 2.06 cm)	2040-2 	1	WP	42
4-1/4" Diameter x 3/4" (10.80 Diameter x 1.91 cm)	A01 	1	Styrene	8
4-5/16" x 2-5/8" x 1-1/16" (10.95 x 6.67 x 2.70 cm)	5200CL	1	TCP	22
4-5/16" x 2-5/8" x 1-1/16" (10.95 x 6.67 x 2.70 cm)	5202CL	2	TCP	22
4-5/16" x 2-5/8" x 1-1/16" (10.95 x 6.67 x 2.70 cm)	5204CL	4	TCP	24
4-5/16" x 2-5/8" x 1-1/16" (10.95 x 6.67 x 2.70 cm)	5206CL 	6	TCP	23
4-5/16" x 2-5/8" x 1-1/8" (10.95 x 6.67 x 2.86 cm)	T1002 	4	TP	30
4-3/8" x 2-5/8" x 1.0" (11.11 x 6.67 x 2.54 cm)	A226 K226 	1	Styrene SBC	8 34

DIMENSIONS (INSIDE: L x W x D)	MODEL #	FIXED COMPS	MATERIAL	PAGE
4-3/8" x 2-5/8" x 1.0" (11.11 x 6.67 x 2.54 cm)	A228 	8	Styrene	8
4-3/8" x 2-5/8" x 1.0" (11.11 x 6.67 x 2.54 cm)	A221 T221 M221 	4	Styrene TP YP	9 42 24
4-3/8" x 2-5/8" x 1.0" (11.11 x 6.67 x 2.54 cm)	A220 T220 K220  M220 	6	Styrene TP SBC YP	9 42 34 24
4-1/2" X 2-11/16" x 1.0" (11.43 x 6.83 x 2.54 cm)	DB221	4	Styrene	18
4-1/2" X 2-11/16" x 1.0" (11.43 x 6.83 x 2.54 cm)	DB228 	8	Styrene	18
4-1/2" X 2-11/16" x 1.0" (11.43 x 6.83 x 2.54 cm)	DB220	6	Styrene	18
4-1/2" X 2-11/16" x 1.0" (11.43 x 6.83 x 2.54 cm)	DB226	1	Styrene	19
5-1/8" X 3-9/16" x 1-1/2" (13.02 x 9.05 x 3.81 cm)	A101	1	Styrene	9
5-5/8" X 2-15/16" x 1-1/8" (14.29 x 7.46 x 2.86 cm)	A154	4	Styrene	9
5-5/8" X 2-15/16" x 1-1/8" (14.29 x 7.46 x 2.86 cm)	A155 T155	5	Styrene TP	9 43

Compartmental Box Chart: By Dimensions

DIMENSIONS (INSIDE: L x W x D)	MODEL #	FIXED COMPS	MATERIAL	PAGE
5-5/8" X 3-5/8" x 1-1/8" (14.29 x 9.21 x 2.86 cm)	3030-2	1	SBMM	16
5-7/8" X 3-3/4" x 1-5/8" (14.92 x 9.53 x 4.13 cm)	A250	1	Styrene	9
6-5/8" X 3-3/8" x 1-5/16" (16.83 x 8.57 x 3.33 cm)	T300	3	TP	40
6-5/8" X 3-9/16" x 1.0" (16.83 x 9.05 x 2.54 cm)	WT3000	3	TP	33
6-11/16" X 3-5/16" x 1-5/16" (16.99 x 8.41 x 3.33 cm)	T2003	1	TP	30
6-3/4" X 3-3/16" x 1/2" (17.15 x 8.10 x 1.27 cm)	A213-SL	10	Styrene	15
6-3/4" X 3-3/16" x 1/2" (17.15 x 8.10 x 1.27 cm)	A216-SL	1	Styrene	15
6-3/4" X 3-3/16" x 1/2" (17.15 x 8.10 x 1.27 cm)	A210-SL	9	Styrene	15
6-3/4" X 3-3/16" x 1-3/16" (17.15 x 8.10 x 3.02 cm)	A213	10	Styrene	9
6-3/4" X 3-3/16" x 1-3/16" (17.15 x 8.10 x 3.02 cm)	A214	2	Styrene	9
6-3/4" X 3-3/16" x 1-3/16" (17.15 x 8.10 x 3.02 cm)	A215	5	Styrene	10
	T215		TP	43
	K215		SBC	34
	M215		YP	24
6-3/4" X 3-3/16" x 1-3/16" (17.15 x 8.10 x 3.02 cm)	A210	9	Styrene	10
	T210		TP	43
	K210		SBC	35
	M210		YP	25
6-3/4" X 3-3/16" x 1-3/16" (17.15 x 8.10 x 3.02 cm)	A219	12	Styrene	10
	T219		TP	43
	K219		SBC	35

DIMENSIONS (INSIDE: L x W x D)	MODEL #	FIXED COMPS	MATERIAL	PAGE
6-3/4" X 3-3/16" x 1-3/16" (17.15 x 8.10 x 3.02 cm)	A217	7	Styrene	10
6-3/4" X 3-3/16" x 1-3/16" (17.15 x 8.10 x 3.02 cm)	A211	6	Styrene	10
6-3/4" X 3-3/16" x 1-3/16" (17.15 x 8.10 x 3.02 cm)	A216	1	Styrene	8
	K216		SBC	35
6-3/4" X 3-3/16" x 1-3/16" (17.15 x 8.10 x 3.02 cm)	A212	5	Styrene	10
6-7/8" X 2-1/16" x 1.0" (17.46 x 5.24 x 2.54 cm)	A701	1	Styrene	11
	K701		SBC	35
7.0" X 3-1/4" x 1.0" (17.78 x 8.26 x 2.54 cm)	V301	1	OP	28
	V301PT		SP	28
7.0" X 3-3/8" x 1-1/8" (17.78 x 8.57 x 2.86 cm)	DB216	1	Styrene	19
7.0" X 3-3/8" x 1-1/8" (17.78 x 8.57 x 2.86 cm)	DB211	6	Styrene	19
7.0" X 3-3/8" x 1-1/8" (17.78 x 8.57 x 2.86 cm)	DB219	12	Styrene	19
7.0" X 3-3/8" x 1-1/8" (17.78 x 8.57 x 2.86 cm)	DB210	9	Styrene	19
7.0" X 3-3/8" x 1-1/8" (17.78 x 8.57 x 2.86 cm)	DB213	10	Styrene	19
7.0" X 3-3/8" x 1-1/8" (17.78 x 8.57 x 2.86 cm)	DB217	7	Styrene	19
7.0" X 4.0" x 1-1/16" (17.78 x 10.16 x 2.70 cm)	5126CL	17	TCP	23
7.0" X 4.0" x 1-1/16" (17.78 x 10.16 x 2.70 cm)	5127CL	11	TCP	23
7.0" X 4.0" x 1-1/16" (17.78 x 10.16 x 2.70 cm)	5128CL	6	TCP	23
7-1/8" X 5-1/8" x 1-9/16" (18.10 x 13.02 x 3.97 cm)	A401	1	Styrene	11

Compartment Box Chart: By Dimensions



BOX MATERIAL KEY













TP = Translucent Polypropylene
YP = Yellow Polypropylene
WP = White Polypropylene











TCP = Transparent Cellulose Propionate
SBMM = Styrene-Butadiene Methyl Methacrylate
SBC = Styrene-Butadiene Copolymer

SP = Taupe Polypropylene
OP = Orange Polypropylene

SYMBOL KEY

 = Blue Diamond
 = Special Order

DIMENSIONS (INSIDE: L x W x D)	MODEL #	FIXED COMPS	MATERIAL	PAGE
8.0" X 4.0" x 1-3/16" (20.32 x 10.16 x 3.02 cm)	A204	12	Styrene	11
8.0" X 4.0" x 1-3/16" (20.32 x 10.16 x 3.02 cm)	A206 K206 	1	Styrene SBC	11 35
8.0" X 4.0" x 1-3/16" (20.32 x 10.16 x 3.02 cm)	A209	9	Styrene	11
8.0" X 4.0" x 1-3/16" (20.32 x 10.16 x 3.02 cm)	A200  T200 K200  M200 	18	Styrene TP SBC YP	11 43 35 25
8.0" X 4.0" x 1-3/16" (20.32 x 10.16 x 3.02 cm)	A208  K208  M208	12	Styrene SBC YP	11 35 25
8.0" X 4.0" x 1-3/16" (20.32 x 10.16 x 3.02 cm)	A201 T201 K201  M201	12	Styrene TP SBC YP	11 43 35 25
8.0" X 4.0" x 1-3/16" (20.32 x 10.16 x 3.02 cm)	A203 T203  K203  M203	6	Styrene TP SBC YP	12 43 35 25
8-1/8" X 4-1/8" x 1-3/16" (20.64 x 10.48 x 3.02 cm)	V401 	1	SP	28
8-1/8" X 4-1/8" x 1-3/16" (20.64 x 10.48 x 3.02 cm)	V402-2 	2	SP	29
8-1/8" X 4-1/8" x 2-5/8" (20.64 x 10.48 x 6.67 cm)	V401D-2 	1	SP	29
8-7/16" X 4-1/4" x 1-3/16" (21.43 x 10.80 x 3.02 cm)	DB201	12	Styrene	19

DIMENSIONS (INSIDE: L x W x D)	MODEL #	FIXED COMPS	MATERIAL	PAGE
8-7/16" X 4-1/4" x 1-3/16" (21.43 x 10.80 x 3.02 cm)	DB203	6	Styrene	20
8-7/16" X 4-1/4" x 1-3/16" (21.43 x 10.80 x 3.02 cm)	DB208 	12	Styrene	20
8-7/16" X 4-1/4" x 1-3/16" (21.43 x 10.80 x 3.02 cm)	DB200 	18	Styrene	20
8-7/16" X 4-1/4" x 1-3/16" (21.43 x 10.80 x 3.02 cm)	DB206 	1	Styrene	20
8-7/16" X 4-1/4" x 1-3/16" (21.43 x 10.80 x 3.02 cm)	DB204	12	Styrene	20
8-3/4" X 4-5/16" x 1-1/4" (22.23 x 10.95 x 3.18 cm)	4040-2 	1	SBMM	16
8-7/8" X 4-1/8" x 1-3/16" (22.54 x 10.48 x 3.02 cm)	T3003 	3	TP	30
 9-5/16" X 5-13/16" x 1-1/4" (23.65 x 14.77 x 3.18 cm)	WT4000	1	TP	333
9-5/8" X 6-9/16" x 1-1/2" (24.45 x 16.69 x 3.81 cm)	A166-36 K166-36 	36	Styrene SBC	12 36
10.0" X 4-1/4" x 1-1/2" (25.40 x 10.80 x 3.81 cm)	V501 	1	SP	29
10.0" X 4-1/4" x 1-1/2" (25.40 x 10.80 x 3.81 cm)	V506-2 	6	SP	29
10-1/2" X 6-3/16" x 1-9/16" (26.67 x 15.72 x 3.97 cm)	T616R K616R  M616R 	4	TP SBC YP	43 36 25

Compartment Box Chart: By Dimensions

DIMENSIONS (INSIDE: L x W x D)	MODEL #	FIXED COMPS	MATERIAL	PAGE
10-1/2" X 6-3/16" x 1-9/16" (26.67 x 15.72 x 3.97 cm)	A623 Ⓢ	13	Styrene	12
	T623		TP	43
	K623 Ⓢ		SBC	36
	M623		YP	25
10-1/2" X 6-3/16" x 1-9/16" (26.67 x 15.72 x 3.97 cm)	A612 Ⓢ	12	Styrene	12
	T612		TP	44
	M612		YP	25
10-1/2" X 6-3/16" x 1-9/16" (26.67 x 15.72 x 3.97 cm)	A602	12	Styrene	12
	T602		TP	44
	K602		SBC	36
	M602		YP	26
10-1/2" X 6-3/16" x 1-9/16" (26.67 x 15.72 x 3.97 cm)	A606	6	Styrene	12
	T606 ⚡		TP	45
	K606 ⚡		SBC	36
	M606		YP	26
10-1/2" X 6-3/16" x 1-9/16" (26.67 x 15.72 x 3.97 cm)	A613	13	Styrene	12
10-1/2" X 6-3/16" x 1-9/16" (26.67 x 15.72 x 3.97 cm)	A607 Ⓢ	7	Styrene	13
	K607 Ⓢ		SBC	36
10-1/2" X 6-3/16" x 1-9/16" (26.67 x 15.72 x 3.97 cm)	T600 ⚡	6	TP	40
10-1/2" X 6-3/16" x 1-9/16" (26.67 x 15.72 x 3.97 cm)	A601	1	Styrene	13
	K601		SBC	36
10-1/2" X 6-3/16" x 1-9/16" (26.67 x 15.72 x 3.97 cm)	A618	18	Styrene	13
	T618 ⚡		TP	44
	K618 ⚡		SBC	37
	M618		YP	26
10-1/2" X 6-3/16" x 1-9/16" (26.67 x 15.72 x 3.97 cm)	A603 Ⓢ	3	Styrene	13
10-1/2" X 6-3/16" x 2-1/4" (26.67 x 15.72 x 5.72 cm)	A612D Ⓢ	12	Styrene	13
	T612D Ⓢ		TP	44
	K612D Ⓢ		SBC	37
	M612D Ⓢ		YP	26

DIMENSIONS (INSIDE: L x W x D)	MODEL #	FIXED COMPS	MATERIAL	PAGE
10-1/2" X 6-3/16" x 2-1/4" (26.67 x 15.72 x 5.72 cm)	A618D Ⓢ	18	Styrene	13
	T618D Ⓢ		TP	44
	K618D Ⓢ		SBC	37
	M618D Ⓢ		YP	26
10-1/2" X 6-3/16" x 2-1/4" (26.67 x 15.72 x 5.72 cm)	A601D Ⓢ	1	Styrene	13
	K601D Ⓢ		SBC	37
10-1/2" X 6-3/16" x 2-1/4" (26.67 x 15.72 x 5.72 cm)	A606D Ⓢ	6	Styrene	13
	T606D ⚡		TP	44
	K606D Ⓢ		SBC	37
	M606D Ⓢ		YP	26
10-9/16" X 8-1/4" x 1-9/16" (26.83 x 20.96 x 3.97 cm)	A924-2	24	Styrene	14
10-5/8" X 6-5/8" x 1-9/16" (26.99 x 16.83 x 3.97 cm)	T4004	4	TP	31
10-5/8" X 6-5/8" x 1-9/16" (26.99 x 16.83 x 3.97 cm)	T4007 ⚡	6	TP	31
10-5/8" X 6-5/8" x 1-9/16" (26.99 x 16.83 x 3.97 cm)	T4007AT	6	TP	31
10-5/8" X 6-5/8" x 1-9/16" (26.99 x 16.83 x 3.97 cm)	T4007E ⚡	6	TP	31
10-5/8" X 6-5/8" x 1-9/16" (26.99 x 16.83 x 3.97 cm)	T4000	1	TP	31
10-5/8" X 6-5/8" x 1-9/16" (26.99 x 16.83 x 3.97 cm)	T4008	6	TP	31
11.0" X 6-3/8" x 1-9/16" (27.94 x 16.19 x 3.97 cm)	DB606	6	Styrene	20
11.0" X 6-3/8" x 1-9/16" (27.94 x 16.19 x 3.97 cm)	DB613 ⚡	13	Styrene	20
11.0" X 6-3/8" x 1-9/16" (27.94 x 16.19 x 3.97 cm)	DB601 Ⓢ	1	Styrene	21
11.0" X 6-3/8" x 1-9/16" (27.94 x 16.19 x 3.97 cm)	DB618	18	Styrene	21

Compartment Box Chart: By Dimensions

BOX MATERIAL KEY

TP = Translucent Polypropylene

YP = Yellow Polypropylene

WP = White Polypropylene

TCP = Transparent Cellulose Propionate

SBMM = Styrene-Butadiene Methyl Methacrylate

SBC = Styrene-Butadiene Copolymer









SP = Taupe Polypropylene











OP = Orange Polypropylene

SYMBOL KEY













 = Blue Diamond













 = Special Order

DIMENSIONS (INSIDE: L x W x D)	MODEL #	FIXED COMPS	MATERIAL	PAGE
11-15/16" X 5-15/16" x 1-7/16" (30-32 x 15.08 x 3.65 cm)	5129-1	1	TCP	23
11-15/16" X 5-15/16" x 1-7/16" (30-32 x 15.08 x 3.65 cm)	5129CL	24	TCP	23
11-15/16" X 5-15/16" x 1-7/16" (30-32 x 15.08 x 3.65 cm)	5130CL	6	TCP	23
12.0" x 4.0" x 1-1/16" (30.48 x 10.16 x 2.70 cm)	T3011	1	TP	31
 12-1/2" X 7-1/2" x 1-7/16" (31.75 x 19.05 x 3.65 cm)	WT5000	1	TP	33
 12-1/2" X 7-1/2" x 2-5/16" (31.75 x 19.05 x 5.88 cm)	WT5001	1	TP	33
12-3/4" X 8-1/2" x 2-1/8" (32.39 x 21.59 x 5.40 cm)	M808 	8	YP	26
12-3/4" X 8-1/2" x 2-1/8" (32.39 x 21.59 x 5.40 cm)	A801	1	Styrene	14
	K801 		SBC	37
12-3/4" X 8-1/2" x 2-1/8" (32.39 x 21.59 x 5.40 cm)	A812	12	Styrene	14
	K812		SBC	37
	M812		YP	27
12-3/4" X 8-1/2" x 2-1/8" (32.39 x 21.59 x 5.40 cm)	A824	24	Styrene	14
	T824 		TP	45
	K824 		SBC	37
	M824		YP	27
12-3/4" X 8-1/2" x 2-1/8" (32.39 x 21.59 x 5.40 cm)	A818 	18	Styrene	14
	K818		SBC	38
	M818		YP	27
12-3/4" X 8-1/2" x 2-1/8" (32.39 x 21.59 x 5.40 cm)	A806 	6	Styrene	14
	T806 		TP	45
	K806		SBC	38
	M806		YP	27

DIMENSIONS (INSIDE: L x W x D)	MODEL #	FIXED COMPS	MATERIAL	PAGE
13-1/8" X 8-7/8" x 1-15/16" (33.34 x 22.54 x 4.92 cm)	T901 	1	TP	45
13-1/8" X 8-7/8" x 1-15/16" (33.34 x 22.54 x 4.92 cm)	999-2	4	TP	40
13-1/8" X 8-7/8" x 1-15/16" (33.34 x 22.54 x 4.92 cm)	T900 	4	TP	41
13-1/2" X 5-3/4" x 2.0" (34.29 x 14.61 x 5.08 cm)	V601 	1	SP	29
13-11/16" X 8-3/16" x 1-3/4" (34.77 x 20.80 x 4.45 cm)	T5003 	3	TP	31
13-11/16" X 8-3/16" x 1-3/4" (34.77 x 20.80 x 4.45 cm)	T5007 	4	TP	31
13-11/16" X 8-3/16" x 1-3/4" (34.77 x 20.80 x 4.45 cm)	T5008 	4	TP	32
13-11/16" X 8-3/16" x 1-3/4" (34.77 x 20.80 x 4.45 cm)	T5007AT	4	TP	32
13-11/16" X 8-3/16" x 1-3/4" (34.77 x 20.80 x 4.45 cm)	T5007E 	4	TP	32
15-1/4" X 8-7/8" x 1-3/8" (38.74 x 22.54 x 3.49 cm)	T6004 	6	TP	32
15-1/4" X 8-7/8" x 3.0" (38.74 x 22.54 x 7.62 cm)	T7003	6	TP	32
15-1/4" X 8-7/8" x 3.0" (38.74 x 22.54 x 7.62 cm)	T7004 	7	TP	32
15-1/4" X 8-7/8" x 3.0" (38.74 x 22.54 x 7.62 cm)	T7000 	1	TP	32
17.0" X 7-1/8" x 2.0" (43.18 x 18.10 x 5.08 cm)	V701	1	SP	29

Compartment Box Chart: By Number of Compartments

FIXED COMPS	MODEL #	DIMENSIONS (INSIDE: L x W x D)	MATERIAL	PAGE
1	2020-2 	3-11/16" x 2-9/16" x 13/16" (9.37 x 6.51 x 2.06 cm)	SBMM	16
	A316-SL 	4.0" x 3-2/5" x 1/2" (10.10" x 8.55" x 1.33 cm)	Styrene	15
1	2040-2 	4.0" x 3-3/8" x 13/16" (10.16" x 8.57" x 2.06 cm)	WP	42
1	A01 	4-1/4" Diameter x 3/4" (10.80 Diameter x 1.91 cm)	Styrene	8
1	5200CL	4-5/16" x 2-5/8" x 1-1/16" (10.95 x 6.67 x 2.70 cm)	TCP	22
1	A226 K226 	4-3/8" x 2-5/8" x 1.0" (11.11 x 6.67 x 2.54 cm)	Styrene SBC	8 34
1	DB226	4-1/2" X 2-11/16" x 1.0" (11.43 x 6.83 x 2.54 cm)	Styrene	19
1	A101	5-1/8" X 3-9/16" x 1-1/2" (13.02 x 9.05 x 3.81 cm)	Styrene	9
1	3030-2 	5-5/8" X 3-5/8" x 1-1/8" (14.29 x 9.21 x 2.86 cm)	SBMM	16
1	A250	5-7/8" X 3-3/4" x 1-5/8" (14.92 x 9.53 x 4.13 cm)	Styrene	9
	WT3000	6-5/8" x 3-9/16" x 1.0" (16.83 x 9.05 x 2.54 cm)	TP	33
1	A216-SL 	6-3/4" X 3-3/16" x 1/2" (17.15 x 8.10 x 1.27 cm)	Styrene	15
1	A216  K216 	6-3/4" X 3-3/16" x 1-3/16" (17.15 x 8.10 x 3.02 cm)	Styrene SBC	10 35
1	A701 K701	6-7/8" X 2-1/16" x 1.0" (17.46 x 5.24 x 2.54 cm)	Styrene SBC	11 35
1	V301  V301PT	7.0" X 3-1/4" x 1.0" (17.78 x 8.26 x 2.54 cm)	OP SP	28 28
1	DB216	7.0" X 3-3/8" x 1-1/8" (17.78 x 8.57 x 2.86 cm)	Styrene	19

FIXED COMPS	MODEL #	DIMENSIONS (INSIDE: L x W x D)	MATERIAL	PAGE
1	A401	7-1/8" X 5-1/8" x 1-9/16" (18.10 x 13.02 x 3.97 cm)	Styrene	11
1	A206 K206 	8.0" X 4.0" x 1-3/16" (20.32 x 10.16 x 3.02 cm)	Styrene SBC	11 35
1	V401 	8-1/8" X 4-1/8" x 1-3/16" (20.64 x 10.48 x 3.02 cm)	SP	28
1	V401D-2 	8-1/8" X 4-1/8" x 2-5/8" (20.64 x 10.48 x 6.67 cm)	SP	29
1	DB206 	8-7/16" X 4-1/4" x 1-3/16" (21.43 x 10.80 x 3.02 cm)	Styrene	20
1	4040-2 	8-3/4" X 4-5/16" x 7/8" (22.23 x 10.95 x 2.22 cm)	SBMM	16
	WT4000	9-5/16" x 5-13/16" x 1-1/4" (23.65 x 14.77 x 3.18 cm)	TP	33
1	V501 	10.0" X 4-1/4" x 1-1/2" (25.40 x 10.80 x 3.81 cm)	SP	29
1	A601 K601	10-1/2" X 6-3/16" x 1-9/16" (26.67 x 15.72 x 3.97 cm)	Styrene SBC	13 36
1	A601D  K601D 	10-1/2" X 6-3/16" x 2-1/4" (26.67 x 15.72 x 5.72 cm)	Styrene SBC	13 37
1	T4000	10-5/8" X 6-5/8" x 1-9/16" (26.99 x 16.83 x 3.97 cm)	TP	31
1	DB601 	11.0" X 6-3/8" x 1-9/16" (27.94 x 16.19 x 3.97 cm)	Styrene	21
1	5129-1	11-15/16" X 5-15/16" x 1-7/16" (30.32 x 15.08 x 3.65 cm)	TCP	23
1	T3011	12.0" x 4.0" x 1-1/16" (30.48 x 10.16 x 2.70 cm)	TP	31
	WT5000	12-1/2" x 7-1/2" x 1-7/16" (31.75 x 19.05 x 3.65 cm)	TP	33
	WT5001	12-1/2" x 7-1/2" x 2-5/16" (31.75 x 19.05 x 5.88 cm)	TP	33
1	A801 K801 	12-3/4" X 8-1/2" x 2-1/8" (32.39 x 21.59 x 5.40 cm)	Styrene SBC	14 37

Compartment Box Chart: By Number of Compartments



BOX MATERIAL KEY











TP = Translucent Polypropylene
YP = Yellow Polypropylene
WP = White Polypropylene







TCP = Transparent Cellulose Propionate
SBMM = Styrene-Butadiene Methyl Methacrylate
SBC = Styrene-Butadiene Copolymer

SP = Taupe Polypropylene
OP = Orange Polypropylene

SYMBOL KEY

 = Blue Diamond
 = Special Order

FIXED COMPS	MODEL #	DIMENSIONS (INSIDE: L x W x D)	MATERIAL	PAGE
1	T901 	13-1/8" X 8-7/8" x 1-15/16" (33.34 x 22.54 x 4.92 cm)	TP	45
1	V601 	13-1/2" X 5-3/4" x 2.0" (34.29 x 14.61 x 5.08 cm)	SP	29
1	T7000 	15-1/4" X 8-7/8" x 3.0" (38.74 x 22.54 x 7.62 cm)	TP	32
1	V701	17.0" X 7-1/8" x 2.0" (43.18 x 18.10 x 5.08 cm)	SP	29
2	5200CL	4-5/16" x 2-5/8" x 1-1/16" (10.95 x 6.67 x 2.70 cm)	TCP	22
2	V402-2 	8-1/8" X 4-1/8" x 1-3/16" (20.64 x 10.48 x 3.02 cm)	SP	29
3	T300 	6-5/8" X 3-3/8" x 1-5/16" (16.83 x 8.57 x 3.33 cm)	TP	40
3	T2003 	6-11/16" X 3-5/16" x 1-5/16" (16.99 x 8.41 x 3.33 cm)	TP	30
3	T3003 	8-7/8" X 4-1/8" x 1-3/16" (22.54 x 10.48 x 3.02 cm)	TP	30
3	A603 	10-1/2" X 6-3/16" x 1-9/16" (26.67 x 15.72 x 3.97 cm)	Styrene	13
3	T5003 	13-11/16" X 8-3/16" x 1-3/4" (34.77 x 20.80 x 4.45 cm)	TP	31
4	5204CL	4-5/16" x 2-5/8" x 1-1/16" (10.95 x 6.67 x 2.70 cm)	TCP	22
4	T1002 	4-5/16" x 2-5/8" x 1-1/8" (10.95 x 6.67 x 2.86 cm)	TP	30

FIXED COMPS	MODEL #	DIMENSIONS (INSIDE: L x W x D)	MATERIAL	PAGE
4	A221	4-3/8" x 2-5/8" x 1.0" (11.11 x 6.67 x 2.54 cm)	Styrene	9
	T221		TP	42
	M221 		YP	24
4	DB221	4-1/2" X 2-11/16" x 1.0" (11.43 x 6.83 x 2.54 cm)	Styrene	18
4	A154	5-5/8" X 2-15/16" x 1-1/8" (14.29 x 7.46 x 2.86 cm)	Styrene	9
4	T616R	10-1/2" X 6-3/16" x 1-9/16" (26.67 x 15.72 x 3.97 cm)	TP	43
	K616R 		SBC	36
	M616R 		YP	25
4	T4004	10-5/8" X 6-5/8" x 1-9/16" (26.99 x 16.83 x 3.97 cm)	TP	31
4	999-2	13-1/8" X 8-7/8" x 1-15/16" (33.34 x 22.54 x 4.92 cm)	TP	40
4	T900 	13-1/8" X 8-7/8" x 1-15/16" (33.34 x 22.54 x 4.92 cm)	TP	41
4	T5007 	13-11/16" X 8-3/16" x 1-3/4" (34.77 x 20.80 x 4.45 cm)	TP	31
4	T5008 	13-11/16" X 8-3/16" x 1-3/4" (34.77 x 20.80 x 4.45 cm)	TP	32
4	T5007AT	13-11/16" X 8-3/16" x 1-3/4" (34.77 x 20.80 x 4.45 cm)	TP	32
4	T5007E 	13-11/16" X 8-3/16" x 1-3/4" (34.77 x 20.80 x 4.45 cm)	TP	32
5	A155	5-5/8" X 2-15/16" x 1-1/8" (14.29 x 7.46 x 2.86 cm)	Styrene	9
	T155		TP	43

Compartment Box Chart: By Number of Compartments

FIXED COMPS	MODEL #	DIMENSIONS (INSIDE: L x W x D)	MATERIAL	PAGE
5	A214	6-3/4" X 3-3/16" x 1-3/16" (17.15 x 8.10 x 3.02 cm)	Styrene	9
5	A215	6-3/4" X 3-3/16" x 1-3/16" (17.15 x 8.10 x 3.02 cm)	Styrene	10
	T215		TP	43
	K215		SBC	34
	M215		YP	24
5	A212	6-3/4" X 3-3/16" x 1-3/16" (17.15 x 8.10 x 3.02 cm)	Styrene	10
 6	A311-SL	4.0" x 3-2/5" x 1/2" (10.10" x 8.55" x 1.33 cm)	Styrene	15
6	5206CL	4-5/16" x 2-5/8" x 1-1/16" (10.95 x 6.67 x 2.70 cm)	TCP	23
6	A220	4-3/8" x 2-5/8" x 1.0" (11.11 x 6.67 x 2.54 cm)	Styrene	9
	T220		TP	42
	K220		SBC	34
	M220		YP	24
6	DB220	4-1/2" X 2-11/16" x 1.0" (11.43 x 6.83 x 2.54 cm)	Styrene	18
6	A211	6-3/4" X 3-3/16" x 1-3/16" (17.15 x 8.10 x 3.02 cm)	Styrene	10
6	DB211	7.0" X 3-3/8" x 1-1/8" (17.78 x 8.57 x 2.86 cm)	Styrene	19
6	5128CL	7.0" X 4.0" x 1-1/16" (17.78 x 10.16 x 2.70 cm)	TCP	23
6	A203	8.0" X 4.0" x 1-3/16" (20.32 x 10.16 x 3.02 cm)	Styrene	12
	T203		TP	43
	K203		SBC	35
	M203		YP	25
6	DB203	8-7/16" X 4-1/4" x 1-3/16" (21.43 x 10.80 x 3.02 cm)	Styrene	20
6	V506-2	10.0" X 4-1/4" x 1-1/2" (25.40 x 10.80 x 3.81 cm)	SP	29

FIXED COMPS	MODEL #	DIMENSIONS (INSIDE: L x W x D)	MATERIAL	PAGE
6	A606	10-1/2" X 6-3/16" x 1-9/16" (26.67 x 15.72 x 3.97 cm)	Styrene	12
	T606		TP	44
	K606		SBC	36
	M606		YP	26
6	T600	10-1/2" X 6-3/16" x 1-9/16" (26.67 x 15.72 x 3.97 cm)	TP	40
6	A606D	10-1/2" X 6-3/16" x 2-1/4" (26.67 x 15.72 x 5.72 cm)	Styrene	13
	T606D		TP	45
	K606D		SBC	37
	M606D		YP	26
6	T4007	10-5/8" X 6-5/8" x 1-9/16" (26.99 x 16.83 x 3.97 cm)	TP	31
6	T4007AT	10-5/8" X 6-5/8" x 1-9/16" (26.99 x 16.83 x 3.97 cm)	TP	31
6	T4007E	10-5/8" X 6-5/8" x 1-9/16" (26.99 x 16.83 x 3.97 cm)	TP	31
6	T4008	10-5/8" X 6-5/8" x 1-9/16" (26.99 x 16.83 x 3.97 cm)	TP	31
6	DB606	11.0" X 6-3/8" x 1-9/16" (27.94 x 16.19 x 3.97 cm)	Styrene	20
6	5130CL	11-15/16" X 5-15/16" x 1-7/16" (30.32 x 15.08 x 3.65 cm)	TCP	23
6	A806	12-3/4" X 8-1/2" x 2-1/8" (32.39 x 21.59 x 5.40 cm)	Styrene	14
	T806		TP	45
	K806		SBC	38
	M806		YP	27
6	T6004	15-1/4" X 8-7/8" x 1-3/8" (38.74 x 22.54 x 3.49 cm)	TP	32
6	T7003	15-1/4" X 8-7/8" x 3.0" (38.74 x 22.54 x 7.62 cm)	TP	32
7	A217	6-3/4" X 3-3/16" x 1-3/16" (17.15 x 8.10 x 3.02 cm)	Styrene	10

Compartment Box Chart: By Number of Compartments



BOX MATERIAL KEY











TP = Translucent Polypropylene
YP = Yellow Polypropylene
WP = White Polypropylene







TCP = Transparent Cellulose Propionate
SBMM = Styrene-Butadiene Methyl Methacrylate
SBC = Styrene-Butadiene Copolymer

SP = Taupe Polypropylene
OP = Orange Polypropylene

SYMBOL KEY

 = Blue Diamond
 = Special Order

FIXED COMPS	MODEL #	DIMENSIONS (INSIDE: L x W x D)	MATERIAL	PAGE
7	DB217	7.0" X 3-3/8" x 1-1/8" (17.78 x 8.57 x 2.86 cm)	Styrene	19
7	A607  K607 	10-1/2" X 6-3/16" x 1-9/16" (26.67 x 15.72 x 3.97 cm)	Styrene SBC	13 36
7	T7004 	15-1/4" X 8-7/8" x 3.0" (38.74 x 22.54 x 7.62 cm)	TP	32
8	A228 	4-3/8" x 2-5/8" x 1.0" (11.11 x 6.67 x 2.54 cm)	Styrene	8
8	DB228 	4-1/2" X 2-11/16" x 1.0" (11.43 x 6.83 x 2.54 cm)	Styrene	18
8	M808 	12-3/4" X 8-1/2" x 2-1/8" (32.39 x 21.59 x 5.40 cm)	YP	26
9	A210-SL 	6-3/4" X 3-3/16" x 1/2" (17.15 x 8.10 x 1.27 cm)	Styrene	15
9	A210 T210  K210  M210	6-3/4" X 3-3/16" x 1-3/16" (17.15 x 8.10 x 3.02 cm)	Styrene TP SBC YP	10 43 35 25
9	DB210	7.0" X 3-3/8" x 1-1/8" (17.78 x 8.57 x 2.86 cm)	Styrene	19
9	A209	8.0" X 4.0" x 1-3/16" (20.32 x 10.16 x 3.02 cm)	Styrene	11
	A313-SL	4.0" x 3-2/5" x 1/2" (10.10" x 8.55" x 1.33 cm)	Styrene	15
10	A213-SL	6-3/4" X 3-3/16" x 1/2" (17.15 x 8.10 x 1.27 cm)	Styrene	15

FIXED COMPS	MODEL #	DIMENSIONS (INSIDE: L x W x D)	MATERIAL	PAGE
10	A213	6-3/4" X 3-3/16" x 1-3/16" (17.15 x 8.10 x 3.02 cm)	Styrene	9
10	DB213 	7.0" X 3-3/8" x 1-1/8" (17.78 x 8.57 x 2.86 cm)	Styrene	19
11	5127CL	7.0" X 4.0" x 1-1/16" (17.78 x 10.16 x 2.70 cm)	TCP	23
12	A219 T219 K219 	6-3/4" X 3-3/16" x 1-3/16" (17.15 x 8.10 x 3.02 cm)	Styrene TP SBC	10 43 35
12	DB219	7.0" X 3-3/8" x 1-1/8" (17.78 x 8.57 x 2.86 cm)	Styrene	19
12	A204	8.0" X 4.0" x 1-3/16" (20.32 x 10.16 x 3.02 cm)	Styrene	11
12	A208  K208  M208	8.0" X 4.0" x 1-3/16" (20.32 x 10.16 x 3.02 cm)	Styrene SBC YP	11 35 25
12	A201 T201 K201  M201	8.0" X 4.0" x 1-3/16" (20.32 x 10.16 x 3.02 cm)	Styrene TP SBC YP	11 43 35 25
12	DB201	8-7/16" X 4-1/4" x 1-3/16" (21.43 x 10.80 x 3.02 cm)	Styrene	19
12	DB208 	8-7/16" X 4-1/4" x 1-3/16" (21.43 x 10.80 x 3.02 cm)	Styrene	20

Compartment Box Chart: By Number of Compartments

FIXED COMPS	MODEL #	DIMENSIONS (INSIDE: L x W x D)	MATERIAL	PAGE
12	DB204	8-7/16" X 4-1/4" x 1-3/16" (21.43 x 10.80 x 3.02 cm)	Styrene	20
12	A612 ©	10-1/2" X 6-3/16" x 1-9/16"	Styrene	12
	T612	(26.67 x 15.72 x 3.97 cm)	TP	44
	M612		YP	25
12	A602	10-1/2" X 6-3/16" x 1-9/16"	Styrene	12
	T602	(26.67 x 15.72 x 3.97 cm)	TP	44
	K602		SBC	36
	M602		YP	26
12	A612D ©	10-1/2" X 6-3/16" x 2-1/4"	Styrene	13
	T612D ©	(26.67 x 15.72 x 5.72 cm)	TP	44
	K612D ©		SBC	37
	M612D ©		YP	26
12	A812	12-3/4" X 8-1/2" x 2-1/8"	Styrene	14
	K812	(32.39 x 21.59 x 5.40 cm)	SBC	37
	M812		YP	27
13	A623 ©	10-1/2" X 6-3/16" x 1-9/16"	Styrene	12
	T623	(26.67 x 15.72 x 3.97 cm)	TP	43
	K623 ©		SBC	36
	M623		YP	25
13	A613	10-1/2" X 6-3/16" x 1-9/16" (26.67 x 15.72 x 3.97 cm)	Styrene	12
13	DB613 ⚡	11.0" X 6-3/8" x 1-9/16" (27.94 x 16.19 x 3.97 cm)	Styrene	20
17	5126CL	7.0" X 4.0" x 1-1/16" (17.78 x 10.16 x 2.70 cm)	TCP	23
18	A200 ⚡	8.0" X 4.0" x 1-3/16"	Styrene	11
	T200	(20.32 x 10.16 x 3.02 cm)	TP	43
	K200 ⚡		SBC	35
	M200 ©		YP	25
18	DB200 ⚡	8-7/16" X 4-1/4" x 1-3/16" (21.43 x 10.80 x 3.02 cm)	Styrene	20

FIXED COMPS	MODEL #	DIMENSIONS (INSIDE: L x W x D)	MATERIAL	PAGE
18	A618	10-1/2" X 6-3/16" x 1-9/16"	Styrene	13
	T618 ⚡	(26.67 x 15.72 x 3.97 cm)	TP	44
	K618 ⚡		SBC	37
	M618		YP	26
18	A618D ©	10-1/2" X 6-3/16" x 2-1/4"	Styrene	13
	T618D ©	(26.67 x 15.72 x 5.72 cm)	TP	44
	K618D ©		SBC	37
	M618D ©		YP	26
18	DB618	11.0" X 6-3/8" x 1-9/16" (27.94 x 16.19 x 3.97 cm)	Styrene	21
18	A818 ©	12-3/4" X 8-1/2" x 2-1/8"	Styrene	14
	K818	(32.39 x 21.59 x 5.40 cm)	SBC	38
	M818		YP	27
24	A924-2	10-9/16" X 8-1/4" x 1-9/16" (26.83 x 20.96 x 3.97 cm)	Styrene	14
24	5129CL	11-15/16" X 5-15/16" x 1-7/16" (30.32 x 15.08 x 3.65 cm)	TCP	23
24	A824	12-3/4" X 8-1/2" x 2-1/8"	Styrene	14
	T824 ⚡	(32.39 x 21.59 x 5.40 cm)	TP	45
	K824 ⚡		SBC	37
	M824		YP	27
36	A166-36	9-5/8" X 6-9/16" x 1-1/2"	Styrene	12
	K166-36 ⚡	(24.45 x 16.69 x 3.81 cm)	SBC	36

Cases: Flambeau® Tradesman™ Cases

The original! Any other case resembling this style is a knock-off! These professional hand-held carrying cases are very functional. Commonly used to protect, store & attractively merchandise hundreds of products. Slide open/shut lockable latches with a bead-line seal fit between base and lid complete this exquisite line.



MODEL #	STOCK #	DESCRIPTION	DIMENS (INSIDE: L x W x D)	PACKED
6775TC	6775TC	10-1/2" (26.67 cm) Black - w/Out Foam	9-1/2" x 5-3/4" x 2-3/4" (24.13 x 14.61 x 6.99 cm)	14/ctn
6776TC	6776TC	10-1/2" (26.67 cm) Black - w/Convoluted Foam		
6775WF	6775WF	10-1/2" (26.67 cm) Black - w/Convoluted Foam Lid and Diced Foam Base		
6775TF	6775TF	10-1/2" (26.67 cm) Translucent Clear		
6775TD	6775TD	10-1/2" (26.67 cm) Translucent Blue		
6775TB	6775TB	10-1/2" (26.67 cm) Black/ECO - w/Out Foam		
6780TC	6780TC	14.0" (35.56 cm) Black - w/Out Foam	13-1/4" x 7-3/8" x 3.0" (33.66 x 18.73 x 7.62 cm)	14/ctn
6781TC	6781TC	14.0" (35.56 cm) Black - w/Convoluted Foam		
6780XG	6780XG	14.0" (35.56 cm) Black - w/Convoluted Foam Lid and Diced Foam Base		
6780TN	6780TN	14.0" (35.56 cm) Translucent Clear		
6780TP	6780TP	14.0" (35.56 cm) Translucent Blue		
6780TB	6780TB	14.0" (35.56 cm) Black/ECO - w/Out Foam		
6785TC	6785TC	17.0" (43.18 cm) Black - w/Out Foam	16-3/8" x 9-1/4" x 3-1/2" (41.59 x 23.50 x 8.89 cm)	6/ctn
6785TE	6785TE	17.0" (43.18 cm) Black - w/Convoluted Foam		
6785UP	6785UP	17.0" (43.18 cm) Black - w/Convoluted Foam Lid and Diced Foam Base		
6785TI	6785TI	17.0" (43.18 cm) Translucent Clear		
6785TB	6785TB	17.0" (43.18 cm) Black/ECO - w/Out Foam		

Cases: Merchant™ Cases

All Merchant™ Cases employ shallow lid with deep base functionality. Our cases include the same great features as our Tradesman line, except with a shallow lid and deeper base design. The Merchant 10 and Merchant 15 case handles are designed to provide excellent balance by off-setting the handle for center grasp between the lid and base. Slide open/shut lockable latches with a bead-line seal fit between base and lid complete this exquisite line.



Patent # D650, 585 # D633, 294

Merchant Cases

Shallow lid with deep base functionality!



MODEL #	STOCK #	DESCRIPTION	DIMENSIONS (INSIDE: L x W x D)	PACKED
6767TC	6767TC	7.0" (17.78 cm) Black - w/Out Foam	6-1/2" x 4-1/5" x 2.0" (16.51 x 10.67 x 5.08 cm)	12/ctn
6767TN	6767TN	7.0" (17.78 cm) Translucent Clear		
6772TC	6772TC	10.0" (25.40 cm) Black - w/Out Foam	9.0" x 6-1/2" x 2-3/8" (22.86 x 16.51 x 6.03 cm)	12/ctn
6772TF	6772TF	10.0" (25.40 cm) Black - w/Flat Foam Lid and Convoluted Foam Base		
6772TD	6772TD	10.0" (25.40 cm) Translucent Clear - w/Out Foam		
6772TB	6772TB	10.0" (25.40 cm) Black/ECO - w/Out Foam		
6777TC	6777TC	12.0" (30.48 cm) Black - w/Out Foam	11.0" x 7-1/4" x 3-1/4" (27.94 x 18.41 x 8.25 cm)	12/ctn
6777TF	6777TF	12.0" (30.48 cm) Black - w/Flat Foam Lid and Diced Foam Base		
6777TD	6777TD	12.0" (30.48 cm) Translucent Clear - w/Out Foam		
6777TB	6777TB	12.0" (30.48 cm) Black/ECO - w/Out Foam		
6782TC	6782TC	15.0" (38.10 cm) Black - w/Out Foam	14.0" x 11.0" x 3-2/5" (35.56 x 27.94 x 7.94 cm)	6/ctn
6782TD	6782TD	15.0" (38.10 cm) Trans. Clear - w/Out Foam		
6786TC	6786TC	15.0" (38.10 cm) Black - w/Divided Base and 12 Dividers		
6783TC	6783TC	15.0" (38.10 cm) Black w/Tray, Divided Base and 16 Dividers		



For Customer Service Inquiries Call: 1(800) 344-5716



Cases: Tradesman™ and Merchant™ Case Options

Customization of the Tradesman & Merchant Case:

Customize your Tradesman or Merchant case with options that include engraving, printing, labeling, die-cut foam and the in-mold labeling process which is nearly indestructible and impervious to chemicals.



Custom Options Enhance Interest

Grab attention with attractive designs and colors that outperform your competitor's packaging. Private label any of our boxes to give your company the edge it deserves!



In-Mold Decorating

Achieve high quality, multi-color graphic labeling. The result - better product presentation with guaranteed straight, crisp, clear graphics impervious to most chemicals. **Injection or blow molded products*



Custom Foam

Merchant™ cases offer the best solution when foam is the desired choice for protecting and merchandising your products. The shallow lid design in all Merchant cases minimizes the required use of foam, minimizing cost. The Merchant's deep base is excellent for storing multiple contoured parts.



Even the 7" Merchant Case can have a custom foam interior.

Color Options

Flambeau offers a selection of color resins. Custom blended colors available upon request.

Available Injection Molded Colors:

Taupe PMS 409C	Black PMS 6C	Gray PMS 432C	Yellow PMS 109C	Blue PMS 289C
Orange PMS 1665C	Evergreen PMS 553C	Red PMS 1805C	Translucent Blue PMS 307C	Translucent Red PMS 198C
Translucent Yellow PMS 3955C	Translucent PMS N/A	White PMS 77C	Olive Green PMS 418C	Translucent Green PMS 354C

Available Blow Molded Colors:

Orange PMS 158C	White PMS 77C	Black PMS 6C	Black PMS 6C	White PMS 77C	Blue PMS 286C
Gray PMS 433C	Silver PMS 877C	Blue PMS 307C	Yellow Crown Roll PMS 114C	Green PMS 3308C	Platinum PMS 877C
Red PMS 187C	Yellow PMS 116C	Evergreen PMS 553C	Red PMS 186C	Gold PMS 871C	

Available Hot Stamp Foil Colors:

Black PMS 6C	White PMS 77C	Blue PMS 286C
Yellow Crown Roll PMS 114C	Green PMS 3308C	Platinum PMS 877C
Red PMS 186C	Gold PMS 871C	

Cases: The Defender®



The combination of high-density homopolymer material and double-wall construction offer increased product protection. Can be customized through logo engraving, in-mold permanent labeling, custom colors, foam or molded interior.

Features:

- ProTech™ Latches and Steel Pin-Hinge Construction
- Rear Feet Detail (Offers increased stability for upright display)
- Exterior Banding Strap Detail (Allows case to be used as a shipping container)
- Interior Gasket Seal
- Water- and Chemical-Resistant
- Crush-Resistant and Stackable



The Defender® . . . Just in Case!



See ordering selection and information on next page (60)



For Customer Service Inquiries Call: 1(800) 344-5716



* Express Service (E Symbol) items are for quantities 500 and less. For greater quantities call customer service: 1-800-344-5716.

MODEL #	STOCK #	DESCRIPTION	DIMENSIONS (INSIDE: L x W x D)	DIMENSIONS (OUTSIDE: L x W x D)
50641 E	50641	Defender 12 (DQ 6)	12.0" x 9.0" x 5.0" (30.48 x 22.86 x 12.70)	15-15/16" x 13-1/4" x 6-7/16" (40.48 x 33.65 x 16.35 cm)
50641F E	50641F	Defender 12 (DQ 6) w/Diced Foam	12.0" x 9.0" x 5.0" (30.48 x 22.86 x 12.70)	15-15/16" x 13-1/4" x 6-7/16" (40.48 x 33.65 x 16.35 cm)
50514 E	50514	Defender 17 (DW 6)	15.0" x 12.0" x 5.0" (38.10 x 30.48 x 12.70)	18-1/2" x 15.0" x 6-3/16" (21.59 x 38.10 x 15.72 cm)
50514F E	50514F	Defender 17 (DW 6) w/Diced Foam	15.0" x 12.0" x 5.0" (38.10 x 30.48 x 12.70)	18-1/2" x 15.0" x 6-3/16" (21.59 x 38.10 x 15.72 cm)
50642 E	50642	Defender 18 (DX 7)	15-1/2" x 10-1/4" x 6.0" (39.37 x 26.03 x 15.24)	20-3/4" x 15-3/4" x 7-5/16" (52.70 x 40.0 x 18.57 cm)
50642F E	50642F	Defender 18 (DX 7) w/Diced Foam	15-1/2" x 10-1/4" x 6.0" (39.37 x 26.03 x 15.24)	20-3/4" x 15-3/4" x 7-5/16" (52.70 x 40.0 x 18.57 cm)
50720 E	50720	Defender 23 (DY 9)	19-1/2" x 15.0" x 7-5/16" (49.53 x 38.10 x 18.57)	25-1/4" x 21.0" x 9-3/16" (64.13 x 53.34 x 23.34 cm)
50720F E	50720F	Defender 23 (DY 9) w/Diced Foam	19-1/2" x 15.0" x 7-5/16" (49.53 x 38.10 x 18.57)	25-1/4" x 21.0" x 9-3/16" (64.13 x 53.34 x 23.34 cm)
50720W E	50720W	Defender 23 (DY 9) w/Handle and Wheel Assembly	19-1/2" x 15.0" x 7-5/16" (49.53 x 38.10 x 18.57)	25-1/4" x 21.0" x 9-3/16" (64.13 x 53.34 x 23.34 cm)
50720WF E	50720WF	Defender 23 (DY 9) w/Diced Foam, Handle and Wheel Assembly	19-1/2" x 15.0" x 7-5/16" (49.53 x 38.10 x 18.57)	25-1/4" x 21.0" x 9-3/16" (64.13 x 53.34 x 23.34 cm)
50721 E	50721	Defender 26 (DZ 9)	22-3/4" x 17-3/4" x 8.0" (57.78 x 44.04 x 20.32)	28-3/4" x 24.0" x 9-5/16" (73.02 x 60.96 x 23.65 cm)
50721F E	50721F	Defender 26 (DZ 9) w/Diced Foam	22-3/4" x 17-3/4" x 8.0" (57.78 x 44.04 x 20.32)	28-3/4" x 24.0" x 9-5/16" (73.02 x 60.96 x 23.65 cm)
50721W E	50721W	Defender 26 (DZ 9) w/Handle and Wheel Assembly	22-3/4" x 17-3/4" x 8.0" (57.78 x 44.04 x 20.32)	28-3/4" x 24.0" x 9-5/16" (73.02 x 60.96 x 23.65 cm)
50721WF E	50721WF	Defender 26 (DZ 9) w/Diced Foam, Handle and Wheel Assembly	22-3/4" x 17-3/4" x 8.0" (57.78 x 44.04 x 20.32)	28-3/4" x 24.0" x 9-5/16" (73.02 x 60.96 x 23.65 cm)

Cases: Infinity™ Case

With flair, style and professional presence, the Infinity is designed to give you a high level of protection with a modern look. It features a natural dust seal, double-wall protection in the lid and base, is crush resistant and can withstand a 30 pound impact test. The dual latch system provides easy latching with confidence of security even in the harshest conditions and is available in a variety of sizes and depths (see chart on page 62).

Features:

- Integral or Pin-Hinge
- Water and Chemical-Resistant
- Locking Hole
- Crush-Resistant and Stackable
- Dual Latch System



Double-Wall Protection



Empty



Convoluted & Flat Foam



Convoluted & Diced Foam

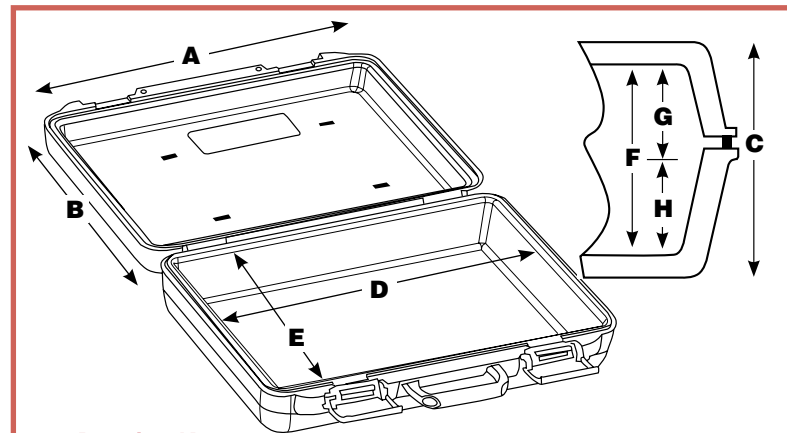

Drawing Key

- | | | |
|-----------------------------|------------------------------|----------------------------------|
| A = Outside Length | B = Outside Width | C = Overall Outside Depth |
| D = Inside Length | E = Interior Width | F = Overall Inside Depth |
| G = Inside Lid Depth | H = Inside Base Depth | |



Infinity Pin Hinge



Infinity Locking Hole



Infinity 14 FV 5

Infinity 10 FH 4

Infinity 12 FQ 2-1/2

Infinity 20 FX 8-1/2

Infinity 12 FQ 4-1/2

Name plate is 5" x 2"

Infinity 27 FZ 8-1/2

Infinity 43 FZ 7

Infinity 14 FV 4



The Infinity lends itself to customization including engraving, printing, labeling, die-cut foam, custom colors and the in-mold labeling/decorating process.

See ordering selection and information on next page (62)



For Customer Service Inquiries Call: 1(800) 344-5716



Cases: The Infinity™ Case

* Express Service (E Symbol) items are for quantities 500 and less. For greater quantities call customer service: 1-800-344-5716.

MODEL #	STOCK #	DESCRIPTION	DIMENS. (INSIDE: L x W x D) (D X E X F)	INSIDE DEPTH (INSIDE: LID, BASE)	DIMENS. (OUTSIDE: L x W x D) (A x B x C)	STANDARD: HANDLE / LATCH
50190 E	50190	Infinity 10 FH4 Foam Available	8-1/4" x 5-7/16" x 3-5/16" (20.96 x 13.81 x 8.41)	Lid: 1-5/16" (3.33 cm) Base: 1-15/16" (4.92 cm)	10-1/8" x 8-1/8" x 4.0" (25.72 x 20.64 x 10.16 cm)	H052 / L089
50250 E	50250	Infinity 12 FQ2-1/2 Foam Available	9-1/2" x 6-5/8" x 1-3/4" (24.13 x 16.83 x 4.45)	Lid: 3/8" (0.95 cm) Base: 1-3/8" (3.49 cm)	12.0" x 9.0" x 2-1/2" (30.48 x 22.864 x 6.35 cm)	NONE / L089
50290 E	50290	Infinity 12 FQ4-1/2 Foam Available	9-1/2" x 6-5/8" x 3-3/16" (24.13 x 16.83 x 4.45)	Lid: 2-7/16" (6.19 cm) Base: 2-3/8" (6.03 cm)	12.0" x 9.0" x 4-1/2" (30.48 x 22.86 x 11.43 cm)	H052 / L089
50330 E	50330	Infinity 14 FV4 Foam Available	11-1/2" x 8-1/2" x 3-3/16" (29.21 x 21.59 x 8.10)	Lid: 1-3/8" (3.49 cm) Base: 1-13/16" (4.60 cm)	14.0" x 10-1/2" x 4.0" (35.56 x 26.67 x 10.16 cm)	H052 / L089
50350 E	50350	Infinity 14 FV5 Foam, Integral Hinge Avail.	11-1/2" x 8-1/2" x 4-1/4" (29.21 x 21.59 x 10.80)	Lid: 1-7/8" (4.76 cm) Base: 2-3/8" (6.03 cm)	14.0" x 10-1/2" x 5.0" (35.56 x 26.67 x 12.70 cm)	H052 / L089
50351 E	50351	Infinity 14 FV5 Foam, Pin Hinge Avail.	11-1/2" x 8-1/2" x 4-1/4" (29.21 x 21.59 x 10.80)	Lid: 1-7/8" (4.76 cm) Base: 2-3/8" (6.03 cm)	14.0" x 10-1/2" x 5.0" (35.56 x 26.67 x 12.70 cm)	H052 / L089
50380 E	50380	Infinity 14 FV6-1/2 Foam Available	11.0" x 7-11/16" x 5-3/4" (27.94 x 19.53 x 14.61)	Lid: 2-1/8" (5.41 cm) Base: 3-1/2" (8.90 cm)	14.0" x 11.0" x 7.0" (35.60 x 28.0 x 17.80 cm)	H023OM / L089
50410 E	50410	Infinity 17 FW4-1/2 Foam Available	14-3/8" x 10.0" x 3-7/16" (36.51 x 25.40 x 8.73)	Lid: 1-1/4" (3.18 cm) Base: 2-3/16" (5.56 cm)	17.0" x 14-1/2" x 4-1/2" (43.18 x 36.83 x 11.43 cm)	H023OM / L085
50430 E	50430	Infinity 17 FW6-1/2 Foam Available	14-3/8" x 10.0" x 5-9/16" (36.51 x 25.40 x 14.13)	Lid: 2-5/16" (5.87 cm) Base: 3-1/4" (8.26 cm)	17.0" x 14-1/2" x 6-1/2" (43.18 x 36.83 x 16.51 cm)	H023OM / L085
50470 E	50470	Infinity 20 FX5-1/2 Foam Available	17-3/4" x 12-5/8" x 4-1/16" (45.09 x 32.07 x 11.75)	Lid: 1-13/16" (4.60 cm) Base: 3.0" (7.62 cm)	20.0" x 15.0" x 5-1/2" (50.80 x 38.10 x 13.97 cm)	H023OM / L095
50500 E	50500	Infinity 20 FX8-1/2 Foam Available	17-3/4" x 12-5/8" x 7-1/2" (45.09 x 32.07 x 19.05)	Lid: 3-1/4" (8.26 cm) Base: 4-1/4" (10.80 cm)	20.0" x 15.0" x 8-1/2" (50.80 x 38.10 x 21.59 cm)	H023OM / L095
50817 E	50817	Infinity 27 FZ8-1/2 Foam Available	24-15/16" x 14-3/16" x 7-1/2" (63.33 x 36.03 x 19.05)	Lid: 1-1/2" (3.81 cm) Base: 6.0" (15.24 cm)	27-3/8" x 18.0" x 8-1/2" (69.53 x 45.72 x 21.59 cm)	H074 / L115
50845 E	50845	Infinity 43 FZ7 Foam Available	40-5/8" x 14-7/16" x 6.0" (103.18 x 36.67 x 15.24)	Lid: 1-1/2" (3.81 cm) Base: 4-1/2" (11.43 cm)	43.0" x 18-15/16" x 7.0" (109.22 x 46.51 x 17.78 cm)	H074 / L116

Cases

Cases: The "P" Series: The Pin-Hinge Case

The "P" Series case is a Flambeau original and has a proven track record in most industries and applications. This is a "pin-hinge" style high-density polyethylene (HDPE) blow molded case. The routed base option is designed to accommodate our standard solid sheet or diced foam and is available in a variety of sizes and depths (see charts on pages 64-65).

Features:

- Heavy-Duty Latches
- Impervious to Most Chemicals / Gasoline
- Double-Wall Protection
- Crush-Resistant and Stackable



Double-Wall Protection



Routed Base

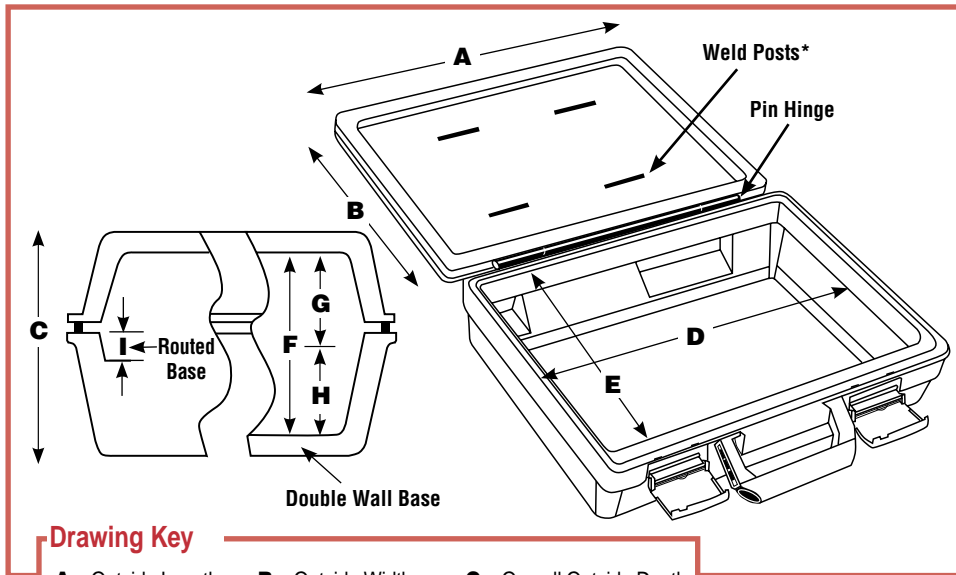

Drawing Key

- A** = Outside Length
- B** = Outside Width
- C** = Overall Outside Depth
- D** = Inside Length
- E** = Interior Width
- F** = Overall Inside Depth
- G** = Inside Lid Depth
- H** = Inside Base Depth
- I** = Routed Depth



The "P" Series is easily customized through engraving, printing, labeling, custom colors, die-cut foam, molded interiors and in-mold decorating/labeling process (molded into the case) which is nearly indestructible.

See ordering selection and information on next page (64-65)



For Customer Service Inquiries Call: 1(800) 344-5716











Cases: The "P" Series: The Pin-Hinge Case

* Express Service (E Symbol) items are for quantities 500 and less.
For greater quantities call customer service: 1-800-344-5716.

MODEL #	STOCK #	DESCRIPTION	DIMENS. (INSIDE: L x W x D) (D X E X F)	INSIDE DEPTH (INSIDE: LID, BASE)	DIMENS. (OUTSIDE: L x W x D) (A x B x C)	STANDARD: HANDLE / LATCH	ROUTED DEPTH = I
18673	18673	PB 1-5/8 Foam Available	6-13/16" x 3-3/16" x 1-5/16" (17.30 x 8.10 x 3.33 cm)	Lid: 1/8" (0.32 cm) Base: 1-3/16" (3.02 cm)	7-1/2" x 4-1/2" x 1-5/8" (19.05 x 11.43 x 4.13 cm)	None / L089	1/4") (0.64 cm)
17873	17873	PC 3-1/8 Foam Available	7-9/16" x 5-7/8" x 2-13/16" (19.21 x 14.92 x 7.14 cm)	Lid: 5/8" (1.59 cm) Base: 2-3/16" (5.56 cm)	8-1/2" x 7-13/16" x 3-1/8" (21.59 x 19.84 x 7.94 cm)	H001 / L089	7/16" (1.11 cm)
50032 E	50032	PC 3-9/16, Foam Avail. Label Area 4-7/8 x 1-7/8 (12.38 x 4.76)	7-9/16" x 5-7/8" x 3-1/4" (19.21 x 14.92 x 8.26 cm)	Lid: 5/8" (1.59 cm) Base: 2-5/8" (6.67 cm)	8-1/2" x 7-13/16" x 3-9/16" (21.59 x 19.84 x 9.05 cm)	H001 / L089	7/16" (1.11 cm)
15865	15865	PC 3-9/16, Label Area 3-1/4 x 1-1/2 (8.26 x 3.81)	7-9/16" x 5-7/8" x 3-1/4" (19.21 x 14.92 x 8.26 cm)	Lid: 5/8" (1.59 cm) Base: 2-5/8" (6.67 cm)	8-1/2" x 7-13/16" x 3-9/16" (21.59 x 19.84 x 9.05 cm)	H001 / L089	7/16" (1.11 cm)
16070	16070	PF 1-3/4	8-5/8" x 4.0" x 1-7/16" (21.91 x 10.16 x 3.65 cm)	Lid: 5/8" (1.59 cm) Base: 13/16" (2.06 cm)	9-1/2" x 5-3/4" x 1-3/4" (24.13 x 14.61 x 4.45 cm)	NONE / L089	7/16" (1.11 cm)
16716	16716	PF 3-1/8	8-5/8" x 4.0" x 2-13/16" (21.91 x 10.16 x 7.14 cm)	Lid: 5/8" (1.59 cm) Base: 3-3/16" (8.10 cm)	9-1/2" x 5-3/4" x 3-1/8" (24.13 x 14.61 x 7.94 cm)	H001 / L089	7/16" (1.11 cm)
50048 E	50048	PH 3-1/8 Foam Available	9-1/8" x 6-1/2" x 2-13/16" (23.18 x 16.51 x 7.14 cm)	Lid: 5/8" (1.59 cm) Base: 2-3/16" (5.56 cm)	10.0" x 8-5/16" x 3-1/8" (25.40 x 21.11 x 7.94 cm)	H001 / L089	7/16" (1.11 cm)
18964	18964	PH 3-7/16	9-1/8" x 6-1/2" x 3-1/8" (23.18 x 16.51 x 7.94 cm)	Lid: 15/16" (2.38 cm) Base: 2-3/16" (5.56 cm)	10.0" x 8-5/16" x 3-7/16" (25.40 x 21.11 x 8.73 cm)	H001 / L089	7/16" (1.11 cm)
17383	17383	PH 3-9/16	9-1/8" x 6-1/2" x 3-1/4" (23.18 x 16.51 x 8.26 cm)	Lid: 5/8" (1.59 cm) Base: 2-5/8" (6.67 cm)	10.0" x 8-5/16" x 3-9/16" (25.40 x 21.11 x 9.05 cm)	H001 / L089	7/16" (1.11 cm)
18290	18290	PH 3-7/8	9-1/8" x 6-1/2" x 3-9/16" (23.18 x 16.51 x 9.05 cm)	Lid: 15/16" (2.38 cm) Base: 2-5/8" (6.67 cm)	10.0" x 8-5/16" x 3-7/8" (25.40 x 21.11 x 9.84 cm)	H001 / L089	7/16" (1.11 cm)
16615	16615	PQ 2-3/8	11-3/8" x 7.0" x 2-1/16" (28.89 x 17.78 x 5.24 cm)	Lid: 15/16" (2.38 cm) Base: 1-1/8" (2.86 cm)	12-1/4" x 8-13/16" x 2-3/8" (31.12 x 22.38 x 6.03 cm)	NONE / L089	7/16" (1.11 cm)
18924	18924	PQ 3-7/16	11-3/8" x 7.0" x 3-1/8" (28.89 x 17.78 x 7.94 cm)	Lid: 15/16" (2.38 cm) Base: 2-3/16" (5.56 cm)	12-1/4" x 8-13/16" x 3-7/16" (31.12 x 22.38 x 8.73 cm)	H052 / L089	7/16" (1.11 cm)
50025 E	50025	PQ 3-7/8 Foam Available	11-3/8" x 7.0" x 3-9/16" (28.89 x 17.78 x 9.05 cm)	Lid: 15/16" (2.38 cm) Base: 2-5/8" (6.67 cm)	12-1/4" x 8-13/16" x 3-7/8" (31.12 x 22.38 x 9.84 cm)	H052 / L089	7/16" (1.11 cm)
15658	15658	PV 3-1/8	12-11/16" x 8-15/16" x 2-13/16" (32.23 x 22.70 x 7.14 cm)	Lid: 5/8" (1.59 cm) Base: 2-3/16" (5.56 cm)	13-1/2" x 10-13/16" x 3-1/8" (34.29 x 27.46 x 7.94 cm)	H052 / L089	7/16" (1.11 cm)
16952	16952	PV 3-7/16	12-11/16" x 8-15/16" x 3-1/8" (32.23 x 22.70 x 7.94 cm)	Lid: 15/16" (2.38 cm) Base: 2-3/16" (5.56 cm)	13-1/2" x 10-13/16" x 3-7/16" (34.29 x 27.46 x 8.73 cm)	H052 / L089	7/16" (1.11 cm)
16541	16541	PV 3-11/16	12-11/16" x 8-15/16" x 3-3/8" (32.23 x 22.70 x 8.57 cm)	Lid: 5/8" (1.59 cm) Base: 2-3/4" (6.99 cm)	13-1/2" x 10-13/16" x 3-11/16" (34.29 x 27.46 x 9.37 cm)	H052 / L089	7/16" (1.11 cm)
50024 E	50024	PV 4 Foam Available	12-11/16" x 8-15/16" x 3-11/16" (32.23 x 22.70 x 9.37 cm)	Lid: 15/16" (2.38 cm) Base: 2-3/4" (6.99 cm)	13-1/2" x 10-13/16" x 4.0" (34.29 x 27.46 x 10.16 cm)	H052 / L089	7/16" (1.11 cm)

Cases

Cases: The "P" Series: The Pin-Hinge Case Continued

MODEL #	STOCK #	DESCRIPTION	DIMENS. (INSIDE: L x W x D) (D X E X F)	INSIDE DEPTH (INSIDE: LID, BASE)	DIMENS. (OUTSIDE: L x W x D) (A x B x C)	STANDARD: HANDLE / LATCH	ROUTED DEPTH = I
50026 	50026	PV 5-1/8 Foam Available	12-11/16" x 8-15/16" x 4-3/4" (32.23 x 22.70 x 12.07 cm)	Lid: 1-1/2" (3.81 cm) Base: 3-1/4" (8.26 cm)	13-1/2" x 10-13/16" x 5-1/8" (34.29 x 27.46 x 13.02 cm)	H052 / L089	7/16" (1.11 cm)
16965	16965	PV 6-1/8 Foam Available	12-11/16" x 8-15/16" x 5-5/8" (32.23 x 22.70 x 14.29 cm)	Lid: 1-7/8" (4.76 cm) Base: 3-3/4" (9.53 cm)	13-1/2" x 10-13/16" x 6-1/8" (34.29 x 27.46 x 15.56 cm)	H052 / L089	7/16" (1.11 cm)
50030 	50030	PW 4 Foam Available	14.0" x 10-3/4" x 3-1/2" (35.56 x 27.31 x 8.89 cm)	Lid: 5/8" (1.59 cm) Base: 2-7/8" (7.30 cm)	15-1/2" x 13-5/16" x 4.0" (39.37 x 33.81 x 10.16 cm)	H023OM / L085	1-1/4" (3.18 cm)
11585	11585	PW 4-3/4	14.0" x 10-3/4" x 4-1/4" (35.56 x 27.31 x 10.80 cm)	Lid: 1-3/8" (3.49 cm) Base: 2-7/8" (7.30 cm)	15-1/2" x 13-5/16" x 4-3/4" (39.37 x 33.81 x 12.07 cm)	H023OM / L085	1-1/4" (3.18 cm)
11598	11598	PW 4-3/4 Double Wall Base	14.0" x 10-3/4" x 4.0" (35.56 x 27.31 x 10.16 cm)	Lid: 1-3/8" (3.49 cm) Base: 2-5/8" (6.67 cm)	15-1/2" x 13-5/16" x 4-3/4" (39.37 x 33.81 x 12.07 cm)	H023OM / L085	1-1/4" (3.18 cm)
11664	11664	PW 5-1/2	14.0" x 10-3/4" x 5.0" (35.56 x 27.31 x 12.70 cm)	Lid: 2-1/8" (5.40 cm) Base: 2-7/8" (7.30 cm)	15-1/2" x 13-5/16" x 5-1/2" (39.37 x 33.81 x 13.97 cm)	H023OM / L085	1-1/4" (3.18 cm)
50053 	50053	PW 6-1/4 Foam Available	14.0" x 10-3/4" x 5-3/4" (35.56 x 27.31 x 14.61 cm)	Lid: 2-1/8" (5.40 cm) Base: 3-5/8" (9.21 cm)	15-1/2" x 13-5/16" x 6-1/4" (39.37 x 33.81 x 15.88 cm)	H023OM / L026	1-1/4" (3.18 cm)
11588	11588	PW 6-1/4	14.0" x 10-3/4" x 5-5/8" (35.56 x 27.31 x 14.29 cm)	Lid: 2-3/4" (6.98 cm) Base: 2-7/8" (7.30 cm)	15-1/2" x 13-5/16" x 6-1/4" (39.37 x 33.81 x 15.88 cm)	H023OM / L085	1-1/4" (3.18 cm)
12090	12090	PX 3-1/2	17.0" x 13.0" x 3.0" (43.18 x 33.02 x 7.62 cm)	Lid: 1-3/8" (3.49 cm) Base: 1-5/8" (4.13 cm)	18-1/2" x 15-9/16" x 3-1/2" (46.99 x 39.53 x 8.89 cm)	Integral / L037	15/16" (2.38 cm)
50050 	50050	PX 5	17.0" x 13.0" x 4-1/2" (43.18 x 33.02 x 11.43 cm)	Lid: 1-3/8" (3.49 cm) Base: 3-1/8" (7.94 cm)	18-1/2" x 15-9/16" x 5.0" (46.99 x 39.53 x 12.70 cm)	H023OM / L026	15/16" (2.38 cm)
12097	12097	PX 6-1/4	17.0" x 13.0" x 5-5/8" (43.18 x 33.02 x 14.29 cm)	Lid: 1-3/4" (4.45 cm) Base: 3-7/8" (9.84 cm)	18-1/2" x 15-9/16" x 6-1/4" (46.99 x 39.53 x 15.88 cm)	Integral / L037	15/16" (2.38 cm)
50051 	50051	PX 8	17.0" x 13.0" x 7-3/8" (43.18 x 33.02 x 18.73 cm)	Lid: 3-1/2" (8.89 cm) Base: 3-7/8" (9.84 cm)	18-1/2" x 15-9/16" x 8.0" (46.99 x 39.53 x 20.32 cm)	H023OM / L026	15/16" (2.38 cm)
12023	12023	PX 8	17.0" x 13.0" x 7-3/8" (43.18 x 33.02 x 18.73 cm)	Lid: 3-1/2" (8.89 cm) Base: 3-7/8" (9.84 cm)	18-1/2" x 15-9/16" x 8.0" (46.99 x 39.53 x 20.32 cm)	H023OM / L085	15/16" (2.38 cm)
18925	18925	PX 8	17.0" x 13.0" x 7.0" (43.18 x 33.02 x 17.78 cm)	Lid: 3-1/2" (8.89 cm) Base: 3-1/2" (8.89 cm)	18-1/2" x 15-9/16" x 8.0" (46.99 x 39.53 x 20.32 cm)	H023OM / L085	15/16" (2.38 cm)
50045 	50045	PZ 4-1/2, Foam Avail. Integral Handle Option	24-1/2" x 13.0" x 3-5/8" (62.23 x 33.02 x 9.21 cm)	Lid: 7/8" (2.22 cm) Base: 2-3/4" (6.99 cm)	26.0" x 15-9/16" x 4-1/2" (66.04 x 39.53 x 11.43 cm)	H023OM / L095	1-1/8" (2.86 cm)
50088 	12414	PZ 8, Foam Avail. Integral Handle Option	24-1/2" x 13.0" x 7-3/8" (62.23 x 33.02 x 18.73 cm)	Lid: 3-1/2" (8.89 cm) Base: 3-7/8" (9.84 cm)	26.0" x 15-9/16" x 8.0" (66.04 x 39.53 x 20.32 cm)	H023OM / L095	1-1/8" (2.86 cm)
50415 	12415	PZ 9	24-1/2" x 13.0" x 8-3/8" (62.23 x 33.02 x 21.27 cm)	Lid: 3-1/2" (8.89 cm) Base: 4-7/8" (12.38 cm)	26.0" x 15-9/16" x 9.0" (66.04 x 39.53 x 22.86 cm)	H023OM / L095	1-1/8" (2.86 cm)



For Customer Service Inquiries Call: 1(800) 344-5716



Cases: "R" Series Case

The "R" Series case features an integral hinge and latch system. This simple and reliable blow mold case is our most economical case offering. Constructed from high-density polyethylene (HDPE) this case is tough enough for almost any challenge. Available as a double-wall case, or with a routed base to accommodate foam, this case offers maximum protection. A broad range of sizes and depths are available (see charts on pages 66-69).

Features:

- Integral Hinge and Latch
- Crush-Resistant and Stackable
- Option: Double-Wall Protection or Routed Base for Foam Insert

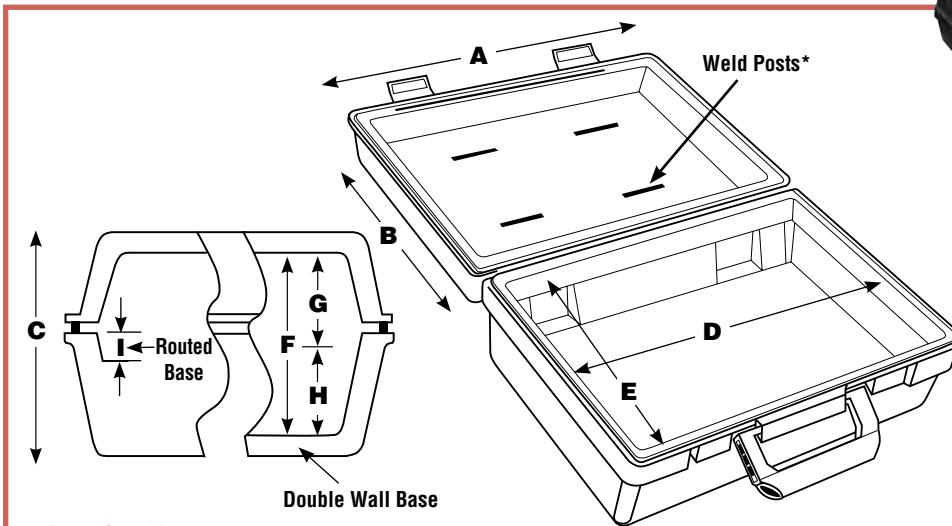

Drawing Key

- A** = Outside Length
- B** = Outside Width
- C** = Overall Outside Depth
- D** = Inside Length
- E** = Interior Width
- F** = Overall Inside Depth
- G** = Inside Lid Depth
- H** = Inside Base Depth
- I** = Routed Depth

* Number of weld posts may vary



Double-Wall Protection or Routed Base to Accommodate Foam

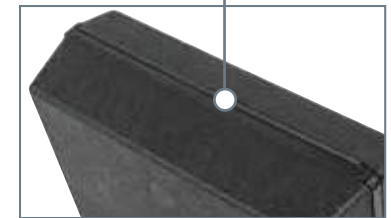

"R" Series Integral Hinge

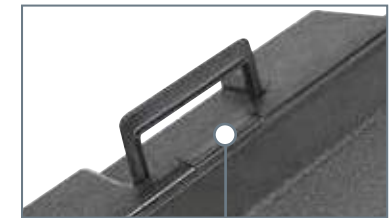

"R" Series Integral Latch

*** Please note: The "R" Series is production-run only, no stock. See ordering selection and information on pages (66-69)**

MODEL #	STOCK #	DESCRIPTION	DIMENS. (INSIDE: L x W x D) (D X E X F)	INSIDE DEPTH (INSIDE: LID, BASE)	DIMENS. (OUTSIDE: L x W x D) (A x B x C)	STANDARD: HANDLE / LATCH	ROUTED DEPTH = I
2504 ©	2504	RA 2-1/16	6-5/8" x 4-3/4" x 1-3/4" (16.83 x 12.07 x 4.45 cm)	Lid: 5/8" (1.59 cm) Base: 1-1/8" (2.86 cm)	7-1/2" x 5-3/4" x 2-1/16" (19.05 x 14.61 x 5.24 cm)	None / Integral	7/16" (1.11 cm)
9431 ©	9431	RA 2-5/8	6-5/8" x 4-3/4" x 2-5/16" (16.83 x 12.07 x 5.87 cm)	Lid: 15/16" (2.38 cm) Base: 1-3/8" (3.49 cm)	7-1/2" x 5-3/4" x 2-5/8" (19.05 x 14.61 x 6.67 cm)	None / Integral	7/16" (1.11 cm)

Cases: "R" Series Case Continued

MODEL #	STOCK #	DESCRIPTION	DIMENS. (INSIDE: L x W x D) (D X E X F)	INSIDE DEPTH (INSIDE: LID, BASE)	DIMENS. (OUTSIDE: L x W x D) (A x B x C)	STANDARD: HANDLE / LATCH	ROUTED DEPTH = I
2505 ©	2505	RA 3-7/16	6-5/8" x 4-3/4" x 3-1/8" (16.83 x 12.07 x 7.94 cm)	Lid: 1.0" (2.54 cm) Base: 2-3/16" (5.56 cm)	7-1/2" x 5-3/4" x 3-7/16" (19.05 x 14.61 x 8.73 cm)	None / Integral	7/16" (1.11 cm)
48-9411 ©	48-9411	RB 1-1/4	6-13/16" x 3-3/16" x 15/16" (17.30 x 8.10 x 2.38 cm)	Lid: 1/8" (0.32 cm) Base: 13/16" (2.06 cm)	7-1/2" x 4.0" x 1-1/4" (19.05 x 10.16 x 3.18 cm)	None / Integral	1/4" (0.64 cm)
48-9512 ©	48-9512	RB 1-5/8	6-13/16" x 3-3/16" x 1-5/16" (17.30 x 8.10 x 3.33 cm)	Lid: 1/8" (0.32 cm) Base: 1-3/16" (3.02 cm)	7-1/2" x 4.0" x 1-5/8" (19.05 x 10.16 x 1.59 cm)	None / Integral	1/4" (0.64 cm)
48-9513 ©	48-9513	RB 1-5/8	6-13/16" x 3-3/16" x 1-5/16" (17.30 x 8.10 x 3.33 cm)	Lid: 1/2" (1.27 cm) Base: 13/16" (2.06 cm)	7-1/2" x 4.0" x 1-5/8" (19.05 x 10.16 x 1.59 cm)	None / Integral	1/4" (0.64 cm)
48-9514 ©	48-9514	RB 2	6-13/16" x 3-3/16" x 1-11/16" (17.30 x 8.10 x 4.29 cm)	Lid: 1/2" (1.27 cm) Base: 1-3/16" (3.02 cm)	7-1/2" x 4.0" x 2.0" (19.05 x 10.16 x 5.08 cm)	None / Integral	1/4" (0.64 cm)
48-9515 ©	48-9515	RB 2	6-13/16" x 3-3/16" x 1-11/16" (17.30 x 8.10 x 4.29 cm)	Lid: 7/8" (2.22 cm) Base: 13/16" (2.06 cm)	7-1/2" x 4.0" x 2.0" (19.05 x 10.16 x 5.08 cm)	None / Integral	1/4" (0.64 cm)
48-9516 ©	48-9516	RB 2-3/8	6-13/16" x 3-3/16" x 2-1/16" (17.30 x 8.10 x 5.24 cm)	Lid: 1/2" (1.27 cm) Base: 1-9/16" (3.97 cm)	7-1/2" x 4.0" x 2-3/8" (19.05 x 10.16 x 6.03 cm)	None / Integral	1/4" (0.64 cm)
48-9517 ©	48-9517	RB 2-3/8	6-13/16" x 3-3/16" x 2-1/16" (17.30 x 8.10 x 5.24 cm)	Lid: 7/8" (2.22 cm) Base: 1-3/16" (3.02 cm)	7-1/2" x 4.0" x 2-3/8" (19.05 x 10.16 x 6.03 cm)	None / Integral	1/4" (0.64 cm)
48-9518 ©	48-9518	RB 2-3/4	6-13/16" x 3-3/16" x 2-7/16" (17.30 x 8.10 x 6.19 cm)	Lid: 1/2" (1.27 cm) Base: 1-15/16" (4.92 cm)	7-1/2" x 4.0" x 2-3/4" (19.05 x 10.16 x 6.99 cm)	None / Integral	1/4" (0.64 cm)
48-9519 ©	48-9519	RB 2-3/4	6-13/16" x 3-3/16" x 2-7/16" (17.30 x 8.10 x 6.19 cm)	Lid: 7/8" (2.22 cm) Base: 1-9/16" (3.97 cm)	7-1/2" x 4.0" x 2-3/4" (19.05 x 10.16 x 6.99 cm)	None / Integral	1/4" (0.64 cm)
48-9520 ©	48-9520	RB 3-1/8	6-13/16" x 3-3/16" x 2-13/16" (17.30 x 8.10 x 7.14 cm)	Lid: 7/8" (2.22 cm) Base: 1-15/16" (4.92 cm)	7-1/2" x 4.0" x 3-1/8" (19.05 x 10.16 x 7.94 cm)	None / Integral	1/4" (0.64 cm)
2500 ©	2500	RC 1-3/4	7-9/16" x 5-7/8" x 1-7/16" (19.21 x 14.92 x 3.65 cm)	Lid: 5/8" (1.59 cm) Base: 13/16" (2.06 cm)	8-1/2" x 7.0" x 1-3/4" (21.59 x 17.78 x 4.45 cm)	None / Integral	7/16" (1.11 cm)
2509 ©	2509	RC 2-3/8	7-9/16" x 5-7/8" x 2-1/16" (19.21 x 14.92 x 5.24 cm)	Lid: 1.0" (2.54 cm) Base: 1-1/8" (2.86 cm)	8-1/2" x 7.0" x 2-3/8" (21.59 x 17.78 x 6.03 cm)	None / Integral	7/16"
2513 ©	2513	RC 3-7/8	7-9/16" x 5-7/8" x 3-9/16" (19.21 x 14.92 x 9.05 cm)	Lid: 1.0" (2.54 cm) Base: 2-5/8" (6.67 cm)	8-1/2" x 7.0" x 3-7/8" (21.59 x 17.78 x 9.84 cm)	H001 / Integral	7/16" (1.11 cm)
2524 ©	2524	RF 1-3/4	8-5/8" x 4.0" x 1-7/16" (21.91 x 10.16 x 3.65 cm)	Lid: 5/8" (1.59 cm) Base: 13/16" (2.06 cm)	9-1/2" x 5.0" x 1-3/4" (24.13 x 12.70 x 4.45 cm)	None / Integral	7/16" (1.11 cm)
2527 ©	2527	RF 3-1/8	8-5/8" x 4.0" x 2-13/16" (21.91 x 10.16 x 7.14 cm)	Lid: 5/8" (1.59 cm) Base: 2-3/16" (5.56 cm)	9-1/2" x 5.0" x 3-1/8" (24.13 x 12.70 x 7.94 cm)	H001 / Integral	7/16" (1.11 cm)
2532 ©	2532	RH 1-3/4	9-1/8" x 6-1/2" x 1-7/16" (23.18 x 16.51 x 3.65 cm)	Lid: 5/8" (1.59 cm) Base: 13/16" (2.06 cm)	10.0" x 7-1/2" x 1-3/4" (25.40 x 19.05 x 4.45 cm)	None / Integral	7/16" (1.11 cm)



For Customer Service Inquiries Call: 1(800) 344-5716



Cases: "R" Series Case Continued

MODEL #	STOCK #	DESCRIPTION	DIMENS. (INSIDE: L x W x D) (D X E X F)	INSIDE DEPTH (INSIDE: LID, BASE)	DIMENS. (OUTSIDE: L x W x D) (A x B x C)	STANDARD: HANDLE / LATCH	ROUTED DEPTH = I
2533 ©	2533	RH 2-3/8	9-1/8" x 6-1/2" x 2-1/16" (23.18 x 16.51 x 5.24 cm)	Lid: 1.0" (2.54 cm) Base: 1-1/8" (2.86 cm)	10.0" x 7-1/2" x 2-3/8" (25.40 x 19.05 x 6.03 cm)	None / Integral	7/16" (1.11 cm)
2534 ©	2534	RH 3-1/8	9-1/8" x 6-1/2" x 2-13/16" (23.18 x 16.51 x 7.14 cm)	Lid: 5/8" (1.59 cm) Base: 2-3/16" (5.56 cm)	10.0" x 7-1/2" x 3-1/8" (25.40 x 19.05 x 7.94 cm)	H001 / Integral	7/16" (1.11 cm)
2541 ©	2541	RH 3-7/16	9-1/8" x 6-1/2" x 3-1/8" (23.18 x 16.51 x 7.94 cm)	Lid: 1.0" (2.54 cm) Base: 2-3/16" (5.56 cm)	10.0" x 7-1/2" x 3-7/16" (25.40 x 19.05 x 8.73 cm)	H001 / Integral	7/16" (1.11 cm)
2537 ©	2537	RH 3-7/8	9-1/8" x 6-1/2" x 3-9/16" (23.18 x 16.51 x 9.05 cm)	Lid: 1.0" (2.54 cm) Base: 2-5/8" (6.67 cm)	10.0" x 7-1/2" x 3-7/8" (25.40 x 19.05 x 9.84 cm)	H001 / Integral	7/16" (1.11 cm)
2547 ©	2547	RK 2-3/8	10-1/8" x 4-1/4" x 2-1/16" (25.72 x 10.80 x 5.34 cm)	Lid: 15/16" (2.38 cm) Base: 1-1/8" (2.86 cm)	11.0" x 5-1/4" x 2-3/8" (27.94 x 13.34 x 6.03 cm)	None / Integral	7/16" (1.11 cm)
2549 ©	2549	RK 3-1/8	10-1/8" x 4-1/4" x 2-13/16" (25.72 x 10.80 x 7.14 cm)	Lid: 5/8" (1.59 cm) Base: 2-3/16" (5.56 cm)	11.0" x 5-1/4" x 3-1/8" (27.94 x 13.34 x 7.94 cm)	H001 / Integral	7/16" (1.11 cm)
9624 ©	9624	RK 3-9/16	10-1/8" x 4-1/4" x 3-1/4" (25.72 x 10.80 x 8.26 cm)	Lid: 5/8" (1.59 cm) Base: 2-5/8" (6.67 cm)	11.0" x 5-1/4" x 3-9/16" (27.94 x 13.34 x 9.05 cm)	H001 / Integral	7/16" (1.11 cm)
2560 ©	2560	RN 1-3/4	11-3/8" x 5-1/4" x 1-7/16" (28.89 x 13.34 x 3.65 cm)	Lid: 5/8" (1.59 cm) Base: 13/16" (2.06 cm)	12-1/4" x 6-1/4" x 1-3/4" (31.12 x 15.88 x 4.45 cm)	None / Integral	7/16" (1.11 cm)
2569 ©	2569	RN 3-7/16	11-3/8" x 5-1/4" x 3-1/8" (28.89 x 13.34 x 7.94 cm)	Lid: 15/16" (2.38 cm) Base: 2-3/16" (5.56 cm)	12-1/4" x 6-1/4" x 3-7/16" (31.12 x 15.88 x 8.73 cm)	H001 / Integral	7/16" (1.11 cm)
2565 ©	2565	RN 3-7/8	11-3/8" x 5-1/4" x 3-9/16" (28.89 x 13.34 x 9.05 cm)	Lid: 15/16" (2.38 cm) Base: 2-5/8" (6.67 cm)	12-1/4" x 6-1/4" x 3-7/8" (31.12 x 15.88 x 9.84 cm)	H001 / Integral	7/16" (1.11 cm)
2574 ©	2574	RQ 1-3/4	11-3/8" x 7.0" x 1-7/16" (28.89 x 17.78 x 3.65 cm)	Lid: 5/8" (1.59 cm) Base: 13/16" (2.06 cm)	12-1/4" x 8.0" x 1-3/4" (31.12 x 20.32 x 4.45 cm)	None / Integral	7/16" (1.11 cm)
2581 ©	2581	RQ 2-1/16	11-3/8" x 7.0" x 1-3/4" (28.89 x 17.78 x 4.45 cm)	Lid: 5/8" (1.59 cm) Base: 1-1/8" (2.86 cm)	12-1/4" x 8.0" x 2-1/16" (31.12 x 20.32 x 5.24 cm)	None / Integral	7/16" (1.11 cm)
2575 ©	2575	RQ 2-3/8	11-3/8" x 7.0" x 2-1/16" (28.89 x 17.78 x 5.24 cm)	Lid: 1.0" (2.54 cm) Base: 1-1/8" (2.86 cm)	12-1/4" x 8.0" x 2-3/8" (31.12 x 20.32 x 6.03 cm)	None / Integral	7/16" (1.11 cm)
7144 ©	7144	RQ 2-3/4	11-3/8" x 7.0" x 2-3/8" (28.89 x 17.78 x 6.03 cm)	Lid: 1-1/4" (3.18 cm) Base: 1-1/8" (2.86 cm)	12-1/4" x 8.0" x 2-3/4" (31.12 x 20.32 x 6.99 cm)	None / Integral	7/16" (1.11 cm)
2577 ©	2577	RQ 3-1/8	11-3/8" x 7.0" x 2-13/16" (28.89 x 17.78 x 7.14 cm)	Lid: 5/8" (1.59 cm) Base: 2-3/16" (5.56 cm)	12-1/4" x 8.0" x 3-1/8" (31.12 x 20.32 x 7.94 cm)	H052 / Integral	7/16" (1.11 cm)
2579 ©	2579	RQ 3-1/8	11-3/8" x 7.0" x 3-9/16" (28.89 x 17.78 x 9.05 cm)	Lid: 1.0" (2.54 cm) Base: 2-5/8" (6.67 cm)	12-1/4" x 8.0" x 3-7/8" (31.12 x 20.32 x 9.84 cm)	H001 / Integral	7/16" (1.11 cm)
2585 ©	2585	RQ 4-1/4	11-3/8" x 7.0" x 3-7/8" (28.89 x 17.78 x 9.84 cm)	Lid: 1-1/4" (3.18 cm) Base: 2-5/8" (6.67 cm)	12-1/4" x 8.0" x 4-1/4" (31.12 x 20.32 x 10.80 cm)	H001 / Integral	7/16" (1.11 cm)

Cases: "R" Series Case Continued

MODEL #	STOCK #	DESCRIPTION	DIMENS. (INSIDE: L x W x D) (D X E X F)	INSIDE DEPTH (INSIDE: LID, BASE)	DIMENS. (OUTSIDE: L x W x D) (A x B x C)	STANDARD: HANDLE / LATCH	ROUTED DEPTH = I
2588 ©	2588	RT 1-3/4	11-5/8" x 3-1/4" x 1-7/16" (29.53 x 8.26 x 3.65 cm)	Lid: 5/8" (1.59 cm) Base: 13/16" (2.06 cm)	12-1/2" x 4-1/4" x 1-3/4" (31.75 x 10.80 x 4.45 cm)	None / Integral	7/16" (1.11 cm)
2590 ©	2590	RT 3-1/8	11-5/8" x 3-1/4" x 2-13/16" (29.53 x 8.26 x 7.14 cm)	Lid: 5/8" (1.59 cm) Base: 2-3/16" (5.56 cm)	12-1/2" x 4-1/4" x 3-1/8" (31.75 x 10.80 x 7.94 cm)	None / Integral	7/16" (1.11 cm)
2618 ©	2618	RV 2-1/16	12-11/16" x 8-15/16" x 1-3/4" (32.23 x 22.70 x 4.45 cm)	Lid: 5/8" (1.59 cm) Base: 1-1/8" (2.86 cm)	13-1/2" x 10.0" x 2-1/16" (34.29 x 25.40 x 5.24 cm)	None / Integral	7/16" (1.11 cm)
2596 ©	2596	RV 2-3/8	12-11/16" x 8-15/16" x 2-1/16" (32.23 x 22.70 x 5.24 cm)	Lid: 1.0" (2.54 cm) Base: 1-1/8" (2.86 cm)	13-1/2" x 10.0" x 2-3/8" (34.29 x 25.40 x 6.03 cm)	None / Integral	7/16" (1.11 cm)
2597 ©	2597	RV 3-1/8	12-11/16" x 8-15/16" x 2-13/16" (32.23 x 22.70 x 7.14 cm)	Lid: 5/8" (1.59 cm) Base: 2-3/16" (5.56 cm)	13-1/2" x 10.0" x 3-1/8" (34.29 x 25.40 x 7.94 cm)	None / Integral	7/16" (1.11 cm)
2611 ©	2611	RV 3-7/16	12-11/16" x 8-15/16" x 2-13/16" (32.23 x 22.70 x 7.14 cm)	Lid: 5/8" (1.59 cm) Base: 2-13/16" (7.14 cm)	13-1/2" x 10.0" x 3-7/16" (34.29 x 25.40 x 8.73 cm)	H024 / Integral	7/16" (1.11 cm)
2600 ©	2600	RV 4	12-11/16" x 8-15/16" x 3-11/16" (32.23 x 22.70 x 9.67 cm)	Lid: 1.0" (2.54 cm) Base: 2-3/4" (6.99 cm)	13-1/2" x 10.0" x 4.0" (34.29 x 25.40 x 10.16 cm)	H052 / Integral	7/16" (1.11 cm)
2605 ©	2605	RV 5-1/8	12-11/16" x 8-15/16" x 4-3/4" (32.23 x 22.70 x 12.07 cm)	Lid: 1-1/2" (3.81 cm) Base: 3-1/4" (8.26 cm)	13-1/2" x 10.0" x 5-1/8" (34.29 x 25.40 x 13.02 cm)	H024 / Integral	7/16" (1.11 cm)
2619 ©	2619	RV 6-1/8	12-11/16" x 8-15/16" x 5-5/8" (32.23 x 22.70 x 14.29 cm)	Lid: 1-7/8" (4.76 cm) Base: 3-3/4" (9.53 cm)	13-1/2" x 10.0" x 6-1/8" (34.29 x 25.40 x 15.56 cm)	H024 / Integral	7/16" (1.11 cm)
7205 ©	7205	RW 4-3/4 Opt. Integral Handle	14.0" x 10-3/4" x 4-1/4" (35.56 x 27.31 x 10.80 cm)	Lid: 1-3/8" (3.49 cm) Base: 2-7/8" (7.30 cm)	15-1/2" x 12-1/4" x 4-3/4" (39.37 x 31.12 x 12.07 cm)	H023OM / Integral	1-1/4" (3.18 cm)
7279 ©	7279	RW 5-1/2 Opt. Integral Handle	14.0" x 10-3/4" x 5.0" (35.56 x 27.31 x 12.70 cm)	Lid: 2-1/8" (5.40 cm) Base: 2-7/8" (7.30 cm)	15-1/2" x 12-1/4" x 5-1/2" (39.37 x 31.12 x 13.97 cm)	H023OM / Integral	1-1/4" (3.18 cm)
7207 ©	7207	RW 5-1/2 Opt. Integral Handle	14.0" x 10-3/4" x 5.0" (35.56 x 27.31 x 12.70 cm)	Lid: 1-3/8" (3.49 cm) Base: 3-5/8" (9.21 cm)	15-1/2" x 12-1/4" x 5-1/2" (39.37 x 31.12 x 13.97 cm)	H023OM / Integral	1-1/4" (3.18 cm)
7203 ©	7203	RW 6-1/4 Opt. Integral Handle	14.0" x 10-3/4" x 5-3/4" (35.56 x 27.31 x 14.61 cm)	Lid: 2-1/8" (5.40 cm) Base: 3-5/8" (9.21 cm)	15-1/2" x 12-1/4" x 6-1/4" (39.37 x 31.12 x 15.88 cm)	H023OM / Integral	1-1/4" (3.18 cm)
14532 ©	14532	RX 3 Opt. Integral Handle	17.0" x 13.0" x 2-1/2" (43.18 x 33.02 x 6.35 cm)	Lid: 7/8" (2.22 cm) Base: 1-5/8" (4.13 cm)	18-1/2" x 14-1/2" x 3.0" (46.99 x 36.83 x 7.62 cm)	H023OM / Integral	15/16" (2.38 cm)
2725 ©	2725	RX 5 Opt. Integral Handle	17.0" x 13.0" x 4-1/2" (43.18 x 33.02 x 11.43 cm)	Lid: 1-3/8" (3.49 cm) Base: 3-1/8" (7.94 cm)	18-1/2" x 14-1/2" x 5.0" (46.99 x 36.83 x 12.70 cm)	H023OM / Integral	15/16" (2.38 cm)
2728 ©	2728	RX 6-1/4 Opt. Integral Handle	17.0" x 13.0" x 5-5/8" (43.18 x 33.02 x 14.29 cm)	Lid: 1-3/4" (4.45 cm) Base: 3-7/8" (9.84 cm)	18-1/2" x 14-1/2" x 6-1/4" (46.99 x 36.83 x 15.88 cm)	H023OM / Integral	15/16" (2.38 cm)
2742 ©	2742	RX 8 Opt. Integral Handle	17.0" x 13.0" x 7-3/8" (43.18 x 33.02 x 18.73 cm)	Lid: 3-1/2" (8.89 cm) Base: 3-7/8" (9.84 cm)	18-1/2" x 14-1/2" x 8.0" (46.99 x 36.83 x 20.32 cm)	H023OM / L037	15/16" (2.38 cm)



For Customer Service Inquiries Call: 1(800) 344-5716



Cases: The Aegis Line New!

The Aegis Line is Flambeau's newest blow molded family featuring a new, rugged design with thick double walls, snap - fit latches, locking points for extra security, steel pin hinge construction and an integral handle for easy carry. Available in seven unique sizes from one of the smallest blow molded cases to one of the largest on the market today. The Aegis Line can be customized with a hot stamp, engraved logo plate, custom molded interiors, foam inserts, custom latches and/or color. Stackable and stands on 2 feet, these cases can handle any tough job!

- Plastic latches available for stock cases
- Metal latches available for minimum order quantities



Customize Cases with
Your name/company here



Aegis 7



Aegis 12

Shown with an optional custom interior



Aegis 13



Aegis 15

All cases stocked with open core interiors

MODEL #	STOCK #	DESCRIPTION	DIMENSIONS (INSIDE: L x W x D)	DIMENSIONS (OUTSIDE: L x W x D)	PACKED
51000	51000	Aegis 7 1 Locking Point	6-2/5" x 3-1/2" x 1-3/4" (16.15 x 9.04 x 4.37 cm)	7-3/5" x 5-1/4" x 2-1/2" (19.38 x 13.39 x 6.35 cm)	105/ctn
51200	51200	Aegis 12 No Locking Points	10-1/3" x 7-7/8" x 2-3/4" (26.19 x 19.91 x 5.74 cm)	11-3/4" x 10-2/5" x 2-7/8" (29.85 x 26.39 x 7.29 cm)	10/ctn
51250	51250	Aegis 13 2 Locking Points	12-1/8" x 6-3/5" x 2-1/2" (30.68 x 16.71 x 6.35 cm)	14-1/16" x 10.0" x 3-2/5" (35.71 x 25.43 x 8.66 cm)	30/ctn
51400	51400	Aegis 15 2 Locking Points	13-1/2" x 12.0" x 3-1/8" (34.14 x 30.23 x 7.82 cm)	16.0" x 15-1/2" x 4-1/3" (40.49 x 39.50 x 10.95 cm)	12/ctn



Aegis 22



One of the largest blow molded cases in the market today! (Shown holding respirator equipment)

Aegis 29



Aegis 23

MODEL #	STOCK #	DESCRIPTION	DIMENSIONS (INSIDE: L x W x D)	DIMENSIONS (OUTSIDE: L x W x D)	PACKED
51550	51550	Aegis 22 2 Locking Points	19-3/5" x 15-1/3" x 4-2/5" (49.68 x 39.0 x 11.13 cm)	22-1/2" x 19-3/5" x 5-3/5" (56.90 x 49.71 x 14.12 cm)	4/ctn
51700	51700	Aegis 23 2 Locking Points	20.0" x 7-7/8" x 2-3/5" (50.62 x 19.84 x 6.71 cm)	22-1/2" x 11.0" x 3-1/2" (57.15 x 27.94 x 8.89 cm)	13/ctn
51900	51900	Aegis 29 2 Locking Points, Optional 2 Additional Latches	25.0" x 13-1/2" x 12-4/5" (63.5 x 34.29 x 32.39 cm)	29.0" x 21-1/8" x 13-3/4" (73.66 x 53.57 x 34.93 cm)	1/ctn



For Customer Service Inquiries Call: 1(800) 344-5716



Cases: Parts & Accessories - Case Handles & Latches

Please Note: Some cases do not have options available, please see each case family (pages 59-71) for details.

Infinity Cases: (Reference Info on pages 61 - 62)



Handle - H052
Styles: FH, FQ (4-1/2 only) & FV



Over Mold Grip Handle - H0230M
Styles: FH, FQ, FV, FW, FX & FZ



Handle - H074
Style: FZ



Handle - H023
Styles: FW & FX



Latch - L085
Style: FW



Latch - L115
Style: FZ (8-1/2)



Latch - L089
Styles: FH, FQ & FV



Latch - L095
Style: FX



Latch - L116
Style: FZ (7)

"P" Series (Reference Info on pages 63-65)



Handle - H001
Styles: PC, PF (3-1/8 only), PH



Handle - H052
Styles: PQ (3-7/16, 3-13/16 & 3-7/8 only), PV



Handle - H023
Styles: PW (4, 4-3/4, 5-1/2 & 6-1/4 only), PX (8 only), PZ



Handle - Integral
Styles: PW, PX & PZ



Latch - L089
Styles: PB, PC, PF, PH, PQ, PV



Latch - L085
Styles: PW (4, 4-3/4, 5-1/2 & 6-1/4 only), PX (8 only)



Latch - L026
Styles: PW (6-1/4 only)
PX (5 & 8 only)



Latch - L037
Styles: PX (3-1/2, 5, 6-1/4 & 8 only)



Latch - L095
Use with Style: PZ

"R" Series (Reference Info on pages 66-69)



Handle - H001
Styles: RA (3-1/8 & 3-7/16 only),
RC (3-7/8 only), RF (3-1/8 only),
RH (3-1/8, 3-7/16 & 3-7/8 only),
RK (3-1/8 & 3-9/16 only),
RN (3-7/16 & 3-7/8 only)
& RQ (3-7/8 & 4-1/4 only)



Handle - H024
Style: RV (3-7/16, 5-1/8 & 6-1/8 only)



Handle - H023
Styles: RW, RX



Latch - Integral Styles: RA, RB, RC, RF,
RH, RK, RN, RQ, RT, RV, RW, & RX
(3, 5 & 6-1/4 only)



Latch - L037
Style: RX (8 only)

Cases: Parts & Accessories - Case Handles & Latches (Continued)

Optional Handles & Latches



Handle - Integral
P Series Styles: PW, PX & PZ
R Series Styles: RW & RX

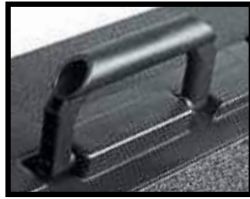

Handle - H074
Gear Box & Custom Case
Applications Only



Handle - H040
Custom Case Applications
Only



Infinity Metal Latch - L078
Styles FW, FX & Custom Case
Applications



Latch - L115
Custom Case Applications Only



Latch - L0110
Custom Case Applications
Only

Display Windows

The windows are manufactured from a clear plastic resin and can be hot stamped with your company name or logo. Four sizes of windows are available and are custom fitted to our pin hinge style cases.



AR1466 (L x W)
7-1/2" x 3-1/2" (19.05 x 8.89 cm)



AR1536 (L x W)
10-1/4" x 3.0" (26.04 x 7.62 cm)



X-1191 Small (L x W)
5-15/16" x 1-15/16" (15.08 x 4.92 cm)



X-1193 Large (L x W)
8-7/16" x 2-3/16" (21.43 x 5.56 cm)

Additional Options



Flambeau Purge Valve



Perimeter Gasket



**Custom Small & Large Exterior
Logo Plate**
Additional Tooling Expense



Lid Stays



Interior Door(s)
Additional Tooling Expense



Interior Tray(s)
Additional Tooling Expense



Security Feature



Removable Lid



**Literature Holder
Routed Slot**



**Literature Holder Plastic Clip
- X893**



**Literature Holder
Elastic Strap**



**Pallets and/or File
Folders**

For information on Flambeau's Custom Capabilities see the Custom Capabilities Section starting on page 2.



For Customer Service Inquiries Call: 1(800) 344-5716



Cases: Black Ribbon™

Flambeau offers a product line of water resistant cases available in six sizes! These extremely durable cases feature a metal front cam locking mechanical latch system & external rubber bumpers for impact absorption, skid resistance, and greater durability. Made of tough, impact-resistant ABS plastic, these cases are available with or without foam, as well as die-cut foam should you require more protection for your valuables. Black Ribbon cases are excellent for outdoor use in demanding environments and are ideal for storing and protecting cell phones, electronic devices, jewelry, small tools, components and more!



Customizable Case to Protect Your Valuables!



6739PB



Customize Cases with
Your name/company here



6734PF
4-3/8"



6736PF
6-1/4"



6737PF
7-3/4"

MODEL #	STOCK #	DESCRIPTION	DIMENS. (INSIDE: L x W x D)	PACKED	MODEL #	STOCK #	DESCRIPTION	DIMENS. (INSIDE: L x W x D)	PACKED
6734PC	6734PC	4-3/8" (11.11 cm) Black - w/Out Foam	3-7/8" x 2-3/8" x 1-3/8" (9.84 x 6.03 x 3.49 cm)	4/ctn	6734PF	6734PF	4-3/8" (11.11 cm) Black - w/Flat Foam Lid & Base	3-7/8" x 2-3/8" x 1-3/8" (9.84 x 6.03 x 3.49 cm)	4/ctn
6735PC	6735PC	5.0" (12.70 cm) Black - w/Out Foam	4-3/8" x 2-7/8" x 1-3/8" (11.11 x 7.30 x 3.49 cm)	4/ctn	6735PF	6735PF	5.0" (12.70 cm) Black - w/Flat Foam Lid & Base	4-3/8" x 2-7/8" x 1-3/8" (11.11 x 7.30 x 3.49 cm)	4/ctn
6736PC	6736PC	6-1/4" (15.56 cm) Black - w/Out Foam	5-7/8" x 2-3/4" x 1-1/2" (14.92 x 6.99 x 3.81 cm)	4/ctn	6736PF	6736PF	6-1/4" (15.56 cm) Black - w/Flat Foam Lid & Base	5-7/8" x 2-3/4" x 1-1/2" (14.92 x 6.99 x 3.81 cm)	4/ctn
6737PC	6737PC	7-3/4" (19.69 cm) Black - w/Out Foam	7-1/8" x 3-5/8" x 1-11/16" (18.10 x 9.21 x 4.29 cm)	4/ctn	6737PF	6737PF	7-3/4" (19.69 cm) Black - w/Flat Foam Lid & Base	7-1/8" x 3-5/8" x 1-11/16" (18.10 x 9.21 x 4.29 cm)	4/ctn
6738PC	6738PC	8-1/2" (21.59 cm) Black - w/Out Foam	8-1/2" x 5-1/4" x 2-1/4" (21.59 x 13.34 x 5.72 cm)	4/ctn	6739PB	6739PB	10-3/5" (26.92 cm) Black - w/Out Foam	10.0" x 8.0" x 2-1/2" (25.40 x 20.32 x 6.35 cm)	4/ctn

Cases: Secure-Lock™ Case

Secure-Lock™ is a heavy-duty plastic carrying case with patented locking features designed to safely store and help secure personal valuables. Two of the three configurations feature a “cam-actuated” locking mechanism which locks the case down—while the contents inside remain locked.

Features:

- Steel hinge pin construction
- Tamper resistant hinge segments
- Patented “Lockdown” features (models 6615LB & 6620LB)
- Includes 2 keys



Short Axle Lockdown Feature



Tall Axle Lockdown Feature

Patent # 8,695,386

MODEL #	STOCK #	DESCRIPTION	DIMENS. (INSIDE: L x W x D)	PACKED
6610LB	6610LB	Black, Open Core w/Out Lockdown Feature	8-1/2" x 7-1/8" x 2-3/4" (21.59 x 18.10 x 6.99 cm)	12/ctn
6615LB	6615LB	Black, Open Core w/Lockdown Feature	8-1/2" x 7-1/8" x 2-3/4" (21.59 x 18.10 x 6.99 cm)	12/ctn
6620LB®	6620LB	Black, Divided Core w/Lockdown Feature	8-1/2" x 7-1/8" x 2-3/4" (21.59 x 18.10 x 6.99 cm)	12/ctn



For Customer Service Inquiries Call: 1(800) 344-5716



Cases: Vision 20™ New!

The Vision 20, combines blow mold and injection mold technologies resulting in an innovative solution for packaging and merchandising! The Vision 20 base is made with double wall blow mold construction. The lid is manufactured with an “ultra-clear” injection mold terpolymer resin. The result is a startling efficient carrying case offering limitless customized options with window-like clarity for interior viewing!

Features:

- Window-like clarity:
 - **(50900)** Lid made of Terpolymer
 - **(50901)** Lid made of Polypropylene
- Double wall construction in base
- Convenient carrying handle
- 2 Locking points
- Sturdy snap-shut latches
- Customizable interior



Ability to see your valuables inside!



50900
“Window-like view!”



50901

MODEL #	STOCK #	DESCRIPTION	DIMENS. (INSIDE: L x W x D)	PACKED
50900	50900	Black with Clear Terpolymer Lid	17-3/4" x 12-3/4" x 5-1/2" (45.09 x 32.39 x 13.99 cm)	1/ctn
50901	50901	Black with Clear Polypropylene Lid	17-3/4" x 12-3/4" x 5-1/2" (45.09 x 32.39 x 13.99 cm)	1/ctn

Cases: 4" x 6", 6" x 6" and 12" x 12" Boxes New!

Made out of translucent clear, acid-free polypropylene, the 4x6, 6x6, 12x12, with and without a handle, cases are ideal for displaying product or quick reference of the contents inside. This case also features durable back hinges & an integrated, positive locking latch to help secure contents.

With a wide-open concept, these boxes are suitable for various applications. Easily customize with your company's logo for that finished look!

4 x 6 Box



6764TE

6 x 6 Box

Great for first-aid supplies



6766TE

12 x 12 Box W/Out Handle



6762TE

12 x 12 Box With Handle



6763TE

With handle

Cases: Strip Case 24" x 4" Box New!

Almost two feet long with seven adjustable compartments, the unique Strip Case allows extra room for contents to be stored with a clear view of what's inside! Capable of storing rods, screw drivers, rulers and crossbow arrows, this case features two locking points for extra security and sturdy mechanical latches.



Can be used as a Crossbow Bolt case . . .



Includes Removable "B" * Dividers

. . . or a Tool Kit!

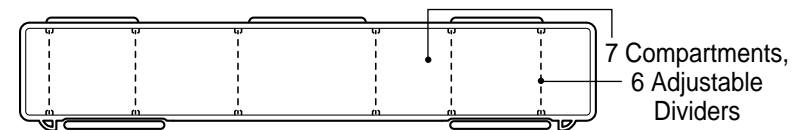

7 Compartments, 6 Adjustable Dividers



Optional Fabric Clip Dividers Available

*Dividers come in a pack of 12 with (8) A's and (4) B's. Only the B's properly fit. Please discard the A's or ask customer service for additional "B" dividers.

MODEL #	STOCK #	DESCRIPTION	DIMENS. (INSIDE: L x W x D)	PACKED
6764TE	6764TE	4 x 6, Clear	6-5/8" x 4-3/4" x 1-1/8" (16.82 x 12.06 x 2.85 cm)	12/ctn
6766TE	6766TE	6 x 6, Clear	6-1/4" x 6-1/4" x 2-1/8" (15.88 x 15.88 x 5.40 cm)	6/ctn
6762TE	6762TE	12 x 12, Clear W/Out Handle	14-1/8" x 13-5/8" x 3.0" (35.87 x 34.60 x 7.62 cm)	3/ctn
6763TE	6763TE	12 x 12, Clear With Handle	14-1/8" x 13-5/8" x 3.0" (35.87 x 34.60 x 7.62 cm)	3/ctn
6769TE	6769TE	Strip Case, Clear with Mechanical Latches	23.0" x 3-1/4" x 3-1/5" (58.42 x 8.25 x 8.05 cm)	6/ctn



For Customer Service Inquiries Call: 1(800) 344-5716



Cases: Blow Molded Mailers

Reusable shipping containers from Flambeau will help you save money and give you the durability needed to protect your cargo while in transit. Our blow molded mailers feature double-wall construction and are stackable. Offered with our standard convoluted foam, they are designed to protect even the most sensitive cargo. Lids and bases are separate pieces for loading convenience and feature overlapping positive edges to reduce lid movement and provide a natural dust barrier. Lids and bases must be secured for transit. Made of high-density polyethylene (HDPE) our mailers are impervious to most common chemicals and gasoline.

Features:

- Double-Wall Construction
- Impervious to Most Common Chemicals & Gasoline
- Crush-Resistant and Stackable

Mailer with
Convoluted Foam



8162-PI14

8792-PI04

8793-PI06

8794-PI06

8286-PI07

8161-PI19

10133-PI20

* Express Service (E Symbol) items are for quantities 500 and less.
For greater quantities call customer service: 1-800-344-5716.

MODEL #	STOCK #	DIMENSIONS (OUTSIDE: L x W x D)	DIMENSIONS (INSIDE: L x W x D)	MAXIMUM LOAD SIZE: (L x W x D)	PACKED
8792-PI04 [Ⓢ]	8792-PI04	12.0" x 10.0" x 3.0" (30.48 x 25.40 x 7.62 cm)	9-1/2" x 7.0" x 1-5/8" (24.13 x 17.78 x 4.13 cm)	8-1/2" x 6.0" x 1.0" (21.59 x 15.24 x 2.54 cm)	32/ctn
8793-PI05 ^E	8793-PI05	12.0" x 10.0" x 5.0" (30.48 x 25.40 x 12.70 cm)	9-1/2" x 7.0" x 4.0" (24.13 x 17.78 x 10.16 cm)	8-1/2" x 6.0" x 3-1/4" (21.59 x 15.24 x 8.26 cm)	32/ctn
8794-PI06 [Ⓢ]	8794-PI06	14.0" x 12.0" x 3.0" (35.56 x 30.48 x 7.62 cm)	11-1/2" x 9.0" x 1-5/8" (29.21 x 22.86 x 4.13 cm)	10-1/2" x 8.0" x 1.0" (26.67 x 20.32 x 2.54 cm)	32/ctn
8286-PI07 ^E	8286-PI06	14.0" x 12.0" x 5.0" (35.56 x 30.48 x 12.70 cm)	11-1/2" x 9.0" x 4.0" (29.21 x 22.86 x 10.16 cm)	10-1/2" x 8.0" x 3-1/4" (26.67 x 20.32 x 8.26 cm)	32/ctn
8161-PI19 ^E	8161-PI19	21.0" x 15.0" x 5.0" (53.34 x 38.10 x 12.70 cm)	18.0" x 12.0" x 4.0" (45.72 x 30.48 x 10.16 cm)	17.0" x 11.0" x 2-1/2" (43.18 x 27.94 x 6.35 cm)	6/ctn
10133-PI20 [Ⓢ]	10133-PI20	27.0" x 14-1/2" x 7.0" (68.58 x 36.83 x 17.78 cm)	24.0" x 12.0" x 6.0" (60.96 x 30.48 x 15.24 cm)	23.0" x 11.0" x 2-5/8" (58.42 x 27.94 x 6.67 cm)	3/ctn

Cases: Blow Molded Tradesman™ Case

Featuring extra thick wall construction, the Blow Molded Tradesman is one of our most durable cases. This high-density polyethylene (HDPE) case is resistant to most common chemicals, gasoline and the harshest conditions. The sleek design includes an integral handle, hinge and latch system.

Features:

- Extra Thick Wall Construction
- Logo Area for Customization
- Impervious to Most Common Chemicals & Gasoline



MODEL #	STOCK #	DESCRIPTION	DIMENSIONS (INSIDE: L x W x D)	PACKED
819116	19978	Black Double-Wall Case w/Logo Plate Area	15.0" x 8-1/2" x 3-1/2" (38.10 x 21.59 x 8.89 cm)	16/ctn

Cases: Beta Case

Durability is built into this case! Made of high-density polyethylene (HDPE), this case is impervious to most common chemicals. Featuring an integral handle, hinge and latch system, the Beta Case is built tough.

Features:

- Integral Handle, Hinge & Latch System
- Impervious to Most Common Chemicals & Gasoline

* Express Service (E Symbol) items are for quantities 500 and less.
For greater quantities call customer service: 1-800-344-5716.



MODEL #	STOCK #	DESCRIPTION	DIMENSIONS (INSIDE: L x W x D)	INSIDE DEPTH (INSIDE: LID, BASE)	PACKED
21496	21496	Black, Double-Wall Case	13.0" x 8-1/2" x 2-3/4" (33.02 x 21.59 x 6.99 cm)	Lid: 1-1/2" (3.81 cm) Base: 1-1/2" (3.81 cm)	16/ctn
50237	50237	Black, Double-Wall Case w/Small Logo Plate	13.0" x 8-1/2" x 2-3/4" (33.02 x 21.59 x 6.99 cm)	Lid: 1-1/2" (3.81 cm) Base: 1-1/2" (3.81 cm)	16/ctn



For Customer Service Inquiries Call: 1(800) 344-5716



Satchel Boxes: Deep & Slim Super Satchels™

Used in many industries as a kit for replacement parts or as a salesperson's sidekick, you won't need to worry about being organized. All Super Satchels are made out of "Acid Free" translucent polypropylene, with a positive contact latch system. The Deep Super Satchels are available in one compartment, six

fixed compartments or six fixed compartments with removable dividers. The Slim Super Satchels are available in one compartment or eight fixed compartments and can accommodate up to 40 removable dividers.

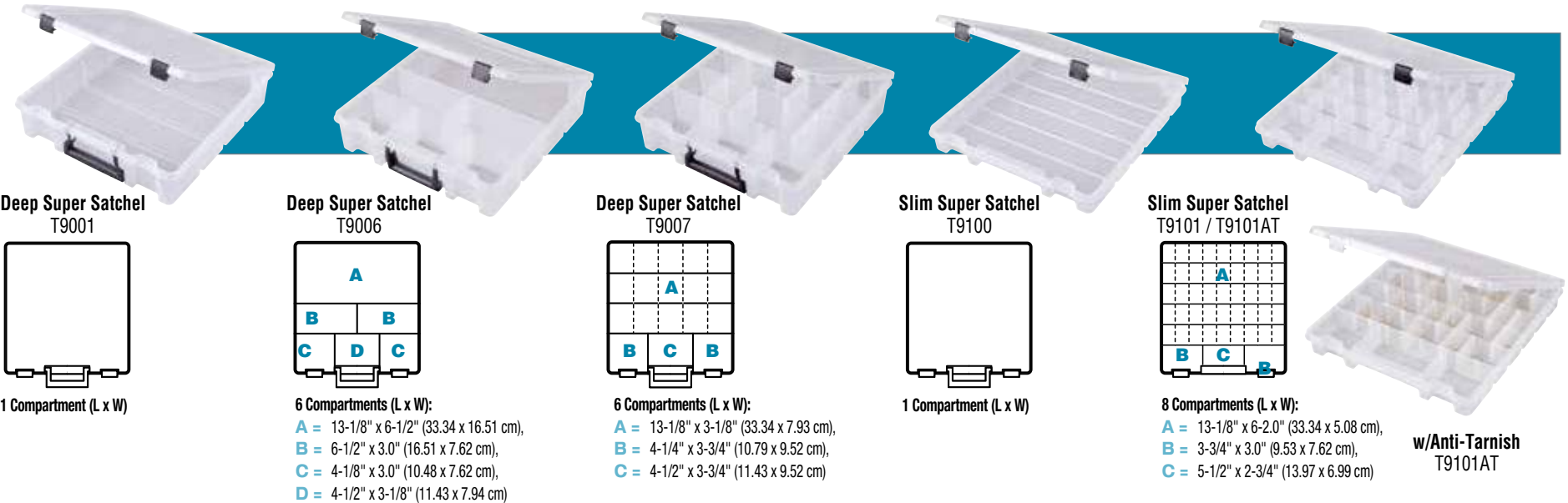

Deep Super Satchel
T9001

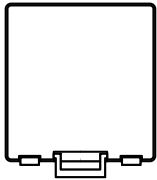

1 Compartment (L x W)

Deep Super Satchel
T9006

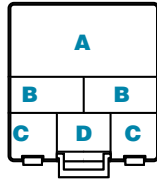

6 Compartments (L x W):

- A = 13-1/8" x 6-1/2" (33.34 x 16.51 cm),
- B = 6-1/2" x 3.0" (16.51 x 7.62 cm),
- C = 4-1/8" x 3.0" (10.48 x 7.62 cm),
- D = 4-1/2" x 3-1/8" (11.43 x 7.94 cm)

Deep Super Satchel
T9007

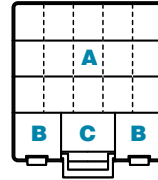

6 Compartments (L x W):

- A = 13-1/8" x 3-1/8" (33.34 x 7.93 cm),
- B = 4-1/4" x 3-3/4" (10.79 x 9.52 cm),
- C = 4-1/2" x 3-3/4" (11.43 x 9.52 cm)

Slim Super Satchel
T9100

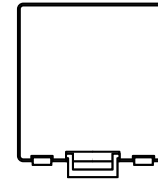

1 Compartment (L x W)

Slim Super Satchel
T9101 / T9101AT

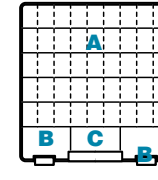

8 Compartments (L x W):

- A = 13-1/8" x 6-2.0" (33.34 x 5.08 cm),
- B = 3-3/4" x 3.0" (9.53 x 7.62 cm),
- C = 5-1/2" x 2-3/4" (13.97 x 6.99 cm)

w/Anti-Tarnish
T9101AT

MODEL #	STOCK #	DESCRIPTION	DIMENS. (INSIDE: L x W x D)	DIMENSIONS (OUTSIDE: L x W x D)	PACKED
T9001	6991TE	1 Compartment w/Black Handle & Latches	13-1/8" x 13-1/8" x 3.0" (33.34 x 33.34 x 7.62 cm)	14.0" x 15.0" x 3-1/2" (35.56 x 38.10 x 8.89 cm)	6/ctn
T9006	6996TE	6 Compartments w/Black Handle & Latches	13-1/8" x 13-1/8" x 3.0" (33.34 x 33.34 x 7.62 cm)	14.0" x 15.0" x 3-1/2" (35.56 x 38.10 x 8.89 cm)	6/ctn
T9007	6997TE	6 Compts w/Black Handle & Latches & 12 Removable Dividers*	13-1/8" x 13-1/8" x 3.0" (33.34 x 33.34 x 7.62 cm)	14.0" x 15.0" x 3-1/2" (35.56 x 38.10 x 8.89 cm)	6/ctn
T9100	6990TE	1 Compartment w/Black Handle & Latches	13-1/8" x 13-1/8" x 1-3/4" (33.34 x 33.34 x 4.45 cm)	14.0" x 15.0" x 2.0" (35.56 x 38.10 x 5.08 cm)	6/ctn
T9101	6998TE	8 Compts w/Black Handle & Latches & 20 Removable Dividers*	13-1/8" x 13-1/8" x 1-3/4" (33.34 x 33.34 x 4.45 cm)	14.0" x 15.0" x 2.0" (35.56 x 38.10 x 5.08 cm)	6/ctn
T9101AT	6999TE	8 Compts w/Silver Handle & Latches & 20 Removable Anti-Tarnish Dividers*	13-1/8" x 13-1/8" x 1-3/4" (33.34 x 33.34 x 4.45 cm)	14.0" x 15.0" x 2.0" (35.56 x 38.10 x 5.08 cm)	6/ctn

*Please Note: additional divider packs sold separately on (page 5)

Satchel Boxes: Deluxe Super Satchels™

Like the Deep and Slim Super Satchels, the Deluxe Super Satchels are made out of "Acid Free" translucent polypropylene, with a positive contact latch system.



Up to (24) Compartments

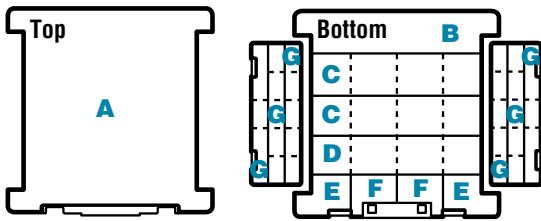

T9500 Deluxe Super Satchel (L x W):

- A** = 13-1/4" x 15-1/8" (33.66 x 38.42 cm),
- B** = 13-1/2" x 3-1/8" (34.29 x 7.94 cm),
- C** = (2 rows of 4 compts) 2-7/8" x 3-1/8" (7.30 x 7.94 cm),
- D** = (1 rows of 4 compts) 2-7/8" x 3-1/4" (7.30 x 8.26 cm)
- E** = (2 compts) 3.0" x 2-1/2" (7.62 x 6.35 cm),
- F** = (2 compts) 2-1/4" x 3-5/8" (5.72 x 9.21 cm),
- G** = (3 rows of 15 compts/each side) 2-1/4" x 1-1/8" (5.71 x 2.86 cm)

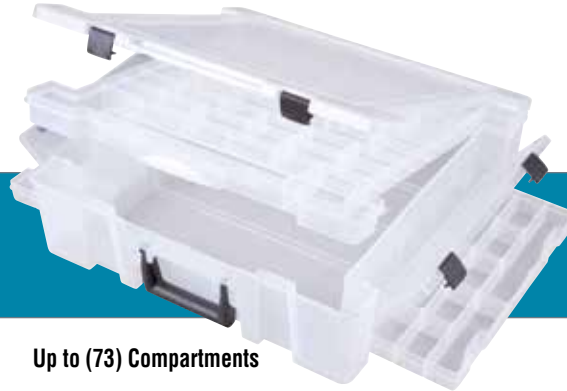

Up to (73) Compartments

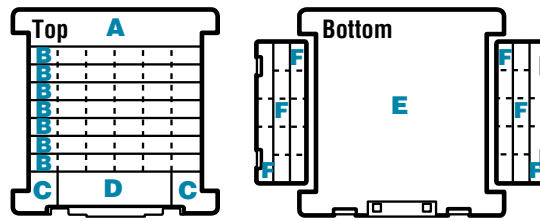

T9501 Deluxe Super Satchel (L x W):

- A** = 13-1/4" x 2-3/4" (33.66 x 6.99 cm),
- B** = (7 rows of 42 compts) 13-1/4" x 1-1/4" (33.66 x 3.18 cm),
- C** = (2 compts) 2.0" x 2-5/8" (5.08 x 6.67 cm),
- D** = (1 compts) 9.0" x 2-3/4" (22.86 x 6.99 cm)
- E** = 13-1/4" x 5-1/2" (33.66 x 38.74 cm),
- F** = (3 rows of 15 compts/each side) 2-1/4" x 1-1/8" (5.71 x 2.86 cm)



Up to (89) Compartments

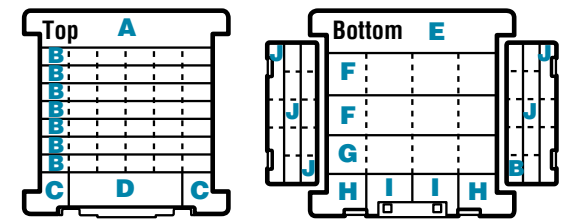

T9502 Deluxe Super Satchel (L x W):

- A** = 13-1/4" x 2-3/4" (33.66 x 6.99 cm),
- B** = 13-1/4" x 1-1/4" (33.66 x 3.18 cm),
- C** = 2.0" x 2-5/8" (5.08 x 6.67 cm),
- D** = 9.0" x 2-3/4" (22.86 x 6.99 cm)
- E** = 13-1/2" x 3-1/8" (34.29 x 7.94 cm),
- F** = (2 rows of 4 compts) 2-7/8" x 3-1/8" (7.30 x 7.94 cm),
- G** = (1 row of 4 compts) 2-7/8" x 3-1/4" (7.30 x 8.26 cm),
- H** = (2 compts) 3.0" x 2-1/2" (7.62 x 6.35 cm),
- I** = (2 compts) 2-1/4" x 3-5/8" (5.72 x 9.21 cm),
- J** = (3 rows of 15 compts/each side) 2-1/4" x 1-1/8" (5.71 x 2.86 cm)

MODEL #	STOCK #	DESCRIPTION	DIMENSIONS (OUTSIDE: L x W x D)	PACKED
T9500	6787TE	Translucent w/Black Handle & Latches Open Top / Divided Bottom, Includes Removable Dividers*	17-1/4" x 16-3/4" x 5.0" (43.82 x 42.55 x 12.70 cm)	3/ctn
T9501	6788TE	Translucent w/Black Handle & Latches Divided Top / Open Bottom, Includes Removable Dividers*	17-1/4" x 16-3/4" x 5.0" (43.82 x 42.55 x 12.70 cm)	3/ctn
T9502	6789TE	Translucent w/Black Handle & Latches Divided Top / Divided Bottom, Includes Removable Dividers*	17-1/4" x 16-3/4" x 5.0" (43.82 x 42.55 x 12.70 cm)	3/ctn

***Please Note:**
additional divider packs
sold separately on (page 5)



For Customer Service Inquiries Call: 1(800) 344-5716



Satchel Boxes: Double Deep Super Satchel™



Like the Deep and Slim Super Satchels, the Double Deep Super Satchels are made out of "Acid Free" translucent polypropylene, with a positive contact latch system.

MODEL #	STOCK #	DESCRIPTION	DIMENS (OUTSIDE: L x W x D)	PACKED
T9200	6784TE	Translucent w/Black Handle & Latches Includes 7 Removable Dividers*	15-7/32" x 14-5/32" x 6-7/32" (38.66 x 35.96 x 15.80 cm)	3/ctn

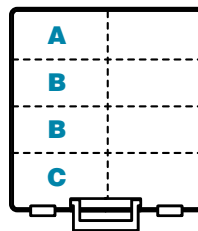

T9200 Double Deep Super Satchel (L x W):

- A = (1 row of 2 compts) 6-1/4" x 3.0" (15.88 x 7.62 cm),
- B = (2 rows of 4 compts) 6-1/4" x 3-1/4" (15.88 x 8.26 cm),
- C = (1 row of 2 compts) 6-1/4" x 2-3/4" (15.88 x 6.99 cm)

*Please Note: additional divider packs sold separately on (page 5)

Satchel-Style Cases: Small

A fantastic heavy-duty professional case! The Satchel case is commonly used as a parts or sales sample kit. The tinted lid is made of a high impact, scratch-resistant terpolymer, that gives you a quick view of parts. The base, dividers, handle & catches are all molded from impact resistant polypropylene.

Features:

- Can Be Customized (Color / Company Logo)
- Rust-Proof Heavy-Duty Hinges

MODEL #	STOCK #	DESCRIPTION	DIMENS (OUTSIDE: L x W x D)	PACKED
711-2	6771UA	Tinted Translucent Lid, 1 Compt	15-1/2" x 11-3/4" x 2-1/2" (39.37 x 28.85 x 6.35 cm)	12/ctn
724-2	6770PA	Tinted Translucent Lid, 9-24 Compts, Includes 15 Removable Dividers*	15-1/2" x 11-3/4" x 2-1/2" (39.37 x 28.85 x 6.35 cm)	12/ctn
725-2 ©	6773AB	Double-Sided, Tinted Translucent Lid, 10-25 Compts, Inclds 15 Removable Dividers*	15-1/2" x 11-3/4" x 5.0" (39.37 x 28.85 x 12.70 cm)	6/ctn
748-2	6772AD	Double-Sided, Tinted Translucent Lid, 18-48 Compts, Inclds 30 Removable Dividers*	15-1/2" x 11-3/4" x 5.0" (39.37 x 28.85 x 12.70 cm)	6/ctn

*Divider Packs Available (sold separately): 12pk of dividers for 724-2, 725-2 & 748-2 is order #6020DP.
Bulk pkgs of dividers for 724-2, 725-2 & 748-2 is order #602025

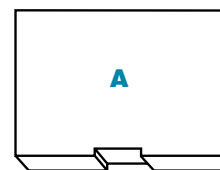
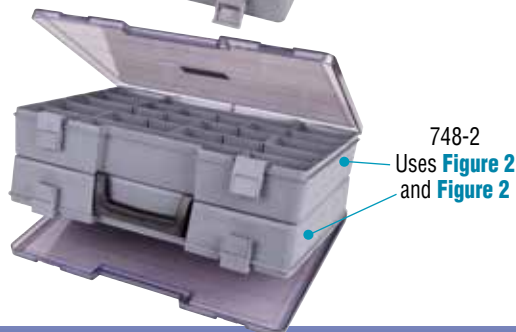
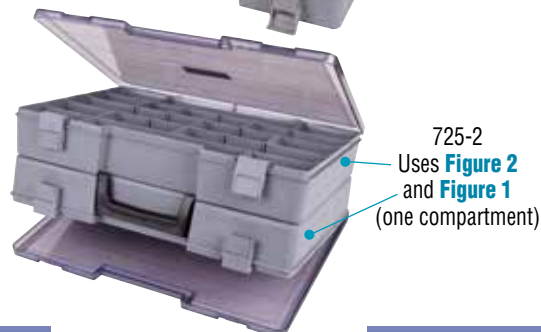

Figure 1:

Compartment (L x W):

A = 14-5/8" x 10-1/8" (25.72 x 37.15 cm)

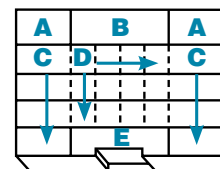

Figure 2:

Compartments (L x W):

A = 2-1/8" x 3-1/8" (5.40 x 7.94 cm),

B = 2-1/8" x 8-1/8" (5.40 x 20.64 cm),

C = 2.0" x 3-1/8" (5.08 x 7.94 cm),

D = 2.0" x 2.0" (5.08 x 5.08 cm),

E = 1-1/2" x 8-1/8" (3.81 x 20.64 cm)

Satchel-Style Cases: Large

A fantastic heavy-duty professional case! The Satchel case is commonly used as a parts or sales sample kit. The tinted lid is made of a high clarity and good impact resistant polymer, that gives you a quick view of parts. The base, dividers, handle & catches are all molded from impact resistant polypropylene.

Features:

- Can Be Customized (Color / Company Logo)
- Rust-Proof Heavy-Duty Hinges

MODEL #	STOCK #	DESCRIPTION	DIMENS (OUTSIDE: L x W x D)	PACKED
1016-2	6745AB	Tinted Translucent Lid, 32 Compts, Includes 12 Removable Dividers*	18-1/2" x 13.0" x 3.0" (46.99 x 33.02 x 7.62 cm)	6/ctn
1021-2	6745AG	Tinted Translucent Lid, 21 Compts	18-1/2" x 13.0" x 3.0" (46.99 x 33.02 x 7.62 cm)	6/ctn
1024-2	6745AA	Tinted Translucent Lid, 24 Compts	18-1/2" x 13.0" x 3.0" (46.99 x 33.02 x 7.62 cm)	6/ctn
1032-2	6745AC	Tinted Translucent Lid, 32 Compts, Includes 24 Removable Dividers*	18-1/2" x 13.0" x 3.0" (46.99 x 33.02 x 7.62 cm)	6/ctn

*Divider Packs Available (sold separately): 12pk of dividers for 1016-2 is order #6014DP. Bulk pks of dividers for 1016-2 is order #601312. 12pk of dividers for 1032-2 is order #6013DP. Bulk pks of dividers for 1032-2 is order #601303.

(32) Compartments



1016-2

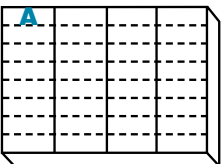

Compartments (L x W):
A = 4.0" x 3.0" (10.16 x 7.62 cm)

(21) Compartments



1021-2

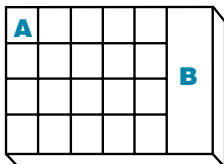

Compartments (L x W):
A = 2-7/8" x 3.0" (7.30 x 7.62 cm),
B = 4.0" x 13.0" (10.16 x 33.02 cm)

(24) Compartments



1024-2

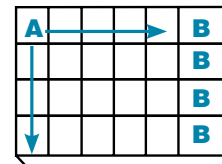

Compartments (L x W):
A = 2-7/8" x 3.0" (7.30 x 7.62 cm),
B = 4.0" x 3.0" (10.16 x 7.62 cm)

(32) Compartments



1032-2

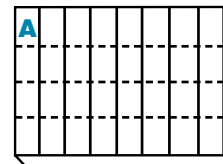

Compartments (L x W):
A = 2-1/8" x 2-15/16" (5.40 x 7.46 cm)



For Customer Service Inquiries Call: 1(800) 344-5716



Tool Boxes: Utility Series

Industrial Grade: Flambeau Utility Series boxes are engineered tough. With thick wall construction and interior "I" beam support structures, you can expect the Utility Series boxes to out-perform most any other box! Finally, our heavy-duty cantilever trays are secured by rust-resistant hardware for extra longevity.

Features:

- Resistant to oil & common chemicals
- Lockable
- Tip-Guard™ (cantilever trays only)
- Dent-proof
- Removable Interior Trays
- Scratch resistant

Blow Molding Small Tool Box

- Lift-out tray sits on a "lip" at the top of the tool box base
- Tray size is larger than bottom dimension of tool box
- Injection molded hardware
- Routed base for more storage space



Blow Molding Large Tool Box

- Lift-out tray sits on a "lip" at the top of the tool box base
- Tray size is larger than bottom dimension of tool box
- Injection molded handle with large integral latch
- Double wall construction for extra strength



* Express Service (E Symbol) items are for quantities 500 and less.
For greater quantities call customer service: 1-800-344-5716.

MODEL #	STOCK #	DESCRIPTION	DIMENS. (INSIDE: L x W x D)	DIMENS. (OUTSIDE: L x W x D)	LID, BASE DEPTH DIMENS.	TRAY DIMENS. (L x W x D)	PACKED
50042 E	50042	Black, Small Tool Box	15-1/2" x 4-3/4" x 4.0" (39.37 x 12.07 x 10.16 cm)	15-5/8" x 4-15/16" x 4-11/16" (39.69 x 12.54 x 11.91 cm)	Lid: 1-7/8" (4.76 cm) Base: 2-13/16" (7.14 cm)	16-5/8" x 4-15/16" x 1-1/4" (42.23 x 12.54 x 3.18 cm)	30/ctn
50043 E	50043 21470	Black, Large Tool Box	18-1/4" x 7-1/2" x 5-3/4" (46.36 x 19.05 x 14.61 cm)	19-7/8" x 8-5/16" x 7.0" (50.48 x 21.11 x 17.78 cm)	Lid: 3-1/2" (8.89 cm) Base: 3-1/2" (8.89 cm)	16-5/8" x 4-15/16" x 1-1/4" (42.23 x 12.54 x 3.18 cm)	8/ctn

Tool Boxes: Utility Boxes

Flambeau Utility Boxes feature spacious open interiors & are manufactured from light-weight copolymer resins that are non-conductive, dent-proof, rust-proof and scratch-resistant.

Features:

- Brass Hinge and Latch Pins, Tough Recessed Handles
- Positive Action Latches
- Models 1800 & 2100 Have (2) 3/16" (2.06 Cm) Lock Tabs
- Textured Finish & Tongue-And-Groove Construction

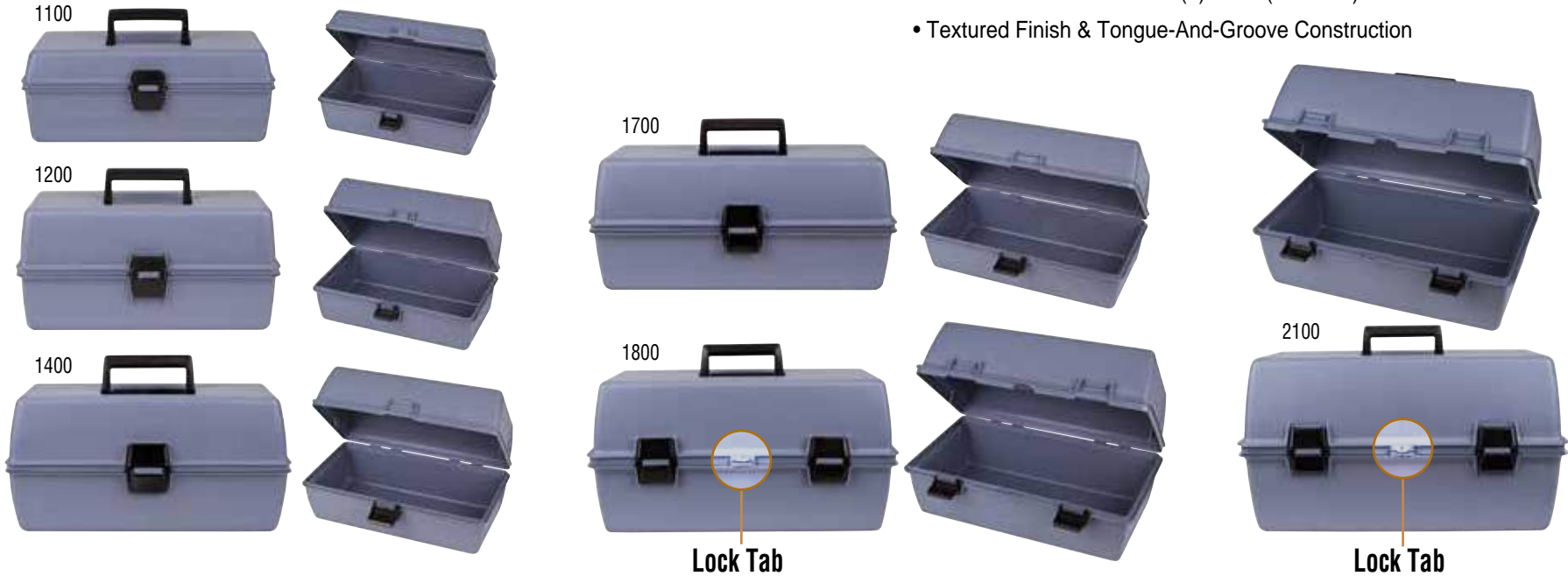

MODEL #	STOCK #	DESCRIPTION	DIMENS. (INSIDE: L x W x D)	DIMENS. (OUTSIDE: L x W x D)	LID, BASE DEPTH DIMENS.	PACKED
1100	6734UB	Gray Utility Box	11-1/8" x 5-3/4" x 4.0" (28.26 x 14.61 x 10.16 cm)	12-1/8" x 7-1/4" x 4-1/2" (30.80 x 18.42 x 11.43 cm)	Lid: 1-3/4" (4.45 cm) Base: 2-3/4" (6.99 cm)	6/ctn
1200	6736UB	Gray Utility Box	11-1/8" x 5-3/4" x 5-1/4" (28.26 x 14.61 x 13.34 cm)	12-1/8" x 7-1/4" x 5-1/2" (30.80 x 18.42 x 13.97 cm)	Lid: 2-3/4" (6.99 cm) Base: 2-3/4" (6.99 cm)	6/ctn
1400	6742UB	Gray Utility Box	13.0" x 6.0" x 6-1/4" (33.02 x 15.24 x 15.88 cm)	14-3/8" x 8.0" x 7.0" (36.51 x 20.32 x 17.78 cm)	Lid: 3-1/2" (8.89 cm) Base: 3-1/2" (8.89 cm)	6/ctn
1700	6746UB	Gray Utility Box	15.0" x 6-3/4" x 6-1/2" (38.10 x 17.14 x 16.51 cm)	16-3/8" x 8-5/8" x 7.0" (41.59 x 21.91 x 17.78 cm)	Lid: 3-1/2" (8.89 cm) Base: 3-1/2" (8.89 cm)	4/ctn
1800	6752UB	Gray Utility Box: Has 3/16" (2.06 cm) Dia. Lock Tab	15-5/8" x 6-1/2" x 7-3/4" (39.69 x 16.51 x 19.69 cm)	17-1/2" x 10-1/4" x 8-1/2" (44.45 x 26.04 x 21.59 cm)	Lid: 4-1/4" (10.80 cm) Base: 4-1/4" (10.80 cm)	4/ctn
2100	6760UB	Gray Utility Box: Has 3/16" (2.06 cm) Dia. Lock Tab	17-1/8" x 8-5/8" x 9-1/4" (43.50 x 21.91 x 23.50 cm)	19.0" x 11-1/2" x 10-1/2" (48.26 x 29.21 x 26.67 cm)	Lid: 5-1/4" (13.34 cm) Base: 5-1/4" (13.34 cm)	2/ctn



For Customer Service Inquiries Call: 1(800) 344-5716



Tool Boxes: Utility/Tool Boxes w/Lift-Out Trays & Lock Tabs

Utility Chest



14800-2



17800-2



19800-2



19804



23800-2



27800-2

MODEL #	STOCK #	DESCRIPTION	DIMENS. (INSIDE: L x W x D)	DIMENS. (OUTSIDE: L x W x D)	LID, BASE DEPTH DIMENS.	TRAY DIMENS. (L x W x D)	PACKED
14800-2	6744HS	Gray w/3/16" (2.06 cm) Diameter Lock Tab	13.0" x 5-3/8" x 4-1/4" (33.02 x 13.65 x 10.80 cm)	14-1/2" x 7-1/2" x 5-1/4" (36.83 x 19.05 x 13.34 cm)	Lid: 1-1/2" (3.81 cm) Base: 3-1/2" (8.89 cm)	12-1/4" x 4-3/4" x 1-1/2" (31.12 x 12.07 x 3.81 cm)	6/ctn
17800-2	6748HS	Gray w/3/16" (2.06 cm) Diameter Lock Tab	14-1/2" x 6-1/8" x 6.0" (36.83 x 15.56 x 15.24 cm)	16-5/8" x 8-3/4" x 7-1/8" (42.23 x 22.23 x 18.10 cm)	Lid: 2-1/8" (5.40 cm) Base: 4-3/4" (12.07 cm)	13-3/4" x 5-5/8" x 1-7/8" (34.93 x 14.29 x 4.76 cm)	4/ctn
19800-2	6757HS	Gray w/3/16" (2.06 cm) Diameter Lock Tab	18-1/8" x 6-1/2" x 7-1/8" (46.36 x 16.51 x 18.10 cm)	20-1/4" x 8-7/8" x 8-3/8" (51.44 x 22.54 x 21.27 cm)	Lid: 2-3/8" (6.03 cm) Base: 7.0" (17.78 cm)	17-5/8" x 6-3/8" x 2-3/16" (44.77 x 16.19 x 5.56 cm)	4/ctn
19804	6757TY	Yellow w/3/16" (2.06 cm) Diameter Lock Tab	18-1/8" x 6-1/2" x 7-1/8" (46.36 x 16.51 x 18.10 cm)	20-1/4" x 8-7/8" x 8-3/8" (51.44 x 22.54 x 21.27 cm)	Lid: 2-3/8" (6.03 cm) Base: 7.0" (17.78 cm)	17-5/8" x 6-3/8" x 2-3/16" (44.77 x 16.19 x 5.56 cm)	4/ctn
23800-2	6759HS	Gray w/3/16" (2.06 cm) Diameter Lock Tab	20-5/8" x 7-1/2" x 10.0" (52.39 x 19.05 x 25.40 cm)	23.0" x 10-1/2" x 11-3/8" (58.42 x 26.67 x 28.89 cm)	Lid: 2-1/2" (6.35 cm) Base: 8-3/8" (21.27 cm)	20-5/8" x 7-1/2" x 2.0" (52.39 x 19.05 x 5.08 cm)	2/ctn
27800-2	6754TC	Gray w/3/16" (2.06 cm) Diameter Lock Tab	23.0" x 12-1/2" x 12.0" (58.42 x 31.75 x 30.48 cm)	27-1/2" x 13-3/4" x 14.0" (69.85 x 35.93 x 35.56 cm)	Lid: 3-1/2" (8.89 cm) Base: 10-3/8" (26.35 cm)	11-1/2" x 2-1/4" x 11.0" (29.21 x 5.72 x 27.94 cm)	2/ctn

Tool Boxes: Utility Boxes with Cantilever Trays

Rugged Utility Boxes featuring Tip-Guard™ cantilever trays make it easy to organize tools and parts, repair kits, samples or sports equipment in a small space. Manufactured from light-weight copolymer resins that are dent-proof, rust-proof & scratch-resistant, these Utility Boxes are also resistant to oils and most common chemicals.

2-Tray Boxes

17090-2



17090-2 Tray Configuration

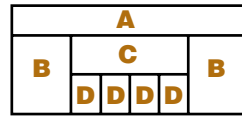

Top Tray (from front of box)



Bottom Tray (from front of box)

17090-2

Tray Compartments (Inside L x W x D):

- A = 14-1/4" x 1-7/8" x 1-5/16" (36.20 x 4.76 x 3.33 cm),
- B = 3-1/2" x 3-3/16" x 1-5/16" (8.89 x 8.10 x 3.33 cm),
- C = 7.0" x 1-7/8" x 1-5/16" (17.78 x 4.76 x 3.33 cm),
- D = 1-11/16" x 1-7/8" x 1-5/16" (4.29 x 4.76 x 3.33 cm),
- E = 6.0" x 5-3/4" x 1-5/16" (15.24 x 14.61 x 3.33 cm),
- F = 4.0" x 5-3/4" x 1-5/16" (10.16 x 14.61 x 3.33 cm)

Features:

- Tough Recessed Handles
- Cantilever Tip-Guard Tray Supports
- Brass Hinge and Latch Pins
- Tongue-And-Groove Construction
- Trays Are a Light Gray
- Positive-Action Latches

18090-2



18090-2 Tray Configuration

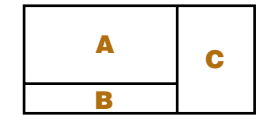

Top Tray (from front of box)



Bottom Tray (from front of box)

18090-2

Tray Compartments (Inside L x W x D):

- A = 9.0" x 7.0" x 1-3/4" (22.86 x 17.78 x 4.45 cm),
- B = 9.0" x 2-1/4" x 1-3/4" (22.86 x 5.72 x 4.45 cm),
- C = 5-1/2" x 7.0" x 1-3/4" (13.97 x 17.78 x 4.45 cm),
- D = 2-7/16" x 7.0" x 1-3/4" (6.19 x 17.78 x 4.45 cm),
- E = 6-1/4" x 7.0" x 1-3/4" (15.88 x 17.78 x 4.45 cm)

MODEL #	STOCK #	DESCRIPTION	DIMENS. (INSIDE: L x W x D)	DIMENS. (OUTSIDE: L x W x D)	LID, BASE DEPTH DIMENS.	PACKED
17090-2	6749HS	Gray, 2 Cantilever Trays 11 Compartments	15.0" x 6-3/4" x 6-1/2" (38.10 x 17.15 x 16.51 cm)	16-3/8" x 8-5/8" x 7.0" (41.59 x 21.91 x 17.78 cm)	Lid: 3-1/2" (8.89 cm) Base: 3-1/2" (8.89 cm)	4/ctn
18090-2	6755HS	Gray, 2 Cantilever Trays 8 Compartments	15-5/8" x 6-1/2" x 7-3/4" (39.69 x 16.51 x 19.69 cm)	17-1/2" x 10-1/4" x 8-1/2" (44.45 x 26.04 x 21.59 cm)	Lid: 4-1/2" (10.80 cm) Base: 4-1/2" (10.80 cm)	4/ctn
19060-2	6756HS	Gray, 6 Cantilever Trays 35 Compartments	15-1/2" x 7-1/4" x 8-1/2" (39.37 x 18.42 x 21.59 cm)	18-1/2" x 10-3/4" x 10-3/8" (46.99 x 27.31 x 26.35 cm)	Lid: 4-3/4" (12.70 cm) Base: 4.0" (10.16 cm)	1/ctn

6-Tray Boxes



19060-2

19060-2 Tray Configuration



Top Tray - Right Bank
(from front of box)



Middle Tray - Right Bank
(from front of box)



Bottom Tray - Right Bank
(from front of box)



Top Tray - Left Bank
(from front of box)



Middle Tray - Left Bank
(from front of box)



Bottom Tray - Left Bank
(from front of box)

19060-2

Tray Compartments (Inside L x W x D):

- A = 14-1/2" x 2-3/4" x 1.0" (36.83 x 6.99 x 2.54 cm),
- B = 1-3/4" x 2-3/4" x 1.0" (4.45 x 6.99 x 2.54 cm),
- C = 1-7/8" x 2-7/8" x 1-5/16" (4.76 x 7.30 x 3.33 cm),
- D = Slant Divider Wall: 12-1/2" x 1-5/8" & 2-3/8" x 1-5/16" (31.75 x 4.13 x 6.03 x 3.33 cm),
- E = 14-1/2" x 1-3/8" x 1-5/16" (36.83 x 3.49 x 3.33 cm),
- F = 1-1/2" x 4-3/8" x 1-5/16" (3.81 x 11.11 x 3.33 cm),
- G = 8-1/8" x 4-3/8" x 1-5/16" (20.64 x 11.11 x 3.33 cm)



Tool Boxes: Low Boy™ Tool Box

This low profile tool box has an ergonomic handle and is manufactured from light-weight copolymer resins that are non-conductive, dent-proof, rust-proof & scratch-resistant.



18192-2

MODEL #	STOCK #	DESCRIPTION	DIMENS. (INSIDE: L x W x D)	DIMENS. (OUTSIDE: L x W x D)	PACKED
18192-2	6735HS	Yellow	17.0" x 10-1/2" x 3-5/8" (43.18 x 26.67 x 9.21 cm)	18-1/2" x 12-1/2" x 6.0" (46.99 x 31.75 x 15.24 cm)	4/ctn

Expandable Building Box

Manufactured from light-weight copolymer resins that are non-conductive, dent-proof, rust-proof & scratch-resistant.

Features:

- Ergonomic handle
- Includes (2), 999-2 Infinite Divider System™ Boxes
- Additional trays available with Expansion Kit



13900-2

MODEL #	STOCK #	DESCRIPTION	DIMENS. (INSIDE: L x W x D)	DIMENS. (OUTSIDE: L x W x D)	PACKED
13900-2	6730HS	Yellow and Black	18.0" x 11.0" x 3-1/2" (45.72 x 27.94 x 8.89 cm)	18-1/2" x 12-1/2" x 11-3/4" (46.99 x 31.75 x 28.85 cm)	4/ctn

Expansion Kit

- Additional trays available with Expansion Kit



13901-2



999-2

Infinite Divider Box (Inside L x W x D):
13-1/8" x 8-7/8" x 1-15/16" (33.34 x 22.54 x 4.92 cm)

MODEL #	STOCK #	DESCRIPTION	DIMENS. (INSIDE: L x W x D)	DIMENS. (OUTSIDE: L x W x D)	PACKED
13901-2	6731HS	Expansion Kit: Black	13-1/2" x 9-1/4" x 2-3/4" (34.29 x 23.50 x 6.99 cm)	16-3/16" x 10-1/16" x 3-1/4" (41.12 x 25.56 x 8.26 cm)	6/ctn

Tool Boxes: Gear Boxes

These Gear Boxes are perfect for Medical Supplies, Safety Equipment, Auto Repair Kits, Test Equipment, Art Supplies, Maintenance & Repair Supplies, Firearm Supplies and much more.

Features:

- Deep Open Interior
- Gasket in Lid
- Lift-Out Tray
- Snap-Open Lid with Storage
- Cam-Over Latch Design
- Oversized Handle & Latch
- Tongue-And-Groove Design

Benefits:

- Accommodates Large, Tall Parts & Equipment
- Keeps Content Dry & Protected in Extreme Environments
- Provides Added Strength
- Helps Keep Dust & Contaminates Out
- Perfect For Storing Small Parts
- Keeps Everything Organized & At Your Fingertips
- Secures Contents In Main Compartment



All models include a 360° gasket in the lid which keeps contents dry and protected from some of the most extreme environments.



As an option, both sizes can be molded in Zerust® Corrosion Inhibitor creating an invisible barrier to fight against corrosion. (See page 4)



T1100



T1400



T1408B



T1418



All sizes available in custom colors. (See page 3)

MODEL #	STOCK #	DESCRIPTION	DIMENS. (INSIDE: L x W x D)	TRAY DIMENS: L x W x D)	INSIDE CLEARANCE UNDER TRAY (DEPTH)	PACKED
T1100	5415GB	Mini, Black with No Lift-Out Tray	6-7/8" x 3-1/2" x 5-1/2" (17.46 x 8.89 x 13.97 cm)	-	-	6/ctn
T1400	6415GB	Small, Black with No Lift-Out Tray	9-1/5" x 4-1/4" x 6.0" (23.37 x 10.80 x 15.24 cm)	-	-	6/ctn
T1408B	6430TD	Medium, Black with Lift-Out Tray	13.0" x 6-3/4" x 7-1/4" (33.02 x 17.15 x 18.42 cm)	12-3/4" x 6-1/2" x 2.0" (32.39 x 16.51 x 5.08 cm)	5-1/4" (13.33 cm)	4/ctn
T1418	6917GB	Large, Black w/Lift-Out Tray w/2 Removable Dividers	16-1/2" x 10.0" x 10-1/2" (41.91 x 25.40 x 26.67 cm)	16.0" x 9-3/4" x 2-1/2" (40.64 x 24.76 x 6.35 cm)	7.0" (17.78 cm)	2/ctn



For Customer Service Inquiries Call: 1(800) 344-5716



Tool Boxes: Lil' Brute Tool Box

Super Satchel style handle with L-089 "quick-snap" latches. Available with or without lift-out tray (trays are not sold separately). Customize with colors or hot stamp options (see page 4). A fantastic value!



Front View



Side View



13815-2 Without Tray

13805-2 with Tray
(Tray not sold separately)



MODEL #	STOCK #	DESCRIPTION	DIMENS. (INSIDE: L x W x D)	DIMENS. (OUTSIDE: L x W x D)	LID, BASE DEPTH DIMENS.	TRAY DIMENS. (L x W x D)	PACKED
13805-2	6743HS	Black w/Tray	12.0" x 4-3/4" x 4-3/4" (30.48 x 12.07 x 12.07 cm)	13.0" x 6.0" x 5-3/8" (33.02 x 15.24 x 13.65 cm)	Lid: 1/2" (1.27 cm) Base: 4-1/4" (10.80 cm)	12.0" x 4-3/8" x 1.0" (30.48 x 11.11 x 2.54 cm)	6/ctn
13815-2	6742HS	Black w/Out Tray	12.0" x 4-3/4" x 4-3/4" (30.48 x 12.07 x 12.07 cm)	13.0" x 6.0" x 5-3/8" (33.02 x 15.24 x 13.65 cm)	Lid: 1/2" (1.27 cm) Base: 4-1/4" (10.80 cm)		6/ctn

Utility Tote

- Copolymer resins resist scratching, fading and rusting
- Has a large built-in handle and pull-out tray on bottom can be opened from either side
- Ideal for service areas or vehicles
- Drawer with 12 compartments (drawer dimens. L x W x D: 13-3/4" x 9.0" x 1-1/2" (34.93 x 22.86 x 3.81 cm))

16500-2



Front View



MODEL #	STOCK #	DESCRIPTION	DIMENS. (INSIDE: L x W x D)	DIMENS. (OUTSIDE: L x W x D)	PACKED
16500-2	6769HS	Black with Light Gray Drawer	13-3/4" x 9.0" x 4.0" (34.93 x 22.86 x 10.16 cm)	16-5/8" x 10-1/4" x 6-7/8" (42.23 x 26.04 x 17.46 cm)	6/ctn

Utility Bench Box

- Spacious 20" x 8" x 4" (50.8 x 20.32 x 10.16 cm) top
- Two large pull-out drawers with (2) compartments in drawer one and (2) compartments in drawer two
- Drawer dimensions are 18-3/8" x 5-7/8" x 1-7/8" (46.67 x 14.92 x 4.76 cm)
- Drawers can be secured from accidental opening
- Includes two (2) removable dividers for each drawer
- Fold-down handle

21800-2



MODEL #	STOCK #	DESCRIPTION	DIMENS. (INSIDE: L x W x D)	DIMENS. (OUTSIDE: L x W x D)	PACKED
21800-2 ©	6758HS	Black w/2 Light Gray Drawers	20.0" x 8.0" x 4.0" (50.80 x 20.32 x 10.16 cm)	21-3/4" x 10-3/4" x 9-3/8" (55.25 x 27.31 x 23.81 cm)	1/ctn

Tool Chests

Flambeau Tool Chests are designed to organize, store and protect precision tools, hardware and small parts. They feature a unique front panel design that allows drawer access when the front panel is down. A unique lock prevents accidental spills and allows the lid and drawers to lift as a unit, providing access to the large lower storage area.

Features:

- Resistant to most common chemicals, solvents and oils
- Positive-action latches
- Lockable with brass hinges and latch pins
- Large gray interchangeable drawers with adjustable compartment sizes
- Molded in industrial-grade ABS plastic

See Replacement Order Information On (Page 93)

22030-2

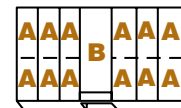

22030-2

Drawer B (#AR841-45):

L = 15-9/16" (39.53 cm),
W = 8-13/16" (22.84 cm),
D = 1-3/8" (3.49 cm)

22030-2

Drawer B Compartments (L x W x D):

A = 1-15/16" x 4-1/2" x 1-1/4" (4.92 x 11.43 x 3.18 cm),
B = 3-3/16" x 8-7/8" x 1-1/4" (8.10 x 22.54 x 3.18 cm)

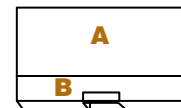

Drawer F (#AR897-45):

L = 15-9/16" (39.53 cm),
W = 8-13/16" (22.84 cm),
D = 1-3/8" (3.49 cm)

Drawer F Compartments (L x W x D):

A = 15-1/8" x 6-3/16" x 1-1/4" (38.42 x 15.72 x 3.18 cm),
B = 15-1/8" x 2-7/16" x 1-1/4" (38.42 x 6.19 x 3.18 cm)

MODEL #	STOCK #	DESCRIPTION	DIMENSIONS (OUTSIDE: L x W x D)	PACKED
22030-2 ©	6759CH	Gray with Light Gray Drawers	19-1/2" x 11-1/2" x 11-3/4" (49.53 x 29.21 x 29.85 cm)	1/ctn



For Customer Service Inquiries Call: 1(800) 344-5716



Tool Boxes: Drawer Cabinets

Flambeau Drawer Cabinets are designed to organize, store and protect precision tools, hardware and small parts. Featuring a self-storing door panel providing all-weather protection for the contents inside.

Features:

- Molded in industrial grade ABS plastic
- Resistant to most common chemicals, solvents and oils
- Lockable with positive-action latches
- Brass hinges and latch pins

*Know exactly where
you can get your hands
on your hardware when
you store it in this box!*



Front View



Side View



2275-2



2277-2



2276-2
(Props not included)

**See Drawer Cabinet and Tool Chest drawer dimensions on next page*

MODEL #	STOCK #	DESCRIPTION	DIMENS. (OUTSIDE: L x W x D)	* DRAWER CONFIGURATIONS (see page 93)	PACKED
22060 © (not shown)	6596DH	Gray with Light Gray Drawers	19-1/2" x 11-1/2" x 11-3/4" (49.53 x 29.21 x 29.85 cm)	(4) B, (1) C & (1) F	1/ctn
2275-2	6763DB	Gray with Light Gray Drawers	19-1/2" x 10-3/8" x 15.0" (49.53 x 26.35 x 38.10 cm)	(2) B, (2) D & (1) E	1/ctn
2276-2	6764DB	Gray with Light Gray Drawers	19-1/2" x 10-3/8" x 15.0" (49.53 x 26.35 x 38.10 cm)	(1) A, (3) B, (1) C & (1) D	1/ctn
2277-2	6765DB	Gray with Light Gray Drawers	19-1/2" x 10-3/8" x 15.0" (49.53 x 26.35 x 38.10 cm)	(1) A, (2) B & (4) D	1/ctn

Tool Boxes

Drawer Cabinets and Tool Chests Drawer Dimensions



Drawer A (#AR839-45):
L = 15-9/16" (39.53 cm),
W = 8-13/16" (22.84 cm),
D = 1-3/8" (3.49 cm)

Drawer A Compartments (L x W x D):
A = 1-15/16" x 6-3/16" x 1-1/4" (4.92 x 15.72 x 3.18 cm),
B = 7-5/16" x 6-3/16" x 1-1/4" (18.57 x 15.72 x 3.18 cm),
B = 15-1/8" x 2-7/16" x 1-1/4" (5.08 x 7.94 x 3.18 cm)

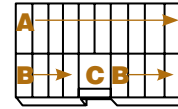

Drawer D (#AR840-45):
L = 15-9/16" (39.53 cm),
W = 8-13/16" (22.84 cm),
D = 1-3/8" (3.49 cm)

Drawer D Compartments (L x W x D):
A = 1-3/8" x 5-1/16" x 1-1/4" (3.49 x 12.86 x 3.18 cm),
B = 1-3/8" x 3-9/16" x 1-1/4" (3.49 x 9.05 x 3.18 cm),
C = 3-3/16" x 3-9/16" x 1-1/4" (8.10 x 9.05 x 3.18 cm)

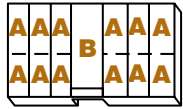

Drawer B (#AR841-45):
L = 15-9/16" (39.53 cm),
W = 8-13/16" (22.84 cm),
D = 1-3/8" (3.49 cm)

Drawer B Compartments (L x W x D):
A = 1-15/16" x 4-1/2" x 1-1/4" (4.92 x 11.43 x 3.18 cm),
B = 3-3/16" x 8-7/8" x 1-1/4" (8.10 x 22.54 x 3.18 cm)



Drawer E (#AR928-45):
L = 15-9/16" (39.53 cm),
W = 8-13/16" (22.84 cm),
D = 4-7/16" (11.27 cm)

Drawer E Compartments (L x W x D):
A = 15-1/8" x 8-5/8" x 4-5/16" (38.42 x 21.91 x 10.95 cm)



Drawer C (#AR869-45):
L = 15-9/16" (39.53 cm),
W = 8-13/16" (22.84 cm),
D = 2-7/8" (7.30 cm)

Drawer C Compartments (L x W x D):
A = 15-1/8" x 8-5/8" x 2-5/8" (38.42 x 21.91 x 6.67 cm)

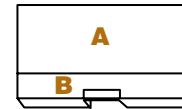

Drawer F (#AR869-45):
L = 15-9/16" (39.53 cm),
W = 8-13/16" (22.84 cm),
D = 1-3/8" (3.49 cm)

Drawer F Compartments (L x W x D):
A = 15-1/8" x 6-3/16" x 1-1/4" (38.42 x 15.72 x 3.18 cm),
B = 15-1/8" x 2-7/16" x 1-1/4" (38.42 x 6.19 x 3.18 cm)

Drawer Cabinets and Tool Chests Replacement Drawer Packs

- Each replacement drawer pack includes (6) drawers

MODEL #	STOCK #	DESCRIPTION	PACKED
AR839-45	6073DP	Drawer A	6/ctn
AR841-45	6069DP	Drawer B	6/ctn
AR869-45	6071DP	Drawer C	6/ctn
AR840-45	6072DP	Drawer D	6/ctn
AR928-45	6060DP	Drawer E	6/ctn
AR897-45	6070DP	Drawer F	6/ctn

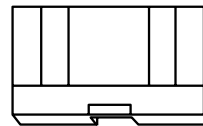

Drawer A (#AR839-45):
L = 15-9/16" (39.53 cm),
W = 8-13/16" (22.84 cm),
D = 1-3/8" (3.49 cm)

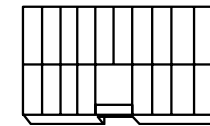

Drawer D (#AR840-45):
L = 15-9/16" (39.53 cm),
W = 8-13/16" (22.84 cm),
D = 1-3/8" (3.49 cm)

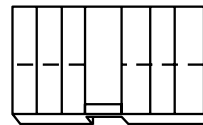

Drawer B (#AR841-45):
L = 15-9/16" (39.53 cm),
W = 8-13/16" (22.84 cm),
D = 1-3/8" (3.49 cm)



Drawer E (#AR928-45):
L = 15-9/16" (39.53 cm),
W = 8-13/16" (22.84 cm),
D = 4-7/16" (11.27 cm)



Drawer C (#AR869-45):
L = 15-9/16" (39.53 cm),
W = 8-13/16" (22.84 cm),
D = 2-7/8" (7.30 cm)



Drawer F (#AR869-45):
L = 15-9/16" (39.53 cm),
W = 8-13/16" (22.84 cm),
D = 1-3/8" (3.49 cm)

Dimensions listed are overall dimensions



For Customer Service Inquiries Call: 1(800) 344-5716



Specialty Storage: IDS™ Cabinets - Infinite Divider Storage™ System

A hybrid between mobile & stationary storage, these cabinets have interlocking grooves for easy and secure stacking. The IDS™ system truly gives you mastery over your storage space with (5) IDS translucent cases featuring dividers that can be placed every 1/16" (0.16 cm) throughout the compartments!

Features:

- Infinite Divider System™ (IDS)
- Resistant to oil & common chemicals
- Interlocking stackable cabinets
- Dent-proof
- Fully extendable drawers
- Removable cases



Dividers can be placed at 1/16" (0.16 cm) increments throughout the entire box

T900



Infinite Divider Box (Inside L x W x D):
13-1/8" x 8-7/8" x 1-15/16" (33.34 x 22.54 x 4.92 cm)

999-2



Infinite Divider Box (Inside L x W x D):
13-1/8" x 8-7/8" x 1-15/16" (33.34 x 22.54 x 4.92 cm)



Stackable!



Special interlocking grooves on the cabinets allow them to be stacked on top of each other.

8500NT



8500ST



8500JT



MODEL #	STOCK #	DESCRIPTION	DIMENS. (OUTSIDE: L x W x D)	PACKED
8500NT	8500NT	Cabinet with 5 Trays, No Boxes	15-1/4" x 14-3/4" x 16.0" (38.74 x 37.47 x 40.64 cm)	1/ctn
8500ST	8500ST	Cabinet with 5 Trays and 5 T900 Boxes T900 Boxes Come with 16 IDS™ Dividers	15-1/4" x 14-3/4" x 16.0" (38.74 x 37.47 x 40.64 cm)	1/ctn
8500JT	8500JT	Cabinet with 5 Trays and 5 999-2 Boxes 999-2 Boxes Come with 16 IDS Dividers	15-1/4" x 14-3/4" x 16.0" (38.74 x 37.47 x 40.64 cm)	1/ctn

*See Compartment Box section (pages 8 - 55) for additional boxes that will work within these cabinets. Check (page 5) for replacement IDS Dividers

Specialty Storage: Carry Packs™

From the shelf or wall (mountable), this system gives you the high-density storage and organization you need and the freedom to easily get your parts to the work site.

Features:

- Boxes lock in place for ease of folding and carrying
- Each box can be quickly disengaged for part access
- Carry Pack frames are available with or without boxes



21210-2
shown closed and flat

6701NB Frame Diagram

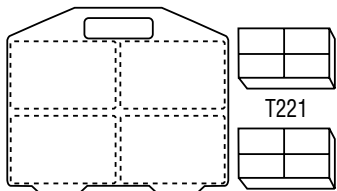

T220 & T221 Dimens:
L = 4-3/8" (11.11 cm),
W = 2-5/8" (6.67 cm),
D = 1.0" (2.54 cm)

20220-2

Includes (2) T220 & T221 trans. polypropylene boxes

Additional boxes that fit: 20220-2

A220 K220 M220
 A221 K226 M221
 A226
 A228

* Additional boxes sold separately

6709NB Frame Diagram

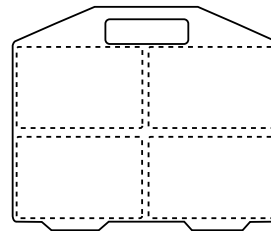

T210 & T215 Dimens:
L = 6-3/4" (17.15 cm),
W = 3-3/16" (8.10 cm),
D = 1-3/16" (3.02 cm)

21210-2

Includes (2) T210 & T215 trans. polypropylene boxes

Additional boxes that fit: 21210-2

A210 A211 K210 M210 T219
 A212 A213 K215 M215
 A214 A215 K216
 A216 A217 K219
 A219

6728NB Frame Diagram

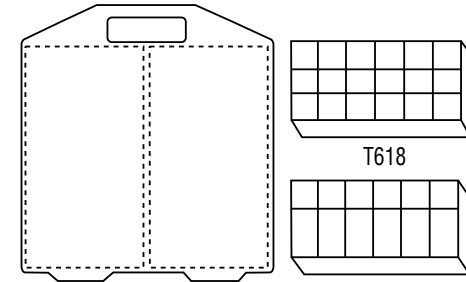

T612 & T618 Dimens:
L = 10-1/2" (26.67 cm),
W = 6-3/16" (15.72 cm),
D = 1-9/16" (3.97 cm)

21600-2

Includes (2) T612 & T618 trans. polypropylene boxes

Additional boxes that fit: 21600-2

A601 A602 K601 K602 M602 T606
 A603 A606 K606 K607 M606 T616R
 A607 A613 K616R K618 M612
 A612 A618 K623 M618
 A623 M623

*See Compartment Box section (pages 8 - 55) for additional boxes

MODEL #	STOCK #	DESCRIPTION	OVERALL DIMENS. (OUTSIDE: L x W x D)	PACKED
20220-2	6701VU	Includes (2) T220 & T221 Boxes	9-3/4" x 8-3/4" x 1-1/2" (24.77 x 22.23 x 3.81 cm)	6/ctn
6701NB	6701NB	Frame Only	9-3/4" x 8-3/4" x 1-1/2" (24.77 x 22.23 x 3.81 cm)	6/ctn
21210-2	6709VU	Includes (2) T210 & T215 Boxes	14-1/4" x 10-3/4" x 1-1/2" (36.20 x 27.31 x 3.81 cm)	6/ctn
6709NB	6709NB	Frame Only	14-1/4" x 10-3/4" x 1-1/2" (36.20 x 27.31 x 3.81 cm)	6/ctn
21600-2	6728VU	Includes (2) T612 & T618 Boxes	13-7/16" x 13-1/2" x 2-1/8" (34.13 x 34.29 x 5.40 cm)	6/ctn
6728NB	6728NB	Frame Only	13-7/16" x 13-1/2" x 2-1/8" (34.13 x 34.29 x 5.40 cm)	6/ctn



21210-2 folded and side view



For Customer Service Inquiries Call: 1(800) 344-5716



Specialty Storage: Stand 'N Store™

A cross between a tool box and a step stool, the Stand 'N Store™ makes a great companion for tool portability and that often needed "little extra reach" on any job site.

Features:

- Engineered to support 300 pounds (136.08 kg)
- Heavy-duty riveted fold-down handle
- Lift-out center tray

They're Stackable!



Side View



22500-3

MODEL #	STOCK #	DESCRIPTION	DIMENS. (INSIDE: L x W x D)	TRAY DIMENSIONS (L x W x D)	PACKED
22500-3	6759TC	Safety Yellow	15-1/2" x 9.0" x 7-1/2" (39.37 x 22.86 x 19.05 cm)	14.0" x 8-1/4" x 1-5/8" (35.56 x 20.96 x 4.13 cm)	2/ctn

Expandable Tube

Features:

- Contoured, blow molded construction - won't bend, crush or break
- Hinged door makes it easy to load and unload
- Molded-in handle for maximum durability
- Completely lockable for added security
- Telescopes from 63" (160.02 cm) to 87" (220.99 cm) for maximum versatility



50077

MODEL #	STOCK #	DESCRIPTION	DIMENS. (OUTSIDE: L x W x D)	TELESCOPE RANGE	PACKED
50077 	50077	Black, Expandable Tube	5.0" Diameter, 63" Collapsed (12.70 Dia., 160.02 cm)	63.0" to 87.0" (160.02 to 220.99 cm)	1/ctn

Specialty Storage: Parts Station™ Storage Cabinets

High-density storage, maximum organization and cost savings efficiency can be achieved with our generous selection of reinforced durable plastic frame storage cabinets. Each drawer cabinet features terpolymer translucent drawers and drawer stops to prevent accidental spills.

*All cabinets include (10) 35/52 dividers, all other dividers are optional

MODEL #	STOCK #	DESCRIPTION	USES DRAWER #	USES DIVIDER #	DIMENS. (OUTSIDE: L x W x H)	PACKED
C20P	6575PC	Gray Clear Terpolymer Drawers Clear Terpolymer Dividers	(15) TW (4) TQ (1) TF	* (10) 35/52 50/64 57/275	12.0" x 6-1/4" x 11-1/4" (30.48 x 15.88 x 28.58 cm)	4/ctn
C26P	6576PC	Gray Clear Terpolymer Drawers Clear Terpolymer Dividers	(15) TW (8) TQ (2) TJ (1) TF	* (10) 35/52 50/64 57/135 57/275	12.0" x 6-1/4" x 16-1/2" (30.48 x 15.88 x 41.91 cm)	4/ctn
U30P	6573PC	Gray / Clear Terpolymer Drawers Clear Terpolymer Dividers	(30) TW	* (10) 35/52	12.0" x 6-1/4" x 11-1/4" (30.48 x 15.88 x 28.58 cm)	4/ctn
U45P	6574PC	Gray / Clear Styrene Drawers Clear Styrene Dividers	(45) TW	* (10) 35/52	12.0" x 6-1/4" x 16-1/2" (30.48 x 15.88 x 41.91 cm)	4/ctn



C20P



C26P



U30P



U45P

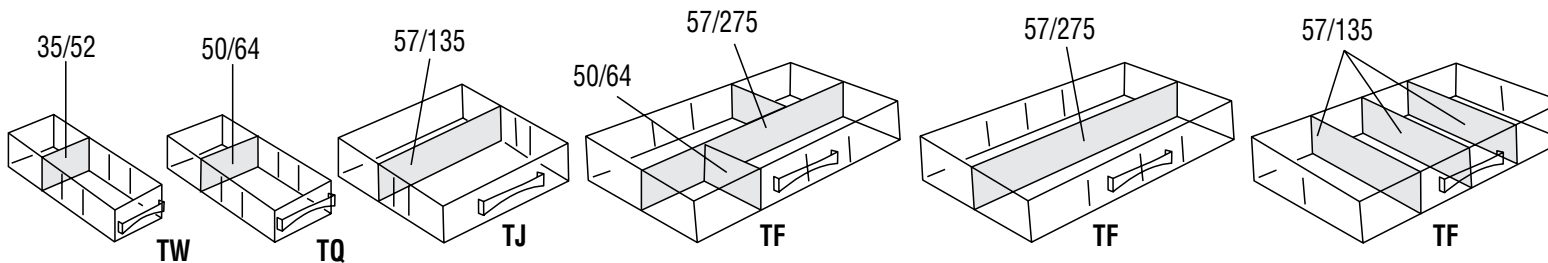

Drawers

Dividers

MODEL #	STOCK #	DESCRIPTION	DIMENS. (INSIDE: L x W x H)	PACKED	MODEL #	STOCK #	DESCRIPTION	DIMENS. (INSIDE: L x W x H)	PACKED
TW	6062DP	Uses (3) 35/52 Dividers, (dividers sold separately)	2.0" x 5-3/8" x 1-3/8" (5.08 x 13.65 x 3.49 cm)	6/pk	35/52	6770DV	Divider fits Drawer TW, divider wall thickness 1/16" (1.59 cm)	2.0" x 1-1/4" x 1/8" (5.08 x 3.18 x 0.32 cm)	48/pk
TQ	6063DP	Uses (3) Dividers, (dividers sold separately)	2-1/2" x 5-3/8" x 2-1/4" (6.35 x 13.65 x 5.72 cm)	6/pk	50/64	6775DV	Divider Fits Drawer TQ-C & TF-C, Divider Wall Thickness 1/16" (1.59 cm)	2-1/2" x 5-3/8" x 2-1/4" (6.35 x 13.65 x 5.72 cm)	24/pk
TJ	6066DP	Uses (3) Dividers, (dividers sold separately)	5-3/8" x 5-3/8" x 2-1/4" (13.65 x 13.65 x 5.72 cm)	6/pk	57/135	6778DV	Divider Fits Drawer TF-C & TJ-C, Divider Wall Thickness 1/16" (1.59 cm)	5-3/8" x 5-3/8" x 2-1/4" (13.65 x 13.65 x 5.72 cm)	12/pk
TF	6068DP	Uses (3) 57/135 or (1) 57/275 or (1) 57/275 & (6) 50/64 Dividers, (dividers sold separately)	10-7/8" x 5-3/8" x 2-1/4" (27.62 x 13.65 x 5.72 cm)	6/pk	57/275	6779DV	Divider Fits Drawer TF-C, Divider Wall Thickness 1/16" (1.59 cm)	10-7/8" x 5-3/8" x 2-1/4" (27.62 x 13.65 x 5.72 cm)	6/pk

Specialty Storage: Utility Workstation™ Cart

Stress tested for weight up to 300 pounds (136.08 kg) you can easily integrate this cart into almost any application. Many other Flambeau products can be integrated into this Workstation to increase your organization & efficiency. Can be customized with your company name or logo.

Features:

- Locking tabs for lid
- Sliding removable lid
- Customizable logo area
- Heavy-duty locking casters - holds up to 300 lbs (136.08 kg)
- Lockable lid compartment
- Drain plugs (each tray)
- Bin rail
- Ergonomic handle with tool receiver

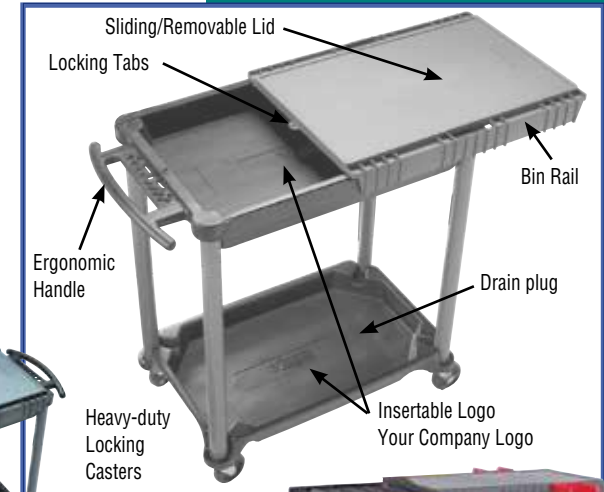

MODEL #	STOCK #	DESCRIPTION	OVERALL DIMENSIONS (L x W x D)	PACKED
8510ST	8510ST	Two-Tone Gray	43.0" x 22.0" x 39.0" (109.22 x 55.55 x 99.06 cm)	1/ctn

DIMENS. (INSIDE TRAY: L x W x D)	DIMENS. (BOTTOM TRAY: L x W x D)	DIMENS. (WORK SURFACE: L x W)	LOGO AREA
25-1/2" x 18.0" x 3-5/25" (64.77 x 45.72 x 8.13 cm)	20.0" x 17.0" x 3.0" (50.80 x 43.18 x 7.62 cm)	28-1/2" x 7-1/2" (72.39 x 19.05 cm)	14.0" x 3-1/4" (35.56 x 8.25 cm)

Bin Storage Systems

Mix and match our four (4) sizes of bins to your liking. Our polypropylene bins are extra heavy-duty and can be stacked or wall-mounted with a rail. Our bins are impervious to rust, oil and most common chemicals.

Features:

- Stackable & mountable
- Can be used with the Utility Workstation™ (see above)

Black Bins pictured are made from a conductive material and are located in the Conductive Section of this catalog on [page 115](#)

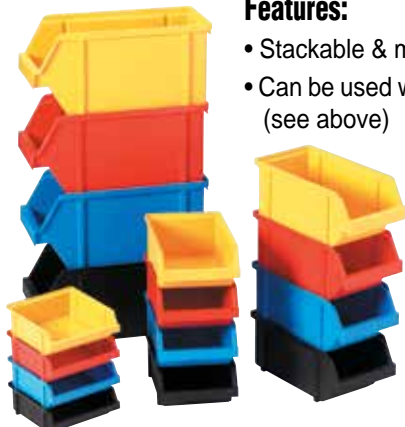

MODEL #	STOCK #	DESCRIPTION	DIMENS (INSIDE L x W x D)	PACKED
60R	6794RB	Red	4-1/4" x 4.0" x 1-1/2"	24/ctn
60B	6794BB	Blue	(10.80 x 10.16 x 3.81 cm)	
60Y	6794YB	Yellow		
120R	6795RB	Red	4-1/4" x 5.0" x 2-1/2"	24/ctn
120B	6795BB	Blue	(10.80 x 12.70 x 6.35 cm)	
120Y	6795YB	Yellow		
240R	6796RB	Red	4-1/4" x 6-1/2" x 3-1/4"	12/ctn
240B	6796BB	Blue	(10.80 x 16.51 x 8.26 cm)	
240Y	6796YB	Yellow		
480R	6797RB	Red	4-1/4" x 8-3/4" x 5-1/4"	12/ctn
480B	6797BB	Blue	(10.80 x 22.23 x 13.34 cm)	
480Y	6797YB	Yellow		
351BA	6794BA	Set of (16) 60Y, (24) 120R, (24) 120R, (24) 240Y & (16) 480B	See Individual Bin Sizes	1/ctn

* Width is measured from back to front straight edge before flare out

Specialty Storage: Rolling Tote Storage Cabinet

The Rolling Tote is designed for light commercial parts storage and transport. Excellent for storing and transporting hand held tools, MRO items, or single unit storage for multiple uses. Features side extension pull handle with grip and lift out removable tray including lid stays. The large interior storage area, approx. 31" X 20" provides ample area to organize.

Features:

- Includes removable tray
- Padded steel pull handle for easy transport
- Lid can be used as a work surface
- Weight: 23.0 lbs per carton / cu /carton: 6-3/4" (17.14 cm)

Great for outdoor gear and more!



Lid can be used as a work surface



Can hold level and square
(Level & square are not included)

Includes removable tray

Padded steel pull handle for easy transport



MODEL #	STOCK #	DESCRIPTION	DIMENS. (INSIDE: L x W x D)	DIMENS. (OUTSIDE: L x W x D)	PACKED
6531BK	6531BK	Black w/Metal Latches	25.0" x 13-3/4" x 15-3/4" (63.5 x 34.92 x 40.0 cm)	29-1/2" x 18-1/2" x 19-1/2" (74.93 x 47.0 x 49.53 cm)	1/ctn



For Customer Service Inquiries Call: 1(800) 344-5716



Zerust® Bags New!



The new yellow Zerust® bags are designed to protect and prevent firearms from rusting during storage up to 5 years. Now available in a pistol and rifle size bag, simply place the firearm into the bag and let the protection begin! **(See page 4 for more info on Zerust)**

9" x 12" Pistol Zerust® Bag

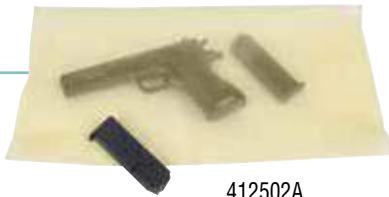

412502A

10" x 54" Rifle Zerust® Bag



412501A

Stop Rust Gun Plug

Designed to protect valuable firearms up to 5 years from rusting during storage. Simply insert plug into barrel of gun & let the protection begin!



The **Stop Rust Gun Plug** fits firearms ranging from .22 caliber to a 28 gauge shotgun

MODEL #	STOCK #	DESCRIPTION	DIMENSIONS (L x W x D)	PACKED
6647ZR	6647ZR	Yellow Plug Molded w/Zerust	3.0" (7.62 cm)	12/ctn
412502A	412502A	Yellow Translucent Zerust Bag	9.0" x 12.0" (22.86 x 30.48 cm)	12/ctn
412501A	412501A	Yellow Translucent Zerust Bag	10.0" x 54.0" (25.4 x 137.16 cm)	12/ctn

Specialty Storage: Protective Gun Cases

Protects your guns from bumps and bruises while preventing unwanted trespassers into the case. The guns are blanketed with egg-shell foam, two locking points and piano style hinge to prevent opening during transport.

Specialty Storage

Pistol Pack Series

- Contemporary high profile design
- Sliding, lockable latches
- Full egg-shell foam
- Stackable



MODEL #	STOCK #	DESCRIPTION	DIMENSIONS (L x W x D)	PACKED
6776TC	6776TC	10-1/2" Black	10-1/2" x 8.0" x 3-1/8" (26.67 x 20.32 x 7.94 cm)	14/ctn
6781TC	6781TC	14.0" Black	14.0" x 11.0" x 3-1/4" (35.56 x 27.94 x 8.26 cm)	14/ctn
6785TE	6785TE	17.0" Black	17.0" x 11.0" x 3-1/4" (43.18 x 27.94 x 8.26 cm)	6/ctn

Economy Single Gun Case

- Largest economy single available
- Four locking points and piano style hinge
- Durable egg-shell foam



MODEL #	STOCK #	DESCRIPTION	DIMENSIONS (L x W x D)	PACKED
6470SS	6470SS	Black w/Egg-Shell Foam	53-5/8" x 12-1/8" x 3-3/4" (136.20 x 30.79 x 9.53 cm)	1/ctn

Patent # D486,637

Single Gun Case

- Four locking points for extra security
- Combination of piano style hinge and brass hinge provide durability, safety and protection
- Oversized single fits most scoped rifles
- Durable egg-shell foam



MODEL #	STOCK #	DESCRIPTION	DIMENSIONS (L x W x D)	PACKED
6489NK	6489NK	Black w/Egg-Shell Foam	53-1/2" x 13-1/2" x 4-1/2" (135.89 x 34.29 x 11.43 cm)	2/ctn

Patent # D486960

Double Gun Case

- Four locking points for extra security
- Combination of piano style hinge and brass hinge provide durability, safety and protection
- Oversized double will accommodate two scoped rifles
- Durable egg-shell foam



MODEL #	STOCK #	DESCRIPTION	DIMENSIONS (L x W x D)	PACKED
6499NK ©	6499NK	Black w/Egg-Shell Foam	53-3/8" x 16-1/2" x 4-1/2" (136.20 x 41.91 x 11.43 cm)	1/ctn

Patent # D486960



For Customer Service Inquiries Call: 1(800) 344-5716



Small Tactical Case

Store more in one! The Small Tactical Case, a.k.a. Double Deep case, features a deep, 6" base for extra storage, 4 pad lock holes, 2 tough snap-fit latches and an integral off-set handle for easier transport. Rugged, stackable and extremely durable, this case is suitable for tool storage, camera equipment, fire-arms, emergency kits, along with many more functions.

Convolute foam option on lid and base



6791DDC

- 2 Layers of foam in base:
 - Convolute foam
 - Diced foam

Medium Tactical Case

The only case in the market that features a distinctive 32" length. The Medium Tactical Case can store and protect any valuables featuring a 5" depth, optional interchangeable divider compartments, 4 tough snap-fit latches and 4 pad lock holes for greater security. Stackable with high impact copolymer polypropylene walls, this rugged case provides durability for the toughest transport.



6505PDW

Customize Cases with Your name/company

Optional interchangeable divider compartments

Large Tactical Case

- Four locking points for extra security
- Durable egg-shell foam
- Four magazine pockets
- Adjustable strap option
- Integral handle for easy transport
- Mechanical style hinge for added durability



6500ARP

NOTE: Cases made of high impact co-polymer polypropylene material.

MODEL #	STOCK #	DESCRIPTION	DIMENSIONS (L x W x D)	PACKED
6791DDC	6791DDC	Small Tactical, 2 Layers of Foam: Diced on Bottom, Convolute on Top & Lid	16-1/4" x 12.0" x 5-1/2" (41.28 x 30.48 x 13.97 cm)	6/ctn
6792DDC	6792DDC	Small Tactical No Foam	16-1/4" x 12.0" x 5-1/2" (41.28 x 30.48 x 13.97 cm)	6/ctn
6505PDW	6505PDW	Medium Tactical, Convolute Foam in Base & Lid With 2 Straps & Dividers	31-4/5" x 11-2/5" x 5.0" (80.82 x 28.93 x 12.70 cm)	1/ctn
6506PDW	6505PDW	Medium Tactical, No Foam	31-4/5" x 11-2/5" x 5.0" (80.82 x 28.93 x 12.70 cm)	1/ctn
6500ARP	6500ARP	Black w/Egg-Shell Foam With 2 Straps and Dividers	40.0" x 12.0" x 4.0" (101.60 x 30.48 x 10.16 cm)	1/ctn



Tactical Case Family

Linesman Case New!

The New Linesman Case is very unique yet versatile. This 43 inch long case is designed for multiple storage applications---long and deep enough to store and protect everything from fishing rods to small rifles, and everything in-between. The ergonomic offset handle helps balance the heaviest loads during transport. The Linesman Case is built tough with steel pin hinge construction, tough ABS latches, four locking points, and conveniently stacks for optimum storage

Features:

- Deep 6" base
- Steel pin hinge construction
- Ergonomic off-set handle
- 4 Locking points
- Tough ABS latches



7450AP



7450BG

8 Pistol Linesman Case

Finally a case large enough to hold your firearm collection! Protected with foam, the pistols sit vertically along the 42 inch case with easy access to the grips. The flexible foam allows for any size pistol to fit nicely in the slot. There's even enough room for an extra magazine next to each pistol

Optional Custom Foam Interiors



Diced foam interior

The deep 6 inch base leaves enough room for multiple custom options like diced foam or die-cut foam to store and protect your valuables (minimum order quantities apply).



MODEL #	STOCK #	DESCRIPTION	DIMENSIONS (L x W x D)	PACKED
7450AP	7450AP	Stock - No Foam	40.0" x 9-1/2" x 6.0" (101.63 x 24.05 x 15.24 cm)	1/ctn
7450BG	7450BG	8 - Pistol Foam	40.0" x 9-1/2" x 6.0" (101.63 x 24.05 x 15.24 cm)	1/ctn



For Customer Service Inquiries Call: 1(800) 344-5716



Waterproof Satchels New!

The new Waterproof Satchels feature a thick durable wall construction with a 360 degree seal for water resistance. Available in two sizes, these satchels feature two locking points for extra security, a rubber over molded handle for easy carry, a recessed lid for extra work space, rust proof steel pin hinge construction, and a durable polycarbonate lid with ribbing design providing extra strength for crush resistance. The open core interior can be custom molded or inserted with die-cut foam to safely store and protect your valuables.

Features:

- Locking points
- Over mold handle
- Snap-shut latches
- Rubber seal
- Ribbing design for extra strength
- Steel pin hinge construction
- Recessed lid for work space
- Durable polycarbonate lid
- Stacking feature



Rubber Seal
(shown on clear for illustration purposes)



Locking Point



MODEL #	STOCK #	DESCRIPTION	DIMENSIONS (L x W x D)	BASE	LID	PACKED
3000WPOC	3000WPOC	Waterproof Satchel 3000	12-3/4" x 9-2/3" x 4-1/5" (31.97 x 24.28 x 10.56 cm)	2-1/2"	1-3/5"	2/ctn
4000WPOC	4000WPOC	Waterproof Satchel 4000	16-1/5" x 11-1/3" x 6-3/4" (41.17 x 28.70 x 17.17 cm)	4-7/8"	1-7/8"	2/ctn

The HD Case Series New!

The only family this size that is 100% waterproof with rubber interior liners, steel pin hinge construction, thick ribbed walls for high impact resistance and an adjustable pressure release valve for airline transit. Available in four popular sizes, these cases are great for photography equipment, flashlight storage, firearm and ammunition storage, electrical equipment, microphone & audio equipment, video game consoles, along with many more! These waterproof cases offer an extremely competitive choice for demanding applications.

Features:

- Black latches with blank logo plate
 - Snap-Shut latches and thick grip handle
 - Rolling wheels and 3 carry/pull handles
 - Metal protected latching points
 - Thick, ribbed walls for durability
 - Waterproof air-tight seal
 - Airline ready with pressure screw
- (Models 4213AW and 5213AW only)*



HD Case Series

MODEL #	STOCK #	DESCRIPTION	DIMENSIONS (L x W x D)	PACKED
1109AW	1109AW	Small HD Case Black	11-3/4" x 9.0" x 5.0" (29.85 x 22.86 x 12.70 cm)	2/ctn
1410AW	1410AW	Medium HD Case Black	16.0" x 13.0" x 7.0" (40.64 x 33.02 x 17.78 cm)	2/ctn
4213AW	4213AW	Large HD Case Black	42.0" x 13-1/2" x 5.0" (106.68 x 34.29 x 12.70 cm)	1/ctn
5213AW	5213AW	XLarge HD Case Black	50.5" x 13-1/2" x 5.0" (128.27 x 34.29 x 12.70 cm)	2/ctn

XLarge HD Case

3 Carry/Pull Handles



5213AW



Rolling Wheels

Large HD Case



4213AW

Customize Cases with
Your name/company

Medium HD Case



1410AW

Small HD Case



1109AW



For Customer Service Inquiries Call: 1(800) 344-5716



Medical: Maximum Versatility - Built to Last!

Our medical line is light-weight, rust-proof, scratch and chemical-resistant. Flambeau® medical cases, chests, and instrument boxes are built to last with extra thick walls for long-lasting durability and impact resistance. Used by EMS personnel, first-responders, triage staff & other respected medical professionals around the globe, our variety of products will meet your needs

Features:

- Autoclave safe (select items)
- Locking tabs (select items)
- Positive contact cam-over latches
- Thick wall construction
- Rust-proof hinges
- Heavy-duty riveted fold-down handles
- Heavy-duty cantilever stays

Paramedic Gear Box

Features:

- Lockable with a heavy-duty large comfort handle
- Top compartment "U" shaped 1" (2.54 cm) deep
- Positive-touch, double-latch system (top storage area)



Lift-out tray has a center handle



360° Water Resistant: features a water-tight seal

PM1408

MODEL #	STOCK #	DESCRIPTION	DIMENS. (INSIDE: L x W x D)	TRAY DIMENSIONS (L x W x D)	INSIDE CLEARANCE UNDER TRAY (L x W x D)	PACKED
PM1408	6430PM	Orange w/Lift-Out Tray	13.0" x 6-3/4" x 7-1/4" (33.02 x 17.15 x 18.42 cm)	12-3/4" x 6-1/2" x 2.0" (32.39 x 16.51 x 5.08 cm)	5-1/4" (13.33 cm)	4/ctn

Paramedic Case

Our most complete Paramedic cases yet! These cases combine bulk storage with compartments to give you the convenience and flexibility you need.

Features:

- Includes (4) 6004R, & (2) T2003 removable Tuff Tainer® boxes*
- Interior slotted to hold an additional (3) removable, T2003 Tuff Tainer boxes

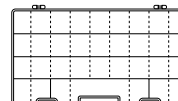
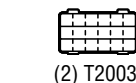

MODEL #	STOCK #	DESCRIPTION	DIMENS. (INSIDE: L x W x D)	BULK STORAGE (L x W x D)	PACKED
PM7040	6049PM	Orange	14.0" x 8-1/2" x 3-1/4" (35.56 x 21.59 x 8.26 cm)	14.0" x 8.0" x 4.0" (35.56 x 20.32 x 10.16 cm)	2/ctn
PM8040	6778PM	Orange	17.0" x 11.0" x 3-1/2" (43.18 x 27.94 x 8.89 cm)	18.0" x 11.0" x 4.0" (45.72 x 27.94 x 10.16 cm)	2/ctn

* Tuff Tainers are adjustable compartmented boxes; For dimensions of: T2003 (page 30), T6004 (page 32), T4007E (page 31), T4000 (page 31), & T1002 (page 30)

Medical: First Aid Cases



PM1702

Includes lift-out tray



PM1772



PM1872

MODEL #	STOCK #	DESCRIPTION	DIMENS. (INSIDE: L x W x D)	TRAY DIMENSIONS (L x W x D)	PACKED
PM1702	6768PM	Orange w/White Tray 1 Compartment & Removable Tray	15.0" x 6-3/4" x 6-1/2" (38.10 x 17.15 x 16.51 cm)	14-3/8" x 6-5/8" x 2.0" (36.51 x 16.83 x 5.08 cm)	4/ctn
PM1772	6770PM	Orange w/White Trays 2 Tip-Proof Cantilever Trays, 8 Large Compartments	15.0" x 6-3/4" x 6-1/2" (38.10 x 17.15 x 16.51 cm)	14-1/4" x 5-3/4" x 1-3/8" (36.20 x 14.61 x 3.49 cm)	4/ctn
PM1872	6772PM	Orange w/White Trays 2 Tip-Proof Cantilever Trays, 8 Large Compartments	15-5/8" x 6-1/2" x 7-3/4" (39.39 x 16.51 x 19.69 cm)	14-3/4" x 7-1/8" x 1-3/4" (37.47 x 18.10 x 4.45 cm)	4/ctn



Paramedic Box

The standard in emergency care cases.

- Lockable
- Heavy-duty trays - riveted cantilever rust-resistant hardware



PM2072



MODEL #	STOCK #	DESCRIPTION	DIMENS. (INSIDE: L x W x D)	TRAY DIMENSIONS (L x W x D)	PACKED
PM2072	6774PM	Orange w/White Trays 2 Tip-Proof Cantilever Trays, 10 Large Compartments	17-1/8" x 9-1/2" x 5.0" (43.50 x 24.13 x 12.70 cm)	14-3/8" x 6-5/8" x 2.0" (36.51 x 16.83 x 5.08 cm)	1/ctn



For Customer Service Inquiries Call: 1(800) 344-5716



Medical: Command Center Box

Excellent for bulk storage. With two built-in handles on each end, this box gives you the flexibility and ease of quick transport from your vehicle to the scene. This box is durable, but light-weight and has become a favorite!

Features:

- Lockable with 2 power latches



PM2780

MODEL #	STOCK #	DESCRIPTION	DIMENS. (INSIDE: L x W x D)	REMOVABLE TRAY DIMENS (L x W x D)	PACKED
PM27800	6754PM	Orange w/Lift-Out Tray	23.0" x 12-1/2" x 12.0" (58.42 x 31.75 x 30.40 cm)	12.0" x 11-3/4" x 2.0" (30.48 x 29.85 x 5.08 cm)	2/ctn

Trauma Drug Kits

Our trauma drug kits have a drop-front panel for easy access to the storage bin below, a positive cam-over latch, and are lockable for protection of contents. The ABS drawers can be sterilized. All drawers are removable and interchangeable.



PM2272

PM2273

MODEL #	STOCK #	DESCRIPTION	DIMENS. (OUTSIDE: L x W x D)	* DRAWER CONFIGURATIONS (see page 109)	PACKED
PM2272	6776PM	Orange w/White Drawers, 27 Compartments	19-1/2" x 11-1/2" x 11-3/4" (49.53 x 29.21 x 29.85 cm)	(1) B & (1) C	1/ctn
PM2273	6777PM	Orange w/White Drawers, 53 - 65 Compartments	19-1/2" x 11-1/2" x 11-3/4" (49.53 x 29.21 x 29.85 cm)	(3) B	1/ctn

Medical: Drawer Cabinets

Our drawer cabinets feature a front panel that easily drops down and provides access to the drawers inside. The front panel also features a lockable latch for extra security. ABS drawers can be sterilized and are removable, as well as interchangeable.



PM2274

PM2275

MODEL #	STOCK #	DESCRIPTION	DIMENS. (OUTSIDE: L x W x D)	* DRAWER CONFIGURATIONS (see below)	PACKED
PM2274	6762PM	Orange w/White Drawers, 27 Compartments	19-1/2" x 10-3/8" x 15.0" (49.53 x 26.35 x 38.10 cm)	(1) A, (1) C, (1) D & (1) E	1/ctn
PM2275	6763PM	Orange w/White Drawers, 53 - 65 Compartments	19-1/2" x 10-3/8" x 15.0" (49.53 x 26.35 x 38.10 cm)	(2) B, (2) D & (1) E	1/ctn

Trauma Drug Kits and Drawer Cabinets Drawer Dimensions



Drawer A (#AR839-10):

L = 15-9/16" (39.53 cm),
W = 8-13/16" (22.84 cm),
D = 1-3/8" (3.49 cm)

Drawer A Compartments (L x W x D):

A = 1-15/16" x 6-3/16" x 1-1/4" (4.92 x 15.72 x 3.18 cm),
B = 7-5/16" x 6-3/16" x 1-1/4" (18.57 x 15.72 x 3.18 cm),
B = 15-1/8" x 2-7/16" x 1-1/4" (5.08 x 7.94 x 3.18 cm)

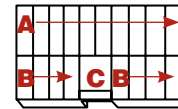

Drawer D (#AR840-10):

L = 15-9/16" (39.53 cm),
W = 8-13/16" (22.84 cm),
D = 1-3/8" (3.49 cm)

Drawer D Compartments (L x W x D):

A = 1-3/8" x 5-1/16" x 1-1/4" (3.49 x 12.86 x 3.18 cm),
B = 1-3/8" x 3-9/16" x 1-1/4" (3.49 x 9.05 x 3.18 cm),
C = 3-3/16" x 3-9/16" x 1-1/4" (8.10 x 9.05 x 3.18 cm)



Drawer B (#AR841-10):

L = 15-9/16" (39.53 cm),
W = 8-13/16" (22.84 cm),
D = 1-3/8" (3.49 cm)

Drawer B Compartments (L x W x D):

A = 1-15/16" x 4-1/2" x 1-1/4" (4.92 x 11.43 x 3.18 cm),
B = 3-3/16" x 8-7/8" x 1-1/4" (8.10 x 22.54 x 3.18 cm)



Drawer E (#AR928-10):

L = 15-9/16" (39.53 cm),
W = 8-13/16" (22.84 cm),
D = 4-7/16" (11.27 cm)

Drawer E Compartments (L x W x D):

A = 15-1/8" x 8-5/8" x 4-5/16" (38.42 x 21.91 x 10.95 cm)



Drawer C (#AR869-10):

L = 15-9/16" (39.53 cm),
W = 8-13/16" (22.84 cm),
D = 2-7/8" (7.30 cm)

Drawer C Compartments (L x W x D):

A = 15-1/8" x 8-5/8" x 2-5/8" (38.42 x 21.91 x 6.67 cm)

To order replacement drawers, please call Customer Service: 1-800-344-5716. Be sure to give them the Drawer letter (A, B, etc.) and number listed after "#" in this section for easier ordering.



For Customer Service Inquiries Call: 1(800) 344-5716





**Withstands Autoclaving
and Sterilization!**



Medical: Instrument Boxes

Ideal for small or delicate equipment.

Features:

- Integral hinge
- Positive latch
- Durable polypropylene construction
- Safe for autoclaving



V301



V301PT



V401



V401D-2



V501



V601



V701

MODEL #	STOCK #	DESCRIPTION	DIMENS. (INSIDE: L x W x D)	PACKED
V301	6142VB	Orange, 1 Compartment w/Hanging Tag	7.0" x 3-1/4" x 1.0" (17.78 x 8.26 x 2.54 cm)	36/ctn
V301PT	6650VC	Taupe, 1 Compartment	7.0" x 3-1/4" x 1.0" (17.78 x 8.26 x 2.54 cm)	36/ctn
V401	6152VB	Taupe, 1 Compartment	8-1/8" x 4-1/8" x 1-3/16" (20.64 x 10.48 x 3.02 cm)	24/ctn
V401D-2	6654DV	Taupe, 1 Deep Compartment	8-1/8" x 4-1/8" x 2-5/8" (20.64 x 10.48 x 6.03 cm)	24/ctn
V501	6160VB	Taupe, 1 Compartment	10.0" x 4-1/4" x 1-1/2" (25.40 x 10.80 x 3.81 cm)	24/ctn
V601	6667VB	Taupe, 1 Compartment	13-1/2" x 5-3/4" x 2.0" (34.29 x 14.61 x 5.08 cm)	12/ctn
V701	6172VB	Taupe, 1 Compartment	17.0" x 7-1/8" x 2.0" (43.18 x 18.10 x 5.08 cm)	6/ctn

Medical: Medical Device Box

Store, transport, and protect cardiac implant devices and most other small wafer type implantable devices. Sterilize with ETO; Gamma; or E-Beam process. Made of tough Polypropylene material. Box can be easily customized with logo or name plate.



6528MD

MODEL #	STOCK #	DESCRIPTION	DIMENS. (INSIDE: L x W x D)	TRAY DIMENSIONS (L x W x D)	PACKED
6528MD	6528MD	Natural	5-3/10" x 5-3/10" x 1-1/2" (13.46 x 13.46 x 3.81 cm)	5-3/10" x 5-3/10" x 1-1/2" (13.46 x 13.46 x 3.81 cm)	24/ctn

Medical: ScriptSafe® Case

ScriptSafe® is a heavy-duty plastic carrying case with patent locking features designed to safely store and help secure prescription medications. Two of the three configurations feature a “cam-actuated” locking mechanism which locks the case down—while the contents inside remain locked.

Features:

- Steel hinge pin construction
- Tamper resistant hinge segments
- Patented “Lockdown” features (models 6526MD & 6527MD)
- Includes 2 keys



Designed to safely store prescription medications from inquisitive eyes.



6525MD



Short Axle Lockdown Feature

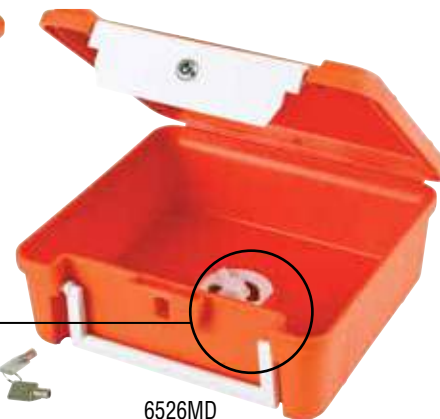

6526MD



Tall Axle Lockdown Feature



6527MD

Patent # 8695386

MODEL #	STOCK #	DESCRIPTION	DIMENS. (INSIDE: L x W x D)	PACKED
6525MD	6525MD	Orange, Open Core w/Out Lockdown Feature	8-1/2" x 7-1/8" x 2-3/4" (21.59 x 18.10 x 6.99 cm)	12/ctn
6526MD	6526MD	Orange, Open Core w/Lockdown Feature	8-1/2" x 7-1/8" x 2-3/4" (21.59 x 18.10 x 6.99 cm)	12/ctn
6527MD 	6527MD	Orange, Divided Core w/Lockdown Feature	8-1/2" x 7-1/8" x 2-3/4" (21.59 x 18.10 x 6.99 cm)	12/ctn



For Customer Service Inquiries Call: 1(800) 344-5716



Conductive: Guard Against Expensive Damage

A leader in the industry, Flambeau's reusable conductive product line significantly reduces electrical resistance and provides an extremely high permanent level of conductivity to dissipate static charge build-up, alleviating electrostatic discharge (ESD). Our proprietary blend of carbon loaded HDPE materials are a guarantee that Flambeau conductive products will protect the most sensitive equipment and perform in the harshest environment.

Technical Data:

- Surface Resistivity 1010-1011 (ASTM D 257 / ESD S11.11)
- Static Decay <2.0 Seconds (MIL-PRF-81705D)

Features:

- Double-wall Construction - Maximum Physical Protection
- Locking Tabs (select items)
- Secure Positive, Integral Double Latches
- ESD Protection
- Reusable & Stackable
- Permanently Anti-Static

Conductive Cases

Options:

- Clear Conductive Window (Special order styles only)
 - Easy part identification without compromise of Faraday Cage protection
- Grounding Snap
 - Reduces surface charges so the case can be safely opened without damaging contents
- Antistatic or Conductive Foam
 - (Conductive quoted separately)
 - (Antistatic included upon request, foam is glued into case)
 - Provides physical shock resistance, reduces the potential for static build-up and arc potential due to the low friction coefficient of the foam



Die-cut foam quoted separately

MODEL #	STOCK #	DESCRIPTION	DIMENSIONS (INSIDE: L x W x D* *) *B = Base; L = Lid; * *Depth = Base + Lid	PACKED
50019	50019 / 21460	5 x 3 Conductive Case	5-1/16" x 2-3/4" B*, 2-5/8" L* x 1" (13.49 x 6.99 B*, 6.67 L* x 2.54 cm)	341/ctn
21463	21463	6 x 5 Conductive Case	6-3/4" B*, 6-1/2" L* x 5.0" B*, 4-3/4" L* x 1-1/16" (17.15 B*, 16.51 L* x 12.70 B*, 12.07 L* x 3.02 cm)	135/ctn
50014	50014	9 x 7 Conductive Case w/Wire Tie Feature	8-15/16" B*, 9-1/16" L* x 6-5/8" B*, 6-1/2" L* x 1-1/4" (22.70 B*, 23.02 L* x 16.83 B*, 16.51 L* x 3.18 cm)	96/ctn
50015	50015	12 x 8 Conductive Case w/Wire Tie Feature	11-7/8" B*, 11-15/16" L* x 8-3/16" B*, 8-7/16" L* x 1-1/4" (30.16 B*, 30.32 L* x 20.80 B*, 21.43 L* x 3.18 cm)	54/ctn
21458	21458	13 x 11 Conductive Case w/Wire Tie Feature	12-3/4" x 10-1/2" x 1-3/4" (32.39 x 26.67 x 4.45 cm)	30/ctn
21459	21459	15 x 6 Conductive Case	15.0" x 6-1/2" x 2.0" (38.10 x 16.51 x 5.08 cm)	24/ctn
21462	21462	18 x 14 Conductive Case w/Wire Tie Feature	17-1/2" x 13-1/2" x 1-5/16" (44.45 x 34.29 x 3.33 cm)	7/ctn
21461	21461	18 x 18 Conductive Case w/Wire Tie Feature	18-7/16" x 17-11/16" x 1-15/16" (46.83 x 44.93 x 4.92 cm)	10/ctn

Conductive: Conductive Storage Cabinets

High-density storage, maximum organization and cost savings efficiency can be achieved with our generous selection of reinforced durable plastic frame conductive storage cabinets. Each drawer cabinet features conductive drawers and drawer stops to prevent accidental spills.

*All cabinets include (10) 35/52 dividers, all other dividers are optional

MODEL #	STOCK #	DESCRIPTION	USES DRAWER #	USES DIVIDER #	DIMENS. (OUTSIDE: L x W x H)	PACKED
C20P-C	6575CD	Black Black Drawers Black Dividers	(15) TW-C (4) TQ-C (1) TF-C	*(10) 35/52C 50/64C 57/275C	12.0" x 6-1/4" x 11-1/4" (30.48 x 15.88 x 28.58 cm)	4/ctn
C26P-C	6576CD	Black Black Drawers Black Dividers	(15) TW-C (8) TQ-C (2) TJ-C (1) TF-C	*(10) 35/52C 50/64C 57/135C 57/275C	12.0" x 6-1/4" x 16-1/2" (30.48 x 15.88 x 41.91 cm)	4/ctn
U30P-C	6573CD	Black / Black Drawers Black Dividers	(30) TW-C	*(10) 35/52C	12.0" x 6-1/4" x 11-1/4" (30.48 x 15.88 x 28.58 cm)	4/ctn
U45P-C	6574CD	Black / Black Drawers Black Dividers	(45) TW-C	*(10) 35/52C	12.0" x 6-1/4" x 16-1/2" (30.48 x 15.88 x 41.91 cm)	4/ctn



C20P-C



C26P-C



U30P-C



U45P-C

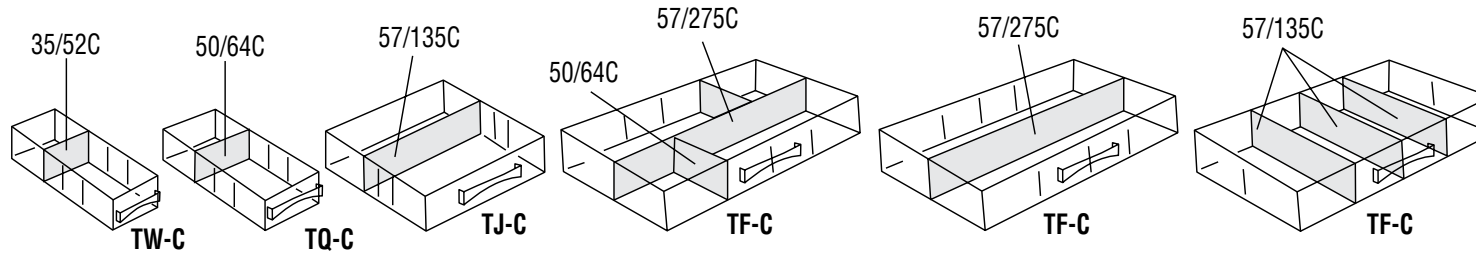

Drawers

Dividers

MODEL #	STOCK #	DESCRIPTION	DIMENS. (INSIDE: L x W x H)	PACKED	MODEL #	STOCK #	DESCRIPTION	D. (INSIDE: L x W x H)	PACKED
TW-C	6061DP	Uses (3) 35/52C Dividers, (dividers sold separately)	2.0" x 5-3/8" x 1-3/8" (5.08 x 13.65 x 3.49 cm)	6/pk	35/52C	6780CD	Divider Fits Drawer TW-C, Divider Wall Thickness 1/16" (1.59 cm)	2.0" x 1-1/4" x 1/8" (5.08 x 3.18 x 0.32 cm)	25/pk
TQ-C	6064DP	Uses (3) 50/64C Dividers, (dividers sold separately)	2-1/2" x 5-3/8" x 2-1/4" (6.35 x 13.65 x 5.72 cm)	6/pk	50/64C	6785CD	Divider Fits Drawer TQ-C & TF-C, Divider Wall Thickness 1/16" (1.59 cm)	2-1/2" x 5-3/8" x 2-1/4" (6.35 x 13.65 x 5.72 cm)	24/pk
TJ-C	6065DP	Uses (3) 57/135C Dividers, (dividers sold separately)	5-3/8" x 5-3/8" x 2-1/4" (13.65 x 13.65 x 5.72 cm)	6/pk	57/135C	6782CD	Divider Fits Drawer TF-C & TJ-C, Divider Wall Thickness 1/16" (1.59 cm)	5-3/8" x 5-3/8" x 2-1/4" (13.65 x 13.65 x 5.72 cm)	12/pk
TF-C	6067DP	Uses (3) 57/135C or (1) 57/275C or (1) 57/275C & (6) 50/64C Dividers, (dividers sold separately)	10-7/8" x 5-3/8" x 2-1/4" (27.62 x 13.65 x 5.72 cm)	6/pk	57/275C	6784CD	Divider Fits Drawer TF-C, Divider Wall Thickness 1/16" (1.59 cm)	10-7/8" x 5-3/8" x 2-1/4" (27.62 x 13.65 x 5.72 cm)	6/pk

Compartment Boxes: Conductive

SIZES

10-1/2" x 6-3/16" x 1-9/16" through 12-3/4" x 8-1/2" x 2-1/8"
(26.67 x 15.72 x 3.97 cm) through (32.39 x 21.59 x 5.40 cm)

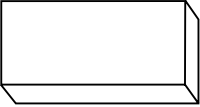
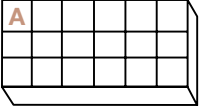
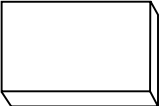
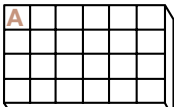
BOX DIAGRAM	MODEL NUMBER	STOCK NUMBER	FAMILY	BOX MATERIAL	DIMENSIONS (INSIDE: L X W X D)	PACKED
 1 Compartment	C601	6707TC	--	Conductive	10-1/2" x 6-3/16" x 1-9/16" (26.67 x 15.72 x 3.97 cm)	24/ctn
 18 Compartments (L x W): A= 1-3/4" x 2-1/16" (4.45 x 5.24 cm)	C618	6714TC	--	Conductive	10-1/2" x 6-3/16" x 1-9/16" (26.67 x 15.72 x 3.97 cm)	24/ctn
 1 Compartment	C801	6734TC	--	Conductive	12-3/4" x 8-1/2" x 2-1/8" (32.39 x 21.59 x 5.40 cm)	12/ctn
 24 Compartments (L x W): A= 2-1/16" x 2-1/16" (5.24 x 5.24 cm)	C824	6726TC	--	Conductive	12-3/4" x 8-1/2" x 2-1/8" (32.39 x 21.59 x 5.40 cm)	12/ctn

* Adding color to the resins effects the clarity of the finished product

Conductive Tool Box

- Storage box with full-length tray



14800-2C



MODEL #	STOCK #	DESCRIPTION	DIMENS. (INSIDE: L x W x D)	TRAY (L x W x D)	PACKED
14800-2C	6744HC	Black	13.0" x 5-3/8" x 4-1/4" (33.02 x 13.65 x 10.80 cm)	12-1/4" x 4-3/4" x 1-1/2" (31.12 x 12.07 x 3.81 cm)	6/ctn

Conductive: 600/800 Series Conductive Boxes



C601



C618

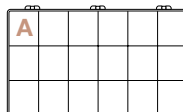

18 Compartments (L x W):
A= 2-1/16" x 1-3/4" (5.24 x 4.45 cm)



C801

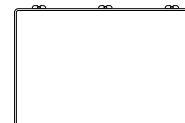

C824

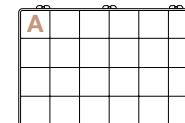

24 Compartments (L x W):
A= 2-1/16" x 2-1/16" (5.24 x 5.24 cm)

MODEL #	STOCK #	DESCRIPTION	DIMENSIONS (INSIDE: L x W x D)	PACKED
C601	6707TC	Black, 1 Compartment	10-1/2" x 6-3/16" x 1-9/16" (26.67 x 15.72 x 3.97 cm)	24/ctn
C618	6714TC	Black, 18 Compartment	10-1/2" x 6-3/16" x 1-9/16" (26.67 x 15.72 x 3.97 cm)	24/ctn
C801	6734TC	Black, 1 Compartment	12-3/4" x 8-1/2" x 2-1/8" (32.39 x 21.59 x 5.40 cm)	12/ctn
C824	6726TC	Black, 24 Compartment	12-3/4" x 8-1/2" x 2-1/8" (32.39 x 21.59 x 5.40 cm)	12/ctn

Conductive Storage Bins



3006C



3007C



3008C



3005C

MODEL #	STOCK #	DESCRIPTION	DIMENSIONS (INSIDE: L x W x D)	PACKED
3006C	6771BC	Black	4-1/4" x 4.0" x 1-1/2" (10.80 x 10.16 x 3.81 cm)	24/ctn
3007C	6772BC	Black	4-1/4" x 5.0" x 2-1/2" (10.80 x 12.70 x 6.35 cm)	24/ctn
3008C	6773BC	Black	4-1/4" x 6-1/2" x 3-1/4" (10.80 x 16.51 x 8.26 cm)	12/ctn
3005C	6774BC	Black	4-1/4" x 8-3/4" x 5-1/4" (10.80 x 22.23 x 13.34 cm)	12/ctn



Stackable!

* Width is measured from back to front straight edge before flare out



For Customer Service Inquiries Call: 1(800) 344-5716



SPECIALTY STORAGE OVERVIEW

Pages 2 - 5

- 2-3 Flambeau Capability Overview
- 4 Zerust® Story and Anti-Tarnish
- 5 Dividers: Zerust, Anti-Tarnish, IDS™ and Generic

**See What's New at Flambeau®**

Pages 6 - 7

- 6 Slim Line™ Boxes, Waterproof Tuff Tainers®, The Aegis Line, Vision 20™, Boxes: 4" x 6", 6" x 6", 12" x 12", 24" x 4",
- 6 Mini and Small Gear Boxes
- 7 Zerust® Bags for Pistol & Rifle, Tactical Series - 2 New Sizes, Lineman Case, Waterproof Satchels and the HD Series

A - SERIES Compartment Boxes

Pages 8 - 15

- 8-9 Sizes: 4-1/4" dia. x 3/4" (10.80 dia. x 1.91 cm) - 6-3/4" x 3-3/16" x 1-3/16" (17.15 x 8.10 x 3.02 cm)
- 10-11 Sizes: 6-3/4" x 3-3/16" x 1-3/16" (17.15 x 8.10 x 3.02 cm) - 8.0" x 4.0" x 1-3/16" (20.32 x 10.16 x 3.02 cm)
- 12-13 Sizes: 8.0" x 4.0" x 1-3/16" (20.32 x 10.16 x 3.02 cm) - 10-1/2" x 6-3/16" x 2-1/4" (26.67 x 15.72 x 5.72 cm)
- 14 Sizes: 10-9/16" x 8-1/4" x 1-9/16" (26.83 x 20.96 x 3.97 cm) - 12-3/4" x 8-1/2" x 2-1/8" (32.39 x 21.59 x 5.40 cm)
- 15 **SLIM LINE™** Sizes: 4.0" x 3-2/5" x 1/2" (17.15 x 8.10 x 1.27 cm) - 6-3/46" x 3-3/16" x 1/2" (17.15 x 8.10 x 1.27 cm)

PRECISION - SERIES Compartment Boxes

Pages 16 - 17

- 16 Sizes: 3-11/16" x 2-9/16" x 13/16" (9.37 x 6.51 x 2.06 cm) - 8-3/4" x 4-5/16" x 1-1/4" (22.23 x 10.95 x 3.18 cm)

DIAMONDBACK™ - SERIES Compartment Boxes

Pages 18 - 21

- 18-19 Sizes: 4-1/2" x 2-11/16" x 1.0" (11.43 x 6.83 x 2.54 cm) - 8-7/16" x 4-1/4" x 1-3/16" (21.43 x 10.80 x 3.02 cm)
- 20-21 Sizes: 8-7/16" x 4-1/4" x 1-3/16" (21.43 x 10.80 x 3.02 cm) - 11.0" x 6-3/8" x 1-9/16" (27.94 x 16.19 x 3.97 cm)

MIGHTY-TUFF™ - SERIES Compartment Boxes

Pages 22 - 23

- 22-23 Sizes: 4-5/16" x 2-5/8" x 1-1/16" (10.95 x 6.67 x 2.70 cm) - 11-15/16" x 5-15/16" x 1-7/16" (30.32 x 15.08 x 3.65 cm)

M - SERIES Compartment Boxes

Pages 24 - 27

- 24-25 Sizes: 4-3/8" x 2-5/8" x 1.0" (11.11 x 6.67 x 2.54 cm) - 10-1/2" x 6-3/16" x 1-9/16" (26.67 x 15.72 x 3.97 cm)
- 26-27 Sizes: 10-1/2" x 6-3/16" x 1-9/16" (26.67 x 15.72 x 3.97 cm) - 12-3/4" x 8-1/2" x 2-1/8" (32.39 x 21.59 x 5.40 cm)

V - SERIES Compartment Boxes

Pages 28 - 29

- 28-29 Sizes: 6-7/8" x 2-1/16" x 1.0" (17.46 x 5.24 x 2.54 cm) - 17.0" x 7-1/8" x 2.0" (43.18 x 18.10 x 5.08 cm)

TUFF TAINER® - SERIES Compartment Boxes

Pages 30 - 33

- 30-31 Sizes: 4-5/16" x 2-5/8" x 1-1/8" (10.95 x 6.67 x 2.86 cm) - 13-11/16" x 8-3/16" x 1-3/4" (34.77 x 20.80 x 4.45 cm)
- 32 Sizes: 13-11/16" x 8-3/16" x 1-3/4" (34.77 x 20.80 x 4.45 cm) - 15-1/4" x 8-7/8" x 3.0" (38.74 x 22.54 x 7.62 cm)
- 33 **WATERPROOF** Sizes: 6-5/8" x 3-9/16" x 1.0" (16.83 x 9.05 x 2.54 cm) - 12-1/2" X 7-1/2" X 2-5/16" (31.75 X 19.05 X 5.88 cm)

K - SERIES Compartment Boxes

Pages 34 - 39

- 34-35 Sizes: 4-3/8" x 2-5/8" x 1.0" (11.11 x 6.67 x 2.54 cm) - 8.0" x 4.0" x 1-3/16" (20.32 x 10.16 x 3.02 cm)
- 36-37 Sizes: 9-5/8" x 6-9/16" x 1-1/2" (24.45 x 16.69 x 3.81 cm) - 12-3/4" x 8-1/2" x 2-1/8" (32.39 x 21.59 x 5.40 cm)
- 38-39 Sizes: 12-3/4" x 8-1/2" x 2-1/8" (32.39 x 21.59 x 5.40 cm)

IDS™ - SERIES Compartment Boxes

Pages 40 - 41

- 40-41 Sizes: 6-5/8" x 3-3/8" x 1-5/16" (16.83 x 8.57 x 3.33 cm) - 13-1/8" x 8-7/8" x 1-15/16" (33.34 x 22.54 x 4.92 cm)

T - SERIES Compartment Boxes

Pages 42 - 45

- 42-43 Sizes: 4.0" x 3-3/8" x 13/16" (10.16 x 8.57 x 2.06 cm) - 10-1/2" x 6-3/16" x 1-9/16" (26.67 x 15.72 x 3.97 cm)
- 44-45 Sizes: 10-1/2" x 6-3/16" x 1-9/16" (26.67 x 15.72 x 3.97 cm) - 13-1/8" x 8-7/8" x 1-15/16" (33.34 x 22.54 x 4.92 cm)

BY SIZE - Of Compartments

Pages 46 - 50

- 46-47 Sizes: 3-11/16" x 2-9/16" x 13/16" (9.37 x 6.51 x 2.06 cm) - 7-1/8" x 5-1/8" x 1-9/16" (18.10 x 13.02 x 3.97 cm)
- 48-49 Sizes: 8.0" x 4.0" x 1-3/16" (20.32 x 10.16 x 3.02 cm) - 11.0" x 6-3/8" x 1-9/16" (27.94 x 16.19 x 3.97 cm)
- 50 Sizes: 11-15/16" x 5-15/16" x 1-7/16" (30.32 x 15.08 x 3.65 cm) - 17.0" x 7-1/8" x 2.0" (43.18 x 18.10 x 5.08 cm)

BY NUMBER - Of Compartments

Pages 51 - 55

- 51-52 (1 - 4) Compts.: Sizes: 3-11/16" x 2-9/16" x 13/16" (9.37 x 6.51 x 2.06 cm) - 13-11/16" x 8-3/16" x 1-3/4" (34.77 x 20.80 x 4.45 cm)
- 53-54 (5 - 12) Compts.: Sizes: 5-5/8" x 2-15/16" x 1-1/8" (14.29 x 7.46 x 2.86 cm) - 8-7/16" x 4-1/4" x 1-3/16" (21.43 x 10.80 x 3.02 cm)
- 55 (12 - 36) Compts.: Sizes: 8-7/16" x 4-1/4" x 1-3/16" (21.43 x 10.80 x 3.02 cm) - 9-5/8" x 6-9/16" x 1-1/2" (24.45 x 16.69 x 3.81 cm)

CASES

Pages 56 - 79

- 56 Flambeau® Tradesman™ Cases
- 57 Merchant™ Cases
- 58 Tradesman™ and Merchant™ Case Options
- 59-60 The Defender® Cases
- 61-62 Infinity™ Cases
- 63-65 The "P" Series: The Pin-Hinge Case
- 66-69 "R" Series Cases
- 70-71 The Aegis Line
- 72-73 Parts and Accessories: Case Handles and Latches
- 74 Black Ribbon™
- 75 Secure-Lock™ Case
- 76 Vision 20™
- 77 4" x 6", 6" x 6", 12" x 12" Boxes and Strip Case
- 78-79 Blow Molded Mailers, Tradesman™ and Beta Case

SATCHEL BOXES

Pages 80 - 83

- 80 Deep and Slim Super Satchel™
- 81 Deluxe Super Satchel™
- 82 Double Deep Super Satchel™ and Satchel-Style Cases: Small
- 83 Satchel-Style Cases: Large

TOOL BOXES

Pages 84 - 93

- 84 Utility Series, Blow Molded Small and Large Tool Boxes
- 85 Utility Boxes
- 86 Utility/Tool Boxes w/Lift-Out Trays and Lock Tabs
- 87 Utility Boxes with Cantilever Trays: 2-Trays and 6-Trays
- 88 Low Boy™ Tool Box, Expandable Building Box and Expansion Kit
- 89 Gear Boxes
- 90 Lil' Brute Tool Box and Utility Tote
- 91 Utility Bench Box and Tool Chests
- 92 Drawer Cabinets
- 93 Cab. Dimensions & Replacement Drawer Pks

SPECIALTY STORAGE

Pages 94 - 103

- 94 Infinite Divider Storage System/Cabinets
- 95 Carry Packs
- 96 Stand 'N Store™, Expandable Tube
- 97 Parts Station™ Storage Cabinets
- 98 Utility Workstation™ Cart & Bin Storage Systems
- 99 Rolling Tote Storage Cabinet
- 100 Pistol Pack Series, Zerust® Bags and Stop Rust Gun Plug
- 101 Economy, Single and Double Gun Cases
- 102 Tactical Series: Small, Medium and Large Tactical Cases
- 103 Linesman Case

WATERPROOF

Pages 104 - 105

- 104 Waterproof Satchels
- 105 The HD Series: Small, Medium and Large

MEDICAL

Pages 106 - 111

- 106 Paramedic Gear Box and Paramedic Case
- 107 First Aid Cases and Paramedic Box
- 108 Command Center Box and Trauma Drug Kits
- 109 Drawer Cabinets, Dimensions & Replacement Drawers
- 110 Medical Device Box and Instrument Boxes
- 111 ScriptSafe® Case

CONDUCTIVE

Pages 112 - 115

- 112 Conductive Cases
- 113 Conductive Boxes Storage Cabinets
- 114 Tool Box & Compt Boxes: 10-1/2" x 6-3/16" x 1-9/16" (26.67 x 15.72 x 3.97 cm) - 12-3/4" x 8-1/2" x 2-1/8" (32.39 x 21.59 x 5.40 cm)
- 115 600/800 Series Conductive Boxes, Conductive Storage Bins



Customer Service: (800) 344-5716
 15981 Valplast Street, Middlefield, Ohio 44062
Ph: (440) 632-1631 • Fax: (440) 632-1581



Manston Road, Ramsgate, Kent. CT12 6HW, UK
Tel: +44 (0)1843-854000 • Fax: +44 (0) 1843-854046

Check out our site: flambeaucases.com



© 2016 Flambeau® Inc. All Rights Reserved. Zerust® is a registered trademark of Northern Technologies International Corporation.
 Company names and logos within this catalog are used with permission and are registered trademarks of the respective companies
 © 2016. All Rights are Reserved by the respective companies.

X-ON Electronics

Largest Supplier of Electrical and Electronic Components

Click to view similar products for [Storage Boxes & Cases](#) category:

Click to view products by [Flambeau](#) manufacturer:

Other Similar products are found below :

[120Y](#) [120R](#) [DB613](#) [18090-2](#) [A221](#) [17800-2](#) [T221](#) [T824](#) [57/13512PK](#) [6777TF](#) [T1400](#) [3005C](#) [A101](#) [DB226](#) [DB216](#) [T4004](#) [T623](#) [T9100](#)
[T5008](#) [DB211](#) [K818](#) [A208](#) [A618](#) [6734PF](#) [T9501](#) [18192-2](#) [DB201](#) [6785TC](#) [T900BK](#) [A602](#) [A209](#) [5202CL](#) [T1408B](#) [PPK-29087](#) [SE52F,](#)
[RD](#) [38845](#) [38848](#) [38851](#) [38854](#) [K216](#) [54439](#) [54445](#) [54448](#) [54451](#) [55600](#) [1206706](#) [3069520](#) [3203008](#) [5020658](#) [5028731](#)