

BMR462 series PoL Regulators
 Input 4.5-14 V, Output up to 12 A / 60 W

1/28701-BMR 462 Rev.A November 2017

© Flex

Key Features

- Small package
 Laydown: 21.0 x 12.7 x 8.2 mm (0.827 x 0.5 x 0.323 in)
 SIP: 20.8 x 7.6 x 15.6 mm (0.82 x 0.3 x 0.612 in)
- 0.6 V - 5.0 V output voltage range
- High efficiency, typ. 97.1% at 5Vin, 3.3Vout half load
- Configuration and Monitoring via PMBus
- Synchronization & phase spreading
- Voltage Tracking & Voltage margining
- MTBF 21.2 Mh

General Characteristics

- Fully regulated
- For narrow board pitch applications (15 mm/0.6 in)
- Non-Linear Response for reduction of decoupling cap.
- Input under voltage shutdown
- Over temperature protection
- Output short-circuit & Output over voltage protection
- Remote control & Power Good
- Voltage setting via pin-strap or PMBus
- Advanced Configurable via Graphical Used Interface
- ISO 9001/14001 certified supplier
- Highly automated manufacturing ensures quality

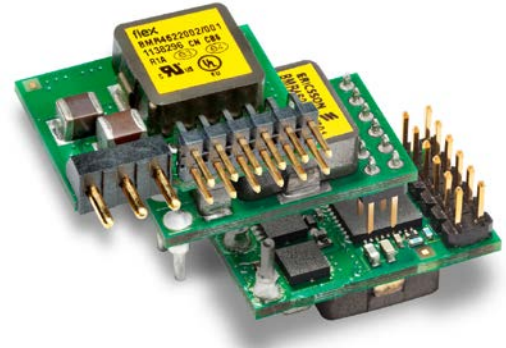

Safety Approvals



Design for Environment



Meets requirements in high-temperature lead-free soldering processes.

Contents

| | |
|--|--|
| Ordering Information | 2 |
| General Information | 2 |
| Safety Specification | 3 |
| Absolute Maximum Ratings | 4 |
| | |
| Electrical Specification | |
| 12A/ 0.6-5V Lay Down version and Power Good option | BMR4620002 (TH) BMR4621002 (SMD) BMR4620006 (TH) BMR4621006 (SMD) 5 BMR4622002..... 13 |
| 12A/ 0.6-5V Single in Line version (SIP) | |
| | |
| EMC Specification | 21 |
| Operating Information | 21 |
| Thermal Consideration | 30 |
| Connections | 31 |
| Mechanical Information | 40 |
| Soldering Information | 43 |
| Delivery Information | 44 |
| Product Qualification Specification | 46 |

BMR462 series PoL Regulators Input 4.5-14 V, Output up to 12 A / 60 W

1/28701-BMR 462 Rev.A November 2017

© Flex

Ordering Information

| Product program | Output |
|-----------------|------------------------|
| BMR 462 | 0.6-5.0 V, 12 A / 60 W |

Product number and Packaging

| BMR 462 n ₁ n ₂ n ₃ n ₄ /n ₅ n ₆ n ₇ n ₈ | | | | | | | | | |
|--|----------------|----------------|----------------|----------------|---|----------------|----------------|----------------|----------------|
| Options | n ₁ | n ₂ | n ₃ | n ₄ | / | n ₅ | n ₆ | n ₇ | n ₈ |
| Mounting | o | | | | / | | | | |
| Mechanical | | o | | | / | | | | |
| Digital interface | | | o | o | / | | | | |
| Configuration file | | | | | / | o | o | o | |
| Packaging | | | | | / | | | | o |

Options Description

| Options | Description |
|--|---|
| n ₁ | 0 Through hole mount version (TH) 1 Surface mount version (SMD) 2 Single in line (SIP) |
| n ₂ | 0 Standard mechanical option 1 5.5mm pin length (for SIP) 3 3.28mm pin length (for SIP) |
| n ₃ n ₄ | 02 PMBus and analog pin strap, with Voltage Tracking Pin 06* PMBus and analog pin strap, with Power Good Pin (for Lay Down version only) |
| n ₅ n ₆ n ₇ | 001 Standard configuration 002 Negative logic |
| n ₈ | B Antistatic tray of 100 products (SIP only) C Antistatic tape & reel of 200 products (Sample delivery available in lower quantities. Not for SIP) |

* Power Good pin option is only available in Lay Down version. (see connections' information in page 31)

Example: Product number BMR 462 0002/001C equals a through-hole mounted, open frame, PMBus and analog pin strap, voltage tracking pin at 4A, positive RC logic, standard configuration variant, package tape&reel

General Information

Reliability

The failure rate (λ) and mean time between failures (MTBF = $1/\lambda$) is calculated at max output power and an operating ambient temperature (T_A) of +40°C. Flex uses Telcordia SR-332 Issue 2 Method 1 to calculate the mean steady-state failure rate and standard deviation (σ).

Telcordia SR-332 Issue 2 also provides techniques to estimate the upper confidence levels of failure rates based on the mean and standard deviation.

| Mean steady-state failure rate, λ | Std. deviation, σ |
|---|--------------------------|
| 47 nFailures/h | 12.4 nFailures/h |

MTBF (mean value) for the BMR 462 series = 21.2 Mh.
MTBF at 90% confidence level = 15.9 Mh

Compatibility with RoHS requirements

The products are compatible with the relevant clauses and requirements of the RoHS directive 2002/95/EC and have a maximum concentration value of 0.1% by weight in homogeneous materials for lead, mercury, hexavalent chromium, PBB and PBDE and of 0.01% by weight in homogeneous materials for cadmium.

Exemptions in the RoHS directive utilized in Flex Power Modules products are found in the Statement of Compliance document.

Flex fulfills and will continuously fulfill all its obligations under regulation (EC) No 1907/2006 concerning the registration, evaluation, authorization and restriction of chemicals (REACH) as they enter into force and is through product materials declarations preparing for the obligations to communicate information on substances in the products.

Quality Statement

The products are designed and manufactured in an industrial environment where quality systems and methods like ISO 9000, Six Sigma, and SPC are intensively in use to boost the continuous improvements strategy. Infant mortality or early failures in the products are screened out and they are subjected to an ATE-based final test. Conservative design rules, design reviews and product qualifications, plus the high competence of an engaged work force, contribute to the high quality of the products.

Warranty

Warranty period and conditions are defined in Flex General Terms and Conditions of Sale.

Limitation of Liability

Flex does not make any other warranties, expressed or implied including any warranty of merchantability or fitness for a particular purpose (including, but not limited to, use in life support applications, where malfunctions of product can cause injury to a person's health or life).

© Flex 2017

The information and specifications in this technical specification is believed to be correct at the time of publication. However, no liability is accepted for inaccuracies, printing errors or for any consequences thereof. Flex reserves the right to change the contents of this technical specification at any time without prior notice.

| | |
|---|--|
| BMR462 series PoL Regulators Input 4.5-14 V, Output up to 12 A / 60 W | 1/28701-BMR 462 Rev.A November 2017 |
| | © Flex |

Safety Specification

General information

Flex DC/DC converters and DC/DC regulators are designed in accordance with safety standards IEC/EN/UL 60950-1 *Safety of Information Technology Equipment*.

IEC/EN/UL 60950-1 contains requirements to prevent injury or damage due to the following hazards:

- Electrical shock
- Energy hazards
- Fire
- Mechanical and heat hazards
- Radiation hazards
- Chemical hazards

On-board DC/DC converters and DC/DC regulators are defined as component power supplies. As components they cannot fully comply with the provisions of any safety requirements without "Conditions of Acceptability". Clearance between conductors and between conductive parts of the component power supply and conductors on the board in the final product must meet the applicable safety requirements. Certain conditions of acceptability apply for component power supplies with limited stand-off (see Mechanical Information for further information). It is the responsibility of the installer to ensure that the final product housing these components complies with the requirements of all applicable safety standards and regulations for the final product.

Component power supplies for general use should comply with the requirements in IEC 60950-1, EN 60950-1 and UL 60950-1 *Safety of Information Technology Equipment*. There are other more product related standards, e.g. IEEE 802.3 *CSMA/CD (Ethernet) Access Method*, and ETS-300132-2 *Power supply interface at the input to telecommunications equipment, operated by direct current (dc)*, but all of these standards are based on IEC/EN/UL 60950-1 with regards to safety.

Flex DC/DC converters and DC/DC regulators are UL 60950-1 recognized and certified in accordance with EN 60950-1.

The flammability rating for all construction parts of the products meet requirements for V-0 class material according to IEC 60695-11-10, *Fire hazard testing, test flames* – 50 W horizontal and vertical flame test methods.

The products should be installed in the end-use equipment, in accordance with the requirements of the ultimate application. Normally the output of the DC/DC converter is considered as SELV (Safety Extra Low Voltage) and the input source must be isolated by minimum Double or Reinforced Insulation from the primary circuit (AC mains) in accordance with IEC/EN/UL 60950-1.

Non-isolated DC/DC regulators

The input voltage to the DC/DC regulator is SELV (Safety Extra Low Voltage) and the output remains SELV under normal and abnormal operating conditions.

BMR462 series PoL Regulators
 Input 4.5-14 V, Output up to 12 A / 60 W

1/28701-BMR 462 Rev.A November 2017

© Flex

Absolute Maximum Ratings

| Characteristics | | min | typ | max | Unit |
|-----------------------------|--|------|-----|-----|------|
| T _{P1} | Operating temperature (see Thermal Consideration section) | -40 | | 120 | °C |
| T _S | Storage temperature | -40 | | 125 | °C |
| V _I | Input voltage (See Operating Information Section for input and output voltage relations) | -0.3 | | 16 | V |
| Logic I/O voltage | CTRL, SA0, SA1, SALERT, SCL, SDA, VSET, SYNC, GCB, PG | -0.3 | | 6.5 | V |
| Ground voltage differential | -S, PREF, GND | -0.3 | | 0.3 | V |
| Analog pin voltage | V _O , +S, VTRK | -0.3 | | 6.5 | V |

Stresses above those listed under Absolute Maximum Ratings may cause permanent damage to the device. This is a stress rating only; functional operation of the device at these or any other conditions above those indicated in the Electrical Specification section of this specification is not implied. Exposure to absolute maximum rating conditions for extended periods may affect device reliability. See technical paper TP023 for details on how data retention time of the Non-Volatile Memory (NVM) of the product is affected by high temperature.

Configuration File

This product is designed with a digital control circuit. The control circuit uses a configuration file which determines the functionality and performance of the product. The Electrical Specification table shows parameter values of functionality and performance with the Standard configuration, unless otherwise specified. The Standard configuration is designed to fit most application needs. Changes in Standard configuration might be required to optimize performance in specific application.

Fundamental Circuit Diagram

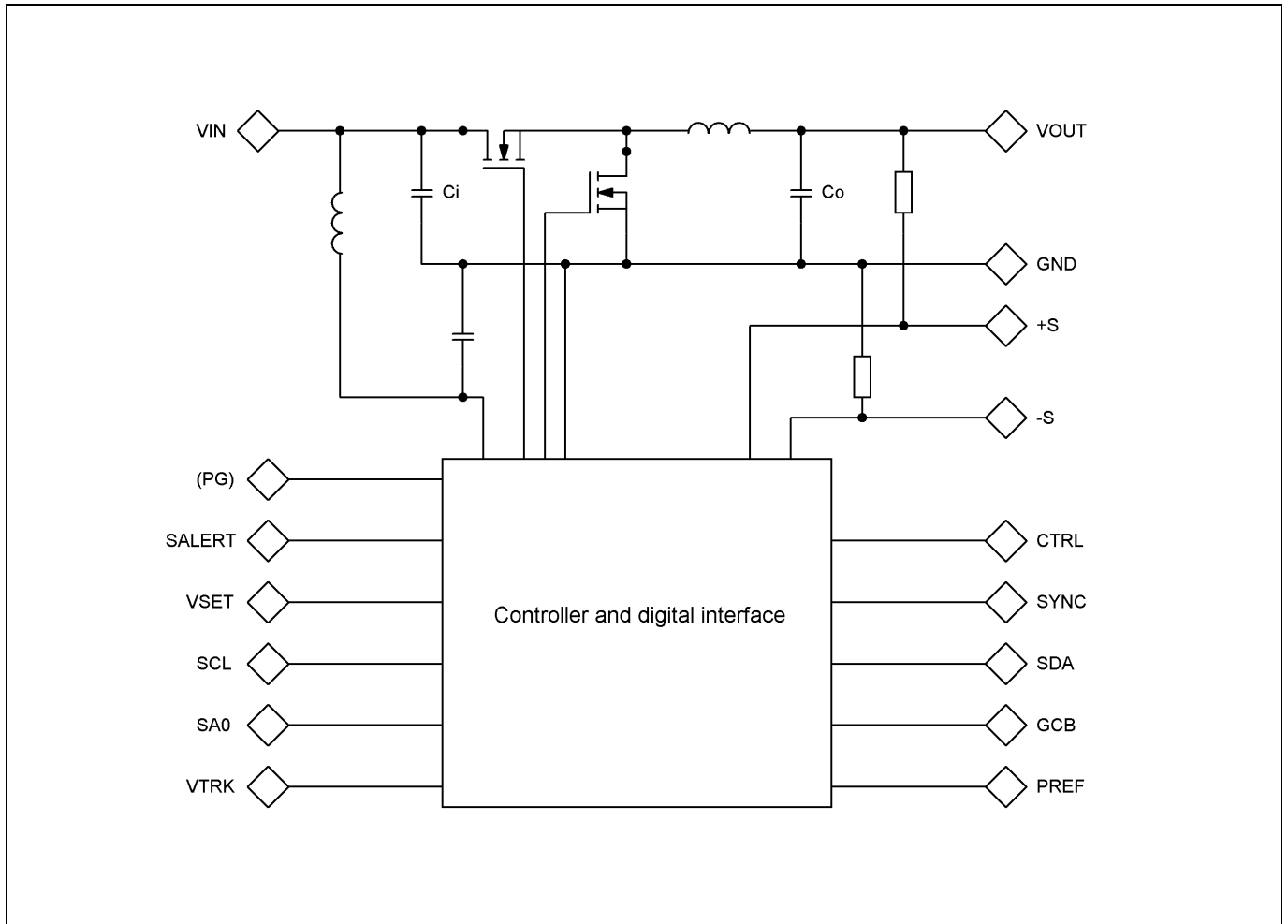

C_i=22 μF C_o =100 μF

BMR462 series PoL Regulators
 Input 4.5-14 V, Output up to 12 A / 60 W

1/28701-BMR 462 Rev.A November 2017

© Flex

Electrical Specification

BMR 462 0002, BMR 462 1002, BMR 462 0006, BMR 462 1006

$T_{P1} = -30$ to $+95^{\circ}\text{C}$, $V_I = 4.5$ to 14 V , $V_I > V_O + 1.0\text{ V}$

Typical values given at: $T_{P1} = +25^{\circ}\text{C}$, $V_I = 12.0\text{ V}$, max I_O , unless otherwise specified under Conditions.

Default configuration file, 190 10-CDA 102 0207/001.

External $C_{IN} = 470\ \mu\text{F}/10\ \text{m}\Omega$, $C_{OUT} = 470\ \mu\text{F}/10\ \text{m}\Omega$. See Operating Information section for selection of capacitor types.

Sense pins are connected to the output pins.

| Characteristics | | Conditions | min | typ | max | Unit |
|-----------------|-------------------------|------------|-----|-----|-----|------|
| V_I | Input voltage rise time | monotonic | | | 2.4 | V/ms |

| | | | | | | | |
|------------------------------------|---|----------------------|--|-------------|-----|---------|----------|
| V_O | Output voltage without pin strap | | | 1.2 | | V | |
| | Output voltage adjustment range | | 0.60 | | 5.0 | V | |
| | Output voltage adjustment including margining | | 0.54 | | 5.5 | V | |
| | Output voltage set-point resolution | | | ± 0.025 | | % V_O | |
| | Output voltage accuracy | | Including line, load, temp. See Note 15 | -1 | | 1 | % |
| | Internal resistance +S/-S to VOUT/GND | | | | 4.7 | | Ω |
| | Line regulation | | $V_O = 0.6\text{ V}$ | | 2 | | mV |
| | | | $V_O = 1.0\text{ V}$ | | 2 | | |
| | | | $V_O = 3.3\text{ V}$ | | 2 | | |
| | | | $V_O = 5.0\text{ V}$ | | 3 | | |
| Load regulation; $I_O = 0 - 100\%$ | | $V_O = 0.6\text{ V}$ | | 3 | | mV | |
| | | $V_O = 1.0\text{ V}$ | | 2 | | | |
| | | $V_O = 3.3\text{ V}$ | | 2 | | | |
| | | $V_O = 5.0\text{ V}$ | | 2 | | | |
| V_{Oac} | Output ripple & noise $C_O=470\ \mu\text{F}$ (minimum external capacitance). See Note 12 | | $V_O = 0.6\text{ V}$ | | 20 | mVp-p | |
| | | | $V_O = 1.0\text{ V}$ | | 30 | | |
| | | | $V_O = 3.3\text{ V}$ | | 60 | | |
| | | | $V_O = 5.0\text{ V}$ | | 100 | | |

| | | | | | | | |
|-----------|-----------------------------------|---------------------------------|----------------------|-------|------|----|---|
| I_O | Output current | | See Note 17 | 0.001 | | 12 | A |
| I_S | Static input current at max I_O | | $V_O = 0.6\text{ V}$ | | 0.76 | | A |
| | | | $V_O = 1.0\text{ V}$ | | 1.17 | | |
| | | | $V_O = 3.3\text{ V}$ | | 3.53 | | |
| | | | $V_O = 5.0\text{ V}$ | | 4.1 | | |
| I_{lim} | Current limit threshold | | | 14 | | 20 | A |
| I_{sc} | Short circuit current | RMS, hiccup mode, See Note 3 | $V_O = 0.6\text{ V}$ | | 8 | | A |
| | | | $V_O = 1.0\text{ V}$ | | 6 | | |
| | | | $V_O = 3.3\text{ V}$ | | 5 | | |
| | | | $V_O = 5.0\text{ V}$ | | 4 | | |

| | | | | | | | |
|----------|--------------------------------|--|----------------------|----------------------|------|------|---|
| η | Efficiency | 50% of max I_O | $V_O = 0.6\text{ V}$ | | 82.6 | % | |
| | | | $V_O = 1.0\text{ V}$ | | 88.5 | | |
| | | | $V_O = 3.3\text{ V}$ | | 94.7 | | |
| | | | $V_O = 5.0\text{ V}$ | | 95.7 | | |
| | | | max I_O | $V_O = 0.6\text{ V}$ | | 78.5 | % |
| | | | | $V_O = 1.0\text{ V}$ | | 85.4 | |
| | | | | $V_O = 3.3\text{ V}$ | | 93.6 | |
| | | | | $V_O = 5.0\text{ V}$ | | 94.9 | |
| P_d | Power dissipation at max I_O | | $V_O = 0.6\text{ V}$ | | 2.05 | W | |
| | | | $V_O = 1.0\text{ V}$ | | 2.11 | | |
| | | | $V_O = 3.3\text{ V}$ | | 2.66 | | |
| | | | $V_O = 5.0\text{ V}$ | | 3.15 | | |
| P_{ii} | Input idling power (no load) | Default configuration: Continues Conduction Mode, CCM | $V_O = 0.6\text{ V}$ | | 0.33 | W | |
| | | | $V_O = 1.0\text{ V}$ | | 0.35 | | |
| | | | $V_O = 3.3\text{ V}$ | | 0.56 | | |
| | | | $V_O = 5.0\text{ V}$ | | 0.99 | | |

BMR462 series PoL Regulators
 Input 4.5-14 V, Output up to 12 A / 60 W

1/28701-BMR 462 Rev.A November 2017

© Flex

| Characteristics | | | Conditions | min | typ | max | Unit |
|-----------------|--|--------------------------|---|-----|-----|-------|------------|
| P_{CTRL} | Input standby power | Turned off with CTRL-pin | Default configuration: Monitoring enabled, Precise timing enabled | | 180 | | mW |
| C_i | Internal input capacitance | | | | 22 | | μF |
| C_o | Internal output capacitance | | | | 100 | | μF |
| C_{OUT} | Total external output capacitance | | See Note 10 | 300 | | 7 500 | μF |
| | ESR range of capacitors (per single capacitor) | | See Note 10 | 5 | | 30 | m Ω |

| | | | | | | | |
|-----------|---|--|---------------|--|-----|--|---------|
| V_{tr1} | Load transient peak voltage deviation Load step 25-75-25% of max I_o | Default configuration $di/dt = 2 A/\mu s$ $C_o=470 \mu F$ (minimum external capacitance) see Note 13 | $V_o = 0.6 V$ | | 55 | | mV |
| | | | $V_o = 1.0 V$ | | 65 | | |
| | | | $V_o = 3.3 V$ | | 110 | | |
| | | | $V_o = 5.0 V$ | | 190 | | |
| t_{tr1} | Load transient recovery time, Note 5 Load step 25-75-25% of max I_o | Default configuration $di/dt = 2 A/\mu s$ $C_o=470 \mu F$ (minimum external capacitance) see Note 13 | $V_o = 0.6 V$ | | 230 | | μs |
| | | | $V_o = 1.0 V$ | | 210 | | |
| | | | $V_o = 3.3 V$ | | 200 | | |
| | | | $V_o = 5.0 V$ | | 200 | | |

| | | | | | | | |
|-------|--|-----------------------|--|---------|--|----|-----|
| f_s | Switching frequency | | | 320 | | | kHz |
| | Switching frequency range | PMBus configurable | | 200-640 | | | kHz |
| | Switching frequency set-point accuracy | | | ± 5 | | | % |
| | Control Circuit PWM Duty Cycle | | | 5 | | 95 | % |
| | Minimum Sync Pulse Width | | | 150 | | | ns |
| | Synchronization Frequency Tolerance | External clock source | | -13 | | 13 | % |

| | | | | | | | |
|---|-----------------------------|--------------------|--|--------------------------|---------|-----|---------|
| Input Under Voltage Lockout, UVLO | UVLO threshold | | | 3.85 | | | V |
| | UVLO threshold range | PMBus configurable | | 3.85-14 | | | V |
| | Set point accuracy | | | -150 | | 150 | mV |
| | UVLO hysteresis | | | | 0.35 | | V |
| | UVLO hysteresis range | PMBus configurable | | | 0-10.15 | | V |
| | Delay | | | | | 2.5 | μs |
| Input Over Voltage Protection, IOVP | Fault response | See Note 3 | | Automatic restart, 70 ms | | | |
| | IOVP threshold | | | 16 | | | V |
| | IOVP threshold range | PMBus configurable | | 4.2-16 | | | V |
| | Set point accuracy | | | -150 | | 150 | mV |
| | IOVP hysteresis | | | | 1 | | V |
| | IOVP hysteresis range | PMBus configurable | | | 0-11.8 | | V |
| Power Good, PG, See Note 2 | Delay | | | | | 2.5 | μs |
| | Fault response | See Note 3 | | Automatic restart, 70 ms | | | |
| | PG threshold | | | 90 | | | % V_o |
| | PG hysteresis | | | 5 | | | % V_o |
| | PG delay | | | 10 | | | ms |
| | PG delay range | PMBus configurable | | 0-500 | | | s |
| Output voltage Over/Under Voltage Protection, OVP/UVP | UVP threshold | | | 85 | | | % V_o |
| | UVP threshold range | PMBus configurable | | 0-100 | | | % V_o |
| | UVP hysteresis | | | 5 | | | % V_o |
| | OVP threshold | | | 115 | | | % V_o |
| | OVP threshold range | PMBus configurable | | 100-115 | | | % V_o |
| | UVP/OVP response time | | | 25 | | | μs |
| | UVP/OVP response time range | PMBus configurable | | 5-60 | | | μs |
| Fault response | See Note 3 | | | Automatic restart, 70 ms | | | |

BMR462 series PoL Regulators
 Input 4.5-14 V, Output up to 12 A / 60 W

1/28701-BMR 462 Rev.A November 2017

© Flex

| Characteristics | | Conditions | min | typ | max | Unit |
|---|------------------------|--------------------|-----|---------------------------|-----|-----------------|
| Over Current Protection, OCP | OCP threshold | | | 18 | | A |
| | OCP threshold range | PMBus configurable | | 0-18 | | A |
| | Protection delay, | See Note 4 | | 5 | | T _{sw} |
| | Protection delay range | PMBus configurable | | 1-32 | | T _{sw} |
| | Fault response | See Note 3 | | Automatic restart, 70 ms | | |
| Over Temperature Protection, OTP at P1 See Note 9 | OTP threshold | | | 120 | | °C |
| | OTP threshold range | PMBus configurable | | -40...+120 | | °C |
| | OTP hysteresis | | | 15 | | °C |
| | OTP hysteresis range | PMBus configurable | | 0-160 | | °C |
| | Fault response | See Note 3 | | Automatic restart, 240 ms | | |

| | | | | | | |
|-------------------|-------------------------------------|---|------|--|-----|-----|
| V _{IL} | Logic input low threshold | SYNC, SA0, SA1, SCL, SDA, GCB, CTRL, VSET | | | 0.8 | V |
| V _{IH} | Logic input high threshold | | 2 | | | V |
| I _{IL} | Logic input low sink current | CTRL | | | 0.6 | mA |
| V _{OL} | Logic output low | | | | 0.4 | V |
| V _{OH} | Logic output high | SYNC, SCL, SDA, SALERT, GCB, PG | 2.25 | | | V |
| I _{OL} | Logic output low sink current | | | | 4 | mA |
| I _{OH} | Logic output high source current | | | | 2 | mA |
| t _{set} | Setup time, SMBus | See Note 1 | 300 | | | ns |
| t _{hold} | Hold time, SMBus | See Note 1 | 250 | | | ns |
| t _{free} | Bus free time, SMBus | See Note 1 | 2 | | | ms |
| f _{SMB} | Supported SMBus Operating frequency | | 10 | | 100 | kHz |
| C _p | Internal capacitance on logic pins | | | | 10 | pF |

| | | | | | | | |
|--------------------------------------|-------------------------|---|--|----------|----------|----|----|
| Boot-up time | | See Note 11 | | 35 | | ms | |
| Output Voltage Delay Time See Note 6 | Delay duration | | | 10 | | ms | |
| | Delay duration range | PMBus configurable | | 2-500000 | | | |
| | Delay accuracy turn-on | Default configuration: CTRL controlled Precise timing enabled | | | ±0.25 | | ms |
| | | PMBus controlled Precise timing disabled | | | -0.25/+4 | | ms |
| | Delay accuracy turn-off | | | | -0.25/+4 | | ms |
| Output Voltage Ramp Time See Note 14 | Ramp duration | | | 10 | | ms | |
| | Ramp duration range | PMBus configurable | | 0-200 | | | |
| | Ramp time accuracy | | | | 100 | | µs |

| | | | | | | |
|---|---------------------------|--|------|-----|-----|----|
| VTRK Input Bias Current | V _{VTRK} = 5.5 V | | | 110 | 200 | µA |
| VTRK Tracking Ramp Accuracy (V _O - V _{VTRK}) | 100% Tracking, see Note 8 | | -100 | | 100 | mV |
| VTRK Regulation Accuracy (V _O - V _{VTRK}) | 100% Tracking | | -1 | | 1 | % |

| | | | | | | | |
|---------------------|-----------------------------|--|--|---|------|---|---|
| Monitoring accuracy | READ_VIN vs V _I | | | 3 | | % | |
| | READ_VOUT vs V _O | | | 1 | | % | |
| | READ_IOUT vs I _O | I _O = 0-12 A, T _{P1} = 0 to +95°C V _I = 12 V | | | ±1.6 | | A |
| | READ_IOUT vs I _O | I _O = 0-12 A, T _{P1} = 0 to +95°C V _I = 4.5-14 V | | | ±2.7 | | A |

Note 1: See section I2C/SMBus Setup and Hold Times – Definitions.

Note 2: Monitorable over PMBus Interface.

Note 3: Automatic restart ~70 or 240 ms after fault if the fault is no longer present. Continuous restart attempts if the fault reappear after restart. See Operating Information for other fault response options.

Note 4: T_{sw} is the switching period.

Note 5: Within +/-3% of V_O

Note 6: See section Soft-start Power Up.

Note 8: Tracking functionality is designed to follow a VTRK signal with slewrate < 2.4V/ms. For faster VTRK signals accuracy will depend on the regulator bandwidth.

Note 9: See section Over Temperature Protection (OTP).

Note 10: See section External Capacitors.

Note 11: See section Start-Up Procedure.

Note 12: See graph Output Ripple vs External Capacitance and Operating information section Output Ripple and Noise.

Note 13: See graph Load Transient vs. External Capacitance and Operating information section External Capacitors.

Note 14: Time for reaching 100% of nominal Vout.

Note 15: For Vout < 1.0V accuracy is +/-10 mV. For further deviations see section Output Voltage Adjust using PMBus.

Note 17: Without minimum load the monitoring function will cause an output voltage of ~0.6 V when the output is disabled. This does not apply if Low Power mode is used.

BMR462 series PoL Regulators
 Input 4.5-14 V, Output up to 12 A / 60 W

1/28701-BMR 462 Rev.A November 2017

© Flex

Typical Characteristics
Efficiency and Power Dissipation

BMR 462 0002, BMR 462 1002
BMR 462 0006, BMR 462 1006

Efficiency vs. Output Current, $V_I=5\text{ V}$

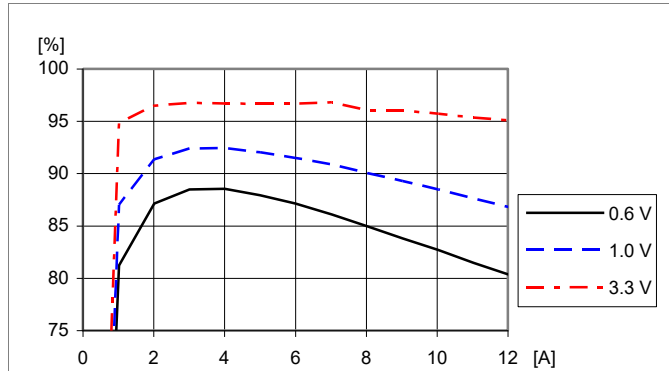

Efficiency vs. load current and output voltage:
 $T_{P1} = +25^\circ\text{C}$, $V_I=5\text{ V}$, $f_{sw}=320\text{ kHz}$, $C_O=470\text{ }\mu\text{F}/10\text{ m}\Omega$.

Power Dissipation vs. Output Current, $V_I=5\text{ V}$

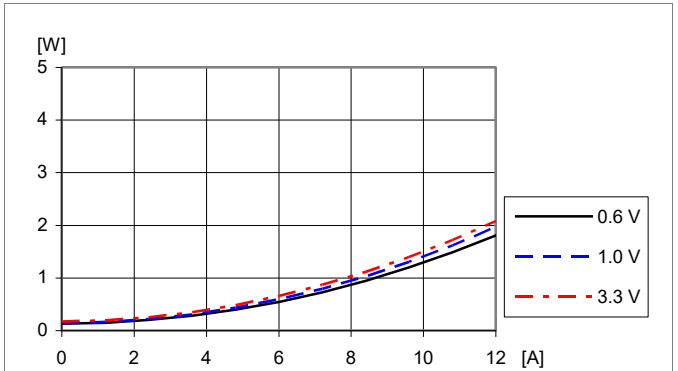

Dissipated power vs. load current and output voltage:
 $T_{P1} = +25^\circ\text{C}$, $V_I=5\text{ V}$, $f_{sw}=320\text{ kHz}$, $C_O=470\text{ }\mu\text{F}/10\text{ m}\Omega$.

Efficiency vs. Output Current, $V_I=12\text{ V}$

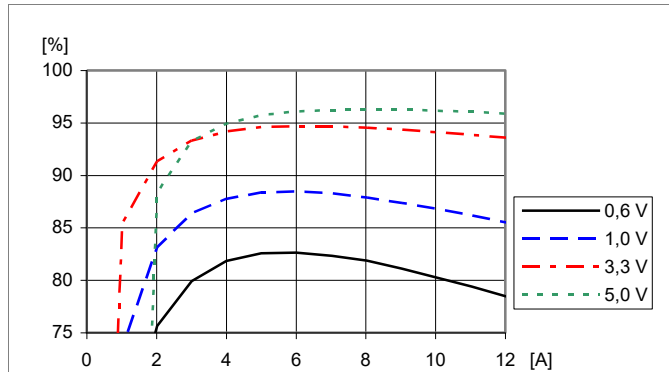

Efficiency vs. load current and output voltage at
 $T_{P1} = +25^\circ\text{C}$, $V_I=12\text{ V}$, $f_{sw}=320\text{ kHz}$, $C_O=470\text{ }\mu\text{F}/10\text{ m}\Omega$.

Power Dissipation vs. Output Current, $V_I=12\text{ V}$

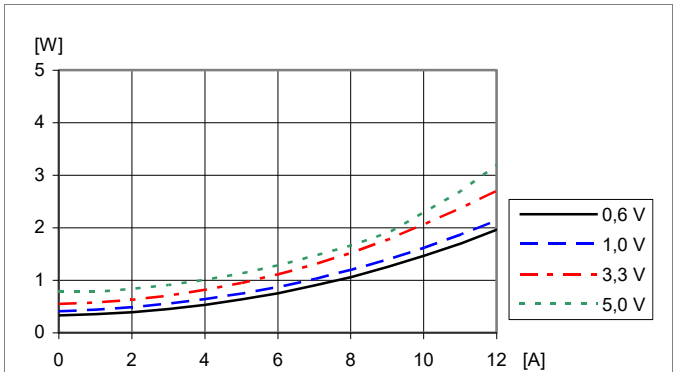

Dissipated power vs. load current and output voltage:
 $T_{P1} = +25^\circ\text{C}$, $V_I=12\text{ V}$, $f_{sw}=320\text{ kHz}$, $C_O=470\text{ }\mu\text{F}/10\text{ m}\Omega$.

Efficiency vs. Output Current and Switch Frequency

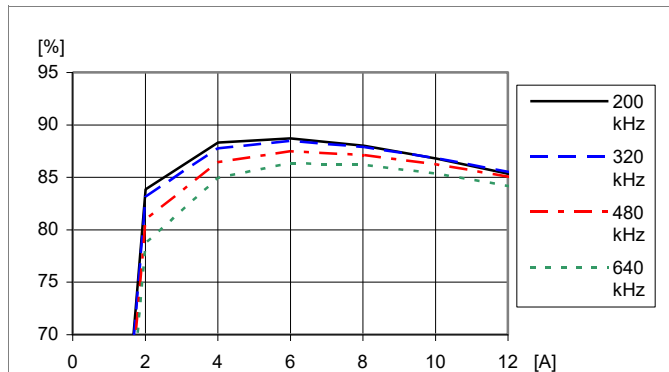

Efficiency vs. load current and switch frequency at
 $T_{P1} = +25^\circ\text{C}$, $V_I=12\text{ V}$, $V_O=1.0\text{ V}$, $C_O=470\text{ }\mu\text{F}/10\text{ m}\Omega$
 Default configuration except changed frequency.

Power Dissipation vs. Output Current and Switch Frequency

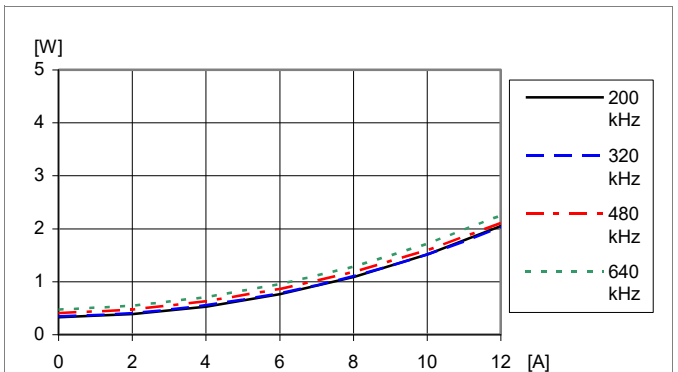

Dissipated power vs. load current and switch frequency at
 $T_{P1} = +25^\circ\text{C}$, $V_I=12\text{ V}$, $V_O=1.0\text{ V}$, $C_O=470\text{ }\mu\text{F}/10\text{ m}\Omega$
 Default configuration except changed frequency.

BMR462 series PoL Regulators
 Input 4.5-14 V, Output up to 12 A / 60 W

1/28701-BMR 462 Rev.A November 2017

© Flex

Typical Characteristics
Load Transient

BMR 462 0002, BMR 462 1002
BMR 462 0006, BMR 462 1006

Load Transient vs. External Capacitance, $V_O=1.0\text{ V}$

Load Transient vs. External Capacitance, $V_O=3.3\text{ V}$

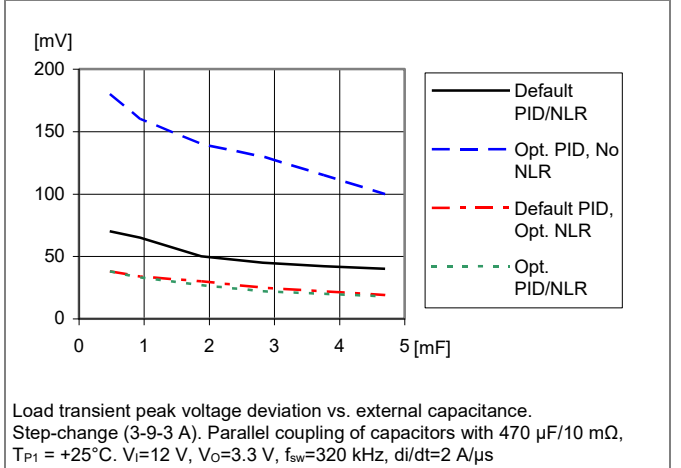
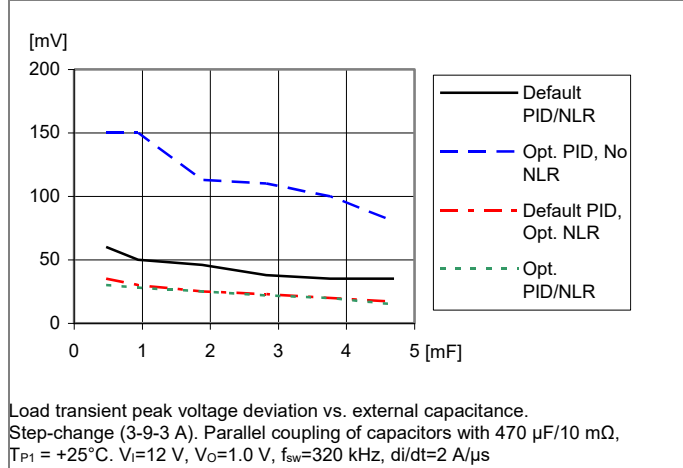

Load transient vs. Switch Frequency

Output Load Transient Response, Default PID/NLR

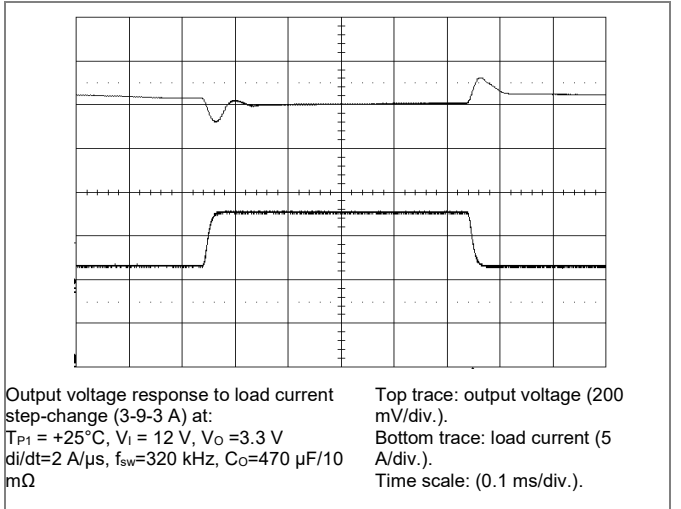
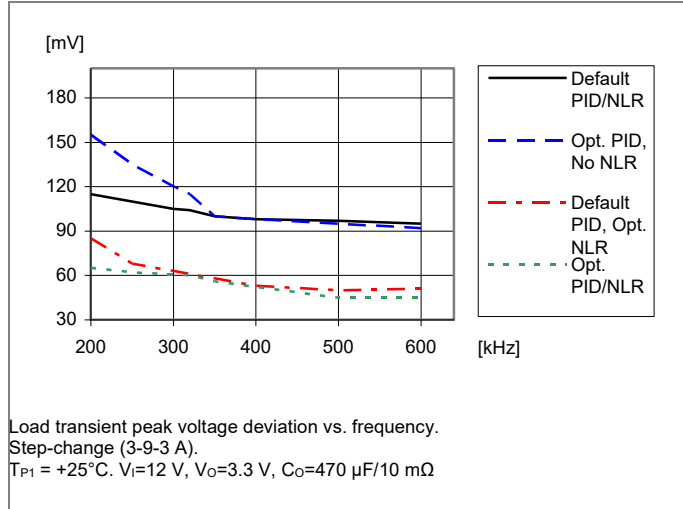

BMR462 series PoL Regulators
 Input 4.5-14 V, Output up to 12 A / 60 W

1/28701-BMR 462 Rev.A November 2017

© Flex

BMR 462 0002, BMR 462 1002
BMR 462 0006, BMR 462 1006

Typical Characteristics
Output Current Characteristic

Output Current Derating, $V_O=0.6\text{ V}$

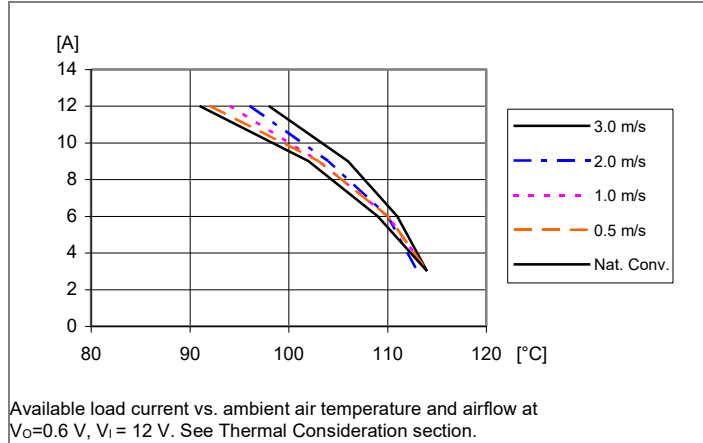

Output Current Derating, $V_O=1.0\text{ V}$

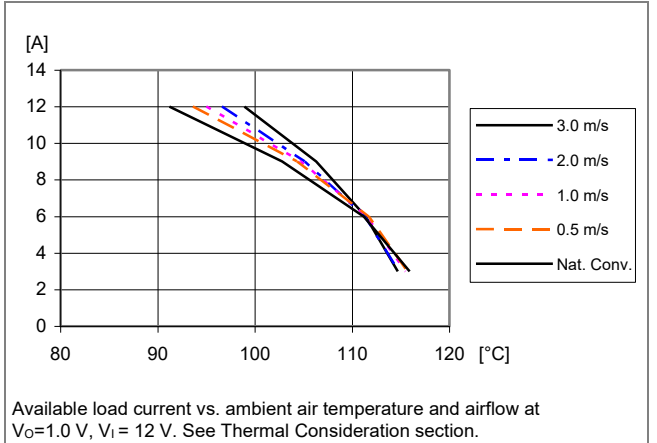

Output Current Derating, $V_O=3.3\text{ V}$

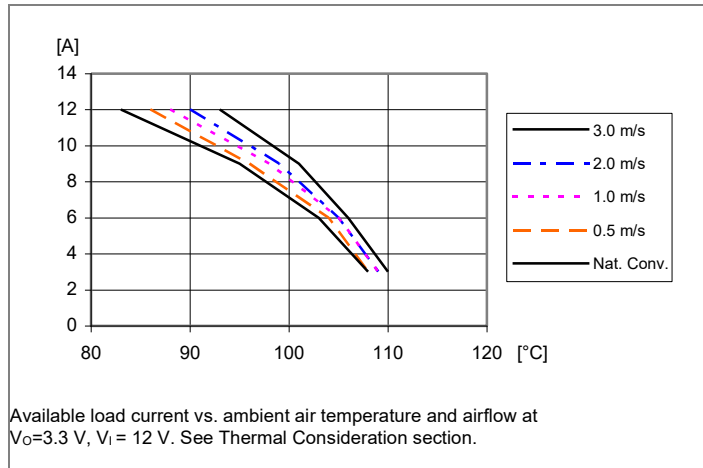

Output Current Derating, $V_O=5.0\text{ V}$

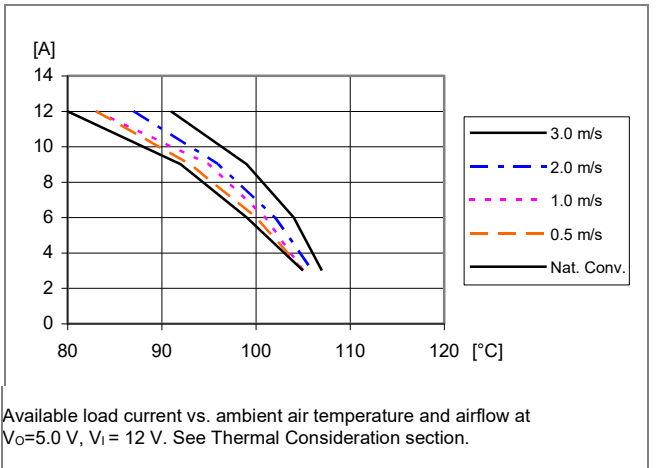

Current Limit Characteristics, $V_O=1.0\text{ V}$

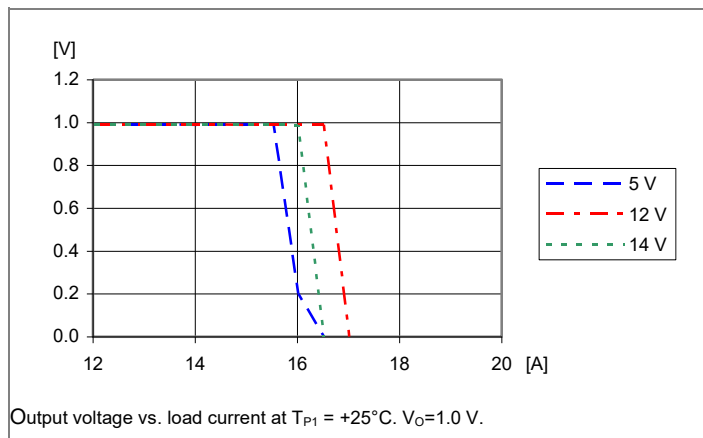

Current Limit Characteristics, $V_O=3.3\text{ V}$

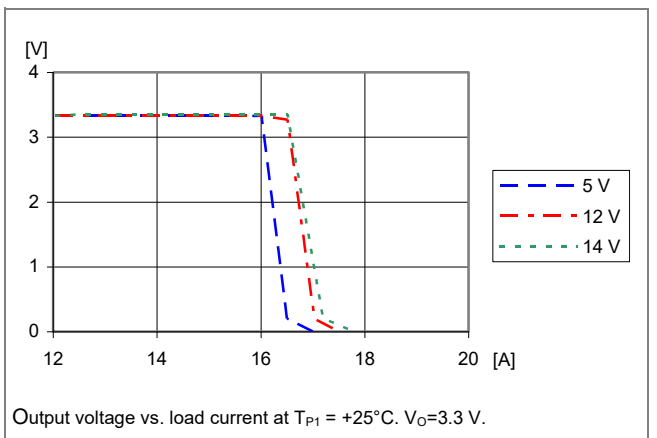

BMR462 series PoL Regulators
 Input 4.5-14 V, Output up to 12 A / 60 W

1/28701-BMR 462 Rev.A November 2017
 © Flex

Typical Characteristics
Output Voltage

BMR 462 0002, BMR 462 1002
BMR 462 0006, BMR 462 1006

Output Ripple & Noise, $V_o=1.0\text{ V}$

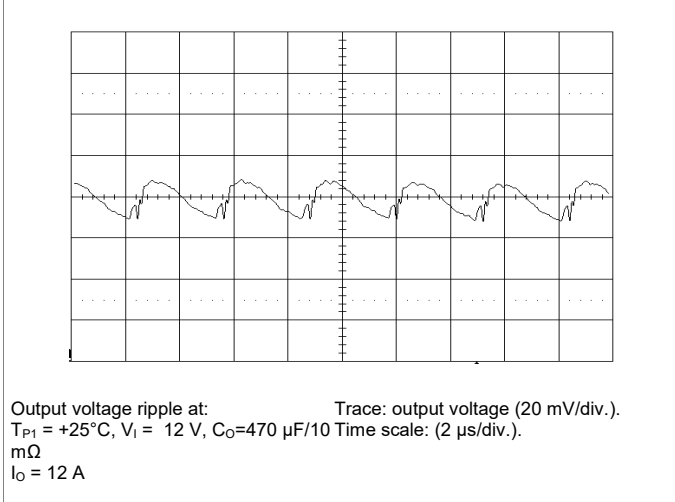

Output Ripple & Noise, $V_o=3.3\text{ V}$

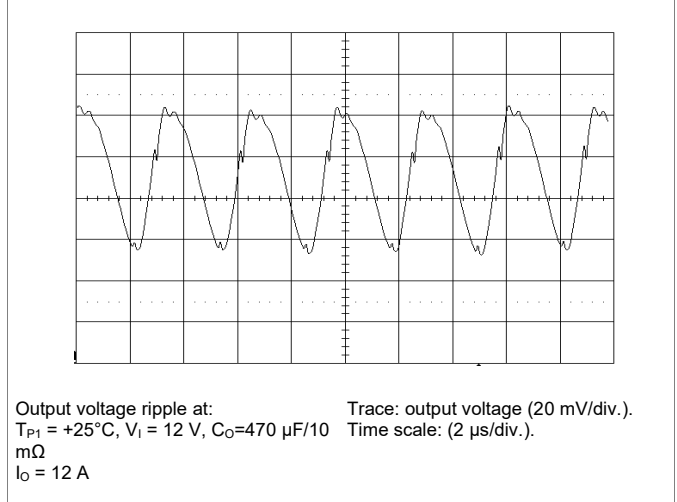

Output Ripple vs. Input Voltage

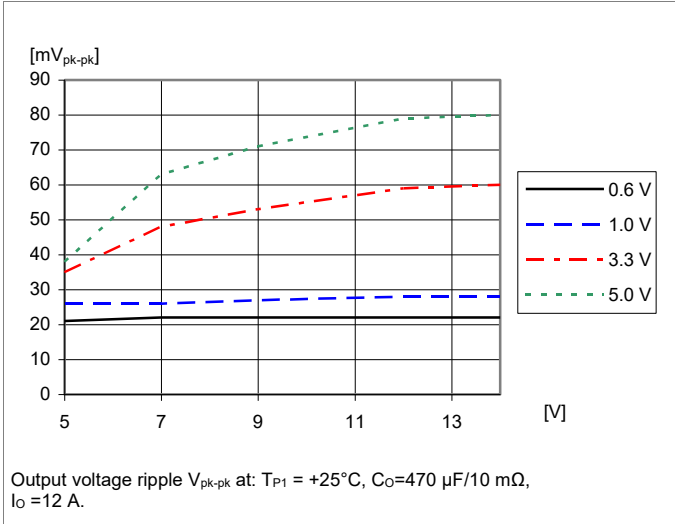

Output Ripple vs. Frequency

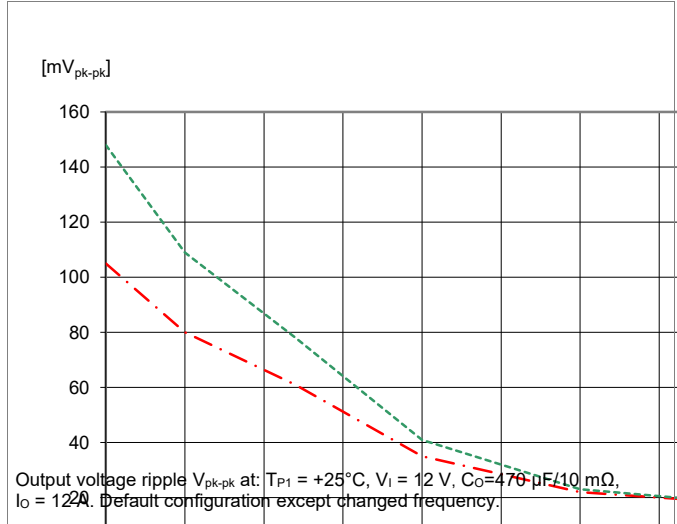

Output Ripple vs. External Capacitance

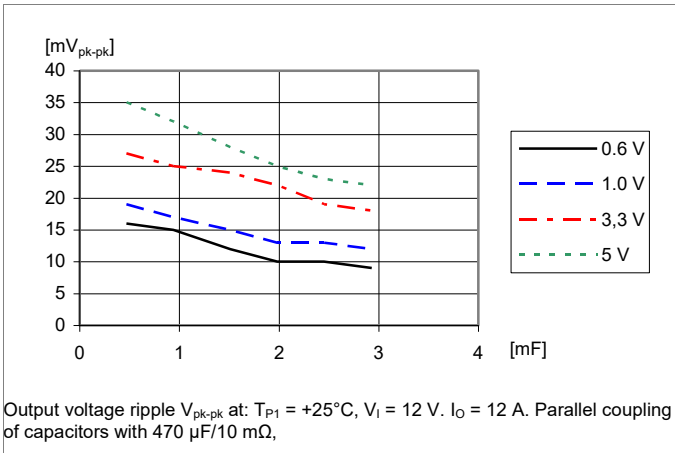

Load regulation, $V_o=3.3\text{ V}$

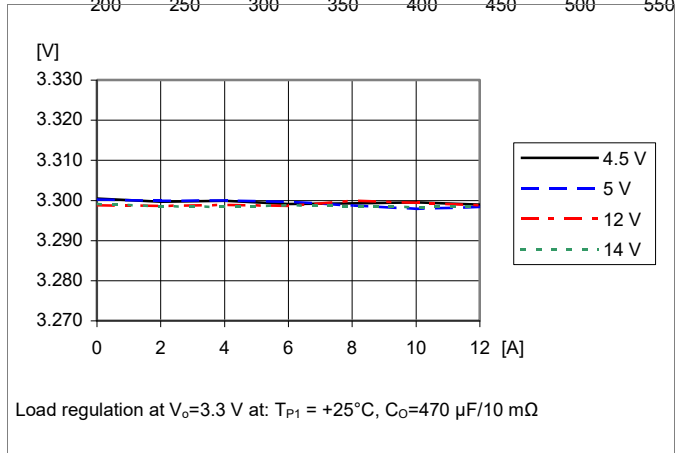

BMR462 series PoL Regulators
 Input 4.5-14 V, Output up to 12 A / 60 W

1/28701-BMR 462 Rev.A November 2017

© Flex

Typical Characteristics
Start-up and shut-down

BMR 462 0002, BMR 462 1002
BMR 462 0006, BMR 462 1006

Start-up by input source

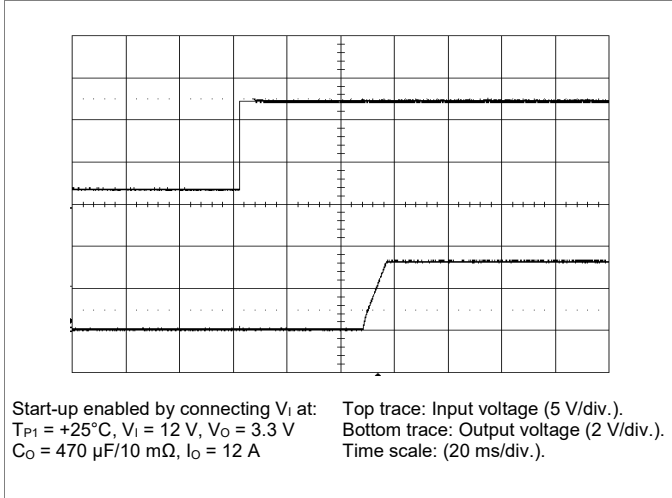

Shut-down by input source

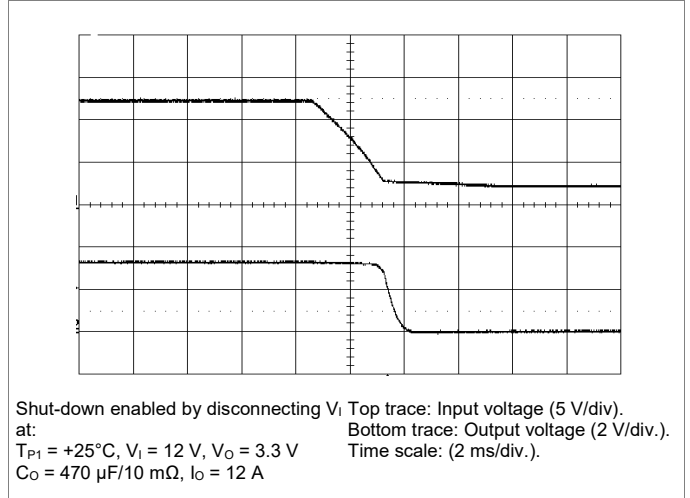

Start-up by CTRL signal

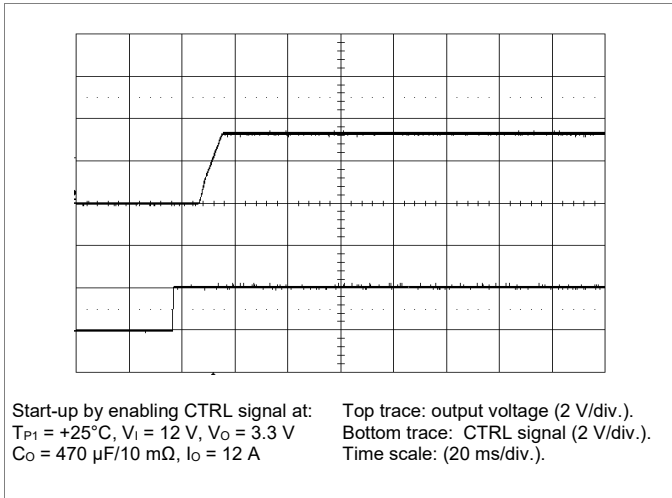

Shut-down by CTRL signal

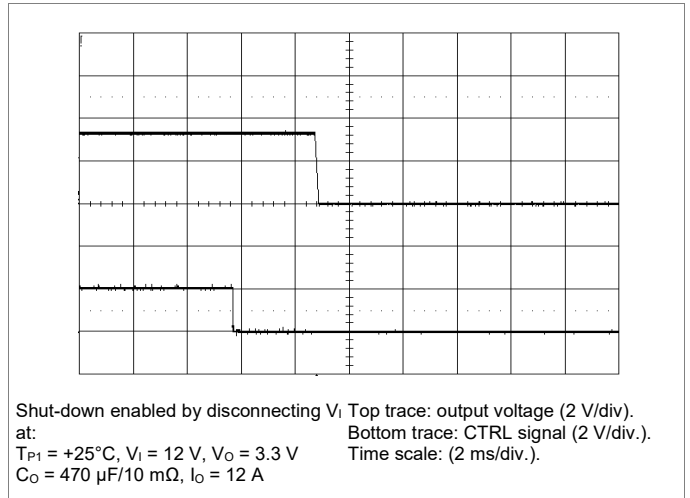

BMR462 series PoL Regulators
 Input 4.5-14 V, Output up to 12 A / 60 W

1/28701-BMR 462 Rev.A November 2017

© Flex

Electrical Specification

BMR 462 2002 (SIP)

$T_{P1} = -30$ to $+95^{\circ}\text{C}$, $V_I = 4.5$ to 14 V, $V_I > V_O + 1.0$ V

Typical values given at: $T_{P1} = +25^{\circ}\text{C}$, $V_I = 12.0$ V, max I_O , unless otherwise specified under Conditions.

Default configuration file, 190 10-CDA 102 0260/001.

External $C_{IN} = 470$ $\mu\text{F}/10$ m Ω , $C_{OUT} = 470$ $\mu\text{F}/10$ m Ω . See Operating Information section for selection of capacitor types.

Sense pins are connected to the output pins.

| Characteristics | | Conditions | min | typ | max | Unit |
|-----------------|-------------------------|------------|-----|-----|-----|------|
| V_I | Input voltage rise time | monotonic | | | 2.4 | V/ms |

| | | | | | | | |
|------------------------------------|--|---------------|--|-------------|-----|----------|---|
| V_O | Output voltage without pin strap | | | 1.2 | | V | |
| | Output voltage adjustment range | | 0.60 | | 5.0 | V | |
| | Output voltage adjustment including margining | | 0.54 | | 5.5 | V | |
| | Output voltage set-point resolution | | | ± 0.025 | | % V_O | |
| | Output voltage accuracy | | Including line, load, temp. See Note 15 | -1 | | 1 | % |
| | Internal resistance +S/-S to VOUT/GND | | | | 4.7 | Ω | |
| | Line regulation | | $V_O = 0.6$ V | | 2 | mV | |
| | | | $V_O = 1.0$ V | | 2 | | |
| | | | $V_O = 3.3$ V | | 2 | | |
| | | | $V_O = 5.0$ V | | 3 | | |
| Load regulation; $I_O = 0 - 100\%$ | | $V_O = 0.6$ V | | 3 | mV | | |
| | | $V_O = 1.0$ V | | 2 | | | |
| | | $V_O = 3.3$ V | | 2 | | | |
| | | $V_O = 5.0$ V | | 2 | | | |
| V_{Oac} | Output ripple & noise $C_O = 470$ μF (minimum external capacitance). See Note 12 | | $V_O = 0.6$ V | | 20 | mVp-p | |
| | | | $V_O = 1.0$ V | | 30 | | |
| | | | $V_O = 3.3$ V | | 55 | | |
| | | | $V_O = 5.0$ V | | 95 | | |

| | | | | | | |
|-----------|-----------------------------------|---------------------------------|---------------|-------|------|---|
| I_O | Output current | | Note 17 | 0.001 | 12 | A |
| I_S | Static input current at max I_O | | $V_O = 0.6$ V | | 0.75 | A |
| | | | $V_O = 1.0$ V | | 1.21 | |
| | | | $V_O = 3.3$ V | | 3.55 | |
| | | | $V_O = 5.0$ V | | 4.1 | |
| I_{lim} | Current limit threshold | | | 14 | 20 | A |
| I_{sc} | Short circuit current | RMS, hiccup mode, See Note 3 | $V_O = 0.6$ V | | 8 | A |
| | | | $V_O = 1.0$ V | | 6 | |
| | | | $V_O = 3.3$ V | | 5 | |
| | | | $V_O = 5.0$ V | | 4 | |

| | | | | | | | |
|----------|--------------------------------|--|---------------|---------------|------|------|---|
| η | Efficiency | 50% of max I_O | $V_O = 0.6$ V | | 82.6 | % | |
| | | | $V_O = 1.0$ V | | 88.5 | | |
| | | | $V_O = 3.3$ V | | 94.8 | | |
| | | | $V_O = 5.0$ V | | 95.7 | | |
| | | | max I_O | $V_O = 0.6$ V | | 78.1 | % |
| | | | | $V_O = 1.0$ V | | 85.2 | |
| | | | | $V_O = 3.3$ V | | 93.7 | |
| | | | | $V_O = 5.0$ V | | 94.9 | |
| P_d | Power dissipation at max I_O | | $V_O = 0.6$ V | | 1.90 | W | |
| | | | $V_O = 1.0$ V | | 1.97 | | |
| | | | $V_O = 3.3$ V | | 2.65 | | |
| | | | $V_O = 5.0$ V | | 3.12 | | |
| P_{ii} | Input idling power (no load) | Default configuration: Continues Conduction Mode, CCM | $V_O = 0.6$ V | | 0.36 | W | |
| | | | $V_O = 1.0$ V | | 0.35 | | |
| | | | $V_O = 3.3$ V | | 0.54 | | |
| | | | $V_O = 5.0$ V | | 0.97 | | |

BMR462 series PoL Regulators
 Input 4.5-14 V, Output up to 12 A / 60 W

1/28701-BMR 462 Rev.A November 2017

© Flex

| Characteristics | | | Conditions | min | typ | max | Unit |
|-----------------|--|--------------------------|---|-----|-----|-------|------------|
| P_{CTRL} | Input standby power | Turned off with CTRL-pin | Default configuration: Monitoring enabled, Precise timing enabled | | 180 | | mW |
| C_i | Internal input capacitance | | | | 22 | | μF |
| C_o | Internal output capacitance | | | | 100 | | μF |
| C_{OUT} | Total external output capacitance | | See Note 10 | 300 | | 7 500 | μF |
| | ESR range of capacitors (per single capacitor) | | See Note 10 | 5 | | 30 | m Ω |

| | | | | | |
|-----------|---------------------------------------|--|---------------|-----|---------|
| V_{tr1} | Load transient peak voltage deviation | Default configuration di/dt = 2 A/ μs $C_o=470 \mu F$ (minimum external capacitance) see Note 13 | $V_o = 0.6 V$ | 50 | mV |
| | | | $V_o = 1.0 V$ | 60 | |
| | | | $V_o = 3.3 V$ | 105 | |
| | | | $V_o = 5.0 V$ | 190 | |
| t_{tr1} | Load transient recovery time, Note 5 | Default configuration di/dt = 2 A/ μs $C_o=470 \mu F$ (minimum external capacitance) see Note 13 | $V_o = 0.6 V$ | 230 | μs |
| | | | $V_o = 1.0 V$ | 205 | |
| | | | $V_o = 3.3 V$ | 195 | |
| | | | $V_o = 5.0 V$ | 200 | |

| | | | | | |
|-------|--|-----------------------|---------|-----|---|
| f_s | Switching frequency | | 320 | kHz | |
| | Switching frequency range | PMBus configurable | 200-640 | kHz | |
| | Switching frequency set-point accuracy | | ± 5 | % | |
| | Control Circuit PWM Duty Cycle | | 5 | 95 | % |
| | Minimum Sync Pulse Width | | 150 | ns | |
| | Synchronization Frequency Tolerance | External clock source | -13 | 13 | % |

| | | | | | |
|---|-----------------------------|--------------------------|--------------------------|---------|---------|
| Input Under Voltage Lockout, UVLO | UVLO threshold | | 3.85 | V | |
| | UVLO threshold range | PMBus configurable | 3.85-14 | V | |
| | Set point accuracy | | -150 | 150 | mV |
| | UVLO hysteresis | | 0.35 | V | |
| | UVLO hysteresis range | PMBus configurable | 0-10.15 | V | |
| | Delay | | | 2.5 | μs |
| | Fault response | See Note 3 | Automatic restart, 70 ms | | |
| Input Over Voltage Protection, IOVP | IOVP threshold | | 16 | V | |
| | IOVP threshold range | PMBus configurable | 4.2-16 | V | |
| | Set point accuracy | | -150 | 150 | mV |
| | IOVP hysteresis | | 1 | V | |
| | IOVP hysteresis range | PMBus configurable | 0-11.8 | V | |
| | Delay | | | 2.5 | μs |
| | Fault response | See Note 3 | Automatic restart, 70 ms | | |
| Power Good, PG, See Note 2 | PG threshold | | 90 | % V_o | |
| | PG hysteresis | | 5 | % V_o | |
| | PG delay | | 10 | ms | |
| | PG delay range | PMBus configurable | 0-500 | S | |
| Output voltage Over/Under Voltage Protection, OVP/UVP | UVP threshold | | 85 | % V_o | |
| | UVP threshold range | PMBus configurable | 0-100 | % V_o | |
| | UVP hysteresis | | 5 | % V_o | |
| | OVP threshold | | 115 | % V_o | |
| | OVP threshold range | PMBus configurable | 100-115 | % V_o | |
| | UVP/OVP response time | | 25 | μs | |
| | UVP/OVP response time range | PMBus configurable | 5-60 | μs | |
| Fault response | See Note 3 | Automatic restart, 70 ms | | | |

BMR462 series PoL Regulators
Input 4.5-14 V, Output up to 12 A / 60 W

1/28701-BMR 462 Rev.A November 2017

© Flex

| Characteristics | | Conditions | min | typ | max | Unit |
|---|------------------------|--------------------|-----|---------------------------|-----|-----------------|
| Over Current Protection, OCP | OCP threshold | | | 18 | | A |
| | OCP threshold range | PMBus configurable | | 0-18 | | A |
| | Protection delay, | See Note 4 | | 5 | | T _{sw} |
| | Protection delay range | PMBus configurable | | 1-32 | | T _{sw} |
| | Fault response | See Note 3 | | Automatic restart, 70 ms | | |
| Over Temperature Protection, OTP at P1 See Note 9 | OTP threshold | | | 120 | | °C |
| | OTP threshold range | PMBus configurable | | -40...+120 | | °C |
| | OTP hysteresis | | | 15 | | °C |
| | OTP hysteresis range | PMBus configurable | | 0-160 | | °C |
| | Fault response | See Note 3 | | Automatic restart, 240 ms | | |

| | | | | | | | |
|-------------------|-------------------------------------|---|------|--|-----|-----|----|
| V _{IL} | Logic input low threshold | SYNC, SA0, SA1, SCL, SDA, GCB, CTRL, VSET | | | 0.8 | V | |
| V _{IH} | Logic input high threshold | | 2 | | | V | |
| I _{IL} | Logic input low sink current | CTRL | | | 0.6 | mA | |
| V _{OL} | Logic output low | SYNC, SCL, SDA, SALERT, GCB, PG | | | 0.4 | V | |
| V _{OH} | Logic output high | | 2.25 | | | V | |
| I _{OL} | Logic output low sink current | | | | | 4 | mA |
| I _{OH} | Logic output high source current | | | | | 2 | mA |
| t _{set} | Setup time, SMBus | See Note 1 | 300 | | | ns | |
| t _{hold} | Hold time, SMBus | See Note 1 | 250 | | | ns | |
| t _{free} | Bus free time, SMBus | See Note 1 | 2 | | | ms | |
| f _{SMB} | Supported SMBus Operating frequency | | 10 | | 100 | kHz | |
| C _p | Internal capacitance on logic pins | | | | 10 | pF | |

| | | | | | | | |
|--------------------------------------|-------------------------|---|--|----------|----------|----|----|
| Boot-up time | | See Note 11 | | 35 | | ms | |
| Output Voltage Delay Time See Note 6 | Delay duration | | | 10 | | ms | |
| | Delay duration range | PMBus configurable | | 2-500000 | | | |
| | Delay accuracy turn-on | Default configuration: CTRL controlled Precise timing enabled | | | ±0.25 | | ms |
| | | PMBus controlled Precise timing disabled | | | -0.25/+4 | | ms |
| | Delay accuracy turn-off | | | | -0.25/+4 | | ms |
| Output Voltage Ramp Time | Ramp duration | | | 10 | | ms | |
| | Ramp duration range | PMBus configurable | | 0-200 | | | |
| | Ramp time accuracy | | | | 100 | | µs |

| | | | | | | |
|---|---------------------------|--|------|-----|--|----|
| VTRK Input Bias Current | V _{VTRK} = 5.5 V | | 110 | 200 | | µA |
| VTRK Tracking Ramp Accuracy (V _O - V _{VTRK}) | 100% Tracking, see Note 8 | | -100 | 100 | | mV |
| VTRK Regulation Accuracy (V _O - V _{VTRK}) | 100% Tracking | | -1 | 1 | | % |

| | | | | | | | |
|---------------------|-----------------------------|--|--|---|------|---|---|
| Monitoring accuracy | READ_VIN vs V _I | | | 3 | | % | |
| | READ_VOUT vs V _O | | | 1 | | % | |
| | READ_IOUT vs I _O | I _O = 0-12 A, T _{P1} = 0 to +95°C V _I = 12 V | | | ±1.6 | | A |
| | READ_IOUT vs I _O | I _O = 0-12 A, T _{P1} = 0 to +95°C V _I = 4.5-14 V | | | ±2.7 | | A |

Note 1: See section I2C/SMBus Setup and Hold Times – Definitions.

Note 2: Monitorable over PMBus Interface.

Note 3: Automatic restart ~70 or 240 ms after fault if the fault is no longer present. Continuous restart attempts if the fault reappear after restart. See Operating Information for other fault response options.

Note 4: T_{sw} is the switching period.

Note 5: Within +/-3% of V_O

Note 6: See section Soft-start Power Up.

Note 8: Tracking functionality is designed to follow a VTRK signal with slewrates < 2.4V/ms. For faster VTRK signals accuracy will depend on the regulator bandwidth.

Note 9: See section Over Temperature Protection (OTP).

Note 10: See section External Capacitors.

Note 11: See section Start-Up Procedure.

Note 12: See graph Output Ripple vs External Capacitance and Operating information section Output Ripple and Noise.

Note 13: See graph Load Transient vs. External Capacitance and Operating information section External Capacitors.

Note 14: Time for reaching 100% of nominal V_{out}.

Note 15: For V_{out} < 1.0V accuracy is +/-10 mV. For further deviations see section Output Voltage Adjust using PMBus.

Note 17: Without minimum load the monitoring function will cause an output voltage of ~0.6 V when the output is disabled. This does not apply if Low Power mode is used.

BMR462 series PoL Regulators
 Input 4.5-14 V, Output up to 12 A / 60 W

1/28701-BMR 462 Rev.A November 2017

© Flex

Typical Characteristics
Efficiency and Power Dissipation

BMR 462 2002 (SIP)

Efficiency vs. Output Current, $V_I=5\text{ V}$

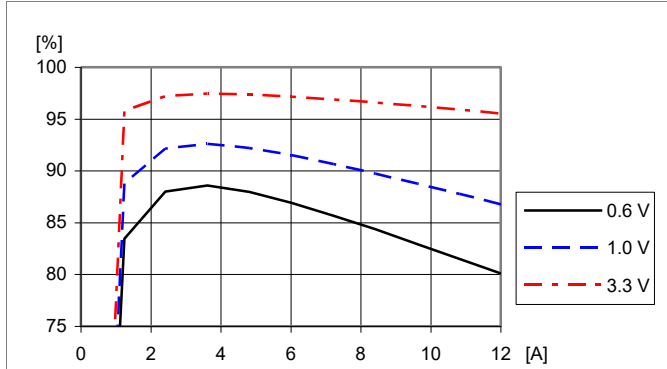

Efficiency vs. load current and output voltage:
 $T_{P1} = +25^\circ\text{C}$, $V_I=5\text{ V}$, $f_{sw}=320\text{ kHz}$, $C_O=470\text{ }\mu\text{F}/10\text{ m}\Omega$.

Power Dissipation vs. Output Current, $V_I=5\text{ V}$

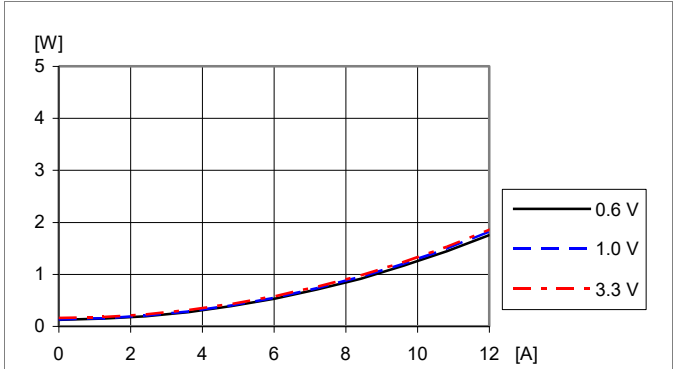

Dissipated power vs. load current and output voltage:
 $T_{P1} = +25^\circ\text{C}$, $V_I=5\text{ V}$, $f_{sw}=320\text{ kHz}$, $C_O=470\text{ }\mu\text{F}/10\text{ m}\Omega$.

Efficiency vs. Output Current, $V_I=12\text{ V}$

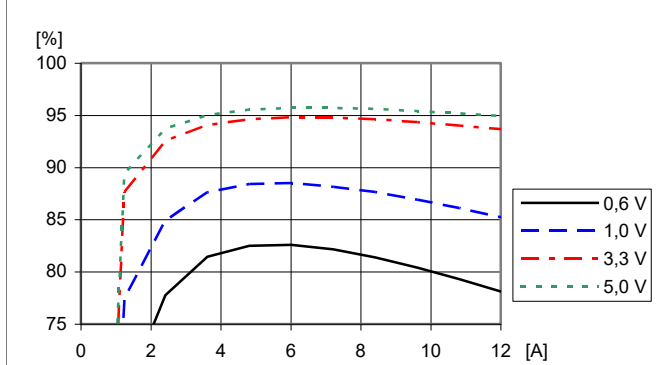

Efficiency vs. load current and output voltage at
 $T_{P1} = +25^\circ\text{C}$, $V_I=12\text{ V}$, $f_{sw}=320\text{ kHz}$, $C_O=470\text{ }\mu\text{F}/10\text{ m}\Omega$.

Power Dissipation vs. Output Current, $V_I=12\text{ V}$

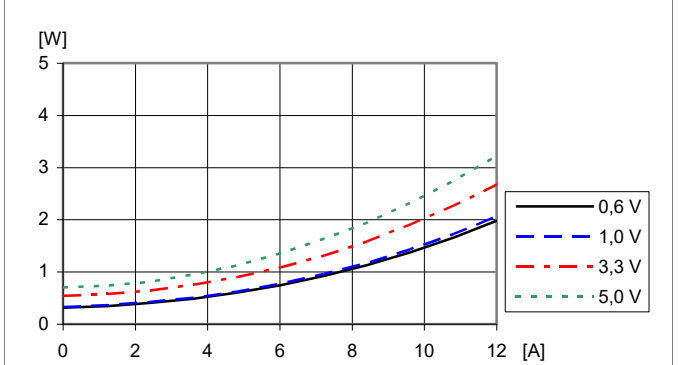

Dissipated power vs. load current and output voltage:
 $T_{P1} = +25^\circ\text{C}$, $V_I=12\text{ V}$, $f_{sw}=320\text{ kHz}$, $C_O=470\text{ }\mu\text{F}/10\text{ m}\Omega$.

Efficiency vs. Output Current and Switch Frequency

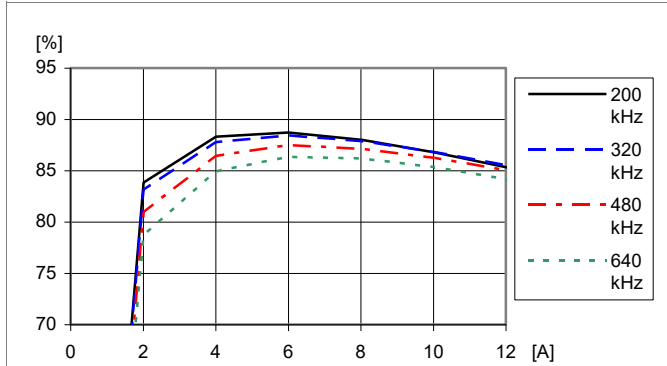

Efficiency vs. load current and switch frequency at
 $T_{P1} = +25^\circ\text{C}$, $V_I=12\text{ V}$, $V_O=1.0\text{ V}$, $C_O=470\text{ }\mu\text{F}/10\text{ m}\Omega$
 Default configuration except changed frequency

Power Dissipation vs. Output Current and Switch Frequency

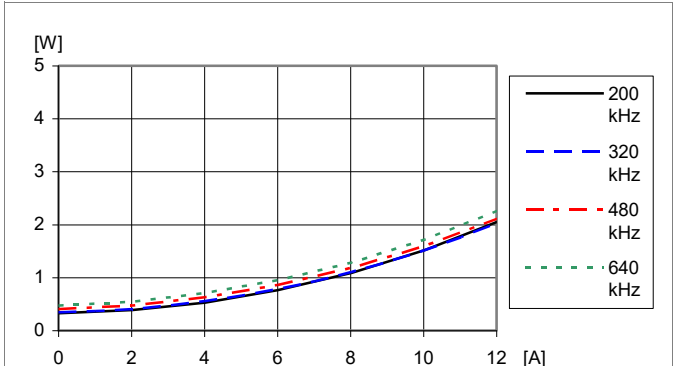

Dissipated power vs. load current and switch frequency at
 $T_{P1} = +25^\circ\text{C}$, $V_I=12\text{ V}$, $V_O=1.0\text{ V}$, $C_O=470\text{ }\mu\text{F}/10\text{ m}\Omega$
 Default configuration except changed frequency

BMR462 series PoL Regulators
 Input 4.5-14 V, Output up to 12 A / 60 W

1/28701-BMR 462 Rev.A November 2017

© Flex

Typical Characteristics
Load Transient

BMR 462 2002 (SIP)

Load Transient vs. External Capacitance, $V_o=1.0\text{ V}$

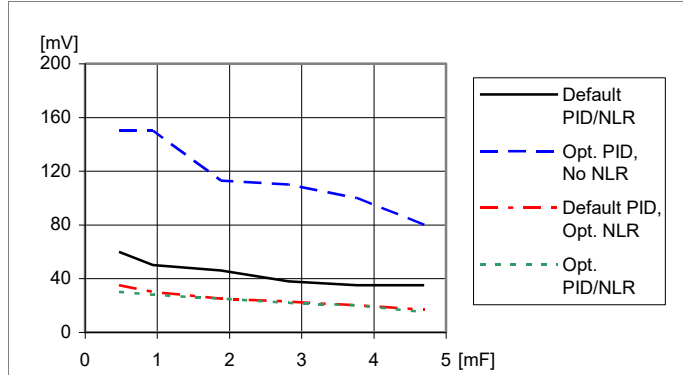

Load transient peak voltage deviation vs. external capacitance. Step-change (3-9-3 A). Parallel coupling of capacitors with 470 $\mu\text{F}/10\text{ m}\Omega$, $T_{P1} = +25^\circ\text{C}$. $V_i=12\text{ V}$, $V_o=1.0\text{ V}$, $f_{sw}=320\text{ kHz}$, $di/dt=2\text{ A}/\mu\text{s}$

Load Transient vs. External Capacitance, $V_o=3.3\text{ V}$

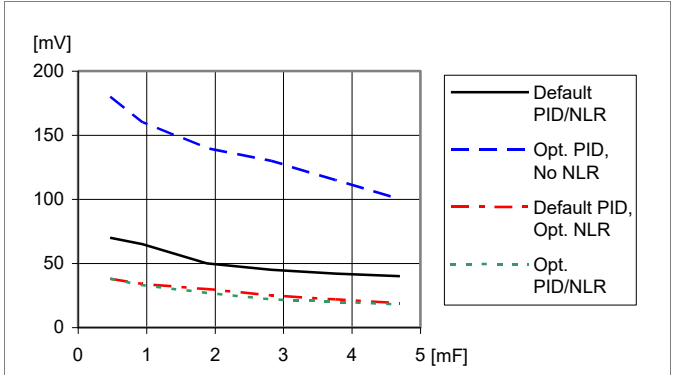

Load transient peak voltage deviation vs. external capacitance. Step-change (3-9-3 A). Parallel coupling of capacitors with 470 $\mu\text{F}/10\text{ m}\Omega$, $T_{P1} = +25^\circ\text{C}$. $V_i=12\text{ V}$, $V_o=3.3\text{ V}$, $f_{sw}=320\text{ kHz}$, $di/dt=2\text{ A}/\mu\text{s}$

Load transient vs. Switch Frequency

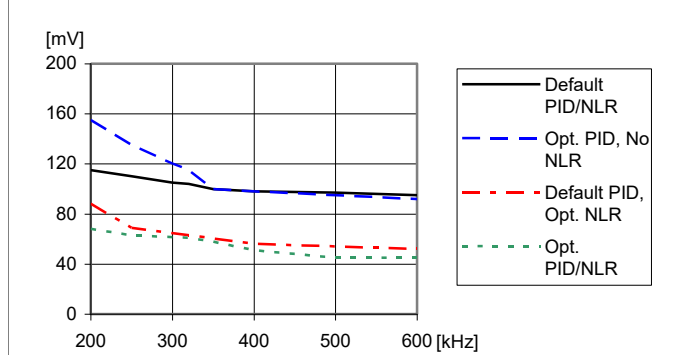

Load transient peak voltage deviation vs. frequency. Step-change (3-9-3 A). $T_{P1} = +25^\circ\text{C}$. $V_i=12\text{ V}$, $V_o=3.3\text{ V}$, $C_o=470\text{ }\mu\text{F}/10\text{ m}\Omega$

Output Load Transient Response, Default PID/NLR

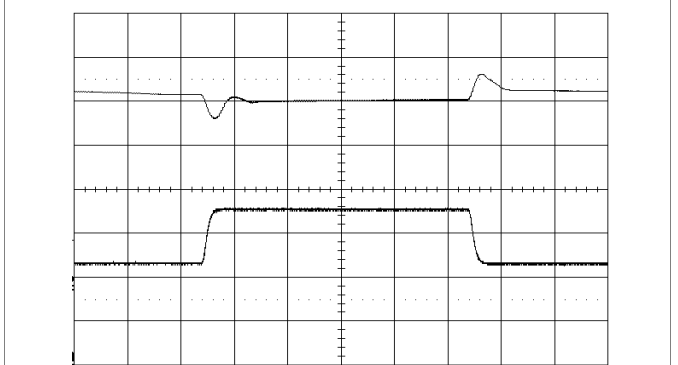

Output voltage response to load current step-change (3-9-3 A) at: $T_{P1} = +25^\circ\text{C}$, $V_i = 12\text{ V}$, $V_o = 3.3\text{ V}$, $di/dt=2\text{ A}/\mu\text{s}$, $f_{sw}=320\text{ kHz}$, $C_o=470\text{ }\mu\text{F}/10\text{ m}\Omega$

Top trace: output voltage (200 mV/div.). Bottom trace: load current (10 A/div.). Time scale: (0.1 ms/div.).

BMR462 series PoL Regulators
 Input 4.5-14 V, Output up to 12 A / 60 W

1/28701-BMR 462 Rev.A November 2017
 © Flex

Typical Characteristics
Output Current Characteristic

BMR 462 2002 (SIP)

Output Current Derating, $V_O=0.6\text{ V}$

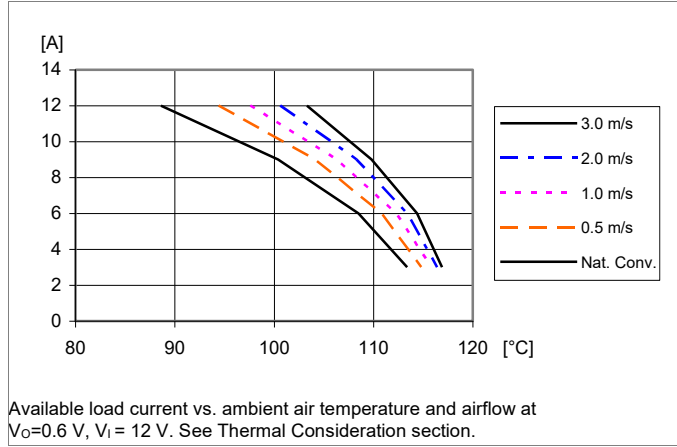

Output Current Derating, $V_O=1.0\text{ V}$

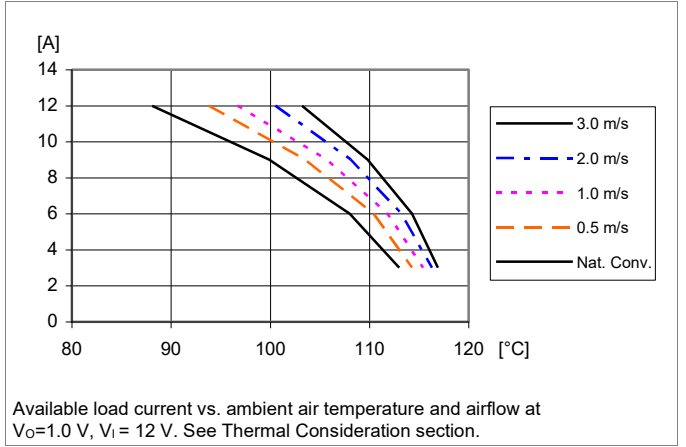

Output Current Derating, $V_O=3.3\text{ V}$

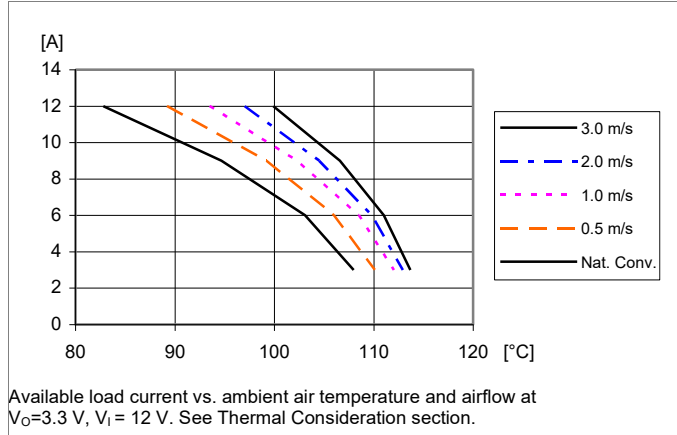

Output Current Derating, $V_O=5.0\text{ V}$

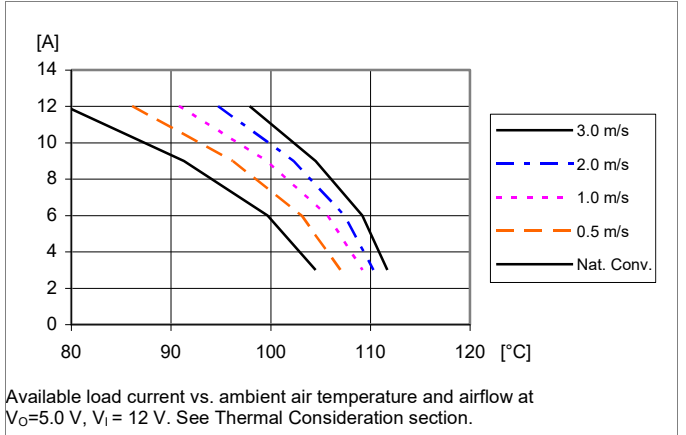

Current Limit Characteristics, $V_O=1.0\text{ V}$

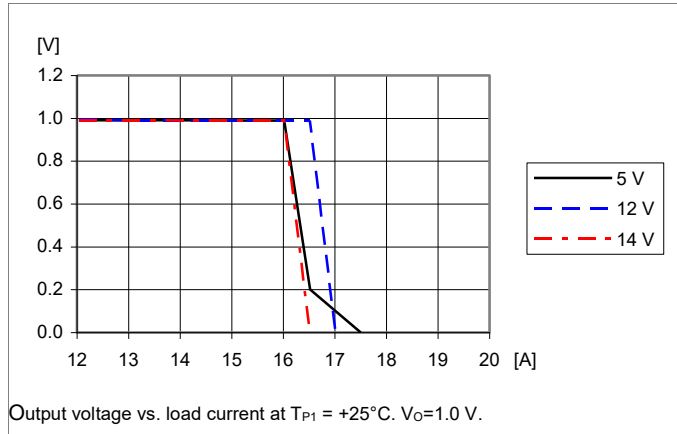

Current Limit Characteristics, $V_O=3.3\text{ V}$

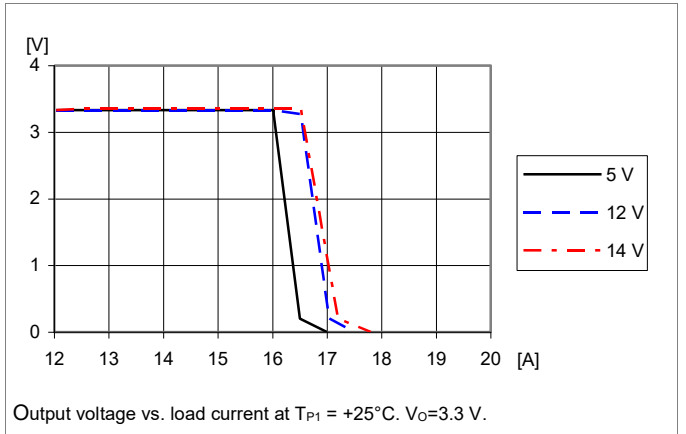

BMR462 series PoL Regulators
 Input 4.5-14 V, Output up to 12 A / 60 W

1/28701-BMR 462 Rev.A November 2017
 © Flex

Typical Characteristics
Output Voltage

BMR 462 2002 (SIP)

Output Ripple & Noise, $V_o=1.0\text{ V}$

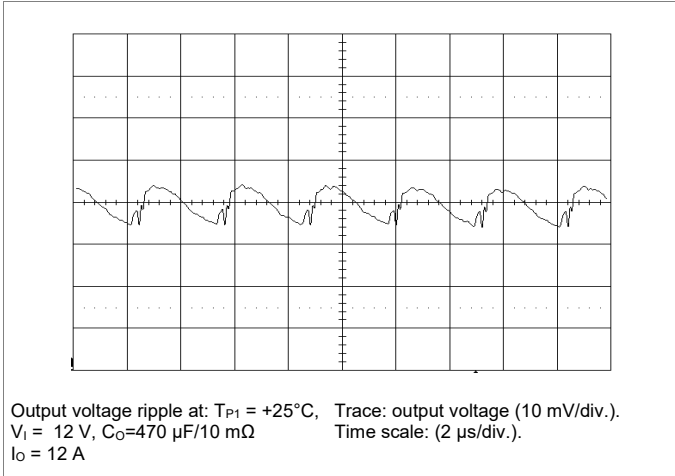

Output Ripple & Noise, $V_o=3.3\text{ V}$

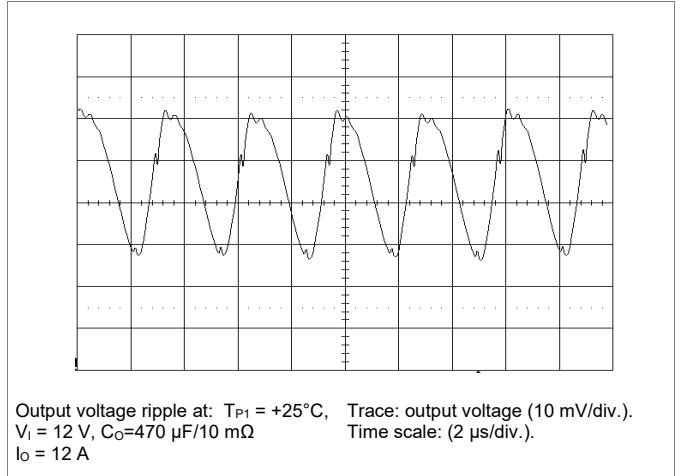

Output Ripple vs. Input Voltage

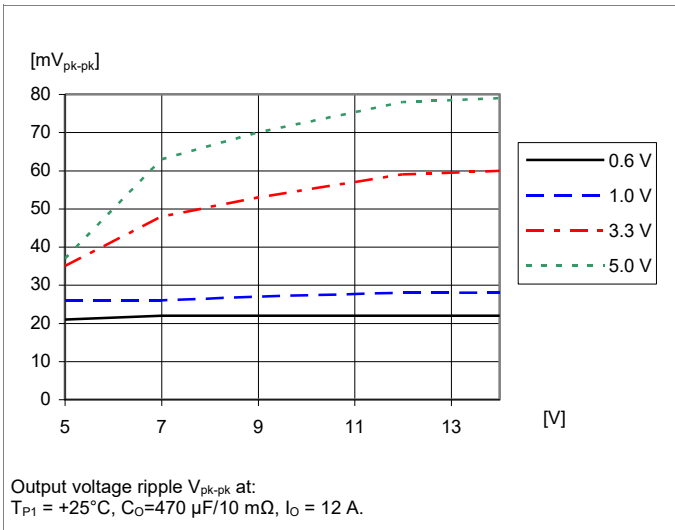

Output Ripple vs. Frequency

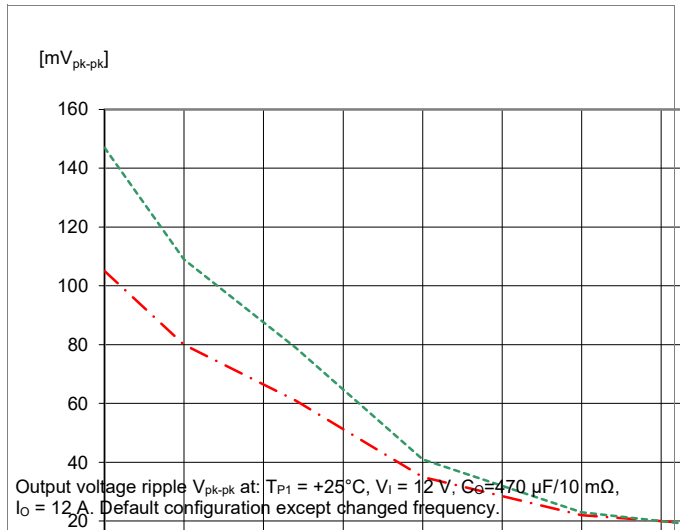

Output Ripple vs. External Capacitance

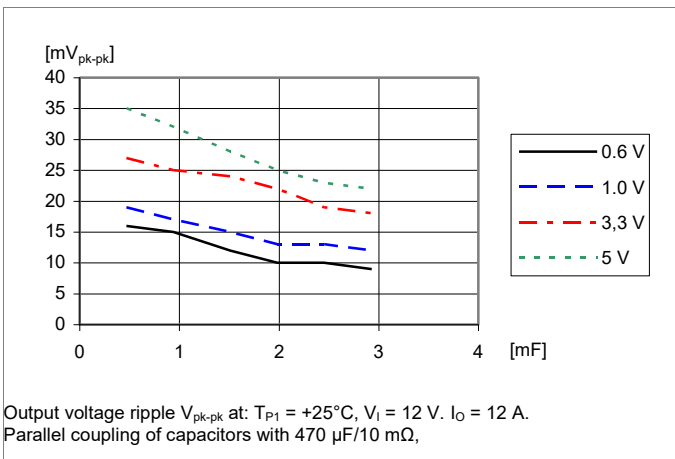

Load regulation, $V_o=3.3\text{ V}$

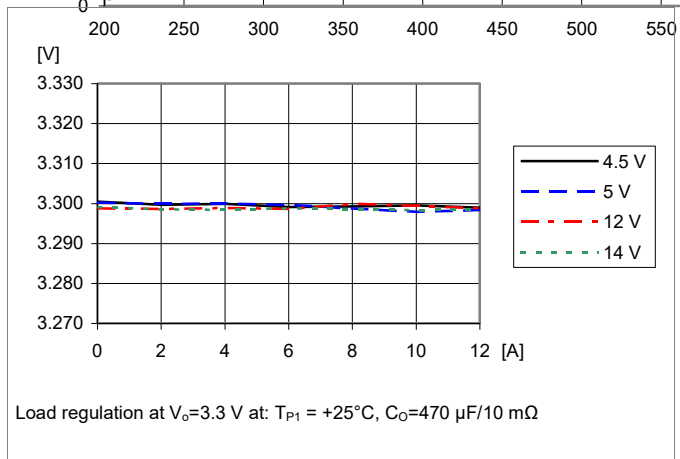

BMR462 series PoL Regulators
 Input 4.5-14 V, Output up to 12 A / 60 W

1/28701-BMR 462 Rev.A November 2017

© Flex

Typical Characteristics
Start-up and shut-down

BMR 462 2002 (SIP)

Start-up by input source

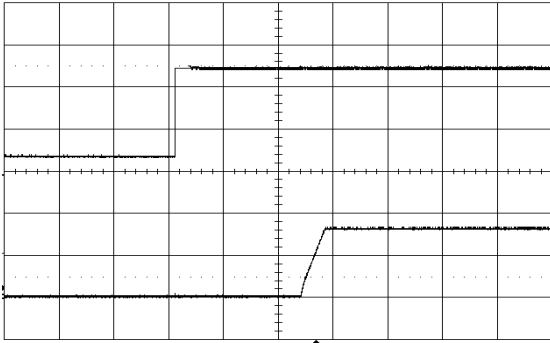

Start-up enabled by connecting V_I at:
 $T_{P1} = +25^\circ\text{C}$, $V_I = 12\text{ V}$, $V_O = 3.3\text{ V}$
 $C_O = 470\ \mu\text{F}/10\ \text{m}\Omega$, $I_O = 12\ \text{A}$
 Top trace: Input voltage (5 V/div.).
 Bottom trace: Output voltage (2 V/div.).
 Time scale: (20 ms/div.).

Shut-down by input source

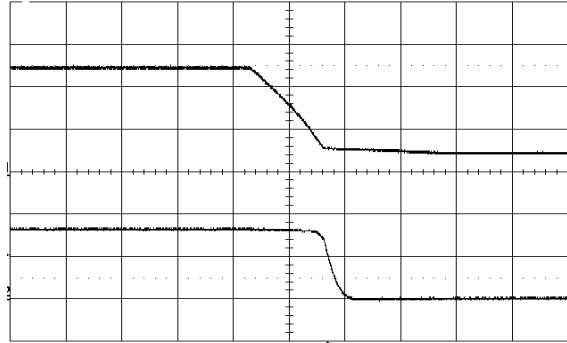

Shut-down enabled by disconnecting V_I at:
 $T_{P1} = +25^\circ\text{C}$, $V_I = 12\text{ V}$, $V_O = 3.3\text{ V}$
 $C_O = 470\ \mu\text{F}/10\ \text{m}\Omega$, $I_O = 12\ \text{A}$
 Top trace: Input voltage (5 V/div.).
 Bottom trace: Output voltage (2 V/div.).
 Time scale: (2 ms/div.).

Start-up by CTRL signal

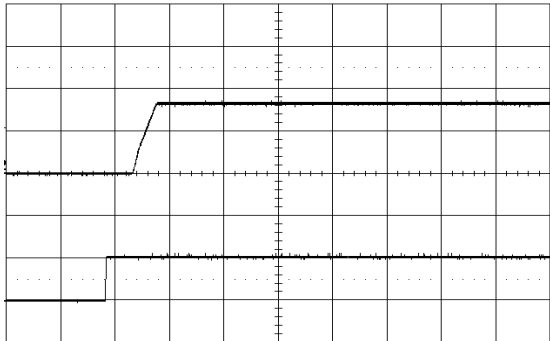

Start-up enabled by connecting V_I at:
 $T_{P1} = +25^\circ\text{C}$, $V_I = 12\text{ V}$, $V_O = 3.3\text{ V}$
 $C_O = 470\ \mu\text{F}/10\ \text{m}\Omega$, $I_O = 12\ \text{A}$
 Top trace: output voltage (2 V/div.).
 Bottom trace: CTRL signal (2 V/div.).
 Time scale: (20 ms/div.).

Shut-down by CTRL signal

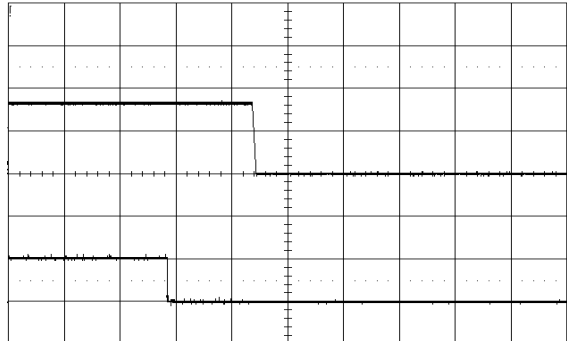

Shut-down enabled by disconnecting V_I at:
 $T_{P1} = +25^\circ\text{C}$, $V_I = 12\text{ V}$, $V_O = 3.3\text{ V}$
 $C_O = 470\ \mu\text{F}/10\ \text{m}\Omega$, $I_O = 12\ \text{A}$
 Top trace: output voltage (2 V/div.).
 Bottom trace: CTRL signal (2 V/div.).
 Time scale: (2 ms/div.).

BMR462 series PoL Regulators
 Input 4.5-14 V, Output up to 12 A / 60 W

1/28701-BMR 462 Rev.A November 2017

© Flex

EMC Specification

Conducted EMI measured according to test set-up below. The fundamental switching frequency is 320 kHz at $V_I = 12\text{ V}$, max I_O .

Conducted EMI Input terminal value (typical for default configuration)

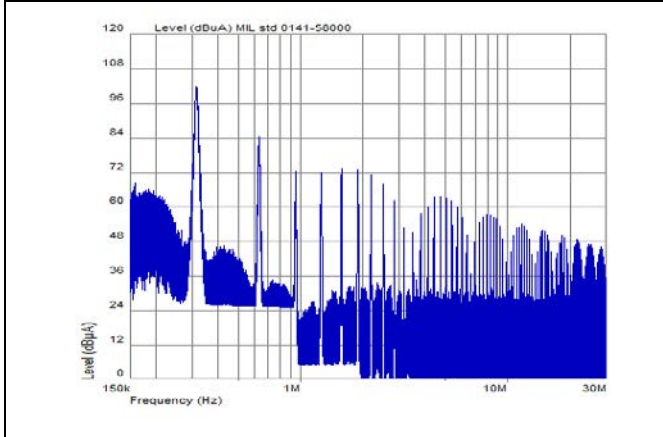

EMI without filter

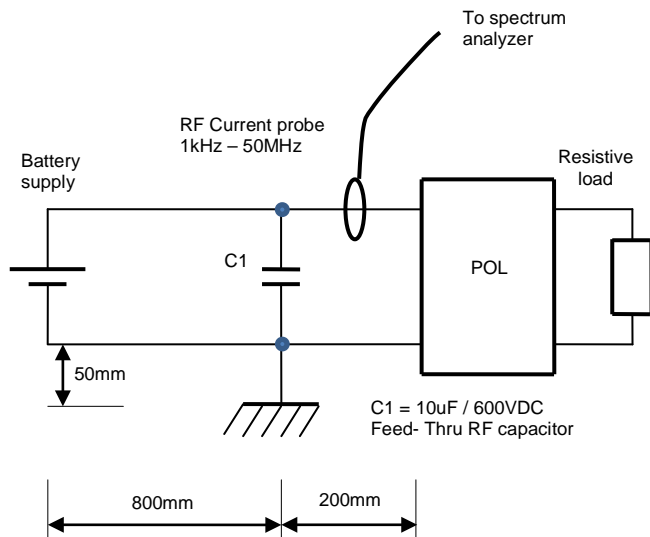

Conducted EMI test set-up

Layout Recommendations

The radiated EMI performance of the product will depend on the PWB layout and ground layer design. It is also important to consider the stand-off of the product. If a ground layer is used, it should be connected to the output of the product and the equipment ground or chassis.

A ground layer will increase the stray capacitance in the PWB and improve the high frequency EMC performance.

Output Ripple and Noise

Output ripple and noise is measured according to figure below. A 50 mm conductor works as a small inductor forming together with the two capacitances a damped filter.

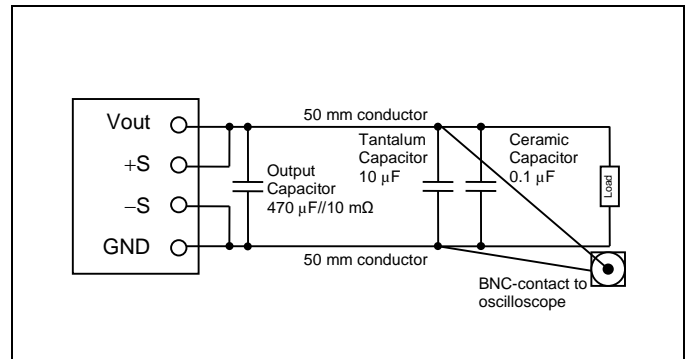

Output ripple and noise test set-up.

Operating information

Power Management Overview

This product is equipped with a PMBus interface. The product incorporates a wide range of readable and configurable power management features that are simple to implement with a minimum of external components. Additionally, the product includes protection features that continuously safeguard the load from damage due to unexpected system faults. A fault is also shown as an alert on the SALERT pin. The following product parameters can continuously be monitored by a host: Input voltage, output voltage/current, and internal temperature. If the monitoring is not needed it can be disabled and the product enters a low power mode reducing the power consumption. The protection features are not affected.

The product is delivered with a default configuration suitable for a wide range operation in terms of input voltage, output voltage, and load. The configuration is stored in an internal Non-Volatile Memory (NVM). All power management functions can be reconfigured using the PMBus interface. Throughout this document, different PMBus commands are referenced. A detailed description of each command is provided in the appendix at the end of this specification. The Flex Power Designer software suite can be used to configure and monitor this product via the PMBus interface. For more information please contact your local Flex sales representative.

Input Voltage

The input voltage range, 4.5 - 14 V, makes the product easy to use in intermediate bus applications when powered by a non-regulated bus converter or a regulated bus converter. See Ordering Information for input voltage range.

Input Under Voltage Lockout, UVLO

The product monitors the input voltage and will turn-on and

BMR462 series PoL Regulators

Input 4.5-14 V, Output up to 12 A / 60 W

1/28701-BMR 462 Rev.A November 2017

© Flex

turn-off at configured levels. The default turn-on input voltage level setting is 4.20 V, whereas the corresponding turn-off input voltage level is 3.85 V. Hence, the default hysteresis between turn-on and turn-off input voltage is 0.35 V. Once an input turn-off condition occurs, the device can respond in a number of ways as follows:

1. Continue operating without interruption. The unit will continue to operate as long as the input voltage can be supported. If the input voltage continues to fall, there will come a point where the unit will cease to operate.
2. Continue operating for a given delay period, followed by shutdown if the fault still exists. The device will remain in shutdown until instructed to restart.
3. Initiate an immediate shutdown until the fault has been cleared. The user can select a specific number of retry attempts.

The default response from a turn-off is an immediate shutdown of the device. The device will continuously check for the presence of the fault condition. If the fault condition is no longer present, the product will be re-enabled. The turn-on and turn-off levels and response can be reconfigured using the PMBus interface.

Remote Control

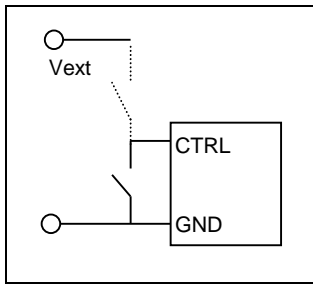

The product is equipped with a remote control function, i.e., the CTRL pin. The remote control can be connected to either the primary negative input connection (GND) or an external voltage (V_{ext}), which is a 3 – 5.5 V positive supply voltage in accordance to the SMBus Specification version 3.0.

The CTRL function allows the product to be turned on/off by an external device like a semiconductor or mechanical switch. By default the product will turn on when the CTRL pin is left open and turn off when the CTRL pin is applied to GND. The CTRL pin has an internal pull-up resistor. When the CTRL pin is left open, the voltage generated on the CTRL pin is max 5.5 V. If the device is to be synchronized to an external clock source, the clock frequency must be stable prior to asserting the CTRL pin.

The product can also be configured using the PMBus interface to be “Always on”, or turn on/off can be performed with PMBus commands.

Input and Output Impedance

The impedance of both the input source and the load will interact with the impedance of the product. It is important that the input source has low characteristic impedance. The performance in some applications can be enhanced by addition of external capacitance as described under External Decoupling Capacitors. If the input voltage source contains significant inductance, the addition a capacitor with low ESR at the input of the product will ensure stable operation.

External Capacitors

Input capacitors:

The input ripple RMS current in a buck converter is equal to

$$\text{Eq. 1. } I_{inputRMS} = I_{load} \sqrt{D(1-D)},$$

where I_{load} is the output load current and D is the duty cycle.

The maximum load ripple current becomes $I_{load}/2$. The ripple current is divided into three parts, i.e., currents in the input source, external input capacitor, and internal input capacitor. How the current is divided depends on the impedance of the input source, ESR and capacitance values in the capacitors. A minimum capacitance of 300 μF with low ESR is recommended. The ripple current rating of the capacitors must follow Eq. 1. For high-performance/transient applications or wherever the input source performance is degraded, additional low ESR ceramic type capacitors at the input is recommended. The additional input low ESR capacitance above the minimum level insures an optimized performance.

Throughout this document, different PMBus commands are referenced. A detailed description of each command is provided in the appendix at the end of this specification. The Flex Power Designer software suite can be used to configure and monitor this product via the PMBus interface. For more information please contact your local Flex sales representative.

Output capacitors:

When powering loads with significant dynamic current requirements, the voltage regulation at the point of load can be improved by addition of decoupling capacitors at the load. The most effective technique is to locate low ESR ceramic and electrolytic capacitors as close to the load as possible, using several capacitors in parallel to lower the effective ESR. The ceramic capacitors will handle high-frequency dynamic load changes while the electrolytic capacitors are used to handle low frequency dynamic load changes. Ceramic capacitors will also reduce high frequency noise at the load.

It is equally important to use low resistance and low inductance PWB layouts and cabling.

External decoupling capacitors are a part of the control loop of the product and may affect the stability margins.

Stable operation is guaranteed for the following total capacitance C_O in the output decoupling capacitor bank where

$$\text{Eq. 2. } C_O = [C_{min}, C_{max}] = [300, 7500] \mu\text{F}.$$

The decoupling capacitor bank should consist of capacitors which have a capacitance value larger than $C \geq C_{min}$ and has an ESR range of

$$\text{Eq. 3. } ESR = [ESR_{min}, ESR_{max}] = [5, 30] \text{ m}\Omega$$

The control loop stability margins are limited by the minimum time constant τ_{min} of the capacitors. Hence, the time constant of the capacitors should follow Eq. 4.

$$\text{Eq. 4. } \tau \geq \tau_{min} = C_{min} ESR_{min} = 1.5 \mu\text{s}$$

This relation can be used if your preferred capacitors have

BMR462 series PoL Regulators
Input 4.5-14 V, Output up to 12 A / 60 W

1/28701-BMR 462 Rev.A November 2017
© Flex

parameters outside the above stated ranges in Eq. 2 and Eq.3.

- If the capacitors capacitance value is $C < C_{min}$ one must use at least N capacitors where

$$N \geq \left\lceil \frac{C_{min}}{C} \right\rceil \text{ and } ESR \geq ESR_{min} \frac{C_{min}}{C} .$$
- If the ESR value is $ESR > ESR_{max}$ one must use at least N capacitors of that type where

$$N \geq \left\lceil \frac{ESR}{ESR_{max}} \right\rceil \text{ and } C \geq \frac{C_{min}}{N} .$$
- If the ESR value is $ESR < ESR_{min}$ the capacitance value should be

$$C \geq C_{min} \frac{ESR_{min}}{ESR} .$$

For a total capacitance outside the above stated range or capacitors that do not follow the stated above requirements above a re-design of the control loop parameters will be necessary for robust dynamic operation and stability. Optimization of output filter together with load step simulations can be made using the Flex Power Designer software. See application note AN321 for further guidelines on how to choose and apply output capacitors.

Control Loop Compensation

The product is configured with a robust control loop compensation which allows for a wide range operation of input and output voltages and capacitive loads as defined in the section External Decoupling Capacitors. For an application with a specific input voltage, output voltage, and capacitive load, the control loop can be optimized for a robust and stable operation and with an improved load transient response. This optimization will minimize the amount of required output decoupling capacitors for a given load transient requirement yielding an optimized cost and minimized board space. The control loop parameters can be reconfigured using the PMBus interface.

Load Transient Response Optimization

The product incorporates a Non-Linear transient Response, NLR, loop that decreases the response time and the output voltage deviation during a load transient. The NLR results in a higher equivalent loop bandwidth than is possible using a traditional linear control loop. The product is pre-configured with appropriate NLR settings for robust and stable operation for a wide range of input voltage and a capacitive load range as defined in the section External Decoupling Capacitors. For an application with a specific input voltage, output voltage, and capacitive load, the NLR configuration can be optimized for a robust and stable operation and with an improved load transient response. This will also reduce the amount of output decoupling capacitors and yield a reduced cost. However, the NLR slightly reduces the efficiency. In order to obtain maximal energy efficiency the load transient requirement has to be met by the standard control loop compensation and the decoupling capacitors. The NLR settings can be reconfigured using the PMBus interface.

See application note AN306 for further information.

Remote Sense

The product has remote sense that can be used to compensate for voltage drops between the output and the point of load. The sense traces should be located close to the PWB ground layer to reduce noise susceptibility. Due to derating of internal output capacitance the voltage drop should be kept below $V_{DROPMAX} = (5.5 - V_{OUT}) / 2$. A large voltage drop will impact the electrical performance of the regulator. If the remote sense is not needed +S should be connected to VOUT and -S should be connected to GND.

Output Voltage Adjust using Pin-strap Resistor

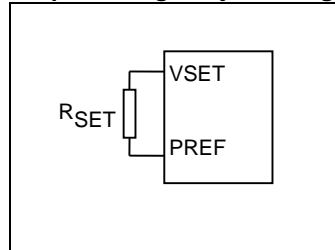

Using an external Pin-strap resistor, R_{SET} , the output voltage can be set in the range 0.6 V to 3.3 V at 28 different levels shown in the table below. The resistor should be applied between the VSET pin and the PREF pin.

R_{SET} also sets the maximum output voltage, see section "Output Voltage Range Limitation". The resistor is sensed only during product start-up. Changing the resistor value during normal operation will not change the output voltage. The input voltage must be at least 1 V larger than the output voltage in order to deliver the correct output voltage. See Ordering Information for output voltage range.

The following table shows recommended resistor values for R_{SET} . Maximum 1% tolerance resistors are required.

| V_{OUT} [V] | R_{SET} [kΩ] | V_{OUT} [V] | R_{SET} [kΩ] |
|---------------|----------------|---------------|----------------|
| 0.60 | 10 | 1.50 | 46.4 |
| 0.65 | 11 | 1.60 | 51.1 |
| 0.70 | 12.1 | 1.70 | 56.2 |
| 0.75 | 13.3 | 1.80 | 61.9 |
| 0.80 | 14.7 | 1.90 | 68.1 |
| 0.85 | 16.2 | 2.00 | 75 |
| 0.90 | 17.8 | 2.10 | 82.5 |
| 0.95 | 19.6 | 2.20 | 90.9 |
| 1.00 | 21.5 | 2.30 | 100 |
| 1.05 | 23.7 | 2.50 | 110 |
| 1.10 | 26.1 | 3.00 | 121 |
| 1.15 | 28.7 | 3.30 | 133 |
| 1.20 | 31.6 | 4.00 | 147 |
| 1.25 | 34.8 | 5.00 | 162 |
| 1.30 | 38.3 | 5.50 | 178 |
| 1.40 | 42.2 | | |

BMR462 series PoL Regulators

Input 4.5-14 V, Output up to 12 A / 60 W

1/28701-BMR 462 Rev.A November 2017

© Flex

The output voltage and the maximum output voltage can be pin strapped to three fixed values by connecting the VSET pin according to the table below.

| V _{OUT} [V] | VSET |
|----------------------|------------------------------|
| 0.60 | Shorted to PREF |
| 1.2 | Open "high impedance" |
| 2.5 | Logic High, GND as reference |

Output Voltage Adjust using PMBus

The output voltage set by pin-strap can be overridden up to a certain level (see section Output Voltage Range Limitation) by using the PMBus command VOUT_COMMAND. See Electrical Specification for adjustment range. Make sure a new VOUT_COMMAND is not sent 15 ms prior to enabling the output, until after power good (PG) is asserted.

When setting the output voltage by configuration file or by a PMBus command, the specified output voltage accuracy is valid only when the set output voltage level falls within the same bin range as the voltage level defined by the pin-strap resistor R_{SET}. The applicable bin ranges are defined in the table below. Valid accuracy for voltage levels outside the applicable bin range is two times the specified.

Example:

Nominal V_{out} is set to 1.10V by R_{set}=26.1kohm. 1.10V falls within the bin range 0.988-1.383V, thus specified accuracy is valid when adjusting V_{out} within 0.988-1.383V.

| V _{OUT} bin ranges [V] |
|---------------------------------|
| 0 – 0.988 |
| 0.988 – 1.383 |
| 1.383 – 1.975 |
| 1.975 – 2.398 |
| 2.398 – 2.963 |
| 2.963 – 3.753 |
| 3.753 – 4.938 |
| 4.938 – |

Output Voltage Range Limitation

The output voltage range that is possible to set by configuration or by the PMBus interface is limited by the pin-strap resistor R_{SET}. The maximum output voltage is set to 110% of the nominal output value defined by R_{SET}, $V_{OUT_MAX} = 1.1 \times V_{OUT_RSET}$. This protects the load from an over voltage due to an accidental wrong PMBus command.

Over Voltage Protection (OVP)

The product includes over voltage limiting circuitry for protection of the load. The default OVP limit is 15% above the nominal output voltage. If the output voltage exceeds the OVP limit, the product can respond in different ways:

1. Initiate an immediate shutdown until the fault has been cleared. The user can select a specific number of retry attempts.
2. Turn off the high-side MOSFET and turn on the low-side MOSFET. The low-side MOSFET remains ON until the device attempts a restart, i.e. the output voltage is pulled to ground level (crowbar function).

The default response from an overvoltage fault is to immediately shut down as in 2. The device will continuously check for the presence of the fault condition, and when the fault condition no longer exists the device will be re-enabled. For continuous OVP when operating from an external clock for synchronization, the only allowed response is an immediate shutdown. The OVP limit and fault response can be reconfigured using the PMBus interface.

Under Voltage Protection (UVP)

The product includes output under voltage limiting circuitry for protection of the load. The default UVP limit is 15% below the nominal output voltage. The UVP limit can be reconfigured using the PMBus interface.

Power Good

The product provides a Power Good (PG) flag in the Status Word register that indicates the output voltage is within a specified tolerance of its target level and no fault condition exists. If specified in section Connections, the product also provides a PG signal output. The PG pin is active high and by default open-drain but may also be configured as push-pull via the PMBus interface.

By default, the PG signal will be asserted when the output reaches above 90% of the nominal voltage, and de-asserted when the output falls below 85% of the nominal voltage. These limits may be changed via the PMBus interface. A PG delay period is defined as the time from when all conditions within the product for asserting PG are met to when the PG signal is actually asserted. The default PG delay is set to 10 ms. This value can be reconfigured using the PMBus interface.

Switching Frequency

The fundamental switching frequency is 320 kHz, which yields optimal power efficiency. The switching frequency can be set to any value between 200 kHz and 640 kHz using the PMBus interface. The switching frequency will change the efficiency/power dissipation, load transient response and output ripple. For optimal control loop performance the control loop must be re-designed when changing the switching frequency.

Synchronization

Synchronization is a feature that allows multiple products to be synchronized to a common frequency. Synchronized products powered from the same bus eliminate beat frequencies reflected back to the input supply, and also reduces EMI filtering requirements. Eliminating the slow beat frequencies (usually <10 kHz) allows the EMI filter to be designed to attenuate only the synchronization frequency. Synchronization

| | |
|---|--|
| BMR462 series PoL Regulators Input 4.5-14 V, Output up to 12 A / 60 W | 1/28701-BMR 462 Rev.A November 2017 |
| © Flex | |

can also be utilized for phase spreading, described in section Phase Spreading.

The products can be synchronized with an external oscillator or one product can be configured with the SYNC pin as a SYNC Output working as a master driving the synchronization. All others on the same synchronization bus should be configured with SYNC Input or SYNC Auto Detect (Default configuration) for correct operation. When the SYNC pin is configured in auto detect mode the product will automatically check for a clock signal on the SYNC pin.

See application note AN309 for further information.

Phase Spreading

When multiple products share a common DC input supply, spreading of the switching clock phase between the products can be utilized. This dramatically reduces input capacitance requirements and efficiency losses, since the peak current drawn from the input supply is effectively spread out over the whole switch period. This requires that the products are synchronized. Up to 16 different phases can be used. The phase spreading of the product can be configured using the PMBus interface.

See application note AN309 for further information.

Adaptive Diode Emulation

Most power converters use synchronous rectification to optimize efficiency over a wide range of input and output conditions. However, at light loads the synchronous MOSFET will typically sink current and introduce additional energy losses associated with higher peak inductor currents, resulting in reduced efficiency. Adaptive diode emulation mode turns off the low-side FET gate drive at low load currents to prevent the inductor current from going negative, reducing the energy losses and increasing overall efficiency. Diode emulation is not available for current sharing groups. Note: the overall bandwidth of the product may be reduced when in diode emulation mode. It is recommended that diode emulation is disabled prior to applying significant load steps. The diode emulation mode can be configured using the PMBus interface.

Adaptive Frequency and Pulse Skip Control

Since switching losses contribute to the efficiency of the power converter, reducing the switching frequency will reduce the switching losses and increase efficiency. The product includes an Adaptive Frequency Control mode, which effectively reduces the observed switching frequency as the load decreases. Adaptive frequency mode is only available while the device is operating within Adaptive Diode Emulation Mode. As the load current is decreased, diode emulation mode decreases the Synch-FET on-time to prevent negative inductor current from flowing. As the load is decreased further, the Switch-FET pulse width will begin to decrease while maintaining the programmed frequency, f_{PROG} (set by the `FREQ_SWITCH` command). Once the Switch-FET pulse width (D) reaches 50% of the nominal duty cycle, D_{NOM} (determined by V_I and V_O), the switching frequency will start to decrease according to the following equation:

$$f_{sw} = D \left(\frac{2(f_{PROG} - f_{MIN})}{D_{NOM}} \right) + f_{MIN}$$

Eq. 5.

Disabling a minimum Synch-FET makes the product also pulse skip which reduces the power loss further.

It should be noted that adaptive frequency mode is not available for current sharing groups and is not allowed when the device is placed in auto-detect mode and a clock source is present on the SYNC pin, or if the device is outputting a clock signal on its SYNC pin. The adaptive frequency and pulse skip modes can be configured using the PMBus interface.

Efficiency Optimized Dead Time Control

The product utilizes a closed loop algorithm to optimize the dead-time applied between the gate drive signals for the switch and synch FETs. The algorithm constantly adjusts the deadtime non-overlap to minimize the duty cycle, thus maximizing efficiency. This algorithm will null out deadtime differences due to component variation, temperature and loading effects. The algorithm can be configured via the PMBus interface.

Over Current Protection (OCP)

The product includes current limiting circuitry for protection at continuous overload. The following OCP response options are available:

1. Initiate a shutdown and attempt to restart an infinite number of times with a preset delay period between attempts.
2. Initiate a shutdown and attempt to restart a preset number of times with a preset delay period
3. Continue operating for a given delay period, followed by shutdown if the fault still exists.
4. Continue operating through the fault (this could result in permanent damage to the product).
5. Initiate an immediate shutdown.

The default response from an over current fault is an immediate shutdown of the device. The device will continuously check for the presence of the fault condition, and if the fault condition no longer exists the device will be re-enabled. The load distribution should be designed for the maximum output short circuit current specified. The OCP limit and response of the product can be reconfigured using the PMBus interface.

Start-up Procedure

The product follows a specific internal start-up procedure after power is applied to the VIN pin:

1. Status of the address and output voltage pin-strap pins are checked and values associated with the pin settings are loaded.

BMR462 series PoL Regulators
 Input 4.5-14 V, Output up to 12 A / 60 W

1/28701-BMR 462 Rev.A November 2017
 © Flex

2. Values stored in the Flex default non-volatile memory are loaded. This overwrites any previously loaded values.
3. Values stored in the user non-volatile memory are loaded. This overwrites any previously loaded values.

Once this process is completed and the start-up time has passed (see Electrical Specification), the product is ready to be enabled using the CTRL pin. The product is also ready to accept commands via the PMBus interface, which will overwrite any values loaded during the start-up procedure.

Soft-start Power Up

The soft-start control introduces a time-delay before allowing the output voltage to rise. Once the boot-up time has passed and the output has been enabled, the device requires approximately 2 ms before its output voltage may be allowed to start its ramp-up process. If a soft-start delay period less than 2 ms has been configured the device will default to a 2 ms delay period. If a delay period greater than 2 ms is configured, the device will wait for the configured delay period prior to starting to ramp its output. After the delay period has expired, the output will begin to ramp towards its target voltage according to the configured soft-start ramp time.

The default settings for the soft-start delay period and the soft-start ramp time is 10 ms. Hence, power-up is completed within 20 ms in default configuration using remote control. Precise timing reduces the delay time variations and is by default activated. The soft-start power up of the product can be reconfigured using the PMBus interface.

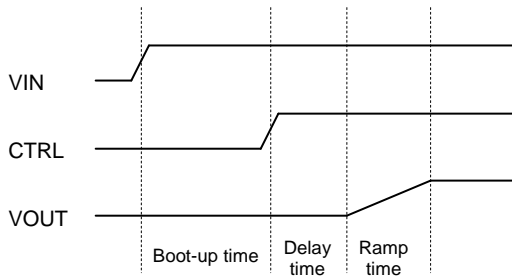

Illustration of Power Up Procedure.

Output Voltage Sequencing

A group of products may be configured to power up in a predetermined sequence. This feature is especially useful when powering advanced processors, FPGAs, and ASICs that require one supply to reach its operating voltage prior to another. Multi-product sequencing can be achieved by configuring the start delay and rise time of each device through the PMBus interface and by using the CTRL start signal. See application note AN310 for further information.

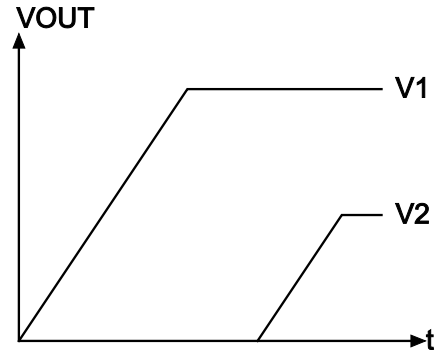

Illustration of Output Voltage Sequencing.

Voltage Tracking

The product integrates a lossless tracking scheme that allows its output to track a voltage that is applied to the VTRK pin with no external components required. During ramp-up, the output voltage follows the VTRK voltage until the preset output voltage level is met. The product offers two modes of tracking as follows:

1. Coincident. This mode configures the product to ramp its output voltage at the same rate as the voltage applied to the VTRK pin.

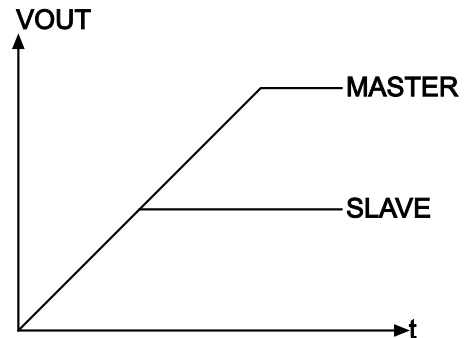

Illustration of Coincident Voltage Tracking.

2. Ratiometric. This mode configures the product to ramp its output voltage at a rate that is a percentage of the voltage applied to the VTRK pin. The default setting is 50%, but a different tracking ratio may be set by an external resistive voltage divider or through the PMBus interface.

BMR462 series PoL Regulators
Input 4.5-14 V, Output up to 12 A / 60 W

1/28701-BMR 462 Rev.A November 2017

© Flex

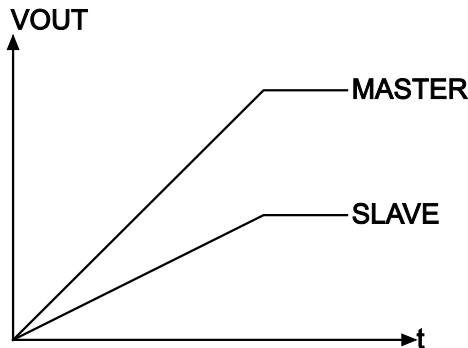

Illustration of Ratiometric Voltage Tracking

The master device in a tracking group is defined as the device that has the highest target output voltage within the group. This master device will control the ramp rate of all tracking devices and is not configured for tracking mode. All of the CTRL pins in the tracking group must be connected and driven by a single logic source. It should be noted that current sharing groups that are also configured to track another voltage do not offer pre-bias protection; a minimum load should therefore be enforced to avoid the output voltage from being held up by an outside force.

See application note AN310 for further information.

Voltage Margining Up/Down

The product can adjust its output higher or lower than its nominal voltage setting in order to determine whether the load device is capable of operating over its specified supply voltage range. This provides a convenient method for dynamically testing the operation of the load circuit over its supply margin or range. It can also be used to verify the function of supply voltage supervisors. Margin limits of the nominal output voltage $\pm 5\%$ are default, but the margin limits can be reconfigured using the PMBus interface.

Pre-Bias Startup Capability

Pre-bias startup often occurs in complex digital systems when current from another power source is fed back through a dual-supply logic component, such as FPGAs or ASICs. The product incorporates synchronous rectifiers, but will not sink current during startup, or turn off, or whenever a fault shuts down the product in a pre-bias condition. Pre-bias protection is not offered for current sharing groups that also have voltage tracking enabled.

Group Communication Bus

The Group Communication Bus, GCB, is used to communicate between products. This dedicated bus provides the communication channel between devices for features such as sequencing, fault spreading and current sharing. The GCB bus solves the PMBus data rate limitation. The GCB pin of all products in an application should be connected together. A pull-up resistor is required on the common GCB in order to guarantee the rise time as follows:

$$\text{Eq. 6} \quad \tau = R_{GCB} C_{GCB} \leq 1\mu\text{s}$$

where R_{GCB} is the pull up resistor value and C_{GCB} is the bus loading. The pull-up resistor should be tied to an external supply voltage in range from 3 to 5.5 V, which should be present prior to or during power-up.

If exploring untested compensation or deadtime configurations, it is recommended that 27 Ω series resistors are placed between the GCB pin of each product and the common GCB connection. This will avoid propagation of faults between products potentially caused by hazardous configuration settings. When the configurations of the products are settled the series resistors can be removed.

The GCB is an internal bus, such that it is only connected across the modules and not the PMBus system host. GCB addresses are assigned on a rail level, i.e. modules within the same current sharing group share the same GCB address. Addressing rails across the GCB is done with a 5 bit GCB ID, yielding a theoretical total of 32 rails that can be shared with a single GCB bus.

Fault spreading

The product can be configured to broadcast a fault event over the GCB bus to the other devices in the group. When a non-destructive fault occurs and the device is configured to shut down on a fault, the device will shut down and broadcast the fault event over the GCB bus. The other devices on the GCB bus will shut down together if configured to do so, and will attempt to re-start in their prescribed order if configured to do so. See application note AN308 for further information.

Over Temperature Protection (OTP)

The products are protected from thermal overload by an internal over temperature shutdown circuit. When T_{P1} as defined in thermal consideration section exceeds 120°C the product will shut down. The product will make continuous attempts to start up and resume normal operation automatically when the temperature has dropped $>15^\circ\text{C}$ below the over temperature threshold. The specified OTP level and hysteresis are valid for worst case operation regarding cooling conditions, input voltage and output voltage. This means the OTP level and hysteresis in many cases will be lower. The OTP level, hysteresis, and fault response of the product can be reconfigured using the PMBus interface. The fault response can be configured as follows:

1. Initiate a shutdown and attempt to restart an infinite number of times with a preset delay period between attempts (default configuration).
2. Initiate a shutdown and attempt to restart a preset number of times with a preset delay period between attempts.
3. Continue operating for a given delay period, followed by shutdown if the fault still exists.
4. Continue operating through the fault (this could result in permanent damage to the power supply).
5. Initiate an immediate shutdown.

BMR462 series PoL Regulators

Input 4.5-14 V, Output up to 12 A / 60 W

1/28701-BMR 462 Rev.A November 2017
© Flex

Optimization examples

This product is designed with a digital control circuit. The control circuit uses a configuration file which determines the functionality and performance of the product. It is possible to change the configuration file to optimize certain performance characteristics. In the table below is a schematic view on how to change different configuration parameters in order to achieve an optimization towards a wanted performance.

| | |
|---|-----------|
| ↑ | Increase |
| → | No change |
| ↓ | Decrease |

| Config. parameters | Switching frequency | Control loop bandwidth | NLR threshold | Diode emulation (DCM) | Min. pulse |
|---------------------------------|---------------------|------------------------|---------------|-----------------------|-------------------|
| Optimized performance | | | | | |
| Maximize efficiency | ↓ | → | ↑ | Enable | Disable |
| Minimize ripple ampl. | ↑ | → | ↑ | Enable or disable | Enable or disable |
| Improve load transient response | ↑ | ↑ | ↓ | Disable | Disable |
| Minimize idle power loss | ↓ | ↑ | → | Enable | Enable |

| | | | | | | |
|------------|------------------------------|---|---|------|-----|----|
| P_{ii} | Input idling power (no load) | Default configuration: Continues Conduction Mode, CCM | $V_o = 0.6 V$ | 0.36 | W | |
| | | | $V_o = 1.0 V$ | 0.35 | | |
| | | | $V_o = 3.3 V$ | 0.54 | | |
| | | | $V_o = 5.0 V$ | 0.97 | | |
| P_{ii} | Input idling power (no load) | DCM, Discontinues Conduction Mode (diode emulation) | $V_o = 0.6 V$ | 0.30 | W | |
| | | | $V_o = 1.0 V$ | 0.37 | | |
| | | | $V_o = 3.3 V$ | 0.41 | | |
| | | | $V_o = 5.0 V$ | 0.45 | | |
| P_{ii} | Input idling power (no load) | DCM with Adaptive Frequency and Minimum Pulse Enabled | $V_o = 0.6 V$ | 0.29 | W | |
| | | | $V_o = 1.0 V$ | 0.35 | | |
| | | | $V_o = 3.3 V$ | 0.37 | | |
| | | | $V_o = 5.0 V$ | 0.42 | | |
| P_{CTRL} | Input standby power | Turned off with CTRL-pin | Default configuration: Monitoring enabled, Precise timing enabled | | 180 | mW |
| | | | Monitoring enabled, Precise timing | | 120 | mW |

| | | | | | |
|---------------|---|---|--|-----|----|
| V_{trt} | Load transient peak voltage deviation | Default configuration di/dt = 2 A/μs C _o =470 μF | disabled | | |
| | | | Low power mode: Monitoring disabled, Precise timing disabled | 85 | mW |
| | | | $V_o = 0.6 V$ | 55 | mV |
| | | | $V_o = 1.0 V$ | 65 | |
| $V_o = 3.3 V$ | 110 | | | | |
| V_{trt} | Load step 25-75-25% of max I _o | Optimized PID and NLR configuration di/dt = 2 A/μs C _o =470 μF | $V_o = 0.6 V$ | 40 | mV |
| | | | $V_o = 1.0 V$ | 35 | |
| | | | $V_o = 3.3 V$ | 55 | |
| | | | $V_o = 5.0 V$ | 105 | |
| t_{trt} | Load transient recovery time | Default configuration di/dt = 2 A/μs C _o =470 μF | $V_o = 0.6 V$ | 230 | us |
| | | | $V_o = 1.0 V$ | 210 | |
| | | | $V_o = 3.3 V$ | 200 | |
| | | | $V_o = 5.0 V$ | 200 | |
| | Load step 25-75-25% of max I _o | Optimized PID and NLR configuration di/dt = 2 A/μs C _o =470 μF | $V_o = 0.6 V$ | 45 | |
| | | | $V_o = 1.0 V$ | 40 | |
| | | | $V_o = 3.3 V$ | 40 | |
| | | | $V_o = 5.0 V$ | 35 | |

Efficiency vs. Output Current and Switching frequency

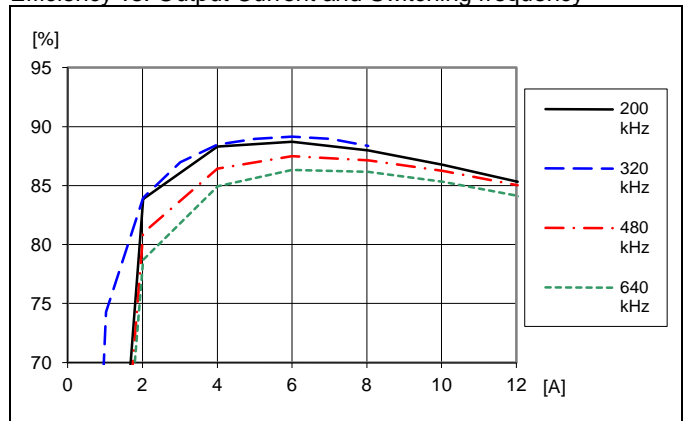

Efficiency vs. load current and switching frequency at T_{P1} = +25°C. V_I=12 V, V_O=3.3V, C_O=470 μF/10 mΩ
Default configuration except changed frequency

BMR462 series PoL Regulators Input 4.5-14 V, Output up to 12 A / 60 W

1/28701-BMR 462 Rev.A November 2017
© Flex

Power Dissipation vs. Output Current and Switching frequency

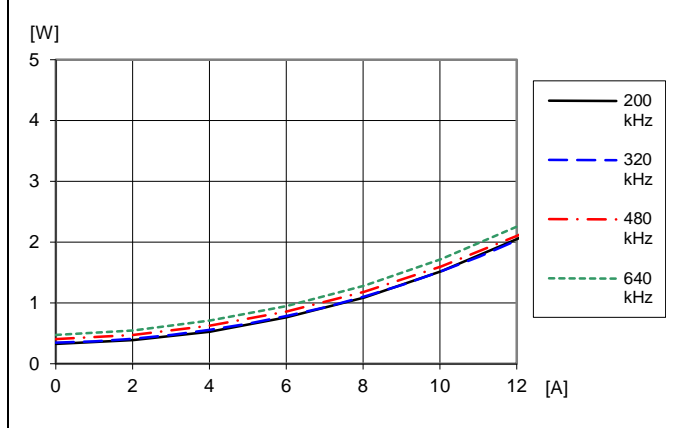

Dissipated power vs. load current and switching frequency at $T_{P1} = +25^{\circ}\text{C}$. $V_I = 12\text{ V}$, $V_O = 3.3\text{ V}$, $C_O = 470\ \mu\text{F}/10\ \text{m}\Omega$. Default configuration except changed frequency

Load Transient vs. Decoupling Capacitance, $V_O = 1.0\text{ V}$

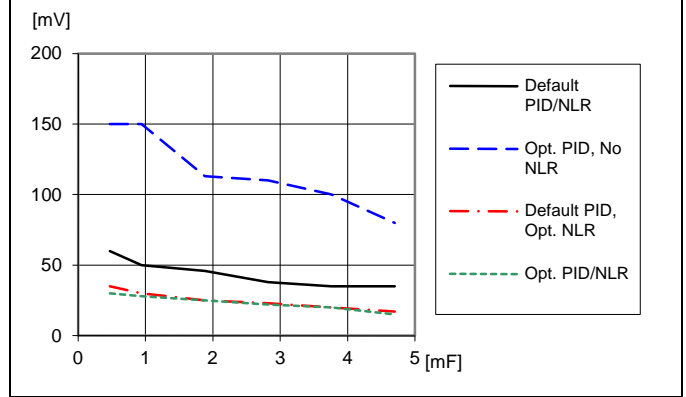

Load transient peak voltage deviation vs. decoupling capacitance. Step-change (3-9-3 A). Parallel coupling of capacitors with $470\ \mu\text{F}/10\ \text{m}\Omega$. $T_{P1} = +25^{\circ}\text{C}$. $V_I = 12\text{ V}$, $V_O = 1.0\text{ V}$, $f_{sw} = 320\ \text{kHz}$, $di/dt = 2\ \text{A}/\mu\text{s}$

Output Ripple vs. Switching frequency

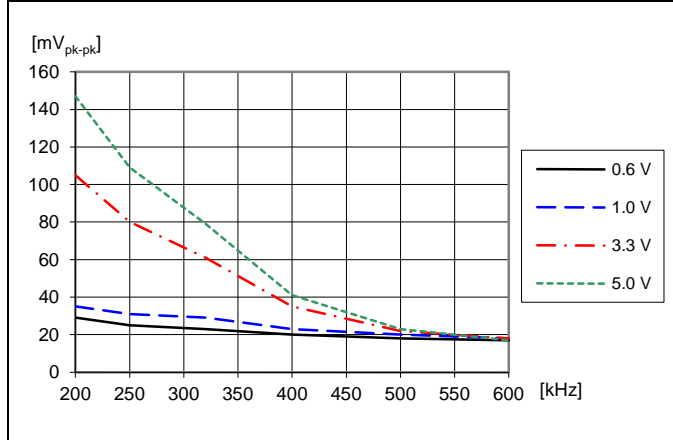

Output voltage ripple V_{pk-pk} at: $T_{P1} = +25^{\circ}\text{C}$, $V_I = 12\text{ V}$, $C_O = 470\ \mu\text{F}/10\ \text{m}\Omega$, $I_O = 12\text{ A}$ resistive load. Default configuration except changed frequency.

Load Transient vs. Decoupling Capacitance, $V_O = 3.3\text{ V}$

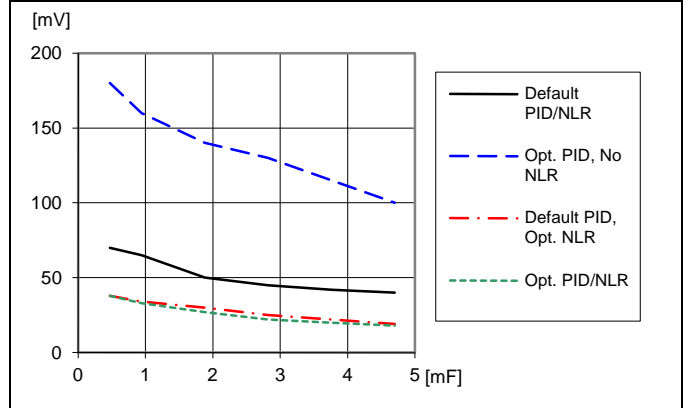

Load transient peak voltage deviation vs. decoupling capacitance. Step-change (3-9-3 A). Parallel coupling of capacitors with $470\ \mu\text{F}/10\ \text{m}\Omega$. $T_{P1} = +25^{\circ}\text{C}$. $V_I = 12\text{ V}$, $V_O = 3.3\text{ V}$, $f_{sw} = 320\ \text{kHz}$, $di/dt = 2\ \text{A}/\mu\text{s}$

Load transient vs. Switching frequency

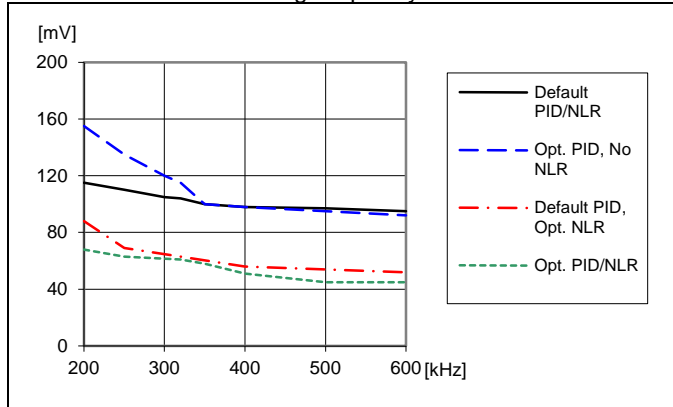

Load transient peak voltage deviation vs. frequency. Step-change (3-9-3 A). $T_{P1} = +25^{\circ}\text{C}$. $V_I = 12\text{ V}$, $V_O = 3.3\text{ V}$, $C_O = 470\ \mu\text{F}/10\ \text{m}\Omega$

Output Load Transient Response, Default PID/NLR

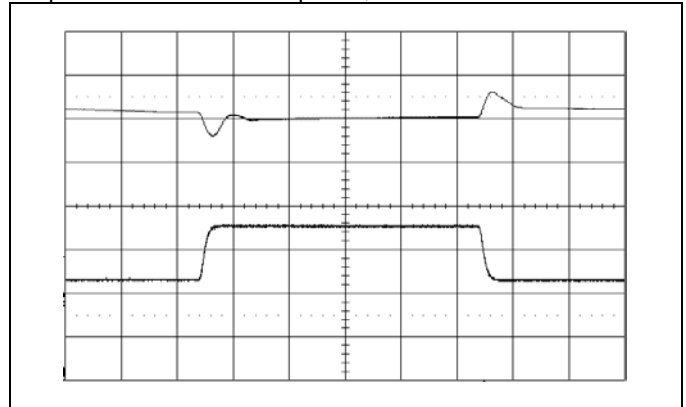

Output voltage response to load current step-change (3-9-3 A) at: $T_{P1} = +25^{\circ}\text{C}$, $V_I = 12\text{ V}$, $V_O = 3.3\text{ V}$, $di/dt = 2\ \text{A}/\mu\text{s}$, $f_{sw} = 320\ \text{kHz}$, $C_O = 470\ \mu\text{F}/10\ \text{m}\Omega$. Default PID Control Loop and NLR. Top trace: output voltage (200 mV/div.). Bottom trace: load current (5 A/div.). Time scale: (0.1 ms/div.).

BMR462 series PoL Regulators
 Input 4.5-14 V, Output up to 12 A / 60 W

1/28701-BMR 462 Rev.A November 2017
 © Flex

Output Load Transient Response, Optimized PID, no NLR

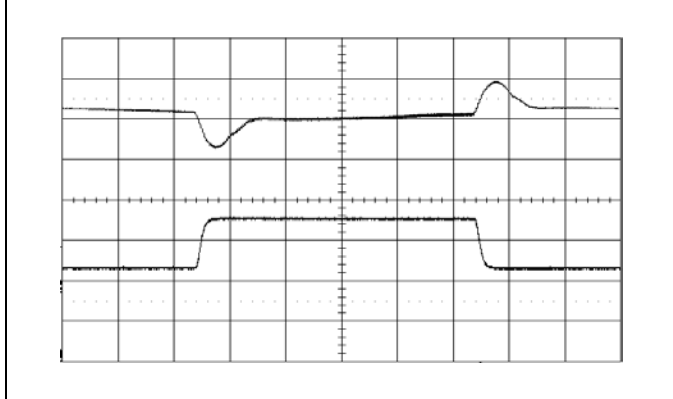

Output voltage response to load current step-change (3-9-3 A) at:
 $T_{P1} = +25^{\circ}\text{C}$, $V_I = 12\text{ V}$, $V_O = 3.3\text{ V}$
 $di/dt = 2\text{ A}/\mu\text{s}$, $f_{sw} = 320\text{ kHz}$, $C_O = 470\text{ }\mu\text{F}/10\text{ m}\Omega$
 Optimized PID Control Loop and no NLR
 Top trace: output voltage (200 mV/div.).
 Bottom trace: load current (5 A/div.).
 Time scale: (0.1 ms/div.).

Output Load Transient Response, Optimized NLR

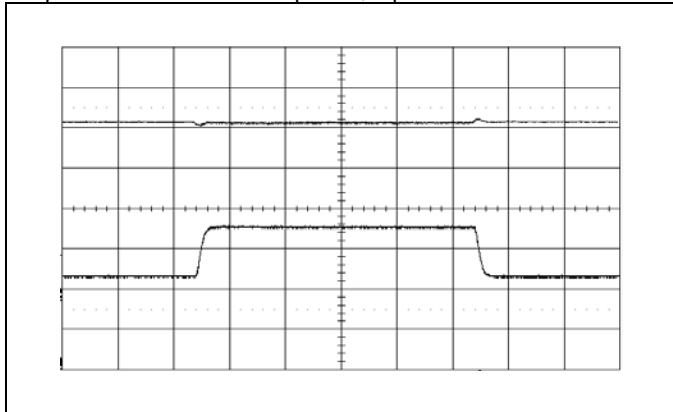

Output voltage response to load current step-change (3-9-3 A) at:
 $T_{P1} = +25^{\circ}\text{C}$, $V_I = 12\text{ V}$, $V_O = 3.3\text{ V}$
 $di/dt = 2\text{ A}/\mu\text{s}$, $f_{sw} = 320\text{ kHz}$, $C_O = 470\text{ }\mu\text{F}/10\text{ m}\Omega$
 Default PID Control Loop and optimized NLR
 Top trace: output voltage (200 mV/div.).
 Bottom trace: load current (5 A/div.).
 Time scale: (0.1 ms/div.).

Thermal Consideration

General

The product is designed to operate in different thermal environments and sufficient cooling must be provided to ensure reliable operation. Cooling is achieved mainly by conduction, from the pins to the host board, and convection, which is dependant on the airflow across the product. Increased airflow enhances the cooling of the product. The Output Current Derating graph found in the Output section for each model provides the available output current vs. ambient air temperature and air velocity at specified V_I .

The product is tested on a 254 x 254 mm, 35 μm (1 oz), test board mounted vertically in a wind tunnel with a cross-section of 608 x 203 mm. The test board has 8 layers.

Proper cooling of the product can be verified by measuring the

temperature at positions P1 and P2. The temperature at these positions should not exceed the max values provided in the table below. Note that the max value is the absolute maximum rating (non destruction) and that the electrical Output data is guaranteed up to $T_{P1} + 95^{\circ}\text{C}$.

See Design Note 019 for further information.

Definition of product operating temperature

The product operating temperatures are used to monitor the temperature of the product, and proper thermal conditions can be verified by measuring the temperature at positions P1 and P2. The temperature at these positions (T_{P1} , T_{P2}) should not exceed the maximum temperatures in the table below. The number of measurement points may vary with different thermal design and topology. Temperatures above maximum T_{P1} , measured at the reference point P1 are not allowed and may cause permanent damage.

| Position | Description | Max Temp. |
|----------|-------------------------------|-----------|
| P1 | Reference point, L1, inductor | 120°C |
| P2 | N1, control circuit | 120°C |

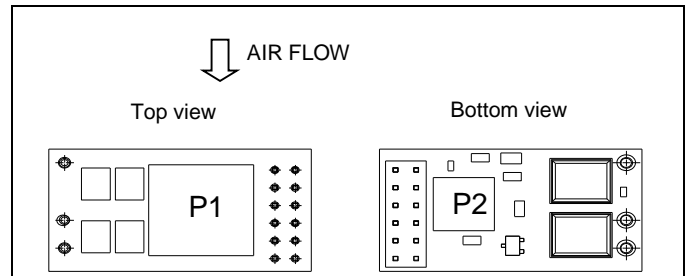

Temperature positions and air flow direction.

SIP version

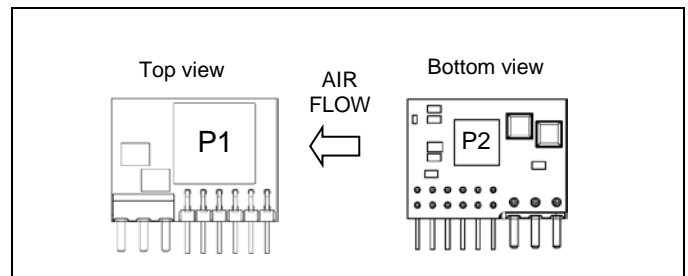

Temperature positions and air flow direction.

Definition of reference temperature T_{P1}

The reference temperature is used to monitor the temperature limits of the product. Temperature above maximum T_{P1} , measured at the reference point P1 is not allowed and may cause degradation or permanent damage to the product. T_{P1} is also used to define the temperature range for normal operating

BMR462 series PoL Regulators
 Input 4.5-14 V, Output up to 12 A / 60 W

1/28701-BMR 462 Rev.A November 2017
 © Flex

also used to define the temperature range for normal operating conditions. T_{P1} is defined by the design and used to guarantee safety margins, proper operation and high reliability of the product.

Connections (Lay Down version)

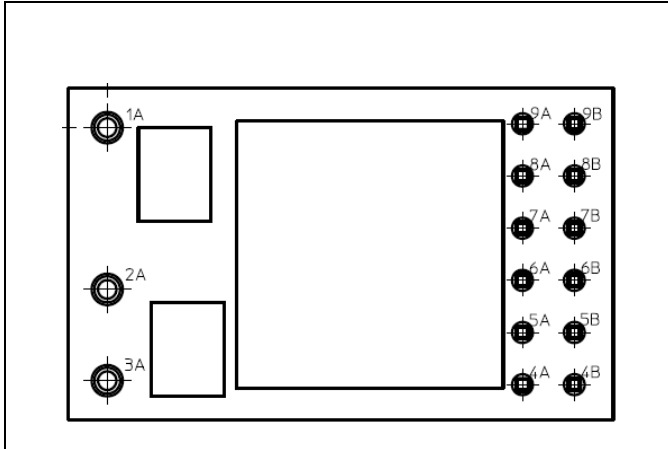

Pin layout, top view (component placement for illustration only).

Connections (SIP version)

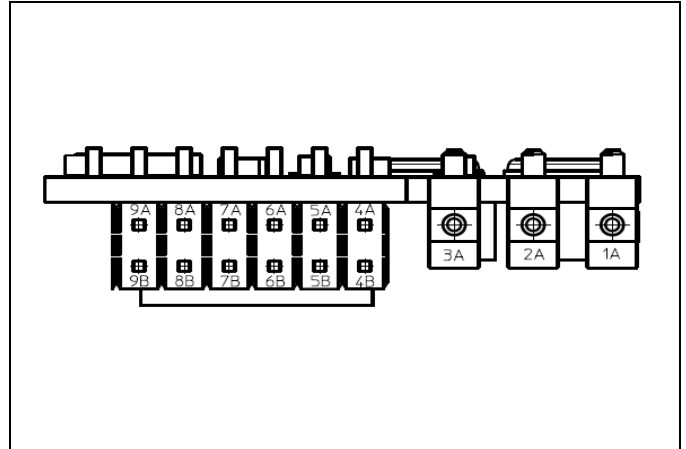

Pin layout, bottom view (component placement for illustration only).

| Pin | Designation | Function |
|-----|--------------|--------------------------------------|
| 1A | VIN | Input Voltage |
| 2A | GND | Power Ground |
| 3A | VOUT | Output Voltage |
| 4A | VTRK or PG * | Voltage Tracking input or Power Good |
| 4B | PREF | Pin-strap reference |
| 5A | +S | Positive sense |
| 5B | -S | Negative sense |
| 6A | SA0 | PMBus address pinstrap |
| 6B | GCB | Group Communication Bus |
| 7A | SCL | PMBus Clock |
| 7B | SDA | PMBus Data |
| 8A | VSET | Output voltage pinstrap |
| 8B | SYNC | Synchronization I/O |
| 9A | SALERT | PMBus Alert |
| 9B | CTRL | Remote Control |

| Pin | Designation | Function |
|-----|-------------|--------------------------|
| 1A | VIN | Input Voltage |
| 2A | GND | Power Ground |
| 3A | VOUT | Output voltage |
| 4A | +S | Positive sense |
| 4B | -S | Negative sense |
| 5A | VSET | Output voltage pin-strap |
| 5B | VTRK | Voltage tracking input |
| 6A | SALERT | PMBus Alert |
| 6B | SDA | PMBus data |
| 7A | SCL | PMBus Clock |
| 7B | SYNC | Synchronization I/O |
| 8A | SA0 | PMBus address pin-strap |
| 8B | CTRL | Remote Control |
| 9A | GCB | Group Communication Bus |
| 9B | PREF | Pin-strap Reference |

*

BMR 462 0002, BMR 462 1002: Pin 4A = VTRK pin.

BMR 462 0006, BMR 462 1006: Pin 4A = PG pin.

For these products the PG pin is internally tied to the VTRK input of the products' controller. Typically the VTRK input bias current will be equivalent to a 50 kohm pull-down resistor. This should be considered when choosing pull-up resistor for the PG signal.

BMR462 series PoL Regulators
Input 4.5-14 V, Output up to 12 A / 60 W

1/28701-BMR 462 Rev.A November 2017

© Flex

Unused input pins

Unused SDA, SCL and GCB pins should still have pull-up resistors as specified.

Unused VTRK or SYNC pins should be left unconnected or connected to the PREF pin.

Unused CTRL pin can be left open due to internal pull-up. VSET and SA0/SA1 pins must have pinstrap resistors as specified.

PWB layout considerations

The pinstrap resistors, R_{SET} , and R_{SA0}/R_{SA1} should be placed as close to the product as possible to minimize loops that may pick up noise.

Avoid current carrying planes under the pinstrap resistors and the PMBus signals.

The capacitor C_1 (or capacitors implementing it) should be placed as close to the input pins as possible. See AN323 for more details.

Capacitor C_O (or capacitors implementing it) should be placed close to the load. See AN321 for more details.

Care should be taken in the routing of the connections from the sensed output voltage to the S+ and S- terminals. These sensing connections should be routed as a differential pair, preferably between ground planes which are not carrying high currents. The routing should avoid areas of high electric or magnetic fields.

BMR462 series PoL Regulators
 Input 4.5-14 V, Output up to 12 A / 60 W

1/28701-BMR 462 Rev.A November 2017
 © Flex

Typical Application Circuit

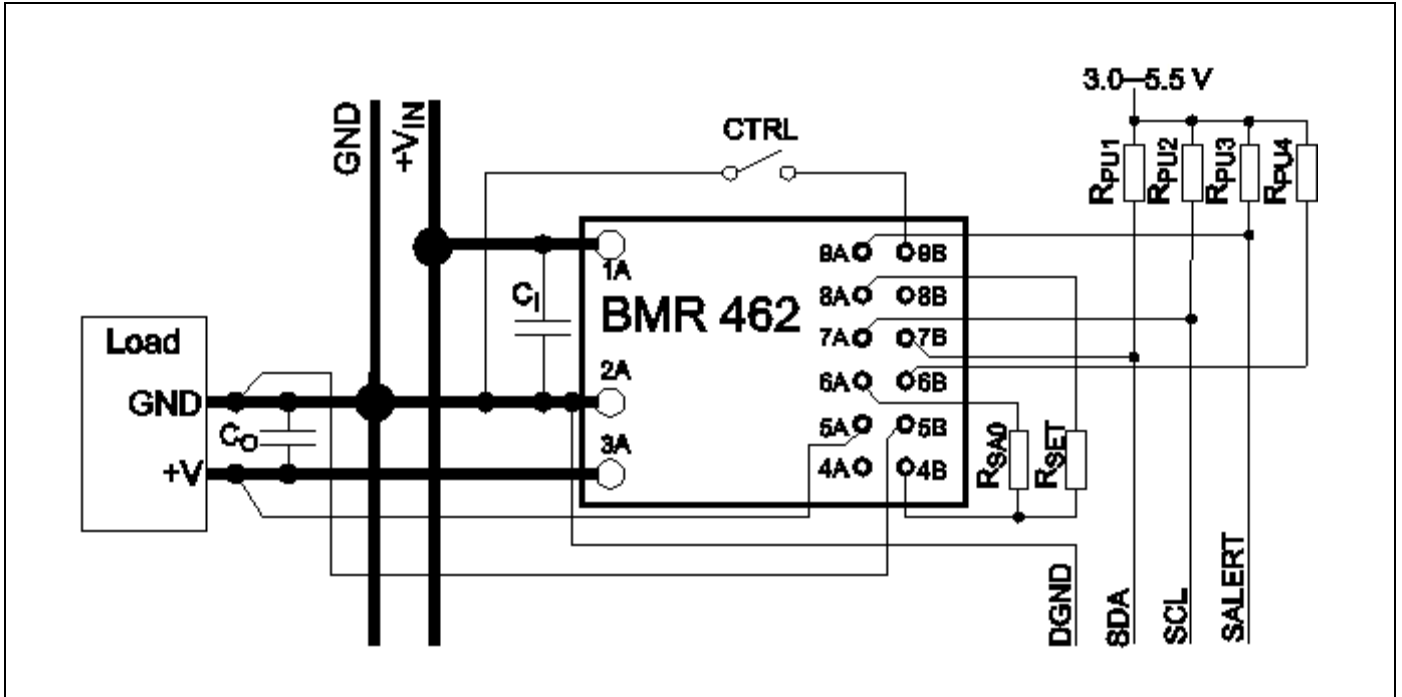

Standalone operation with PMBus communication. Top view of product footprint.

BMR462 series PoL Regulators
 Input 4.5-14 V, Output up to 12 A / 60 W

1/28701-BMR 462 Rev.A November 2017
 © Flex

Typical Application Circuit (SIP version)

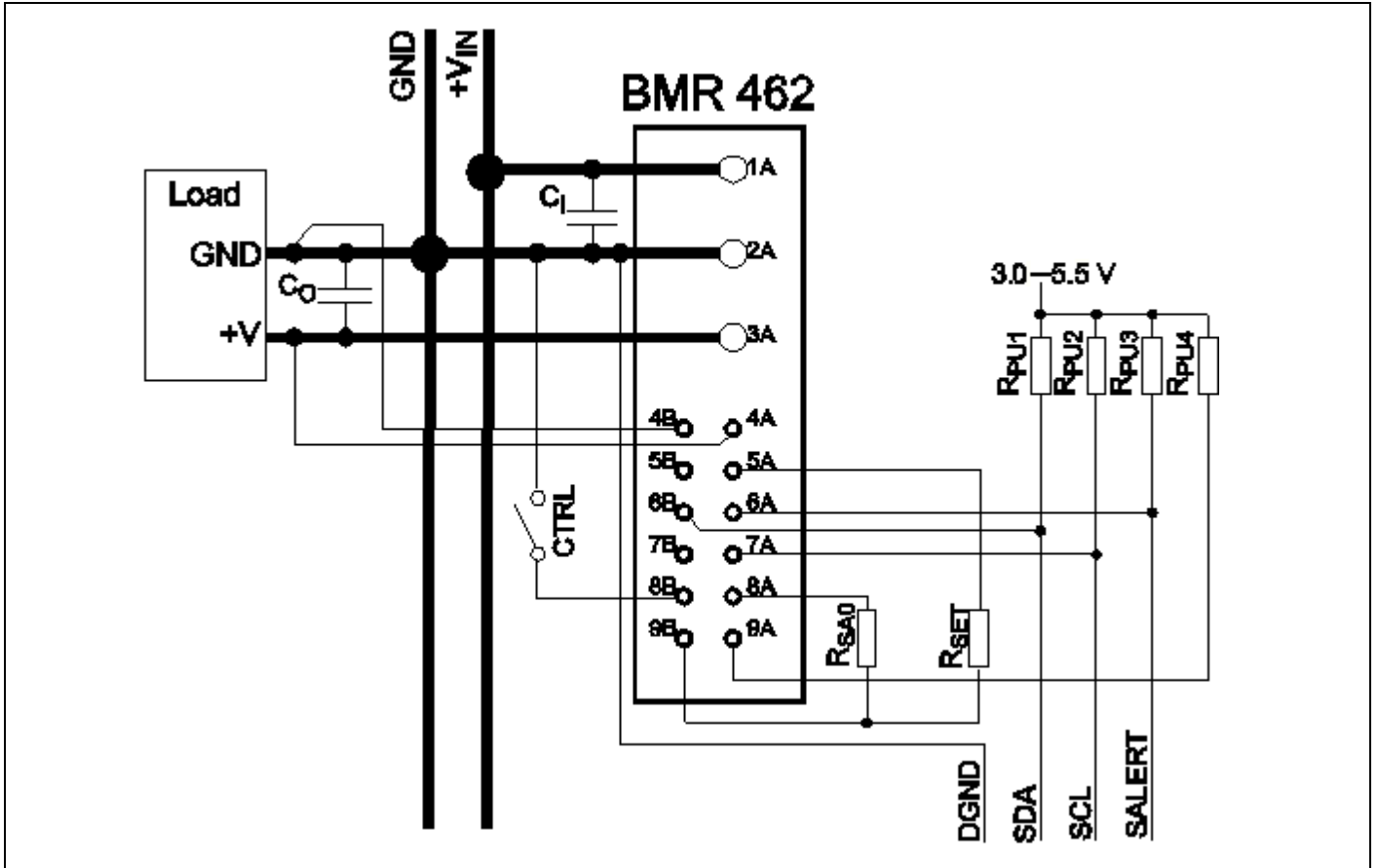

Standalone operation with PMBus communication. Top view of product footprint.

| | |
|---|--|
| BMR462 series PoL Regulators Input 4.5-14 V, Output up to 12 A / 60 W | 1/28701-BMR 462 Rev.A November 2017 |
| | © Flex |

PMBus interface

This product provides a PMBus digital interface that enables the user to configure many aspects of the device operation as well as to monitor the input and output voltages, output current and device temperature. The product can be used with any standard two-wire I²C or SMBus host device. In addition, the product is compatible with PMBus version 1.3 and includes an SALERT line to help mitigate bandwidth limitations related to continuous fault monitoring. The product supports 10k-100kHz bus clock frequency only. The PMBus signals, SCL, SDA and SALERT require passive pull-up resistors as stated in the SMBus Specification. Pull-up resistors are required to guarantee the rise time as follows:

$$\text{Eq. 7} \quad \tau = R_p C_p \leq 1\mu\text{s}$$

where R_p is the pull-up resistor value and C_p is the bus loading, the maximum allowed bus load is 400 pF. The pull-up resistor should be tied to an external supply voltage in range from 3 to 5.5 V, which should be present prior to or during power-up. If the proper power supply is not available, voltage dividers may be applied. Note that in this case, the resistance in the equation above corresponds to parallel connection of the resistors forming the voltage divider.

See application note AN304 for details on interfacing the product with a microcontroller.

Monitoring via PMBus

It is possible to monitor a wide variety of parameters through the PMBus interface. Fault conditions can be monitored using the SALERT pin, which will be asserted when any number of pre-configured fault or warning conditions occur. It is also possible to continuously monitor one or more of the power conversion parameters including but not limited to the following:

- Input voltage
- Output voltage
- Output current
- Internal junction temperature
- Switching frequency
- Duty cycle

In the default configuration monitoring is enabled also when the output voltage is disabled. This can be changed in order to reduce standby power consumption.

Snap shot parameter capture

This product offers a special feature that enables the user to capture parametric data during normal operation or following a fault. The following parameters are stored:

- Input voltage
- Output voltage
- Output current
- Internal junction temperature
- Switching frequency
- Duty cycle
- Status registers

The Snapshot feature enables the user to read the parameters via the PMBus interface during normal operation, although it should be noted that reading the 22 bytes will occupy the bus for some time. The Snapshot enables the user to store the snapshot parameters to Flash memory in response to a pending fault as well as to read the stored data from Flash memory after a fault has occurred. Automatic store to Flash memory following a fault is triggered when any fault threshold level is exceeded, provided that the specific fault response is to shut down. Writing to Flash memory is not allowed if the device is configured to restart following the specific fault condition. It should also be noted that the device supply voltage must be maintained during the time the device is writing data to Flash memory; a process that requires between 700-1400 μs depending on whether the data is set up for a block write. Undesirable results may be observed if the input voltage of the product drops below 3.0 V during this process.

Software tools for design and production

Flex provides software tools for configuration and monitoring of this product via the PMBus interface.

For more information please contact your local Flex sales representative.

BMR462 series PoL Regulators
 Input 4.5-14 V, Output up to 12 A / 60 W

1/28701-BMR 462 Rev.A November 2017
 © Flex

PMBus addressing

The PMBus address should be configured with resistors connected between the SA0/SA1 pins and the PREF pin, as shown in the figure below. Recommended resistor values for hard-wiring PMBus addresses are shown in the table. 1% tolerance resistors are required.

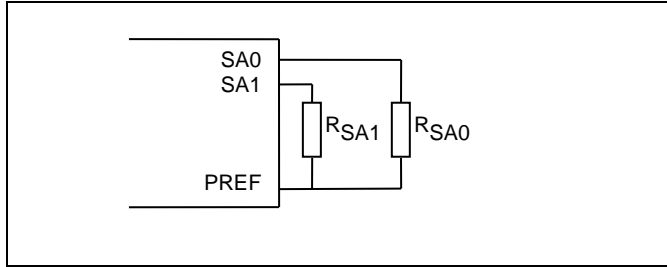

Schematic of connection of address resistor.

| Index | R _{SA} [kΩ] | Index | R _{SA} [kΩ] |
|-------|----------------------|-------|----------------------|
| 0 | 10 | 13 | 34.8 |
| 1 | 11 | 14 | 38.3 |
| 2 | 12.1 | 15 | 42.2 |
| 3 | 13.3 | 16 | 46.4 |
| 4 | 14.7 | 17 | 51.1 |
| 5 | 16.2 | 18 | 56.2 |
| 6 | 17.8 | 19 | 61.9 |
| 7 | 19.6 | 20 | 68.1 |
| 8 | 21.5 | 21 | 75 |
| 9 | 23.7 | 22 | 82.5 |
| 10 | 26.1 | 23 | 90.9 |
| 11 | 28.7 | 24 | 100 |
| 12 | 31.6 | | |

The PMBus address follows the equation below:

Eq. 8 PMBus Address (decimal) = 25 x (SA1 index) + (SA0 index)

The user can theoretically configure up to 625 unique PMBus addresses, however the PMBus address range is inherently limited to 128. Therefore, the user should use index values 0 - 4 on the SA1 pin and the full range of index values on the SA0 pin, which will provide 125 device address combinations.

Products with no SA1 pin have an internally defined SA1 index as follows.

| Product | SA1 index |
|---------|-----------|
| BMR 462 | 4 |

Optional PMBus Addressing

Alternatively the PMBus address can be defined by connecting the SA0/SA1 pins according to the table below. SA1 = open for products with no SA1 pin.

| | | SA0 | | |
|-----|------|-----|------|----------|
| | | low | open | high |
| SA1 | low | 20h | 21h | 22h |
| | open | 23h | 24h | 25h |
| | high | 26h | 27h | Reserved |

Low = Shorted to PREF
 Open = High impedance
 High = Logic high, GND as reference,
 Logic High definitions see Electrical Specification

Reserved Addresses

Address 4Bh is allocated for production needs and can not be used.

Addresses listed in the table below are reserved or assigned according to the SMBus specification and may not be usable. Refer to the SMBus specification for further information.

| Address (decimal) | Comment |
|-------------------|--|
| 0 | General Call Address / START byte |
| 1 | CBUS address |
| 2 | Address reserved for different bus format |
| 3-7 | Reserved for future use |
| 8 | SMBus Host |
| 9-11 | Assigned for Smart Battery |
| 12 | SMBus Alert Response Address |
| 40 | Reserved for ACCESS.bus host |
| 44-45 | Reserved by previous versions of the SMBus specification |
| 55 | Reserved for ACCESS.bus default address |
| 64-68 | Reserved by previous versions of the SMBus specification |
| 72-75 | Unrestricted addresses |
| 97 | SMBus Device Default Address |
| 120-123 | 10-bit slave addressing |
| 124-127 | Reserved for future use |

BMR462 series PoL Regulators
Input 4.5-14 V, Output up to 12 A / 60 W

1/28701-BMR 462 Rev.A November 2017

© Flex

I²C/SMBus – Timing

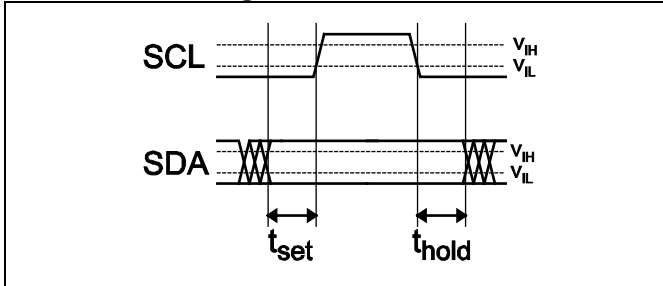

Setup and hold times timing diagram

The setup time, t_{set} , is the time data, SDA, must be stable before the rising edge of the clock signal, SCL. The hold time t_{hold} , is the time data, SDA, must be stable after the falling edge of the clock signal, SCL. If these times are violated incorrect data may be captured or meta-stability may occur and the bus communication may fail. When configuring the product, all standard SMBus protocols must be followed, including clock stretching. Refer to the SMBus specification, for SMBus electrical and timing requirements.

This product does not support the BUSY flag in the status commands to indicate product being too busy for SMBus response. Instead a bus-free time delay according to this specification must occur between every SMBus transmission (between every stop & start condition). In case of storing the RAM content into the internal non-volatile memory an additional delay of 100 ms has to be inserted.

BMR462 series PoL Regulators
Input 4.5-14 V, Output up to 12 A / 60 W

1/28701-BMR 462 Rev.A November 2017

© Flex

PMBus Commands

The products are PMBus compliant. The following table lists the implemented PMBus read commands. For more detailed information see PMBus Power System Management Protocol Specification; Part I – General Requirements, Transport and Electrical Interface and PMBus Power System Management Protocol; Part II – Command Language.

| Designation | Cmd | Impl |
|--------------------------------|-----|------|
| Standard PMBus Commands | | |
| Control Commands | | |
| PAGE | 00h | No |
| OPERATION | 01h | Yes |
| ON_OFF_CONFIG | 02h | Yes |
| WRITE_PROTECT | 10h | No |
| Output Commands | | |
| VOUT_MODE (Read Only) | 20h | Yes |
| VOUT_COMMAND | 21h | Yes |
| VOUT_TRIM | 22h | Yes |
| VOUT_CAL_OFFSET | 23h | Yes |
| VOUT_MAX | 24h | Yes |
| VOUT_MARGIN_HIGH | 25h | Yes |
| VOUT_MARGIN_LOW | 26h | Yes |
| VOUT_TRANSITION_RATE | 27h | Yes |
| VOUT_DROOP | 28h | Yes |
| MAX_DUTY | 32h | Yes |
| FREQUENCY_SWITCH | 33h | Yes |
| VIN_ON | 35h | No |
| VIN_OFF | 36h | No |
| IOUT_CAL_GAIN | 38h | Yes |
| IOUT_CAL_OFFSET | 39h | Yes |
| VOUT_SCALE_LOOP | 29h | No |
| VOUT_SCALE_MONITOR | 2Ah | No |
| COEFFICIENTS | 30h | No |
| Fault Limit Commands | | |
| POWER_GOOD_ON | 5Eh | Yes |
| POWER_GOOD_OFF | 5Fh | No |
| VOUT_OV_FAULT_LIMIT | 40h | Yes |
| VOUT_OV_WARN_LIMIT | 42h | No |
| VOUT_UV_WARN_LIMIT | 43h | No |
| VOUT_UV_FAULT_LIMIT | 44h | Yes |
| IOUT_OC_FAULT_LIMIT | 46h | Yes |
| IOUT_OC_WARN_LIMIT | 4Ah | No |
| IOUT_UC_FAULT_LIMIT | 4Bh | Yes |

| Designation | Cmd | Impl |
|-------------------------------------|-----|------|
| OT_FAULT_LIMIT | 4Fh | Yes |
| OT_WARN_LIMIT | 51h | Yes |
| UT_WARN_LIMIT | 52h | Yes |
| UT_FAULT_LIMIT | 53h | Yes |
| VIN_OV_FAULT_LIMIT | 55h | Yes |
| VIN_OV_WARN_LIMIT | 57h | Yes |
| VIN_UV_WARN_LIMIT | 58h | Yes |
| VIN_UV_FAULT_LIMIT | 59h | Yes |
| Fault Response Commands | | |
| VOUT_OV_FAULT_RESPONSE | 41h | Yes |
| VOUT_UV_FAULT_RESPONSE | 45h | Yes |
| OT_FAULT_RESPONSE | 50h | Yes |
| UT_FAULT_RESPONSE | 54h | Yes |
| VIN_OV_FAULT_RESPONSE | 56h | Yes |
| VIN_UV_FAULT_RESPONSE | 5Ah | Yes |
| IOUT_OC_FAULT_RESPONSE | 47h | No |
| IOUT_UC_FAULT_RESPONSE | 4Ch | No |
| Time setting Commands | | |
| TON_DELAY | 60h | Yes |
| TON_RISE | 61h | Yes |
| TOFF_DELAY | 64h | Yes |
| TOFF_FALL | 65h | Yes |
| TON_MAX_FAULT_LIMIT | 62h | No |
| Status Commands (Read Only) | | |
| CLEAR_FAULTS | 03h | Yes |
| STATUS_BYTE | 78h | Yes |
| STATUS_WORD | 79h | Yes |
| STATUS_VOUT | 7Ah | Yes |
| STATUS_IOUT | 7Bh | Yes |
| STATUS_INPUT | 7Ch | Yes |
| STATUS_TEMPERATURE | 7Dh | Yes |
| STATUS_CML | 7Eh | Yes |
| STATUS_MFR_SPECIFIC | 80h | Yes |
| Monitor Commands (Read Only) | | |
| READ_VIN | 88h | Yes |
| READ_VOUT | 8Bh | Yes |
| READ_IOUT | 8Ch | Yes |
| READ_TEMPERATURE_1 | 8Dh | Yes |
| READ_TEMPERATURE_2 | 8Eh | No |
| READ_FAN_SPEED_1 | 90h | No |
| READ_DUTY_CYCLE | 94h | Yes |
| READ_FREQUENCY | 95h | Yes |

BMR462 series PoL Regulators
 Input 4.5-14 V, Output up to 12 A / 60 W

1/28701-BMR 462 Rev.A November 2017

© Flex

| Designation | Cmd | Impl |
|---|-----|------|
| Group Commands | | |
| INTERLEAVE | 37h | Yes |
| PHASE_CONTROL | F0h | Yes |
| Identification Commands | | |
| PMBUS_REVISION | 98h | Yes |
| MFR_ID | 99h | Yes |
| MFR_MODEL | 9Ah | Yes |
| MFR_REVISION | 9Bh | Yes |
| MFR_LOCATION | 9Ch | Yes |
| MFR_DATE | 9Dh | Yes |
| MFR_SERIAL | 9Eh | Yes |
| Supervisory Commands | | |
| STORE_DEFAULT_ALL | 11h | Yes |
| RESTORE_DEFAULT_ALL | 12h | Yes |
| STORE_USER_ALL | 15h | Yes |
| RESTORE_USER_ALL | 16h | Yes |
| Product Specific Commands | | |
| Time Setting Commands | | |
| POWER_GOOD_DELAY | D4h | Yes |
| Fault limit Commands | | |
| IOUT_AVG_OC_FAULT_LIMIT | E7h | Yes |
| IOUT_AVG_UC_FAULT_LIMIT | E8h | Yes |
| Fault Response Commands | | |
| MFR_IOUT_OC_FAULT_RESPONSE | E5h | Yes |
| MFR_IOUT_UC_FAULT_RESPONSE | E6h | Yes |
| OVUV_CONFIG | D8h | Yes |
| Configuration and Control Commands | | |
| MFR_CONFIG | D0h | Yes |
| USER_CONFIG | D1h | Yes |
| MISC_CONFIG | E9h | Yes |
| TRACK_CONFIG | E1h | Yes |
| PID_TAPS | D5h | Yes |
| PID_TAPS_CALC | F2h | Yes |
| INDUCTOR | D6h | Yes |
| NLR_CONFIG | D7h | Yes |
| TEMPCO_CONFIG | DCh | Yes |
| IOUT_OMEGA_OFFSET | BEh | Yes |
| DEADTIME | DDh | Yes |
| DEADTIME_CONFIG | DEh | Yes |
| DEADTIME_MAX | BFh | Yes |
| SNAPSHOT | EAh | Yes |

| Designation | Cmd | Impl |
|-----------------------------|-----|------|
| SNAPSHOT_CONTROL | F3h | Yes |
| DEVICE_ID | E4h | Yes |
| USER_DATA_00 | B0h | Yes |
| Group Commands | | |
| SEQUENCE | E0h | Yes |
| GCB_CONFIG | D3h | Yes |
| GCB_GROUP | E2h | Yes |
| ISHARE_CONFIG | D2h | Yes |
| PHASE_CONTROL | F0h | Yes |
| Supervisory Commands | | |
| PRIVATE_PASSWORD | FBh | Yes |
| PUBLIC_PASSWORD | FCh | Yes |
| UNPROTECT | FDh | Yes |
| SECURITY_LEVEL | FAh | Yes |

Notes:

Cmd is short for Command.

Impl is short for Implemented.

BMR462 series PoL Regulators
 Input 4.5-14 V, Output up to 12 A / 60 W

1/28701-BMR 462 Rev.A November 2017
 © Flex

Mechanical Information - Hole Mount, Lay Down Version

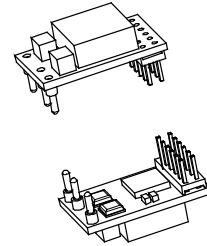
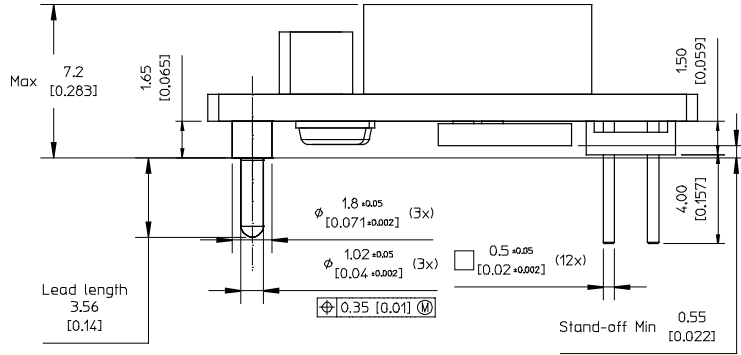

TOP VIEW
 Pin positions according to recommended footprint

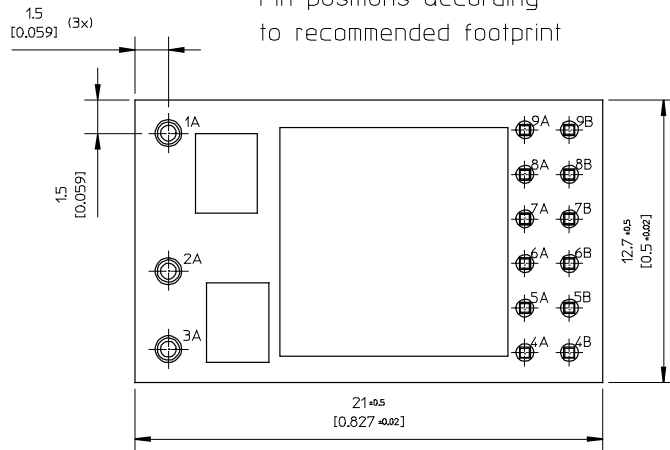

PIN SPECIFICATIONS
 Pin 1A-3A Material: Copper alloy
 Plating: Min Matte tin 8-13 μm over 2.5-5 μm Ni.
 Pin 4A-9B Material: Brass
 Plating: Min Au 0.2 μm over 1.27 μm Ni.

RECOMMENDED FOOTPRINT - TOP VIEW

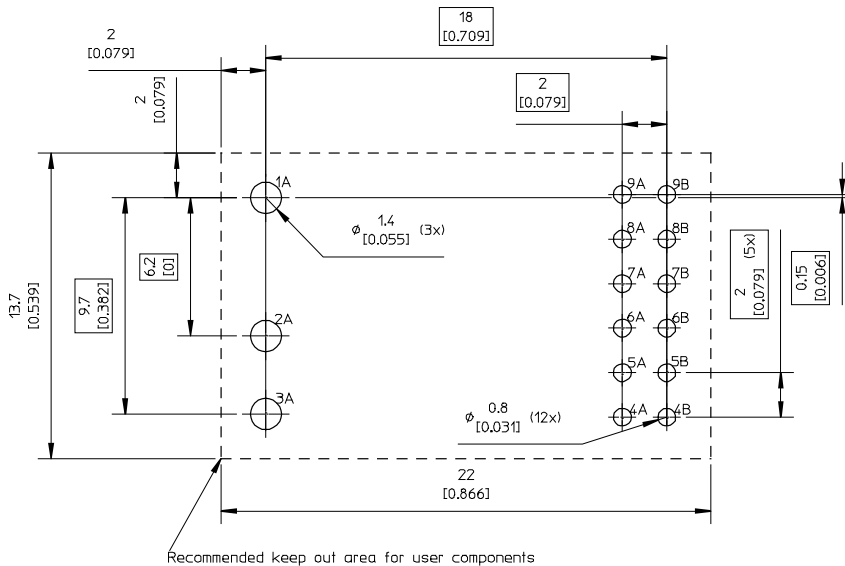

Weight: Typical 4.5 g
 All dimensions in mm [inch]
 Tolerances unless specified:
 x.x ±0.5 mm [0.02]
 x.xx±0.25 mm [0.01]
 (not applied on footprint or typical values)



BMR462 series PoL Regulators
 Input 4.5-14 V, Output up to 12 A / 60 W

1/28701-BMR 462 Rev.A November 2017

© Flex

Mechanical Information - Surface Mount, Lay Down Version

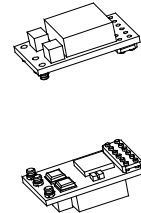
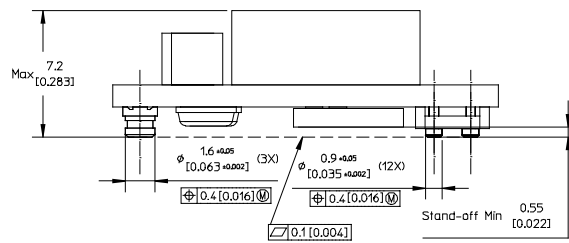

TOP VIEW

Pin positions according to recommended footprint

Pick-up surface, see note

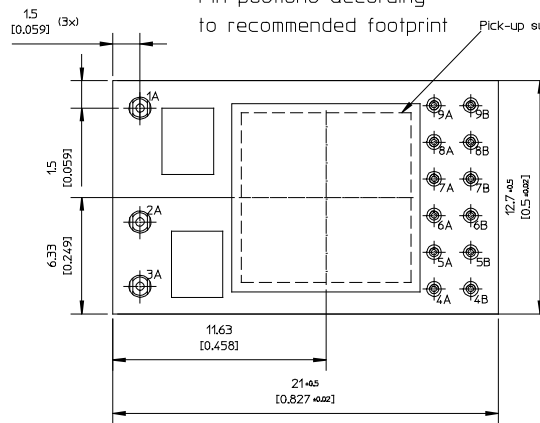

RECOMMENDED FOOTPRINT - TOP VIEW

NOTES

PIN SPECIFICATIONS
 Pin 1A-3A Material: Copper alloy
 Plating: Au 0.1 μm over 1-3 μm Ni.
 Pin 4A-9B Material: Brass
 Plating: Au 0.1 μm over 2 μm Ni.

PICK-UP SURFACE
 Recommended pick-up nozzle size for assigned pick-up area is maximum Ø8 [0.315].

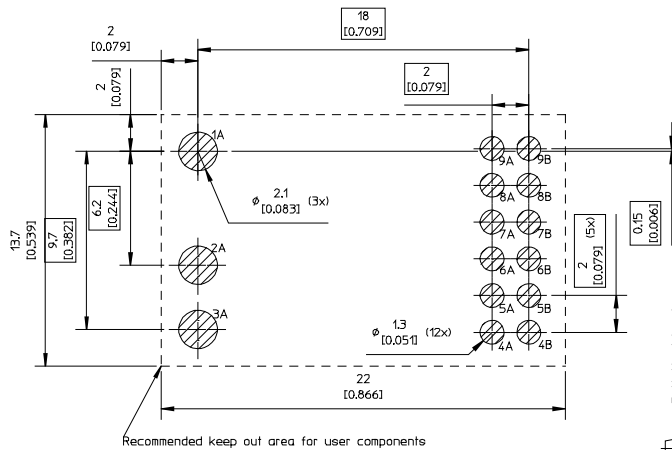

Recommended keep out area for user components



Weight: Typical 4.2 g
 All dimensions in mm [inch].
 Tolerances unless specified:
 x.x ±0.5 mm [0.02]
 x.xx ±0.25 mm [0.01]
 (not applied on footprint or typical values)

BMR462 series PoL Regulators
 Input 4.5-14 V, Output up to 12 A / 60 W

1/28701-BMR 462 Rev.A November 2017
 © Flex

Mechanical Information- SIP version

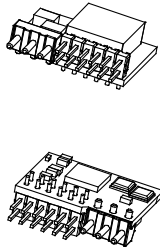

BOTTOM VIEW
 Pin positions according to recommended footprint

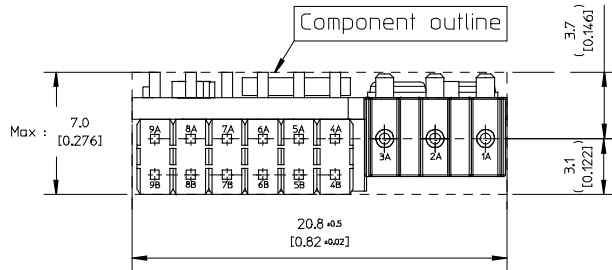

FRONT VIEW

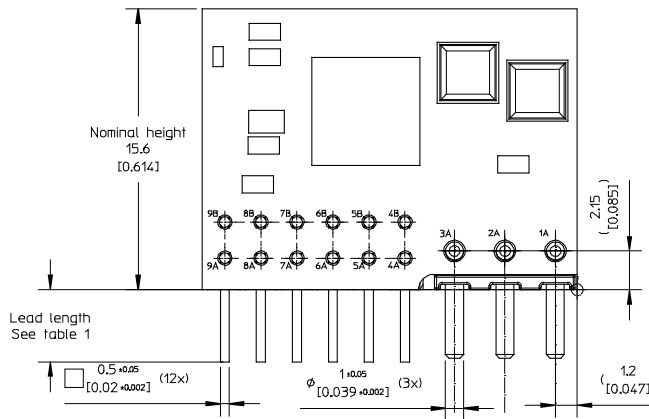

Table 1

| Pin option | Lead Length |
|--------------|----------------------------|
| Standard | 4.0 ± 0.25 [0.157 ± 0.01] |
| Long option | 5.5 ± 0.25 [0.217 ± 0.01] |
| Short option | 3.28 ± 0.25 [0.129 ± 0.01] |

PIN SPECIFICATIONS

Pin 1A-3A Material: Copper alloy (C11000)
 Plating: Min Au 0.1 µm Au over 1-3 µm Ni.
 Pin 4A-9B Material: Copper alloy
 Plating: Min Au 0.1 µm over 1 µm Ni

Weight: Typical 5.1 g
 All dimensions in mm [inch]
 Tolerances unless specified:
 x.x ± 0.50 [0.02]
 x.xx ± 0.25 [0.01]
 (not applied on footprint or typical values)



RECOMMENDED FOOTPRINT - TOP VIEW

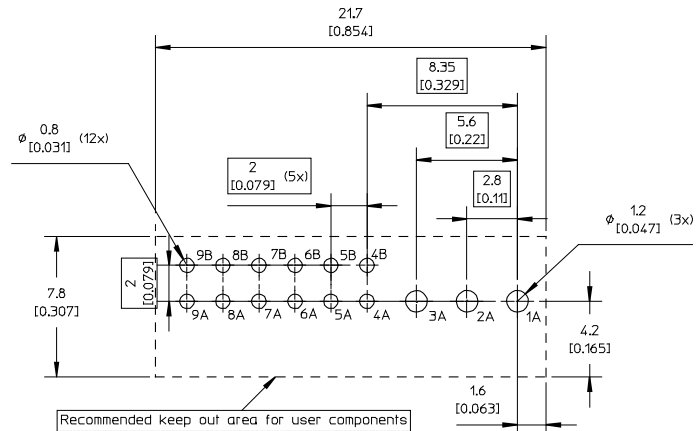

All component placements – whether shown as physical components or symbolical outline – are for reference only and are subject to change throughout the product's life cycle, unless explicitly described and dimensioned in this drawing.

BMR462 series PoL Regulators

Input 4.5-14 V, Output up to 12 A / 60 W

1/28701-BMR 462 Rev.A November 2017

© Flex

Soldering Information - Surface Mounting and Hole Mount through Pin in Paste Assembly (Lay Down version)

The product is intended for forced convection or vapor phase reflow soldering in SnPb or Pb-free processes.

The reflow profile should be optimised to avoid excessive heating of the product. It is recommended to have a sufficiently extended preheat time to ensure an even temperature across the host PWB and it is also recommended to minimize the time in reflow.

A no-clean flux is recommended to avoid entrapment of cleaning fluids in cavities inside the product or between the product and the host board, since cleaning residues may affect long time reliability and isolation voltage.

| General reflow process specifications | | SnPb eutectic | Pb-free |
|---|---------------|---------------|-----------|
| Average ramp-up ($T_{PRODUCT}$) | | 3°C/s max | 3°C/s max |
| Typical solder melting (liquidus) temperature | T_L | 183°C | 221°C |
| Minimum reflow time above T_L | | 60 s | 60 s |
| Minimum pin temperature | T_{PIN} | 210°C | 235°C |
| Peak product temperature | $T_{PRODUCT}$ | 225°C | 260°C |
| Average ramp-down ($T_{PRODUCT}$) | | 6°C/s max | 6°C/s max |
| Maximum time 25°C to peak | | 6 minutes | 8 minutes |

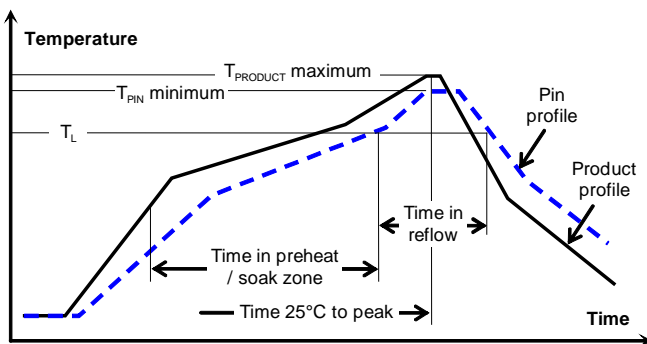
**Minimum Pin Temperature Recommendations**

Pin number 2A is chosen as reference location for the minimum pin temperature recommendation since this will likely be the coolest solder joint during the reflow process.

SnPb solder processes

For SnPb solder processes, a pin temperature (T_{PIN}) in excess of the solder melting temperature, (T_L , 183°C for Sn63Pb37) for more than 60 seconds and a peak temperature of 220°C is recommended to ensure a reliable solder joint.

For dry packed products only: depending on the type of solder paste and flux system used on the host board, up to a recommended maximum temperature of 245°C could be used, if the products are kept in a controlled environment (dry pack handling and storage) prior to assembly.

Lead-free (Pb-free) solder processes

For Pb-free solder processes, a pin temperature (T_{PIN}) in excess of the solder melting temperature (T_L , 217 to 221°C for SnAgCu solder alloys) for more than 60 seconds and a peak temperature of 245°C on all solder joints is recommended to ensure a reliable solder joint.

Maximum Product Temperature Requirements

Top of the product PWB near pin 9B is chosen as reference location for the maximum (peak) allowed product temperature ($T_{PRODUCT}$) since this will likely be the warmest part of the product during the reflow process.

SnPb solder processes

For SnPb solder processes, the product is qualified for MSL 1 according to IPC/JEDEC standard J-STD-020C.

During reflow $T_{PRODUCT}$ must not exceed 225 °C at any time.

Pb-free solder processes

For Pb-free solder processes, the product is qualified for MSL 3 according to IPC/JEDEC standard J-STD-020C.

During reflow $T_{PRODUCT}$ must not exceed 260 °C at any time.

Dry Pack Information

Products intended for Pb-free reflow soldering processes are delivered in standard moisture barrier bags according to IPC/JEDEC standard J-STD-033 (Handling, packing, shipping and use of moisture/reflow sensitivity surface mount devices).

Using products in high temperature Pb-free soldering processes requires dry pack storage and handling. In case the products have been stored in an uncontrolled environment and no longer can be considered dry, the modules must be baked according to J-STD-033.

Thermocouple Attachment

Pin 9B for measurement of maximum Product temperature $T_{PRODUCT}$

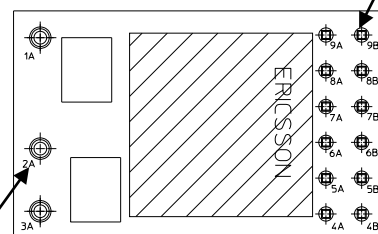

Pin 2A for measurement of minimum Pin (solder joint) temperature T_{PIN}

BMR462 series PoL Regulators
 Input 4.5-14 V, Output up to 12 A / 60 W

1/28701-BMR 462 Rev.A November 2017

© Flex

Soldering Information - Hole Mounting (Lay Down version)

The hole mounted product is intended for plated through hole mounting by wave or manual soldering. The pin temperature is specified to maximum to 270°C for maximum 10 seconds.

A maximum preheat rate of 4°C/s and maximum preheat temperature of 150°C is suggested. When soldering by hand, care should be taken to avoid direct contact between the hot soldering iron tip and the pins for more than a few seconds in order to prevent overheating.

A no-clean flux is recommended to avoid entrapment of cleaning fluids in cavities inside the product or between the product and the host board. The cleaning residues may affect long time reliability and isolation voltage.

Delivery Package Information

The products are delivered in antistatic carrier tape (EIA 481 standard).

| Carrier Tape Specifications | |
|------------------------------------|-----------------------------|
| Material | Antistatic PS |
| Surface resistance | <10 ⁷ Ohm/square |
| Bakeability | The tape is not bakable |
| Tape width, W | 44 mm [1.73 inch] |
| Pocket pitch, P₁ | 24 mm [0.95 inch] |
| Pocket depth, K₀ | 12.3 mm [0.488 inch] |
| Reel diameter | 381 mm [15 inch] |
| Reel capacity | 200 products /reel |
| Reel weight | 1.3 kg/full reel |

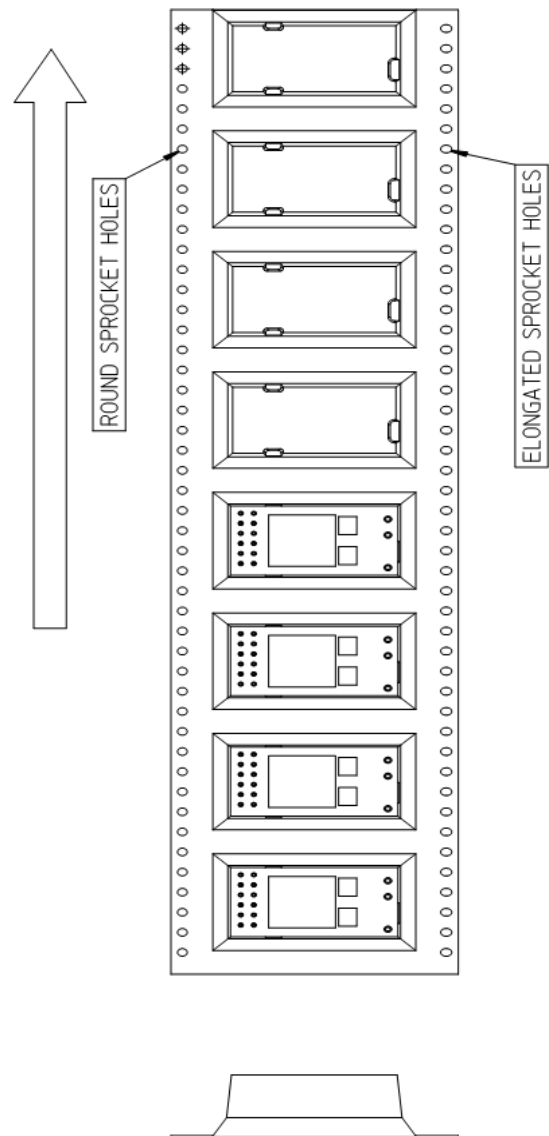

BMR462 series PoL Regulators
 Input 4.5-14 V, Output up to 12 A / 60 W

1/28701-BMR 462 Rev.A November 2017
 © Flex

Soldering Information - Hole Mounting (SIP version)

The product is intended for plated through hole mounting by wave or manual soldering. The pin temperature is specified to maximum to 270°C for maximum 10 seconds.

A maximum preheat rate of 4°C/s and maximum preheat temperature of 150°C is suggested. When soldering by hand, care should be taken to avoid direct contact between the hot soldering iron tip and the pins for more than a few seconds in order to prevent overheating.

A no-clean flux is recommended to avoid entrapment of cleaning fluids in cavities inside the product or between the product and the host board. The cleaning residues may affect long time reliability and isolation voltage.

Delivery Package Information (SIP version)

The products are delivered in antistatic/static dissipative trays

| Tray Specifications | |
|---------------------------|---------------------------------------|
| Material | Antistatic Polyethylene foam |
| Surface resistance | $10^9 < \text{Ohms/square} < 10^{11}$ |
| Bakability | The trays are not bakeable |
| Tray thickness | 15 mm [0.591 inch] |
| Box capacity | 100 products, 2 full trays/box) |
| Tray weight | 35 g empty tray, 290 g full tray |

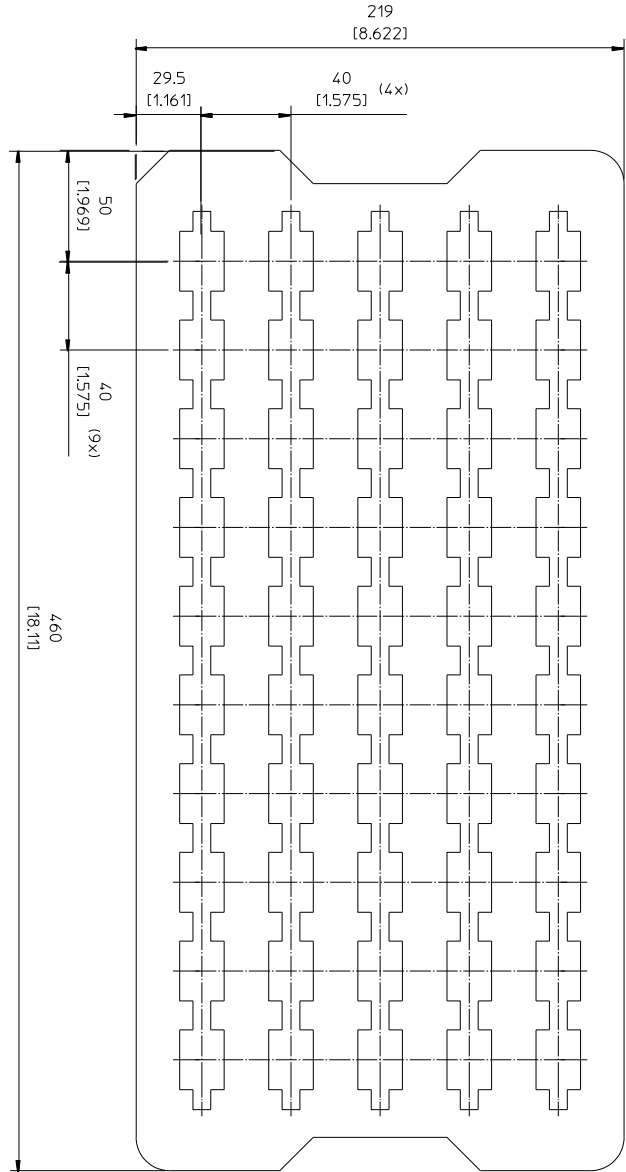

BMR462 series PoL Regulators
Input 4.5-14 V, Output up to 12 A / 60 W

1/28701-BMR 462 Rev.A November 2017

© Flex

Product Qualification Specification

| Characteristics | | | |
|---|--|---|---|
| External visual inspection | IPC-A-610 | | |
| Change of temperature (Temperature cycling) | IEC 60068-2-14 Na | Temperature range Number of cycles Dwell/transfer time | -40 to 100°C 1000 15 min/0-1 min |
| Cold (in operation) | IEC 60068-2-1 Ad | Temperature T _A Duration | -45°C 72 h |
| Damp heat | IEC 60068-2-67 Cy | Temperature Humidity Duration | 85°C 85 % RH 1000 hours |
| Dry heat | IEC 60068-2-2 Bd | Temperature Duration | 125°C 1000 h |
| Electrostatic discharge susceptibility | IEC 61340-3-1, JESD 22-A114 IEC 61340-3-2, JESD 22-A115 | Human body model (HBM) Machine Model (MM) | Class 2, 2000 V Class 3, 200 V |
| Immersion in cleaning solvents | IEC 60068-2-45 XA, method 2 | Water Glycol ether | 55°C 35°C |
| Mechanical shock | IEC 60068-2-27 Ea | Peak acceleration Duration | 100 g 6 ms |
| Moisture reflow sensitivity ¹ | J-STD-020C | Level 1 (SnPb-eutectic) Level 3 (Pb Free) | 225°C 260°C |
| Operational life test | MIL-STD-202G, method 108A | Duration | 1000 h |
| Resistance to soldering heat ² | IEC 60068-2-20 Tb, method 1A | Solder temperature Duration | 270°C 10-13 s |
| Robustness of terminations | IEC 60068-2-21 Test Ua1 IEC 60068-2-21 Test Ue1 | Through hole mount products Surface mount products | All leads All leads |
| Solderability | IEC 60068-2-58 test Td ¹ | Preconditioning Temperature, SnPb Eutectic Temperature, Pb-free | 150°C dry bake 16 h 215°C 235°C |
| | IEC 60068-2-20 test Ta ² | Preconditioning Temperature, SnPb Eutectic Temperature, Pb-free | Steam ageing 235°C 245°C |
| Vibration, broad band random | IEC 60068-2-64 Fh, method 1 | Frequency Spectral density Duration | 10 to 500 Hz 0.07 g ² /Hz 10 min in each direction |

Notes

¹ Only for products intended for reflow soldering (surface mount products)

² Only for products intended for wave soldering (plated through hole products)

X-ON Electronics

Largest Supplier of Electrical and Electronic Components

Click to view similar products for [Non-Isolated DC/DC Converters](#) category:

Click to view products by [Flex Power Modules](#) manufacturer:

Other Similar products are found below :

[DP8160G-S1-R1](#) [BRFS50](#) [APTH003A0X-SRZ](#) [SPM1004-3V3C](#) [APXW012A0X3-SRDZ](#) [R-785.0-05](#) [BRFS30](#) [PJT020A0X43-SRZ](#) [CONN-KIT](#) [10E24-P15-10PPM](#) [1E24-P4-25PPM-SHV-5KV](#) [4D15-N1](#) [MYGTM01210BZN](#) [APXW012A0X3-SRDZ](#) [I6A24008A033V-N00-R](#) [10C24-N250-I10-AQ-DA](#) [4AA24-P20-M-H](#) [DX150N](#) [3V12-N0.8](#) [2HVA24-BP1-F-25PPM-SHV-5KV](#) [5HVA24-BP1-F-25PPM-SHV-5KV](#) [1/2AA24-P30-I10](#) [1C24-P20-M-C](#) [VI-920194B](#) [T31SN24005NMFA](#) [3V24-P1](#) [3V24-N1](#) [BMR4672010/001](#) [BMR4652010/001](#) [BMR4668004/001](#) [T31SN12008NMFA](#) [BMR4614001/001](#) [BMR4613001/001](#) [BMR4612001/001](#) [6AA24-P30-I5-M](#) [6AA24-N30-I5-M](#) [1AA12-N4-I5-M](#) [1AA12-P4-I5-M](#) [1.5M24-P1](#) [1.5M24-N1](#) [PTV03020WAH](#) [PTV05020WAH](#) [PTV12010LAH](#) [PTV12020WAD](#) [R-625.0D](#) [R-7212D](#) [R-7212P](#) [R-745.0D](#) [R-78AA15-0.5SMD](#) [R-78AA5.0-1.0SMD](#)