

PKM 4000C PINB series Direct Converters  
 Input 36-75 V, Output up to 100 A / 204 W

EN/LZT 146 415 R5A Oct. 2017

© Flex

### Key Features

- Industry standard Quarter-brick and optional double pin-out. 57.9 x 36.8 x 9.35 mm (2.28 x 1.45 x 0.368 in)
- High efficiency, typ. 94.3% at 12 Vout half load
- 2250 Vdc input to output isolation
- Meets isolation requirements equivalent to basic insulation according to IEC/EN/UL 60950-1
- More than 1.4 million hours MTBF



### General Characteristics

- Output over voltage protection
- Over temperature protection
- Output short-circuit protection
- Hiccup over current protection
- Remote control
- Output voltage adjust function
- Highly automated manufacturing ensures quality
- ISO 9001/14001 certified supplier

### Safety Approvals



### Design for Environment



Meets requirements in high-temperature lead-free soldering processes.

### Contents

Ordering Information	2
General Information	2
Safety Specification	3
Absolute Maximum Ratings	4
Electrical Specification	
1.5V, 100 A / 150 W	PKM 4218HC PINBHC ..... 5
1.8V, 100 A / 180 W	PKM 4218GC PINBHC ..... 9
3.3V, 50 A / 165 W	PKM 4110C PINBHC ..... 13
5.0V, 40 A / 200 W	PKM 4211C PINBHC ..... 17
12V, 17 A / 204 W	PKM 4213C PINBHCSP ..... 21
EMC Specification	25
Operating Information	26
Thermal Consideration	27
Connections	29
Mechanical Information	30
Soldering Information	32
Delivery Information	34
Product Qualification Specification	35

PKM 4000C PINB series Direct Converters  
Input 36-75 V, Output up to 100 A / 204 W

EN/LZT 146 415 R5A Oct. 2017

© Flex

### Ordering Information

Product program	Output
PKM 4218HC	1.5 V, 100 A / 150 W
PKM 4218GC	1.8 V, 100 A / 180 W
PKM 4110C	3.3 V, 50 A / 165 W
PKM 4211C	5 V, 40 A / 200 W
PKM 4213C	12 V, 17 A / 204 W

### Product number and Packaging

PKM 4XXXD P I n <sub>1</sub> n <sub>2</sub> n <sub>3</sub> n <sub>4</sub> n <sub>5</sub>						
Options	n <sub>1</sub>	n <sub>2</sub>	n <sub>3</sub>	n <sub>4</sub>	n <sub>5</sub>	N
Remote Control logic	o					
Baseplate		o				
Hiccup OCP			o			
Single Pin				o		
Increased stand-off height					o	
Lead length						o

Options	Description
n <sub>1</sub>	P Negative * Positive
n <sub>2</sub>	NB Without baseplate * With baseplate
n <sub>3</sub>	HC Hiccup OCP*
n <sub>4</sub>	SP Double pin * Single pin
n <sub>5</sub>	M Standard stand-off height * Increased stand-off height
n <sub>6</sub>	LA 5.33 mm * LB note1 3.69 mm 4.57 mm

Example a through-hole mounted, positive logic, no base plate, short pin product with increased stand-off height would be PKM 4111DPIPMBMLB.

\* Standard variant (i.e. no option selected).  
Note1: LB option only available for NB option.

### General Information

#### Reliability

The failure rate ( $\lambda$ ) and mean time between failures (MTBF =  $1/\lambda$ ) is calculated at max output power and an operating ambient temperature ( $T_A$ ) of +40°C. Flex uses Telcordia SR-332 Issue 2 Method 1 to calculate the mean steady-state failure rate and standard deviation ( $\sigma$ ).

Telcordia SR-332 Issue 2 also provides techniques to estimate the upper confidence levels of failure rates based on the mean and standard deviation.

Mean steady-state failure rate,  $\lambda$  Std. deviation,  $\sigma$   
299 nFailures/h 42.3 nFailures/h  
MTBF (mean value) for the PKM4000D series = 3.3 Mh.

MTBF at 90% confidence level = 2.8 Mh

### Compatibility with RoHS requirements

The products are compatible with the relevant clauses and requirements of the RoHS directive 2002/95/EC and have a maximum concentration value of 0.1% by weight in homogeneous materials for lead, mercury, hexavalent chromium, PBB and PBDE and of 0.01% by weight in homogeneous materials for cadmium.

Exemptions in the RoHS directive utilized in Flex products include:

- Lead in high melting temperature type solder (used to solder the die in semiconductor packages)
- Lead in glass of electronics components and in electronic ceramic parts (e.g. fill material in chip resistors)
- Lead as an alloying element in copper alloy containing up to 4% lead by weight (used in connection pins made of Brass)

### Quality Statement

The products are designed and manufactured in an industrial environment where quality systems and methods like ISO 9000, 6 $\sigma$  (sigma), and SPC are intensively in use to boost the continuous improvements strategy. Infant mortality or early failures in the products are screened out and they are subjected to an ATE-based final test. Conservative design rules, design reviews and product qualifications, plus the high competence of an engaged work force, contribute to the high quality of our products.

### Warranty

Warranty period and conditions are defined in Flex General Terms and Conditions of Sale.

### Limitation of Liability

Flex does not make any other warranties, expressed or implied including any warranty of merchantability or fitness for a particular purpose (including, but not limited to, use in life support applications, where malfunctions of product can cause injury to a person's health or life).

### © Flex 2017

The information and specifications in this technical specification is believed to be correct at the time of publication. However, no liability is accepted for inaccuracies, printing errors or for any consequences thereof. Flex reserves the right to change the contents of this technical specification at any time without prior notice.

PKM 4000C PINB series Direct Converters Input 36-75 V, Output up to 100 A / 204 W	EN/LZT 146 415 R5A Oct. 2017
	© Flex

## Safety Specification

### General information

Flex DC/DC converters and DC/DC regulators are designed in accordance with the safety standards IEC 60950-1, EN 60950-1 and UL 60950-1 *Safety of Information Technology Equipment*.

IEC/EN/UL 60950-1 contains requirements to prevent injury or damage due to the following hazards:

- Electrical shock
- Energy hazards
- Fire
- Mechanical and heat hazards
- Radiation hazards
- Chemical hazards

On-board DC/DC converters and DC/DC regulators are defined as component power supplies. As components they cannot fully comply with the provisions of any safety requirements without "conditions of acceptability". Clearance between conductors and between conductive parts of the component power supply and conductors on the board in the final product must meet the applicable safety requirements. Certain conditions of acceptability apply for component power supplies with limited stand-off (see Mechanical Information and Safety Certificate for further information). It is the responsibility of the installer to ensure that the final product housing these components complies with the requirements of all applicable safety standards and regulations for the final product.

Component power supplies for general use should comply with the requirements in IEC/EN/UL 60950-1 *Safety of Information Technology Equipment*. Product related standards, e.g. IEEE 802.3af *Power over Ethernet*, and ETS-300132-2 *Power interface at the input to telecom equipment, operated by direct current (dc)* are based on IEC/EN/UL 60950-1 with regards to safety.

Flex DC/DC converters, Power interface modules and DC/DC regulators are UL 60950-1 recognized and certified in accordance with EN 60950-1. The flammability rating for all construction parts of the products meet requirements for V-0 class material according to IEC 60695-11-10, *Fire hazard testing, test flames – 50 W horizontal and vertical flame test methods*.

### Isolated DC/DC converters & Power interface modules

The product may provide basic or functional insulation between input and output according to IEC/EN/UL 60950-1 (see Safety Certificate), different conditions shall be met if the output of a basic or a functional insulated product shall be considered as safety extra low voltage (SELV).

For basic insulated products (see Safety Certificate) the output is considered as safety extra low voltage (SELV) if one of the following conditions is met:

- The input source provides supplementary or double or reinforced insulation from the AC mains according to IEC/EN/UL 60950-1.
- The input source provides functional or basic insulation from the AC mains and the product's output is reliably connected to protective earth according to IEC/EN/UL 60950-1.

For functional insulated products (see Safety Certificate) the output is considered as safety extra low voltage (SELV) if one of the following conditions is met:

- The input source provides double or reinforced insulation from the AC mains according to IEC/EN/UL 60950-1.
- The input source provides basic or supplementary insulation from the AC mains and the product's output is reliably connected to protective earth according to IEC/EN/UL 60950-1.
- The input source is reliably connected to protective earth and provides basic or supplementary insulation according to IEC/EN/UL 60950-1 and the maximum input source voltage is 60 Vdc.

Galvanic isolation between input and output is verified in an electric strength test and the isolation voltage ( $V_{iso}$ ) meets the voltage strength requirement for basic insulation according to IEC/EN/UL 60950-1.

It is recommended to use a slow blow fuse at the input of each DC/DC converter. If an input filter is used in the circuit the fuse should be placed in front of the input filter. In the rare event of a component problem that imposes a short circuit on the input source, this fuse will provide the following functions:

- Isolate the fault from the input power source so as not to affect the operation of other parts of the system
- Protect the distribution wiring from excessive current and power loss thus preventing hazardous overheating

PKM 4000C PINB series Direct Converters  
 Input 36-75 V, Output up to 100 A / 204 W

EN/LZT 146 415 R5A Oct. 2017

© Flex

### Absolute Maximum Ratings

Characteristics		min	typ	max	Unit
$T_{P1}$	Operating Temperature (see Thermal Consideration section)	-40		+110	°C
$T_S$	Storage temperature	-55		+125	°C
$V_I$	Input voltage	-0.5		+80	V
$V_{iso}$	Isolation voltage (input to output test voltage)			2250	Vdc
$V_{tr}$	Input voltage transient ( $t_p$ 100 ms)			100	V
$V_{RC}$	Remote Control pin voltage (see Operating Information section)	Positive logic option		+15	V
		Negative logic option		+15	V
$V_{adj}$	Adjust pin voltage (see Operating Information section)	-0.5		+5	V

Stress in excess of Absolute Maximum Ratings may cause permanent damage. Absolute Maximum Ratings, sometimes referred to as no destruction limits, are normally tested with one parameter at a time exceeding the limits in the Electrical Specification. If exposed to stress above these limits, function and performance may degrade in an unspecified manner.

### Fundamental Circuit Diagram

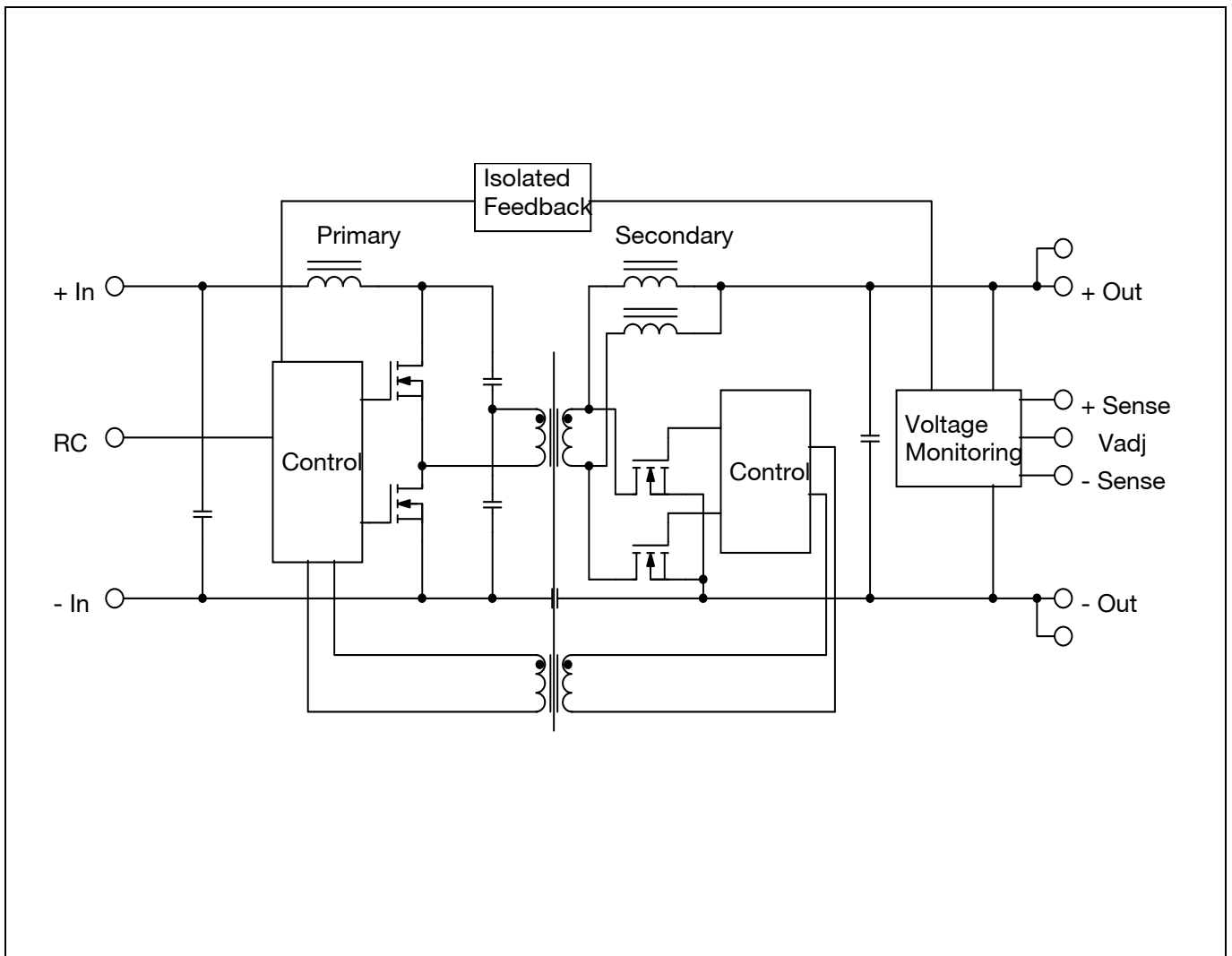

PKM 4000C PINB series Direct Converters  
 Input 36-75 V, Output up to 100 A / 204 W

EN/LZT 146 415 R5A Oct. 2017

© Flex

**1.5V, 100A/150W Electrical Specification**

**PKM 4218HC PINBHC**

$T_{P1} = -40$  to  $+90^{\circ}\text{C}$ ,  $V_I = 36$  to  $75$  V, sense pins connected to output pins unless otherwise specified under Conditions.

Typical values given at:  $T_{P1} = +25^{\circ}\text{C}$ ,  $V_I = 53$  V, max  $I_O$ , unless otherwise specified under Conditions.

Additional  $C_{in} = 0$   $\mu\text{F}$ . See Operating Information section for selection of capacitor types.

Characteristics		Conditions	min	typ	max	Unit
$V_I$	Input voltage range		36		75	V
$V_{loff}$	Turn-off input voltage	Decreasing input voltage	30	31	32	V
$V_{lon}$	Turn-on input voltage	Increasing input voltage	32	33	34	V
$C_I$	Internal input capacitance			6.0		$\mu\text{F}$
$P_O$	Output power		0		150	W
$\eta$	Efficiency	50 % of max $I_O$		90.7		%
		max $I_O$		87.1		
		50 % of max $I_O$ , $V_I = 48$ V		91.8		
		max $I_O$ , $V_I = 48$ V		86.9		
$P_d$	Power Dissipation	max $I_O$		22.5	30	W
$P_{li}$	Input idling power	$I_O = 0$ A, $V_I = 53$ V		2.5		W
$P_{RC}$	Input standby power	$V_I = 53$ V (turned off with RC)		0.14		W
$f_s$	Switching frequency	0-100 % of max $I_O$	140	155	170	kHz

$V_{Oi}$	Output voltage initial setting and accuracy	$T_{P1} = +25^{\circ}\text{C}$ , $V_I = 53$ V, $I_O = 100$ A	1.47	1.50	1.53	V
$V_O$	Output adjust range	See operating information	1.35		1.65	V
	Output voltage tolerance band	0-100 % of max $I_O$	1.45		1.55	V
	Idling voltage	$I_O = 0$ A	1.47		1.53	V
	Line regulation	max $I_O$		3	5	mV
	Load regulation	$V_I = 53$ V, 0-100 % of max $I_O$		10	15	mV
$V_{tr}$	Load transient voltage deviation	$V_I = 53$ V, Load step 25-75-25 % of max $I_O$ , $di/dt = 5\text{A}/\mu\text{s}$ , see Note 1		$\pm 300$	$\pm 450$	mV
$t_{tr}$	Load transient recovery time			100	150	$\mu\text{s}$
$t_r$	Ramp-up time (from 10-90 % of $V_{Oi}$ )	10-100 % of max $I_O$	1.5	3	5	ms
$t_s$	Start-up time (from $V_I$ connection to 90 % of $V_{Oi}$ )		8	15	20	ms
$t_f$	$V_I$ shut-down fall time (from $V_I$ off to 10 % of $V_O$ )	max $I_O$		0.067		ms
		$I_O = 0.2$ A		12		ms
$t_{RC}$	RC start-up time	max $I_O$		15		ms
	RC shut-down fall time (from RC off to 10 % of $V_O$ )	max $I_O$		0.03		ms
		$I_O = 0.2$ A		10		ms
$I_O$	Output current		0		100	A
$I_{lim}$	Current limit threshold	$T_{P1} < \text{max } T_{P1}$	105	125	150	A
$I_{sc}$	Short circuit current	$T_{P1} = 25^{\circ}\text{C}$ , see Note 2		31		A
$C_{out}$	Recommended Capacitive Load	$T_{P1} = 25^{\circ}\text{C}$ , see Note 3	0		10000	$\mu\text{F}$
$V_{Oac}$	Output ripple & noise	See ripple & noise section, max $I_O$ , $V_{Oi}$		100	280	mVp-p
OVP	Over voltage protection	$T_{P1} = +25^{\circ}\text{C}$ , $V_I = 53$ V, 0-100 % of max $I_O$		1.95		V

Note 1: 10000 $\mu\text{F}$  aluminium solid capacitors are connected to the module.

Note 2: Hic-cup mode, the value is in RMS, short circuit load is 5mohm.

Note 3: Aluminium electrolytic capacitors, ESR is lower than 10 mohm.

PKM 4000C PINB series Direct Converters  
 Input 36-75 V, Output up to 100 A / 204 W

EN/LZT 146 415 R5A Oct. 2017

© Flex

1.5V, 100A /150W Typical Characteristics

PKM 4218HC PINBHC

Efficiency

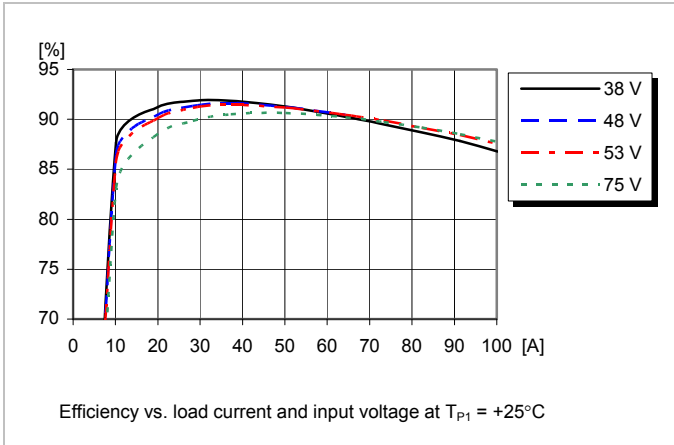

Power Dissipation

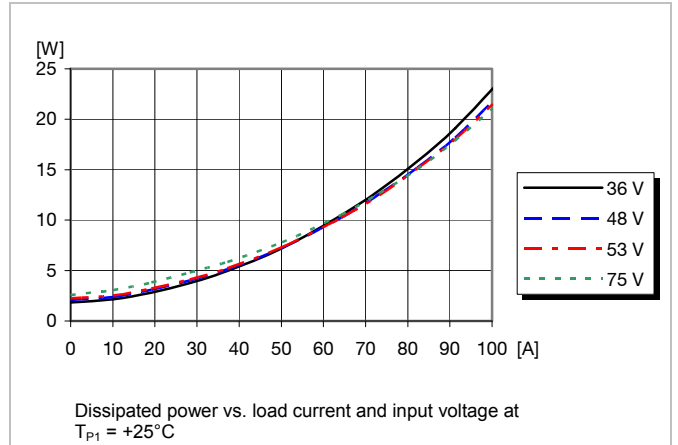

Output Characteristics

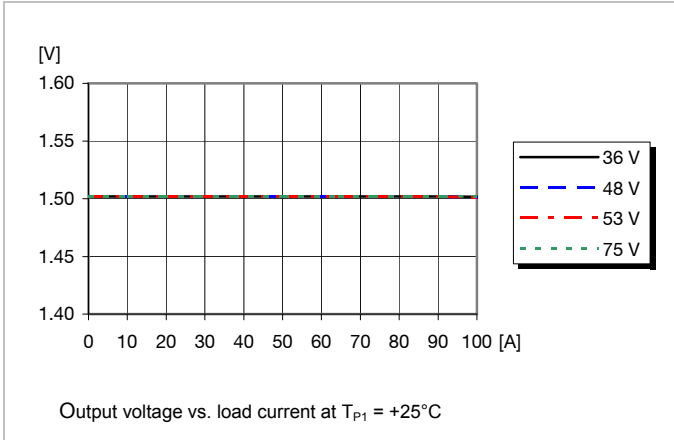

Current Limit Characteristics

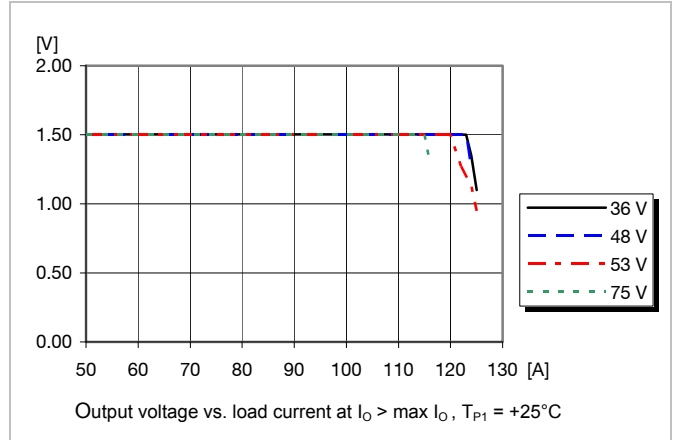

1.5V, 100A /150W Typical Characteristics

PKM 4218HC PINBHC

Start-up

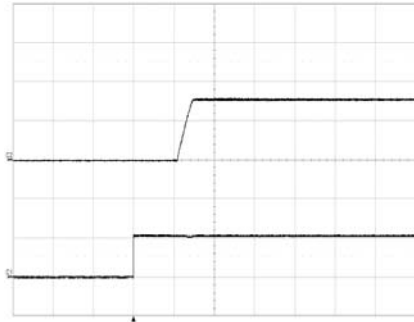

Start-up enabled by connecting  $V_i$  at:  
 $T_{P1} = +25^{\circ}\text{C}$ ,  $V_i = 53\text{ V}$ ,  
 $I_o = 100\text{ A}$  resistive load.

Top trace: output voltage (1V/div.).  
Bottom trace: input voltage (50 V/div.).  
Time scale: (10 ms/div.).

Shut-down

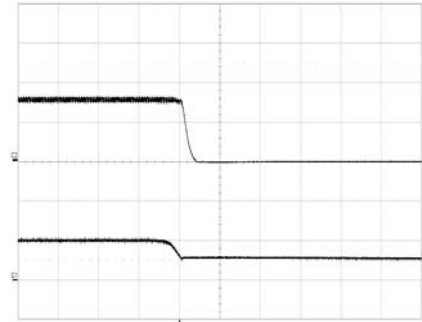

Shut-down enabled by disconnecting  $V_i$  at:  
 $T_{P1} = +25^{\circ}\text{C}$ ,  $V_i = 53\text{ V}$ ,  
 $I_o = 100\text{ A}$  resistive load.

Top trace: output voltage (1 V/div.).  
Bottom trace: input voltage (50 V/div.).  
Time scale: (0.1 ms/div.).

Output Ripple & Noise

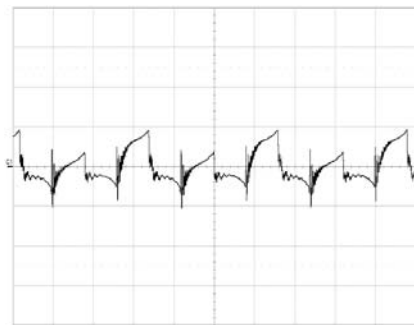

Output voltage ripple at:  
 $T_{P1} = +25^{\circ}\text{C}$ ,  $V_i = 53\text{ V}$ ,  
 $I_o = 100\text{ A}$  resistive load.

Trace: output voltage (50 mV/div.).  
Time scale: (2  $\mu\text{s}$ /div.).

Output Load Transient Response

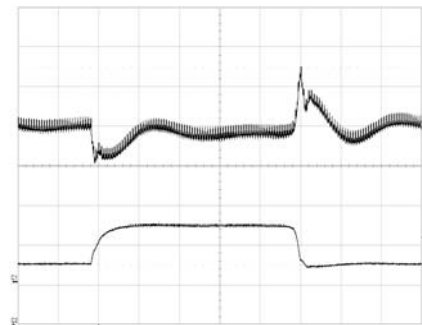

Output voltage response to load current step-change (25-75-25 A) at:  
 $T_{P1} = +25^{\circ}\text{C}$ ,  $V_i = 53\text{ V}$ .

Top trace: output voltage (200mV/div.).  
Bottom trace: load current (50 A/div.).  
Time scale: (0.1 ms/div.).

Output Voltage Adjust (see operating information)

Passive adjust

The resistor value for an adjusted output voltage is calculated by using the following equations:

Output Voltage Adjust Upwards, Increase:

$$R_{adj} = 5.11 \left( \frac{V_o(100 + \Delta\%) - 100 + 2 \times \Delta\%}{1.225 \times \Delta\%} - \frac{100 + 2 \times \Delta\%}{\Delta\%} \right) \text{k}\Omega$$

Example: Increase 4%  $\Rightarrow V_{out} = 1.56\text{ Vdc}$

$$R_{adj} = 5.11 \left( \frac{1.5 \times (100 + 4) - 100 + 2 \times 4}{1.225 \times 4} - \frac{100 + 2 \times 4}{4} \right) \text{k}\Omega = 24.7\text{ k}\Omega$$

Output Voltage Adjust downwards, Decrease:

$$R_{adj} = 5.11 \left( \frac{100}{\Delta\%} - 2 \right) \text{k}\Omega$$

Example: Decrease 4%  $\Rightarrow V_{out} = 1.44\text{ Vdc}$

$$R_{adj} = 5.11 \left( \frac{100}{4} - 2 \right) \text{k}\Omega = 117\text{ k}\Omega$$

PKM 4000C PINB series Direct Converters  
Input 36-75 V, Output up to 100 A / 204 W

EN/LZT 146 415 R5A Oct. 2017

© Flex

1.5V, 100A /150W Typical Characteristics

PKM 4218HC PINBHC

Output Current Derating – Open frame

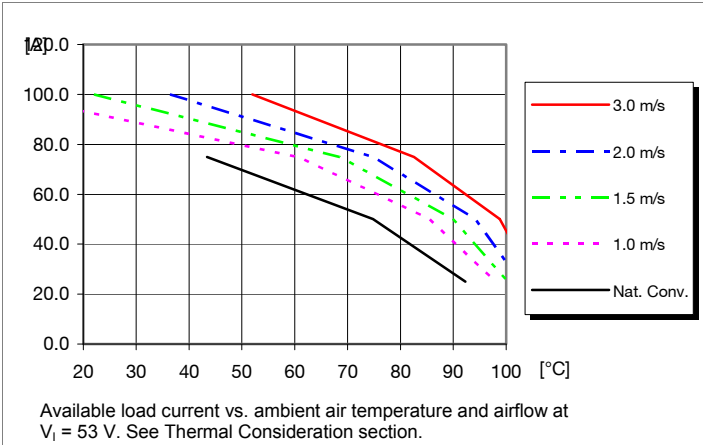

Output Current Derating – Base plate

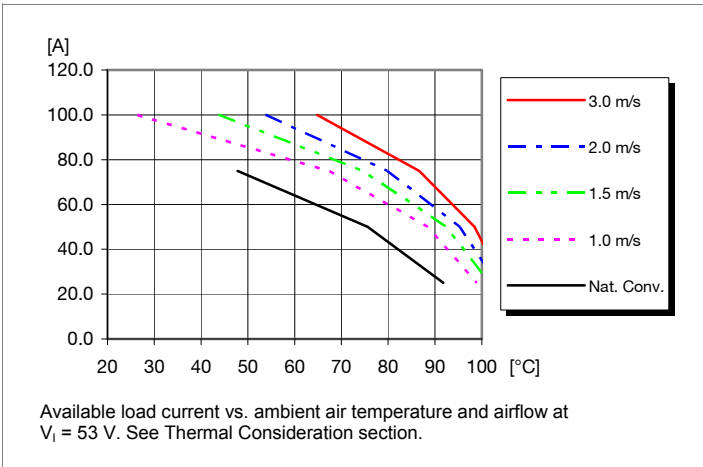

Thermal Resistance – Base plate

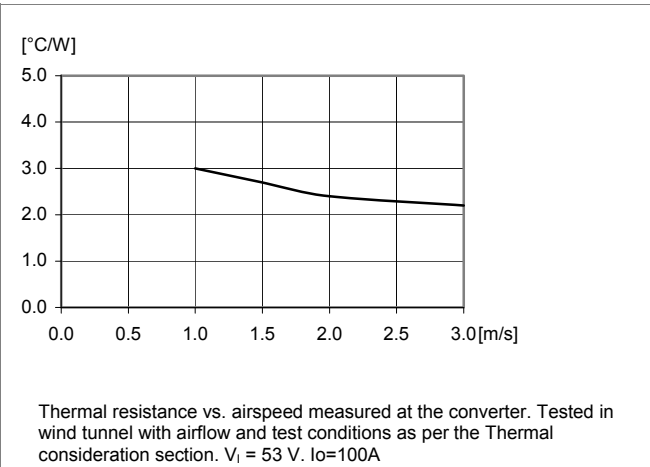

Output Current Derating – Cold wall sealed box

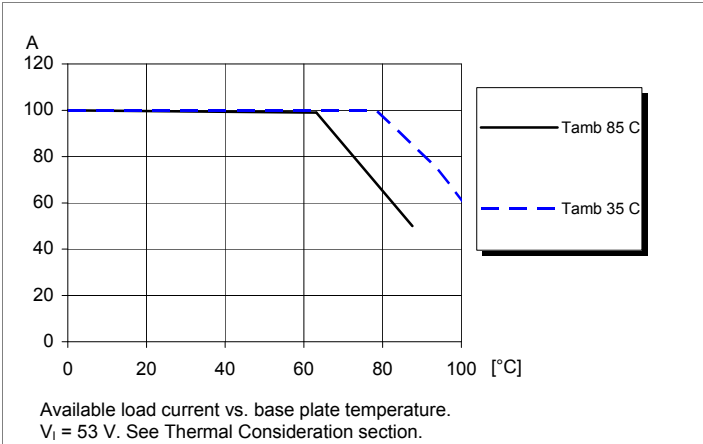



**PKM 4000C PINB series Direct Converters**  
 Input 36-75 V, Output up to 100 A / 204 W

EN/LZT 146 415 R5A Oct. 2017

© Flex

**1.8V, 100A/180W Electrical Specification**

**PKM 4218GC PINBHC**

$T_{P1} = -40$  to  $+90^{\circ}\text{C}$ ,  $V_I = 36$  to  $75$  V, sense pins connected to output pins unless otherwise specified under Conditions.

Typical values given at:  $T_{P1} = +25^{\circ}\text{C}$ ,  $V_I = 53$  V, max  $I_O$ , unless otherwise specified under Conditions.

Additional  $C_{in} = 33$   $\mu\text{F}$ . See Operating Information section for selection of capacitor types.

Characteristics		Conditions	min	typ	max	Unit
$V_I$	Input voltage range		36		75	V
$V_{loff}$	Turn-off input voltage	Decreasing input voltage	30	31	32	V
$V_{lon}$	Turn-on input voltage	Increasing input voltage	32	33	34	V
$C_I$	Internal input capacitance			6.0		$\mu\text{F}$
$P_O$	Output power		0		180	W
$\eta$	Efficiency	50 % of max $I_O$		91.5		%
		max $I_O$		88.5		
		50 % of max $I_O$ , $V_I = 48$ V		91.5		
		max $I_O$ , $V_I = 48$ V		88.0		
$P_d$	Power Dissipation	max $I_O$		24	32	W
$P_{li}$	Input idling power	$I_O = 0$ A, $V_I = 53$ V		2.8		W
$P_{RC}$	Input standby power	$V_I = 53$ V (turned off with RC)		0.14		W
$f_s$	Switching frequency	0-100 % of max $I_O$	140	155	170	kHz

$V_{Oi}$	Output voltage initial setting and accuracy	$T_{P1} = +25^{\circ}\text{C}$ , $V_I = 53$ V, $I_O = 100$ A	1.76	1.80	1.84	V
$V_O$	Output adjust range	See operating information	1.62		1.98	V
	Output voltage tolerance band	0-100 % of max $I_O$	1.75		1.85	V
	Idling voltage	$I_O = 0$ A	1.76		1.84	V
	Line regulation	max $I_O$		10	15	mV
	Load regulation	$V_I = 53$ V, 0-100 % of max $I_O$		10	15	mV
$V_{tr}$	Load transient voltage deviation	$V_I = 53$ V, Load step 25-75-25 % of max $I_O$ , $di/dt = 3\text{A}/\mu\text{s}$ , see Note 1		$\pm 280$	$\pm 450$	mV
$t_{tr}$	Load transient recovery time			110	350	$\mu\text{s}$
$t_r$	Ramp-up time (from 10-90 % of $V_{Oi}$ )	10-100 % of max $I_O$	1.5	3	4.5	ms
$t_s$	Start-up time (from $V_I$ connection to 90 % of $V_{Oi}$ )		8	15	20	ms
$t_f$	$V_I$ shut-down fall time (from $V_I$ off to 10 % of $V_O$ )	max $I_O$		0.4		ms
		$I_O = 0.2$ A		40		ms
$t_{RC}$	RC start-up time	max $I_O$		15		ms
	RC shut-down fall time (from RC off to 10 % of $V_O$ )	max $I_O$		0.03		ms
		$I_O = 0.2$ A		12		ms
$I_O$	Output current		0		100	A
$I_{lim}$	Current limit threshold	$T_{P1} < \text{max } T_{P1}$	105	125	150	A
$I_{sc}$	Short circuit current	$T_{P1} = 25^{\circ}\text{C}$ , see Note 2		31		A
$C_{out}$	Recommended Capacitive Load	$T_{P1} = 25^{\circ}\text{C}$ , see Note 3	0		10000	$\mu\text{F}$
$V_{Oac}$	Output ripple & noise	See ripple & noise section, max $I_O$ , $V_{Oi}$		120	240	mVp-p
OVP	Over voltage protection	$T_{P1} = +25^{\circ}\text{C}$ , $V_I = 53$ V, 0-100 % of max $I_O$	2.2	2.5	2.8	V

Note 1: 10000 $\mu\text{F}$  aluminium solid capacitors are connected to the module.

Note 2: Hic-cup mode, the value is in RMS, short circuit load is 5mohm.

Note 3: Aluminium electrolytic capacitors, ESR is lower than 10 mohm.

PKM 4000C PINB series Direct Converters  
 Input 36-75 V, Output up to 100 A / 204 W

EN/LZT 146 415 R5A Oct. 2017

© Flex

**1.8V, 100A /180W Typical Characteristics**

**PKM 4218GC PINBHC**

**Efficiency**

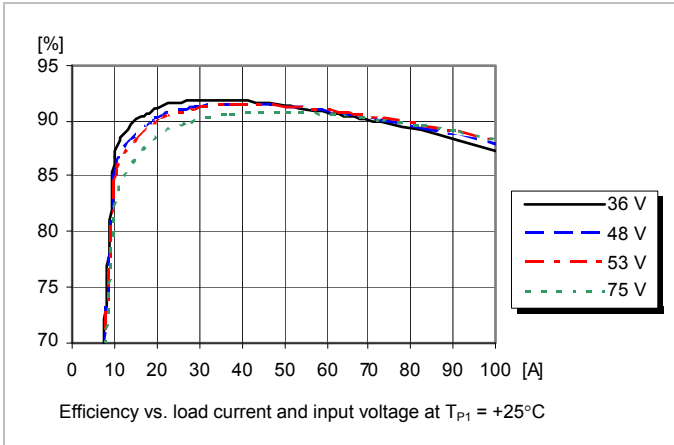

**Power Dissipation**

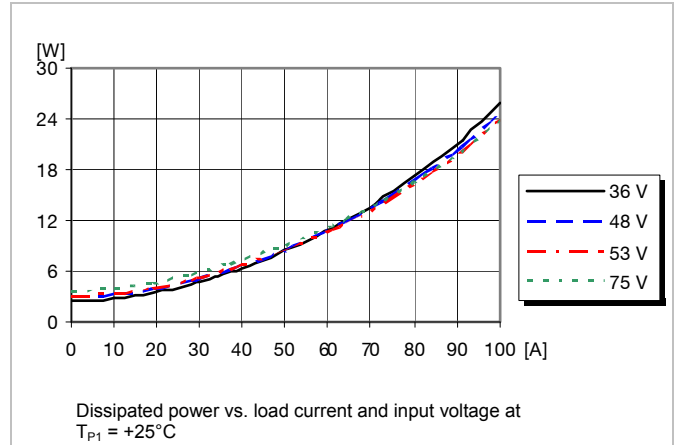

**Output Characteristics**

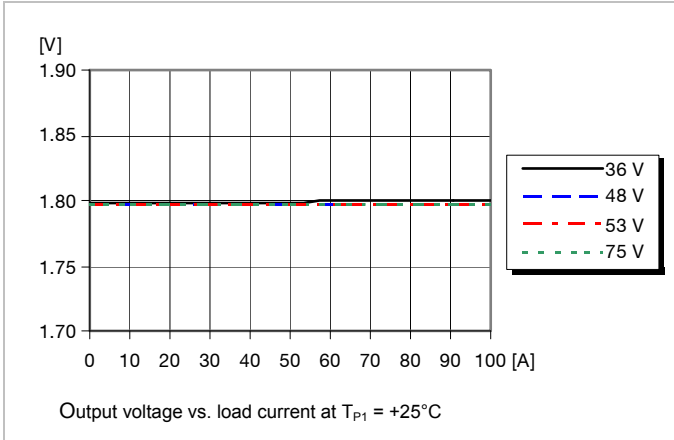

**Current Limit Characteristics**

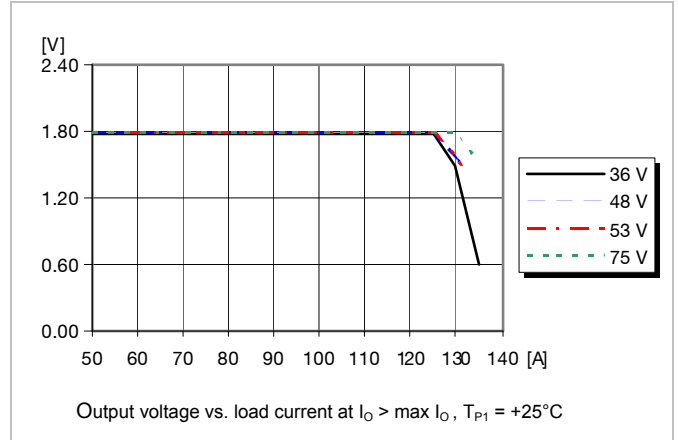

PKM 4000C PINB series Direct Converters  
 Input 36-75 V, Output up to 100 A / 204 W

EN/LZT 146 415 R5A Oct. 2017

© Flex

**1.8V, 100A /180W Typical Characteristics**

**PKM 4218GC PINBHC**

**Start-up**

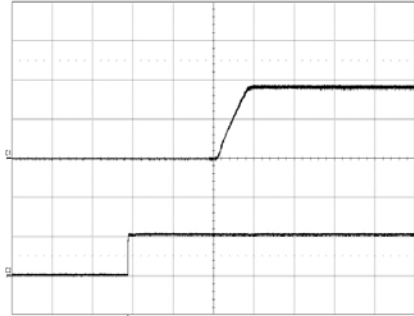

Start-up enabled by connecting  $V_i$  at:  
 $T_{P1} = +25^{\circ}\text{C}$ ,  $V_i = 53\text{ V}$ ,  
 $I_o = 100\text{ A}$  resistive load.

Top trace: output voltage (1V/div.).  
 Bottom trace: input voltage (50 V/div.).  
 Time scale: (5 ms/div.).

**Shut-down**

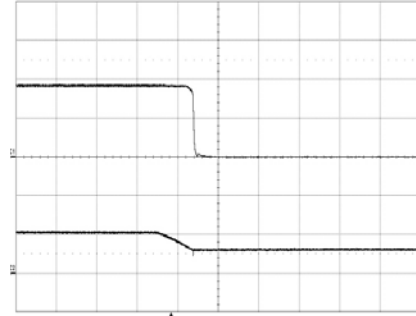

Shut-down enabled by disconnecting  $V_i$  at:  
 $T_{P1} = +25^{\circ}\text{C}$ ,  $V_i = 53\text{ V}$ ,  
 $I_o = 100\text{ A}$  resistive load.

Top trace: output voltage (1 V/div.).  
 Bottom trace: input voltage (50 V/div.).  
 Time scale: (0.5 ms/div.).

**Output Ripple & Noise**

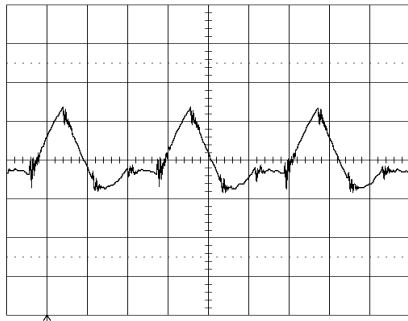

Output voltage ripple at:  
 $T_{P1} = +25^{\circ}\text{C}$ ,  $V_i = 53\text{ V}$ ,  
 $I_o = 100\text{ A}$  resistive load.

Trace: output voltage (50 mV/div.).  
 Time scale: (2 μs/div.).

**Output Load Transient Response**

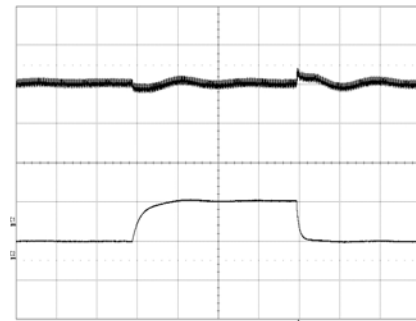

Output voltage response to load current step-change (25-75-25 A) at:  
 $T_{P1} = +25^{\circ}\text{C}$ ,  $V_i = 53\text{ V}$ .

Top trace: output voltage (200 mV/div.).  
 Bottom trace: load current (50 A/div.).  
 Time scale: (0.2 ms/div.).

**Output Voltage Adjust (see operating information)**

**Passive adjust**

The resistor value for an adjusted output voltage is calculated by using the following equations:

Output Voltage Adjust Upwards, Increase:

$$R_{adj} = 5.11 \left( \frac{V_o(100 + \Delta\%) - 100 + 2 \times \Delta\%}{1.225 \times \Delta\%} - \frac{100 + 2 \times \Delta\%}{\Delta\%} \right) \text{k}\Omega$$

Example: Increase 4% =>  $V_{out} = 1.872\text{ Vdc}$

$$R_{adj} = 5.11 \left( \frac{1.8 \times (100 + 4)}{1.225 \times 4} - \frac{100 + 2 \times 4}{4} \right) \text{k}\Omega = 57.3\text{ k}\Omega$$

Output Voltage Adjust downwards, Decrease:

$$R_{adj} = 5.11 \left( \frac{100}{\Delta\%} - 2 \right) \text{k}\Omega$$

Example: Decrease 4% =>  $V_{out} = 1.728\text{ Vdc}$

$$R_{adj} = 5.11 \left( \frac{100}{4} - 2 \right) \text{k}\Omega = 117\text{ k}\Omega$$

PKM 4000C PINB series Direct Converters  
Input 36-75 V, Output up to 100 A / 204 W

EN/LZT 146 415 R5A Oct. 2017

© Flex

PKM 4218GC PINBHC

1.8V, 100A /180W Typical Characteristics

Output Current Derating – Open frame

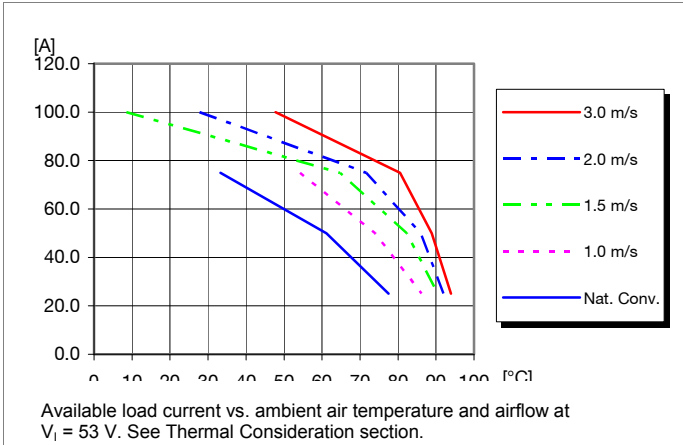

Output Current Derating – Base plate

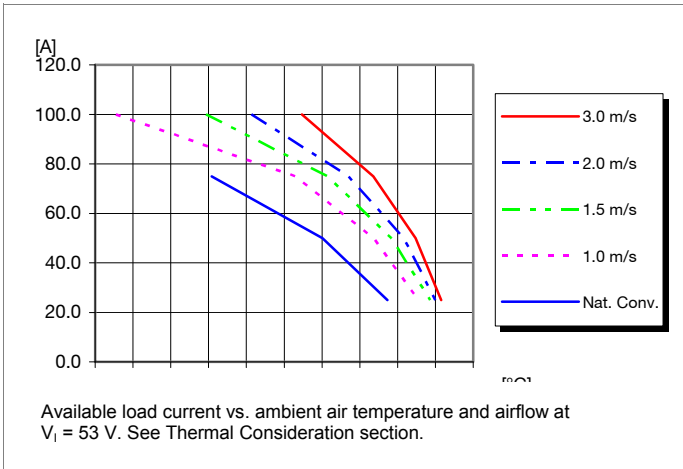

Thermal Resistance – Base plate

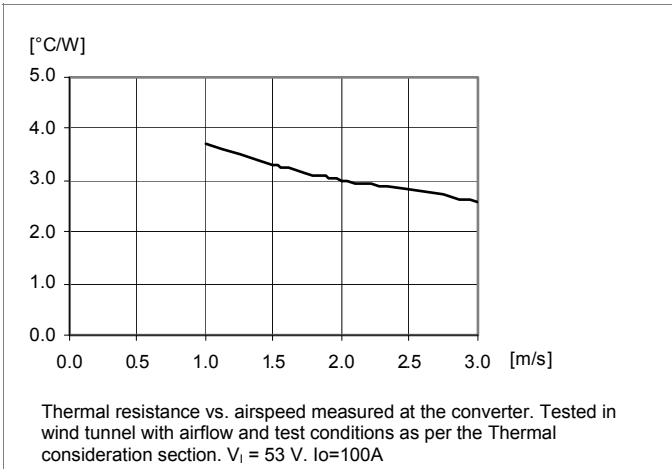

Output Current Derating – Cold wall sealed box

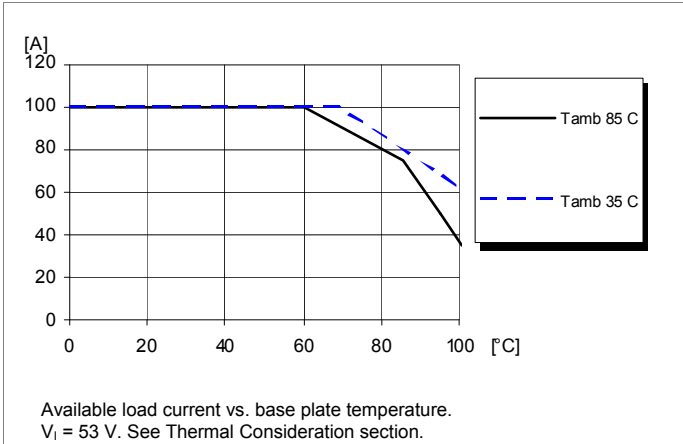

PKM 4000C PINB series Direct Converters  
Input 36-75 V, Output up to 100 A / 204 W

EN/LZT 146 415 R5A Oct. 2017

© Flex

### 3.3V, 50A /165W Electrical Specification

### PKM 4110C PINBHC

$T_{P1} = -40$  to  $+90^{\circ}\text{C}$ ,  $V_I = 36$  to  $75$  V, sense pins connected to output pins unless otherwise specified under Conditions.

Typical values given at:  $T_{P1} = +25^{\circ}\text{C}$ ,  $V_I = 53$  V, max  $I_O$ , unless otherwise specified under Conditions.

Additional  $C_{in} = 0$   $\mu\text{F}$ . See Operating Information section for selection of capacitor types.

Characteristics		Conditions	min	typ	max	Unit
$V_I$	Input voltage range		36		75	V
$V_{loff}$	Turn-off input voltage	Decreasing input voltage	30.0	32.0	33.5	V
$V_{lon}$	Turn-on input voltage	Increasing input voltage	32.0	34.0	35.5	V
$C_I$	Internal input capacitance			6.0		$\mu\text{F}$
$P_O$	Output power		0		165	W
$\eta$	Efficiency	50 % of max $I_O$		92.0		%
		max $I_O$		90.0		
		50 % of max $I_O$ , $V_I = 48$ V		92.1		
		max $I_O$ , $V_I = 48$ V		89.9		
$P_d$	Power Dissipation	max $I_O$		18.3	23.2	W
$P_{li}$	Input idling power	$I_O = 0$ A, $V_I = 53$ V		3.1		W
$P_{RC}$	Input standby power	$V_I = 53$ V (turned off with RC)		0.15		W
$f_s$	Switching frequency	0-100 % of max $I_O$	180	200	220	kHz

$V_{Oi}$	Output voltage initial setting and accuracy	$T_{P1} = +25^{\circ}\text{C}$ , $V_I = 53$ V, $I_O = 50$ A	3.24	3.30	3.36	V
$V_O$	Output adjust range	See operating information	2.97		3.63	V
	Output voltage tolerance band	0-100 % of max $I_O$	3.23		3.37	V
	Idling voltage	$I_O = 0$ A	3.23		3.37	V
	Line regulation	max $I_O$		2	11	mV
	Load regulation	$V_I = 53$ V, 0-100 % of max $I_O$		2	11	mV
$V_{tr}$	Load transient voltage deviation	$V_I = 53$ V, Load step 25-75-25 % of max $I_O$ , $di/dt = 5$ A/ $\mu\text{s}$ see Note 1		$\pm 320$	$\pm 400$	mV
$t_{tr}$	Load transient recovery time			35	100	$\mu\text{s}$
$t_r$	Ramp-up time (from 10-90 % of $V_{Oi}$ )	10-100 % of max $I_O$	1	3	6	ms
$t_s$	Start-up time (from $V_I$ connection to 90 % of $V_{Oi}$ )		9	15	20	ms
$t_f$	$V_I$ shut-down fall time (from $V_I$ off to 10 % of $V_O$ )	max $I_O$		0.08		ms
		$I_O = 0.5$ A		0.007		s
$t_{RC}$	RC start-up time	max $I_O$		15		ms
	RC shut-down fall time (from RC off to 10 % of $V_O$ )	max $I_O$		0.07		ms
		$I_O = 0.5$ A		0.006		s
$I_O$	Output current		0		50	A
$I_{lim}$	Current limit threshold	$T_{P1} < \text{max } T_{P1}$	53	65	83	A
$I_{sc}$	Short circuit current	$T_{P1} = 25^{\circ}\text{C}$ , see Note 2		11	17	A
$C_{out}$	Recommended Capacitive Load	$T_{P1} = 25^{\circ}\text{C}$ , see Note 3	0		5000	$\mu\text{F}$
$V_{Oac}$	Output ripple & noise	See ripple & noise section, max $I_O$ , $V_{Oi}$		70	120	mVp-p
OVP	Over voltage protection	$T_{P1} = +25^{\circ}\text{C}$ , $V_I = 53$ V, 0-100 % of max $I_O$	3.6	4.2 4.8		V

Note 1: 10 pieces of 470 $\mu\text{F}$  aluminium solid capacitors are connected to the module.

Note 2: Hic-cup mode, the value is in RMS, short circuit load is 7m ohm.

Note 3: Aluminium electrolytic capacitors, ESR is lower than 10m ohm.

PKM 4000C PINB series Direct Converters  
 Input 36-75 V, Output up to 100 A / 204 W

EN/LZT 146 415 R5A Oct. 2017

© Flex

**PKM 4110C PINBHC**

**3.3V, 50A /165W Typical Characteristics**

**Efficiency**

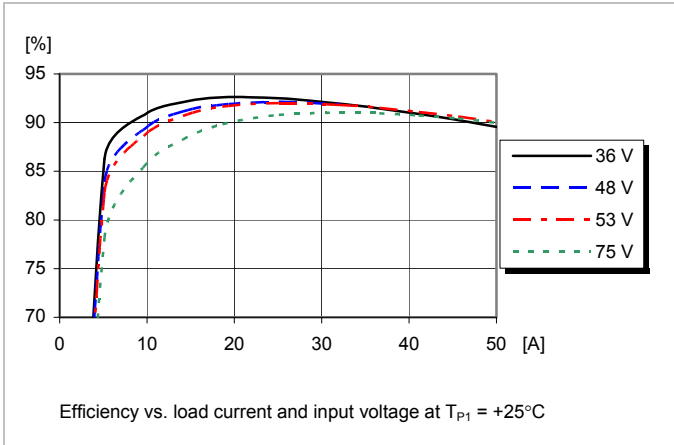

**Power Dissipation**

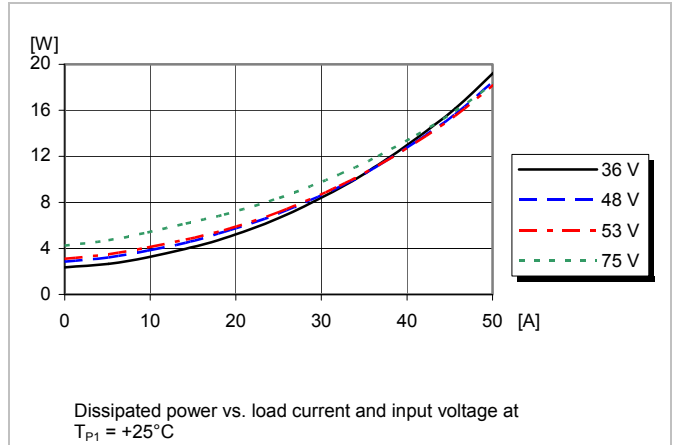

**Output Characteristics**

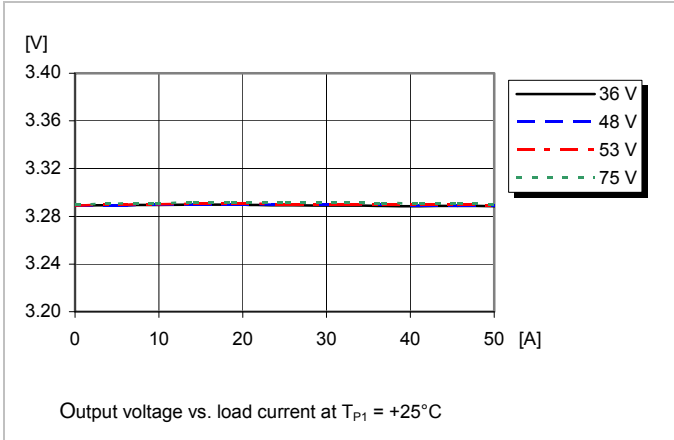

**Current Limit Characteristics**

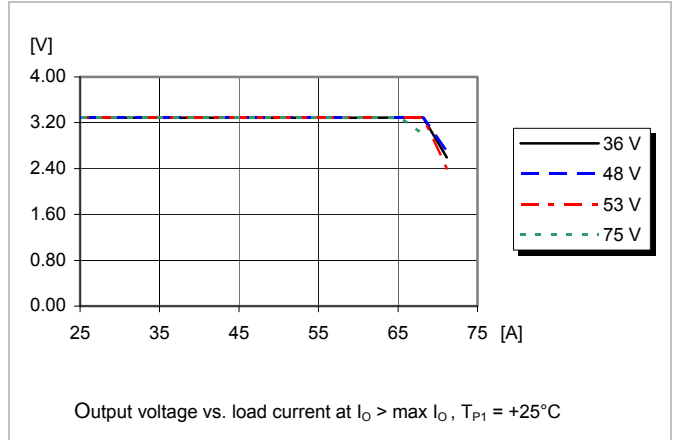

PKM 4000C PINB series Direct Converters  
 Input 36-75 V, Output up to 100 A / 204 W

EN/LZT 146 415 R5A Oct. 2017

© Flex

3.3V, 50A /165W Typical Characteristics

PKM 4110C PINBHC

Start-up

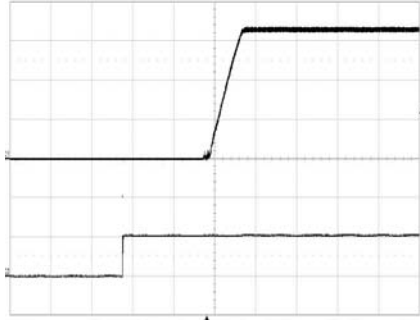

Start-up enabled by connecting  $V_i$  at:  
 $T_{P1} = +25^\circ\text{C}$ ,  $V_i = 53\text{ V}$ ,  
 $I_o = 50\text{ A}$  resistive load.

Top trace: output voltage 1.0 V/div.,  
 Bottom trace: input voltage (50 V/div.).  
 Time scale: (5 ms/div.).

Shut-down

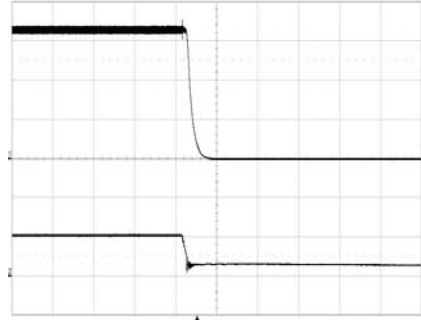

Shut-down enabled by disconnecting  $V_i$  at:  
 $T_{P1} = +25^\circ\text{C}$ ,  $V_i = 53\text{ V}$ ,  
 $I_o = 50\text{ A}$  resistive load.

Top trace: output voltage (1.0 V/div.),  
 Bottom trace: input voltage (50 V/div.).  
 Time scale: (0.2 ms/div.).

Output Ripple & Noise

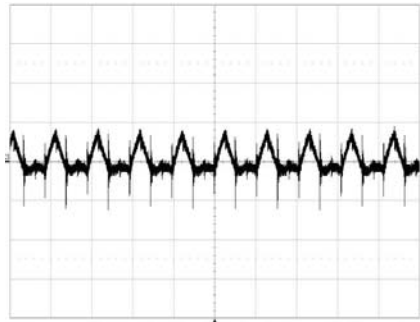

Output voltage ripple at:  
 $T_{P1} = +25^\circ\text{C}$ ,  $V_i = 53\text{ V}$ ,  
 $I_o = 50\text{ A}$  resistive load.

Trace: output voltage (50 mV/div.).  
 Time scale: (5 μs/div.).

Output Load Transient Response



Output voltage response to load current step-change (12.5-37.5-12.5 A) at:  
 $T_{P1} = +25^\circ\text{C}$ ,  $V_i = 53\text{ V}$ .

Top trace: output voltage (200 mV/div.).  
 Bottom trace: load current (20 A/div.).  
 Time scale: (0.2 ms/div.).

Output Voltage Adjust (see operating information)

Passive adjust

The resistor value for an adjusted output voltage is calculated by using the following equations:

Output Voltage Adjust Upwards, Increase:

$$R_{adj} = \left( \frac{5.11 \times 3.3(100 + \Delta\%)}{1.225 \times \Delta\%} - \frac{511}{\Delta\%} - 10.22 \right) \text{ k}\Omega$$

Example: Increase 4%  $\Rightarrow V_{out} = 3.43\text{ Vdc}$

$$\left( \frac{5.11 \times 3.3(100 + 4)}{1.225 \times 4} - \frac{511}{4} - 10.22 \right) \text{ k}\Omega = 219.9 \text{ k}\Omega$$

Output Voltage Adjust Downwards, Increase:

$$R_{adj} = 5.11 \left( \frac{100}{\Delta\%} - 2 \right) \text{ k}\Omega$$

Example: Decrease 2%  $\Rightarrow V_{out} = 3.23\text{ Vdc}$

$\text{k}\Omega = 404.32 \text{ k}\Omega$

$$5.11 \left( \frac{100}{2} - 2 \right) \text{ k}\Omega = 245.3 \text{ k}\Omega$$

PKM 4000C PINB series Direct Converters  
Input 36-75 V, Output up to 100 A / 204 W

EN/LZT 146 415 R5A Oct. 2017

© Flex

3.3V, 50A /165W Typical Characteristics

PKM 4110C PINBHC

Output Current Derating – Open frame

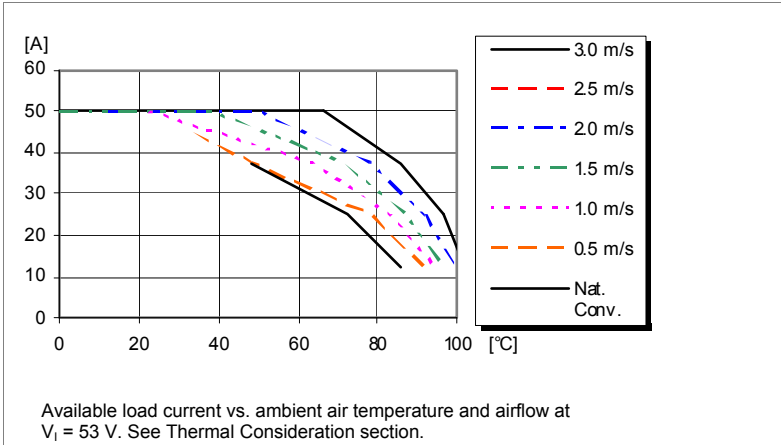

Output Current Derating – Base plate

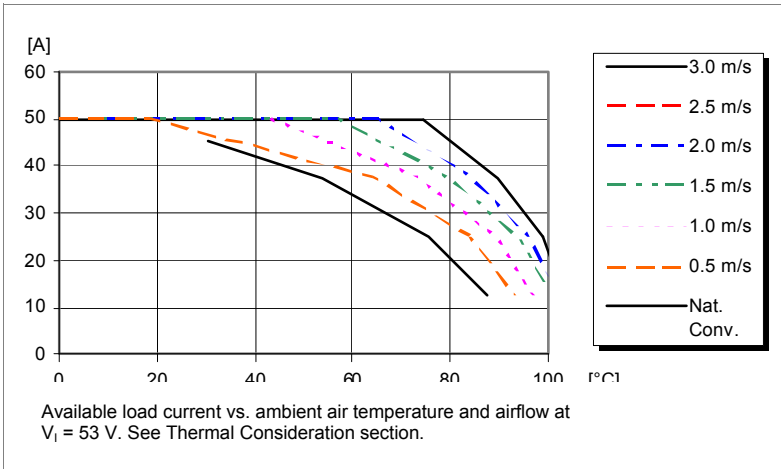

Thermal Resistance – Base plate

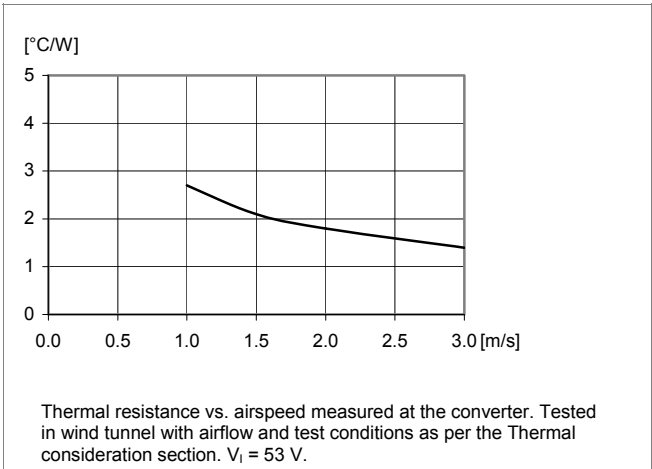

Output Current Derating – Cold wall sealed box

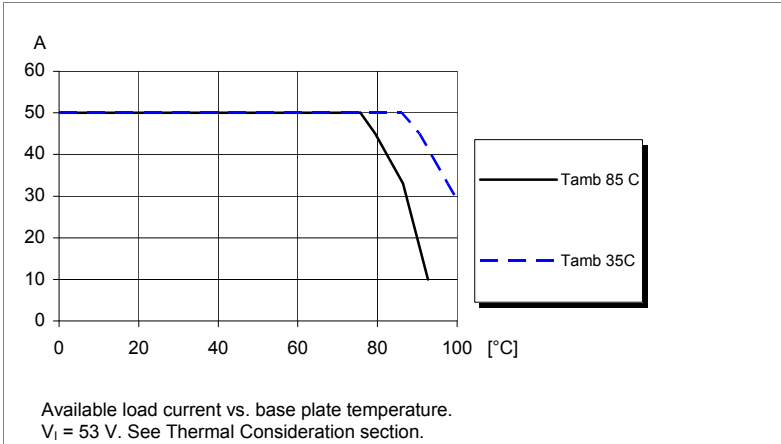



PKM 4000C PINB series Direct Converters  
 Input 36-75 V, Output up to 100 A / 204 W

EN/LZT 146 415 R5A Oct. 2017

© Flex

**5.0V, 40A/200W Electrical Specification**

**PKM 4211C PINBHC**

$T_{P1} = -40$  to  $+90^{\circ}\text{C}$ ,  $V_I = 36$  to  $75$  V, sense pins connected to output pins unless otherwise specified under Conditions.

Typical values given at:  $T_{P1} = +25^{\circ}\text{C}$ ,  $V_I = 53$  V, max  $I_O$ , unless otherwise specified under Conditions.

Additional  $C_{in} = 0$   $\mu\text{F}$ . See Operating Information section for selection of capacitor types.

Characteristics		Conditions	min	typ	max	Unit
$V_I$	Input voltage range		36		75	V
$V_{loff}$	Turn-off input voltage	Decreasing input voltage	30.0	32.0	33.5	V
$V_{lon}$	Turn-on input voltage	Increasing input voltage	32.0	34.0	35.5	V
$C_I$	Internal input capacitance			6.0		$\mu\text{F}$
$P_O$	Output power		0		200	W
$\eta$	Efficiency	50 % of max $I_O$		92.3		%
		max $I_O$		90.1		
		50 % of max $I_O$ , $V_I = 48$ V		92.5		
		max $I_O$ , $V_I = 48$ V		90.0		
$P_d$	Power Dissipation	max $I_O$		21.9	28.9	W
$P_{li}$	Input idling power	$I_O = 0$ A, $V_I = 53$ V		3.2		W
$P_{RC}$	Input standby power	$V_I = 53$ V (turned off with RC)		0.05		W
$f_s$	Switching frequency	0-100 % of max $I_O$	180	200	220	kHz

$V_{Oi}$	Output voltage initial setting and accuracy	$T_{P1} = +25^{\circ}\text{C}$ , $V_I = 53$ V, $I_O = 40$ A	4.90	5.00	5.10	V
$V_O$	Output adjust range	See operating information	4.50		5.50	V
	Output voltage tolerance band	0-100 % of max $I_O$	4.80		5.20	V
	Idling voltage	$I_O = 0$ A	4.80		5.20	V
	Line regulation	max $I_O$		2	10	mV
	Load regulation	$V_I = 53$ V, 0-100 % of max $I_O$		3	10	mV
$V_{tr}$	Load transient voltage deviation	$V_I = 53$ V, Load step 25-75-25 % of max $I_O$ , $di/dt = 5\text{A}/\mu\text{s}$ , see Note 1		$\pm 350$	$\pm 700$	mV
$t_{tr}$	Load transient recovery time			50	100	$\mu\text{s}$
$t_r$	Ramp-up time (from 10-90 % of $V_{Oi}$ )	10-100 % of max $I_O$	1	3	15	ms
$t_s$	Start-up time (from $V_I$ connection to 90 % of $V_{Oi}$ )		7	15	30	ms
$t_f$	$V_I$ shut-down fall time (from $V_I$ off to 10 % of $V_O$ )	max $I_O$		0.1		ms
		$I_O = 0.4$ A		0.01		s
$t_{RC}$	RC start-up time	max $I_O$		13		ms
	RC shut-down fall time (from RC off to 10 % of $V_O$ )	max $I_O$		0.1		ms
		$I_O = 0.4$ A		0.01		s
$I_O$	Output current		0		40	A
$I_{lim}$	Current limit threshold	$T_{P1} < \text{max } T_{P1}$	43	53	63	A
$I_{sc}$	Short circuit current	$T_{P1} = 25^{\circ}\text{C}$ , see Note 2		13		A
$C_{out}$	Recommended Capacitive Load	$T_{P1} = 25^{\circ}\text{C}$ , see Note 3	0		4000	$\mu\text{F}$
$V_{Oac}$	Output ripple & noise	See ripple & noise section, max $I_O$ , $V_{Oi}$		70	150	mVp-p
OVP	Over voltage protection	$T_{P1} = +25^{\circ}\text{C}$ , $V_I = 53$ V, 0-100 % of max $I_O$	6.2	6.8 7.2		V

Note 1: 9 pieces of 470uF aluminium solid capacitors are connected to the module.

Note 2: Hic-cup mode, the value is in RMS, short circuit load is 5mohm.

Note 3: Aluminium electrolytic capacitors, ESR is lower than 10 mohm.

PKM 4000C PINB series Direct Converters  
 Input 36-75 V, Output up to 100 A / 204 W

EN/LZT 146 415 R5A Oct. 2017

© Flex

5.0V, 40A /200W Typical Characteristics

PKM 4211C PINBHC

Efficiency

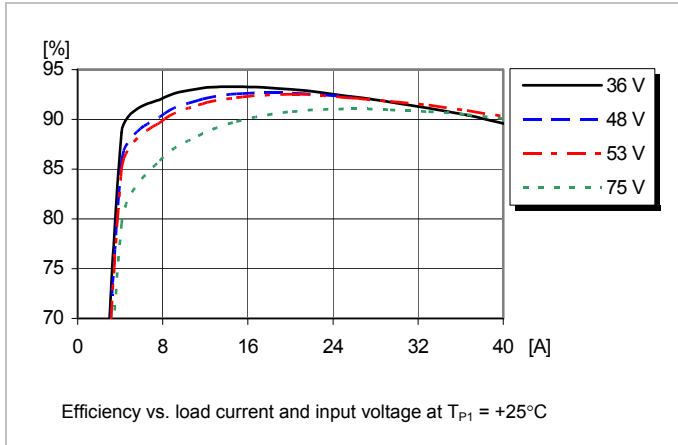

Power Dissipation

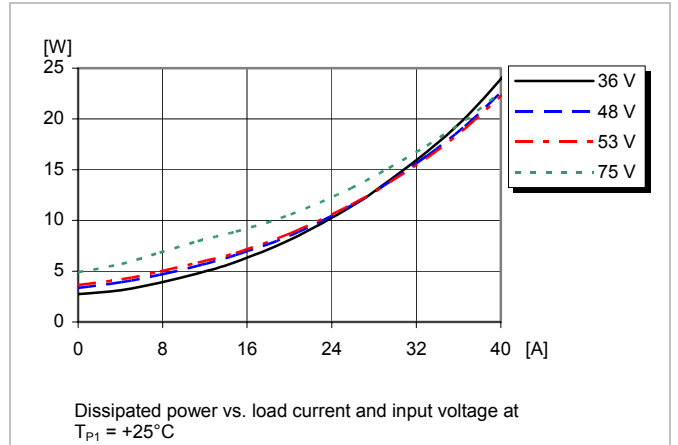

Output Characteristics

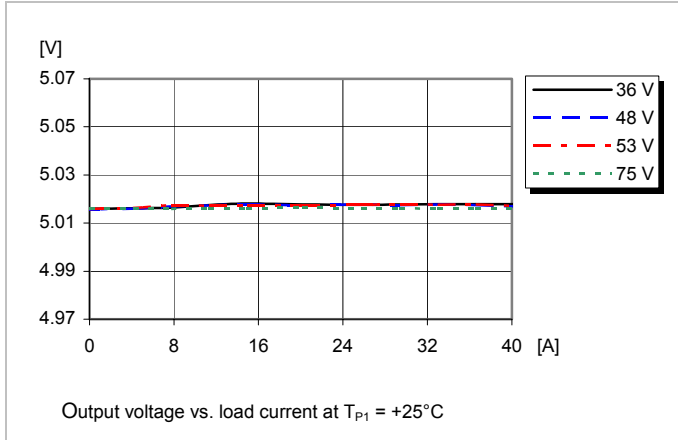

Current Limit Characteristics

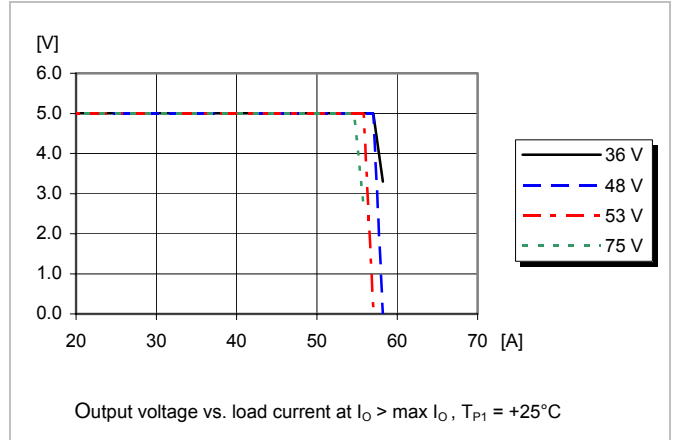

5.0V, 40A /200W Typical Characteristics

PKM 4211C PINBHC

Start-up

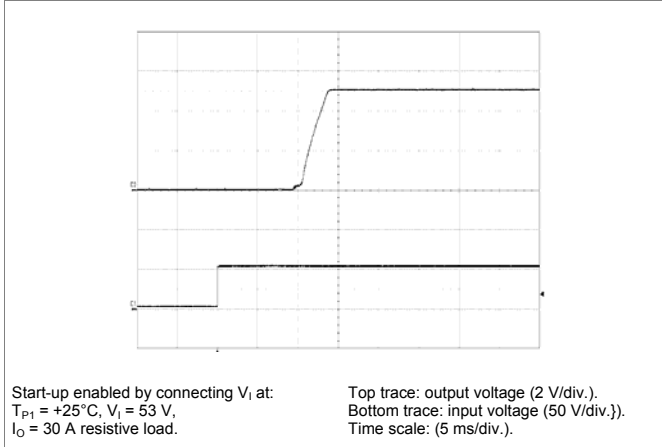

Shut-down

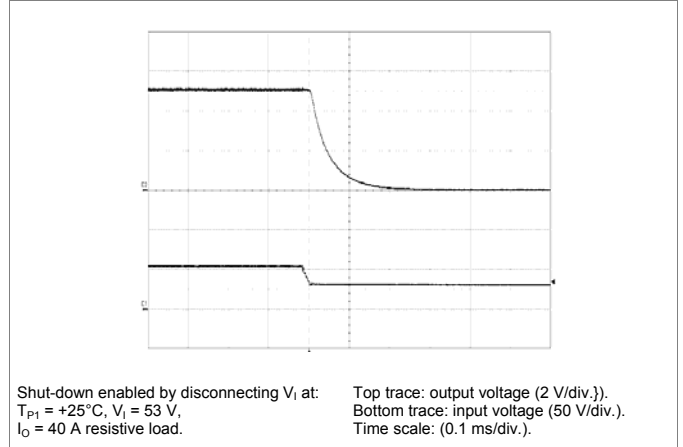

Output Ripple & Noise

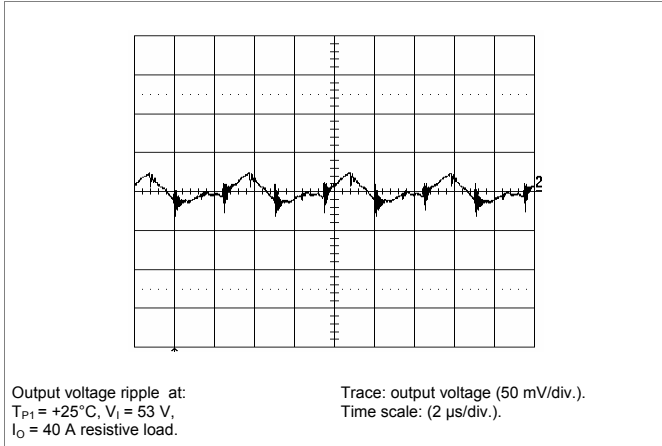

Output Load Transient Response

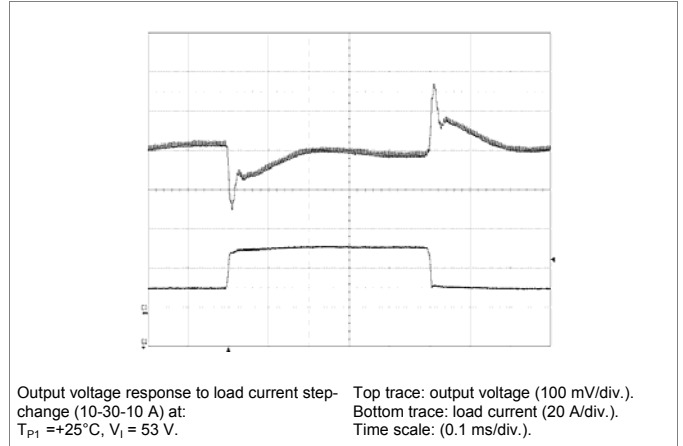

Output Voltage Adjust (see operating information)

Passive adjust

The resistor value for an adjusted output voltage is calculated by using the following equations:

Output Voltage Adjust Upwards, Increase:

$$R_{adj} = \left( \frac{5.11 \times 5.0(100 + \Delta\%)}{1.225 \times \Delta\%} - \frac{511}{\Delta\%} - 10.22 \right) \text{ k}\Omega$$

Example: Increase 4%  $\Rightarrow V_{out} = 5.20\text{ Vdc}$

$$\left( \frac{5.11 \times 5.0(100 + 4)}{1.225 \times 4} - \frac{511}{4} - 10.22 \right) \text{ k}\Omega = 404.3 \text{ k}\Omega$$

Output Voltage Adjust Downwards, Increase:

$$R_{adj} = 5.11 \left( \frac{100}{\Delta\%} - 2 \right) \text{ k}\Omega$$

Example: Decrease 2%  $\Rightarrow V_{out} = 4.90\text{ Vdc}$

$\text{k}\Omega = 404.32 \text{ k}\Omega$

$$5.11 \left( \frac{100}{2} - 2 \right) \text{ k}\Omega = 245.3 \text{ k}\Omega$$

PKM 4000C PINB series Direct Converters  
 Input 36-75 V, Output up to 100 A / 204 W

EN/LZT 146 415 R5A Oct. 2017

© Flex

PKM 4211C PINBHC

5.0V, 40A /200W Typical Characteristics

Output Current Derating – Open frame

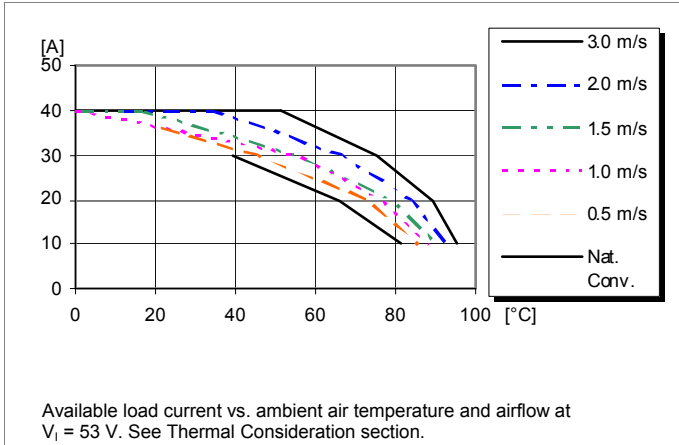

Output Current Derating – Base plate

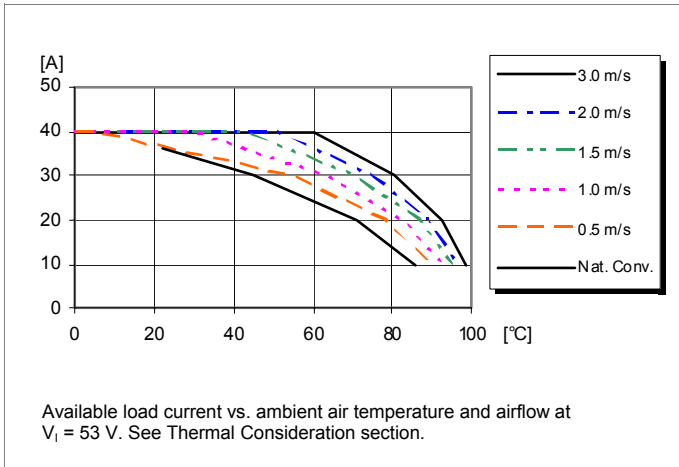

Thermal Resistance – Base plate

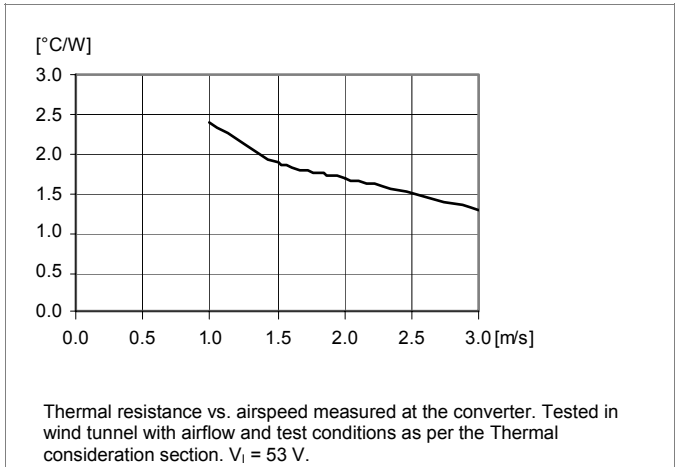

Output Current Derating – Cold wall sealed box

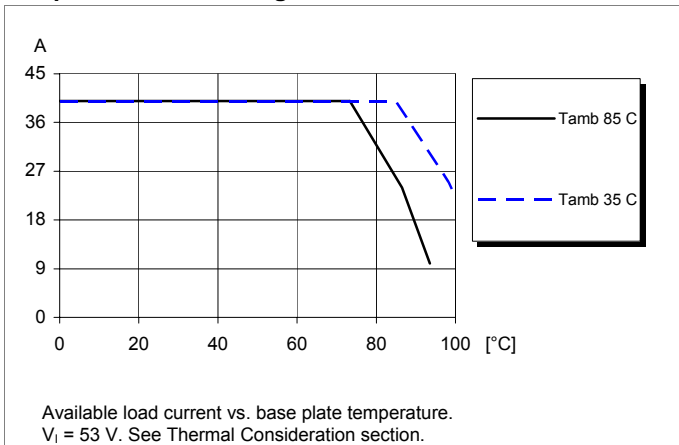

PKM 4000C PINB series Direct Converters  
 Input 36-75 V, Output up to 100 A / 204 W

EN/LZT 146 415 R5A Oct. 2017

© Flex

**12V, 17A/204W Electrical Specification**

**PKM 4213C PINBH CSP**

$T_{P1} = -40$  to  $+90^{\circ}\text{C}$ ,  $V_I = 38$  to  $75$  V, sense pins connected to output pins unless otherwise specified under Conditions.

Typical values given at:  $T_{P1} = +25^{\circ}\text{C}$ ,  $V_I = 53$  V, max  $I_O$ , unless otherwise specified under Conditions.

Additional  $C_{in} = 0$   $\mu\text{F}$ . See Operating Information section for selection of capacitor types.

Characteristics		Conditions	min	typ	max	Unit
$V_I$	Input voltage range		38		75	V
$V_{loff}$	Turn-off input voltage	Decreasing input voltage	30	31	32	V
$V_{lon}$	Turn-on input voltage	Increasing input voltage	32	33	34	V
$C_I$	Internal input capacitance			6.0		$\mu\text{F}$
$P_O$	Output power		0		204	W
$\eta$	Efficiency	50 % of max $I_O$		94.3		%
		max $I_O$		93.4		
		50 % of max $I_O$ , $V_I = 48$ V		94.4		
		max $I_O$ , $V_I = 48$ V		93.3		
$P_d$	Power Dissipation	max $I_O$		14.4	18.3	W
$P_{li}$	Input idling power	$I_O = 0$ A, $V_I = 53$ V		2.6		W
$P_{RC}$	Input standby power	$V_I = 53$ V (turned off with RC)		0.09		W
$f_s$	Switching frequency	0-100 % of max $I_O$	180	200	220	kHz

$V_{Oi}$	Output voltage initial setting and accuracy	$T_{P1} = +25^{\circ}\text{C}$ , $V_I = 53$ V, $I_O = 40$ A	11.8	12	12.2	V
$V_O$	Output adjust range	See operating information	10.8		13.2	V
	Output voltage tolerance band	0-100 % of max $I_O$	11.7		12.3	V
	Idling voltage	$I_O = 0$ A	11.8		12.2	V
	Line regulation	max $I_O$		10	20	mV
	Load regulation	$V_I = 53$ V, 0-100 % of max $I_O$		10	20	mV
$V_{tr}$	Load transient voltage deviation	$V_I = 53$ V, Load step 25-75-25 % of max $I_O$ , $di/dt = 5\text{A}/\mu\text{s}$ , see Note 1		$\pm 300$	$\pm 450$	mV
$t_{tr}$	Load transient recovery time			51	170	$\mu\text{s}$
$t_r$	Ramp-up time (from 10-90 % of $V_{Oi}$ )	10-100 % of max $I_O$	1.9	3	5	ms
$t_s$	Start-up time (from $V_I$ connection to 90 % of $V_{Oi}$ )		9	15	20	ms
$t_f$	$V_I$ shut-down fall time (from $V_I$ off to 10 % of $V_O$ )	max $I_O$		0.3		ms
		$I_O = 0$ A		9.5		s
$t_{RC}$	RC start-up time	max $I_O$		15		ms
	RC shut-down fall time (from RC off to 10 % of $V_O$ )	max $I_O$		0.3		ms
		$I_O = 0$ A		10		s
$I_O$	Output current		0		17	A
$I_{lim}$	Current limit threshold	$T_{P1} < \text{max } T_{P1}$	19	25	30	A
$I_{sc}$	Short circuit current	$T_{P1} = 25^{\circ}\text{C}$ , see Note 2		10		A
$C_{out}$	Recommended Capacitive Load	$T_{P1} = 25^{\circ}\text{C}$ , see Note 3	0		1700	$\mu\text{F}$
$V_{Oac}$	Output ripple & noise	See ripple & noise section, max $I_O$ , $V_{Oi}$		100	150	mVp-p
OVP	Over voltage protection	$T_{P1} = +25^{\circ}\text{C}$ , $V_I = 53$ V, 0-100 % of max $I_O$		14.3		V

Note 1: 1700 $\mu\text{F}$  aluminium solid capacitors are connected to the module.

Note 2: Hic-cup mode, the value is in RMS, short circuit load is 5mohm.

Note 3: Aluminium electrolytic capacitors, ESR is lower than 10 mohm.

PKM 4000C PINB series Direct Converters  
 Input 36-75 V, Output up to 100 A / 204 W

EN/LZT 146 415 R5A Oct. 2017

© Flex

12V, 17A /204W Typical Characteristics

PKM 4213C PINBH CSP

Efficiency

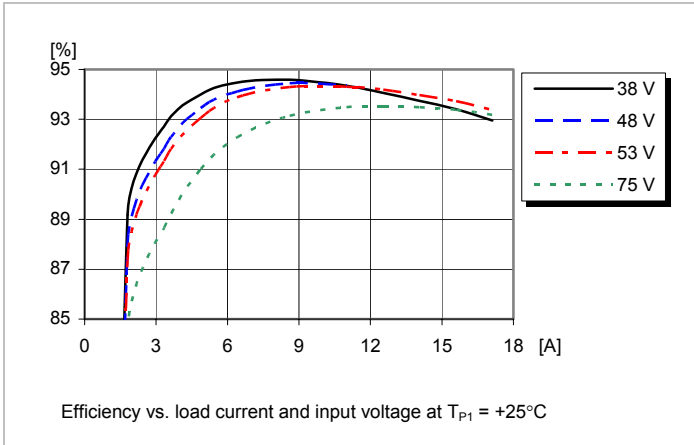

Power Dissipation

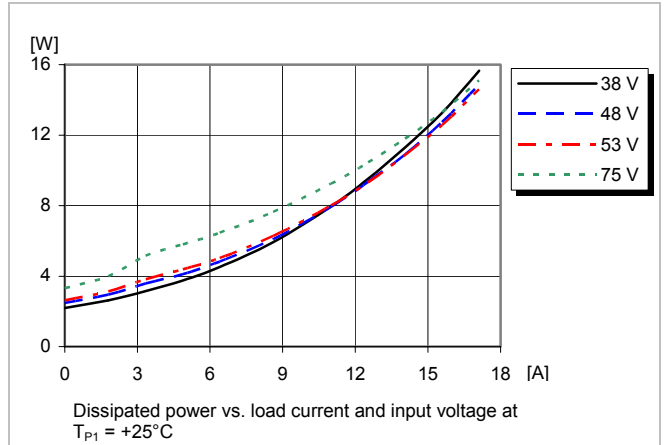

Output Characteristics

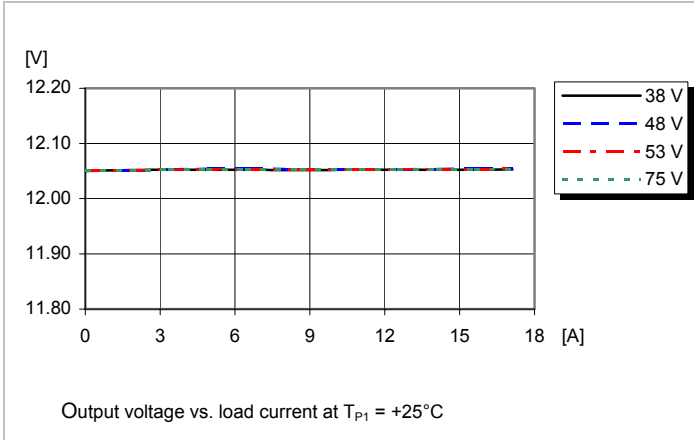

Current Limit Characteristics

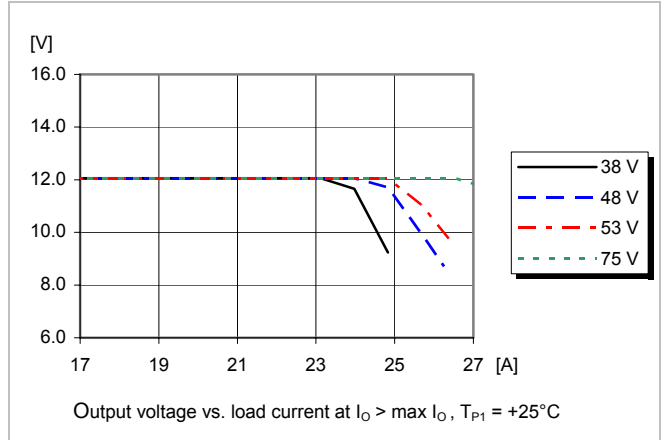

PKM 4000C PINB series Direct Converters  
 Input 36-75 V, Output up to 100 A / 204 W

EN/LZT 146 415 R5A Oct. 2017

© Flex

12V, 17A /204W Typical Characteristics

PKM 4213C PINBH CSP

Start-up

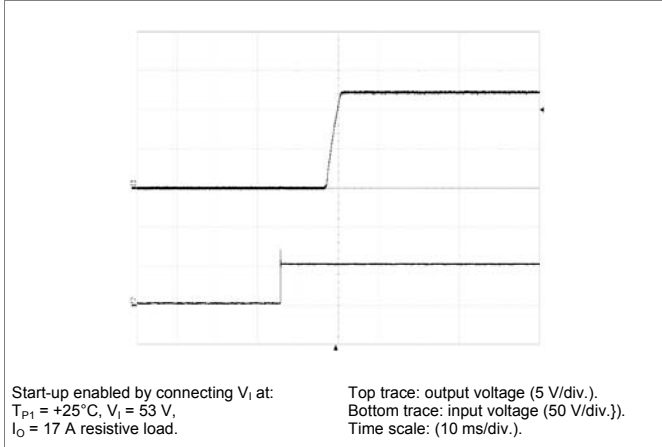

Shut-down

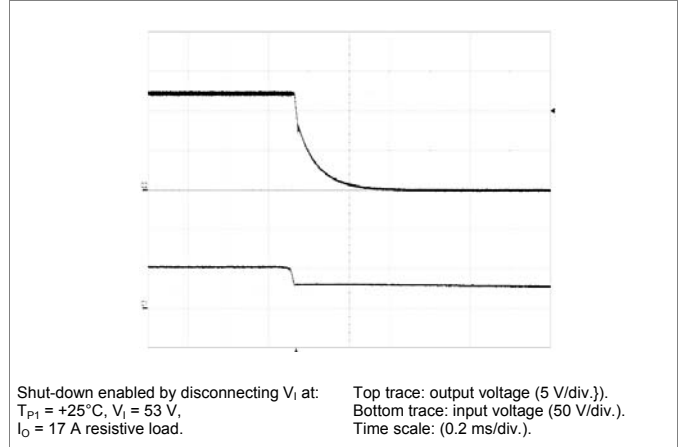

Output Ripple & Noise

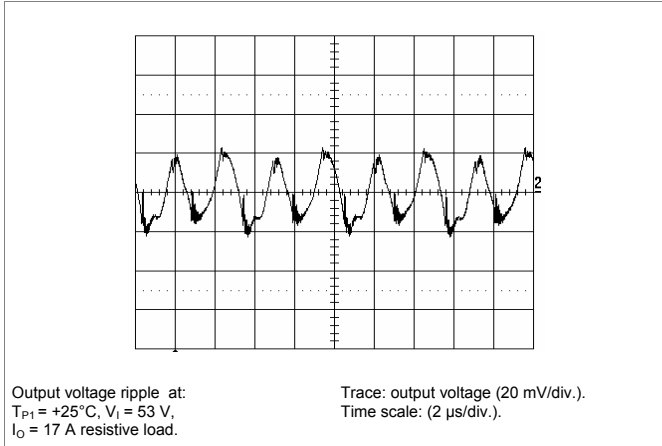

Output Load Transient Response

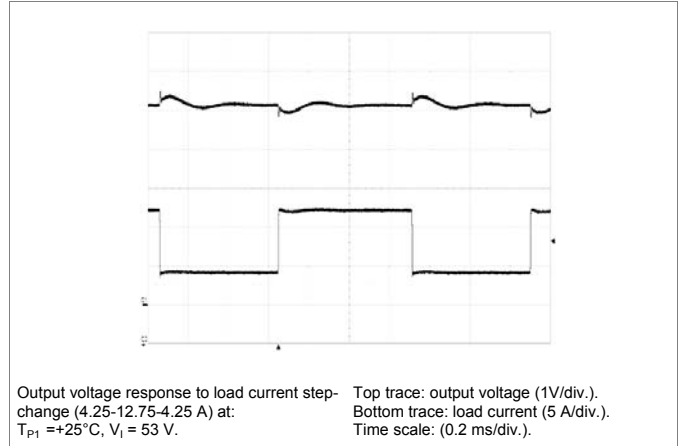

Output Voltage Adjust (see operating information)

Passive adjust

The resistor value for an adjusted output voltage is calculated by using the following equations:

Output Voltage Adjust Upwards, Increase:

$$R_{adj} = \left( \frac{5.11 \times 12 \times (100 + \Delta\%)}{1.225 \times \Delta\%} - \frac{511}{\Delta\%} - 10.22 \right) \text{ k}\Omega$$

Example: Increase 4% =>  $V_{out} = 12.48\text{ Vdc}$

$$\left( \frac{5.11 \times 12 \times (100 + 4)}{1.225 \times 4} - \frac{511}{4} - 10.22 \right) \text{ k}\Omega = 1163.5 \text{ k}\Omega$$

Output Voltage Adjust Downwards, Increase:

$$R_{adj} = 5.11 \left( \frac{100}{\Delta\%} - 2 \right) \text{ k}\Omega$$

Example: Decrease 2% =>  $V_{out} = 11.76\text{ Vdc}$

$$5.11 \left( \frac{100}{2} - 2 \right) \text{ k}\Omega = 245.3 \text{ k}\Omega$$

PKM 4000C PINB series Direct Converters  
 Input 36-75 V, Output up to 100 A / 204 W

EN/LZT 146 415 R5A Oct. 2017

© Flex

12V, 17A /204W Typical Characteristics

PKM 4213C PINBHCSP

Output Current Derating – Open frame

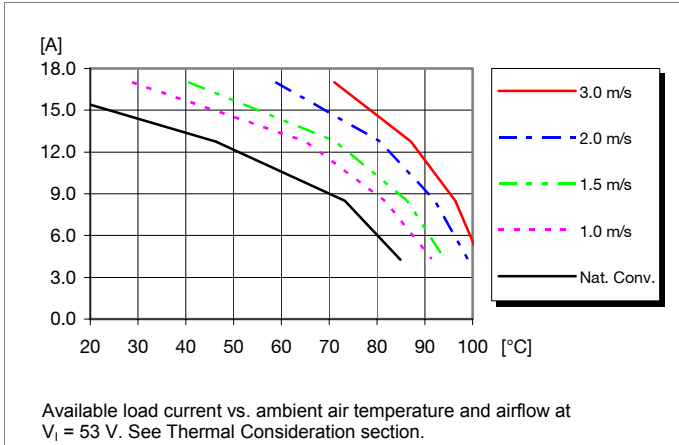

Output Current Derating – Base plate

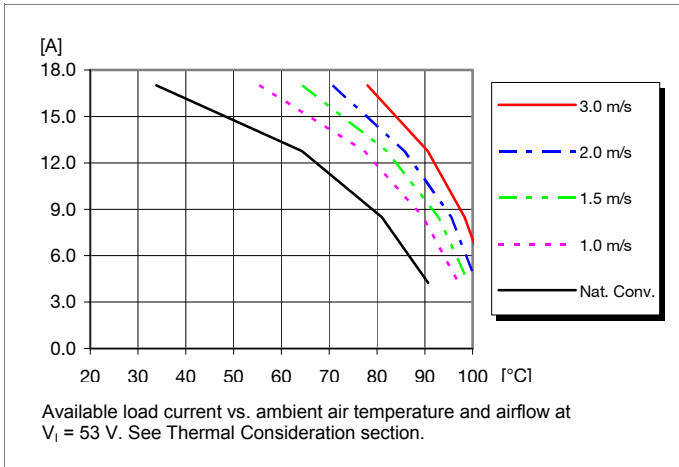

Thermal Resistance – Base plate

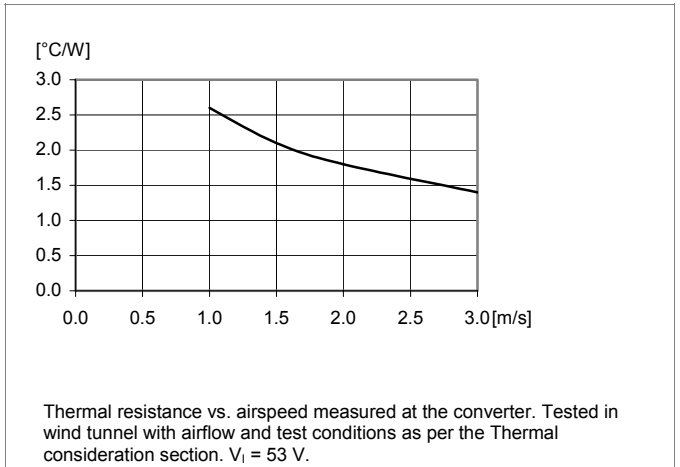

Output Current Derating – Cold wall sealed box

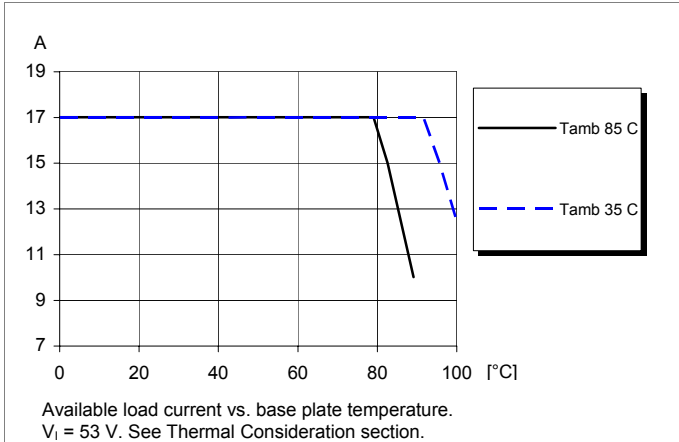



PKM 4000C PINB series Direct Converters  
Input 36-75 V, Output up to 100 A / 204 W

EN/LZT 146 415 R5A Oct. 2017

© Flex

### EMC Specification

Conducted EMI measured according to EN55022, CISPR 22 and FCC part 15J (see test set-up). See Design Note 009 for further information. The fundamental switching frequency is 200 kHz for PKM 4211C PINBHC HC @  $V_I = 53$  V, max  $I_o$ .

### Conducted EMI Input terminal value (typ)

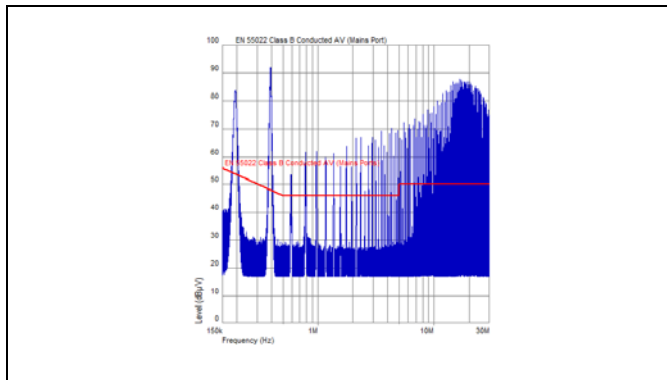

EMI without filter

### External filter (class B)

Required external input filter in order to meet class B in EN 55022, CISPR 22 and FCC part 15J.

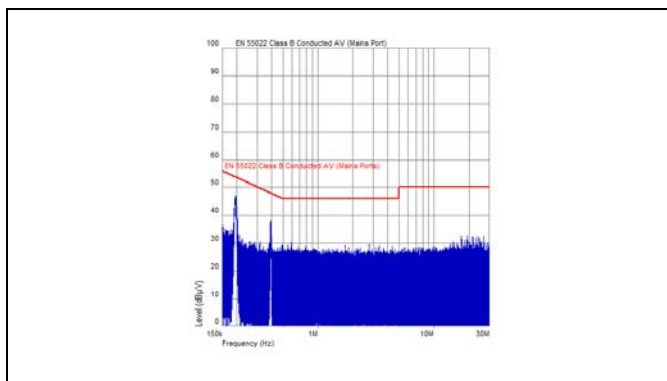
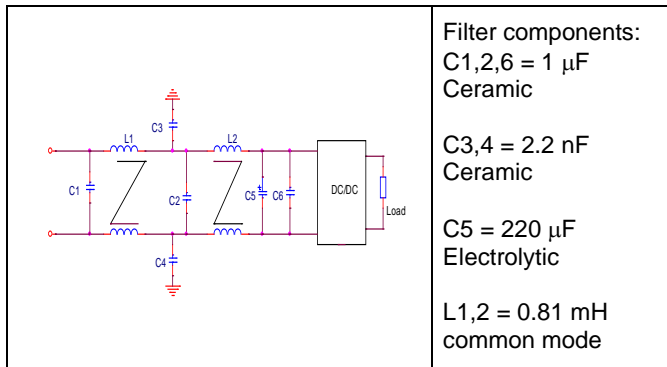

EMI with filter

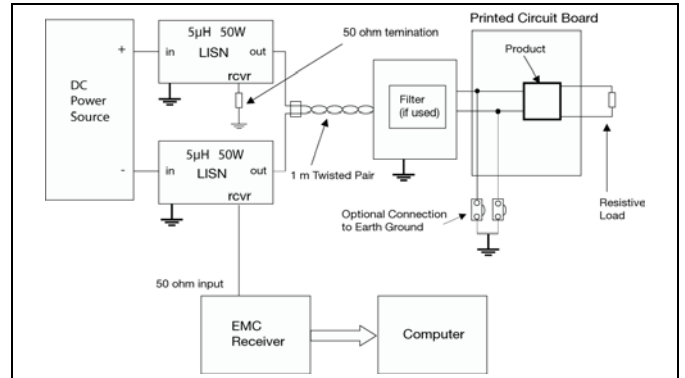

Test set-up

### Layout recommendations

The radiated EMI performance of the Product will depend on the PCB layout and ground layer design. It is also important to consider the stand-off of the product. If a ground layer is used, it should be connected to the output of the product and the equipment ground or chassis.

A ground layer will increase the stray capacitance in the PCB and improve the high frequency EMC performance.

### Output ripple and noise

Output ripple and noise measured according to figure below. See Design Note 022 for detailed information.

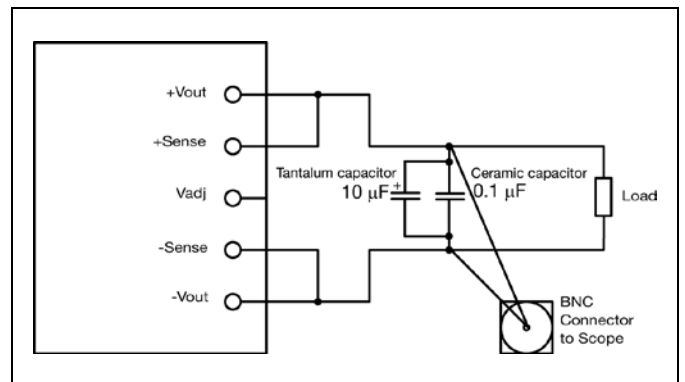

Output ripple and noise test setup

PKM 4000C PINB series Direct Converters Input 36-75 V, Output up to 100 A / 204 W	EN/LZT 146 415 R5A Oct. 2017
	© Flex

## Operating information

### Input Voltage

The input voltage range 36 to 75Vdc meets the requirements of the European Telecom Standard ETS 300 132-2 for normal input voltage range in -48 and -60 Vdc systems, -40.5 to -57.0 V and -50.0 to -72 V respectively.

At input voltages exceeding 75 V, the power loss will be higher than at normal input voltage and  $T_{P1}$  must be limited to absolute max +110°C. The absolute maximum continuous input voltage is 80 Vdc.

### Turn-off Input Voltage

The products monitor the input voltage and will turn on and turn off at predetermined levels.

The minimum hysteresis between turn on and turn off input voltage is 1V.

### Remote Control (RC)

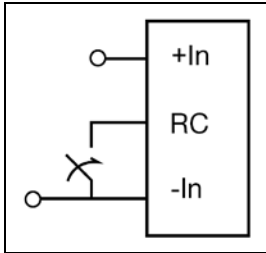

The products are fitted with a remote control function referenced to the primary negative input connection (-In), with negative and positive logic options available. The RC function allows the product to be turned on/off by an external device like a semiconductor or mechanical switch.

The maximum required sink current is 1 mA. When the RC pin is left open, the voltage generated on the RC pin is 5.0 – 7.0 V. The standard product is provided with “negative logic” remote control and will be off until the RC pin is connected to the -In. To turn on the product the voltage between RC pin and -In should be less than 1V. To turn off the converter the RC pin should be left open, or connected to a voltage higher than 13 V referenced to -In. In situations where it is desired to have the product to power up automatically without the need for control signals or a switch, the RC pin can be wired directly to -In.

The second option is “positive logic” remote control, which can be ordered by adding the suffix “P” to the end of the part number. When the RC pin is left open, the product starts up automatically when the input voltage is applied. Turn off is achieved by connecting the RC pin to the -In. To ensure safe turn off the voltage difference between RC pin and the -In pin shall be less than 1V. The product will restart automatically when this connection is opened.

See Design Note 021 for detailed information.

### Input and Output Impedance

The impedance of both the input source and the load will interact with the impedance of the product. It is important that the input source has low characteristic impedance. The products are designed for stable operation without external capacitors connected to the input or output. The performance

in some applications can be enhanced by addition of external capacitance as described under External Decoupling Capacitors.

If the input voltage source contains significant inductance, the addition of a 22 - 100  $\mu$ F capacitor across the input of the product will ensure stable operation. The capacitor is not required when powering the product from an input source with an inductance below 10  $\mu$ H. The minimum required capacitance value depends on the output power and the input voltage. The higher output power the higher input capacitance is needed. Approximately doubled capacitance value is required for a 24 V input voltage source compared to a 48V input voltage source.

### External Decoupling Capacitors

When powering loads with significant dynamic current requirements, the voltage regulation at the point of load can be improved by addition of decoupling capacitors at the load. The most effective technique is to locate low ESR ceramic and electrolytic capacitors as close to the load as possible, using several parallel capacitors to lower the effective ESR. The ceramic capacitors will handle high-frequency dynamic load changes while the electrolytic capacitors are used to handle low frequency dynamic load changes. It is equally important to use low resistance and low inductance PCB layouts and cabling.

External decoupling capacitors will become part of the product’s control loop. The control loop is optimized for a wide range of external capacitance and the maximum recommended value that could be used without any additional analysis is found in the Electrical specification.

The ESR of the capacitors is a very important parameter. Stable operation is guaranteed with a verified ESR value of >5 m $\Omega$  across the output connections.

For further information please contact your local Flex representative.

### Output Voltage Adjust ( $V_{adj}$ )

The products have an Output Voltage Adjust pin ( $V_{adj}$ ). This pin can be used to adjust the output voltage above or below Output voltage initial setting.

When increasing the output voltage, the voltage at the output pins (including any remote sense compensation ) must be kept below the threshold of the over voltage protection, (OVP) to prevent the product from shutting down. At increased output voltages the maximum power rating of the product remains the same, and the max output current must be decreased correspondingly.

To increase the voltage the resistor should be connected between the  $V_{adj}$  pin and +Sense pin. The resistor value of the Output voltage adjust function is according to information given under the Output section for the respective product.

To decrease the output voltage, the resistor should be connected between the  $V_{adj}$  pin and -Sense pin.

PKM 4000C PINB series Direct Converters  
 Input 36-75 V, Output up to 100 A / 204 W

EN/LZT 146 415 R5A Oct. 2017

© Flex

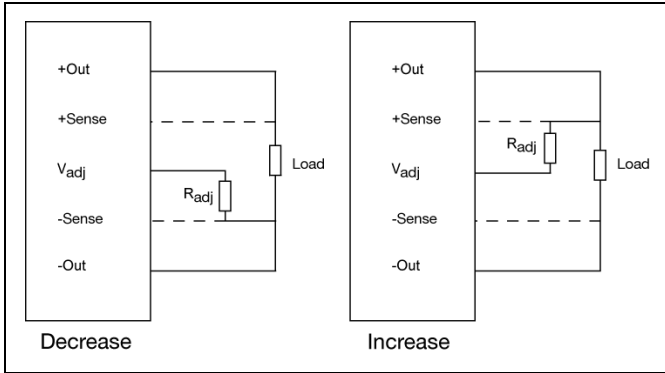

During hiccup, the module will try to restart and shutdown again for the overload. When the overload is removed, the products will continue to work normally.

**Thermal Consideration**

**General**

The products are designed to operate in different thermal environments and sufficient cooling must be provided to ensure reliable operation.

For products mounted on a PCB without a heat sink attached, cooling is achieved mainly by conduction, from the pins to the host board, and convection, which is dependant on the airflow across the product. Increased airflow enhances the cooling of the product. The Output Current Derating graph found in the Output section for each model provides the available output current vs. ambient air temperature and air velocity at  $V_1 = 53 \text{ V}$ .

The product is tested on a 254 x 254 mm, 35  $\mu\text{m}$  (1 oz), 16-layer test board mounted vertically in a wind tunnel with a cross-section of 608 x 203 mm.

**Parallel Operation**

Two products may be paralleled for redundancy if the total power is equal or less than  $P_O \text{ max}$ . It is not recommended to parallel the products without using external current sharing circuits.

See Design Note 006 for detailed information.

**Remote Sense**

The products have remote sense that can be used to compensate for voltage drops between the output and the point of load. The sense traces should be located close to the PCB ground layer to reduce noise susceptibility. The remote sense circuitry will compensate for up to 10% voltage drop between output pins and the point of load.

If the remote sense is not needed +Sense should be connected to +Out and -Sense should be connected to -Out.

**Over Temperature Protection (OTP)**

The products are protected from thermal overload by an internal over temperature shutdown circuit. When  $T_{P1}$  as defined in thermal consideration section exceeds 135°C the product will shut down. The product will make continuous attempts to start up (non-latching mode) and resume normal operation automatically when the temperature has dropped >15°C below the temperature threshold.

**Over Voltage Protection (OVP)**

The products have output over voltage protection that will shut down the product in over voltage conditions. The product will make continuous attempts to start up (non-latching mode) and resume normal operation automatically after removal of the over voltage condition.

**Over Current Protection (OCP)**

The products include current limiting circuitry for protection at continuous overload. The output voltage will decrease when the output current in excess of its current limit point, when the load continue to increase to some higher level, the module will enter into hiccup mode.

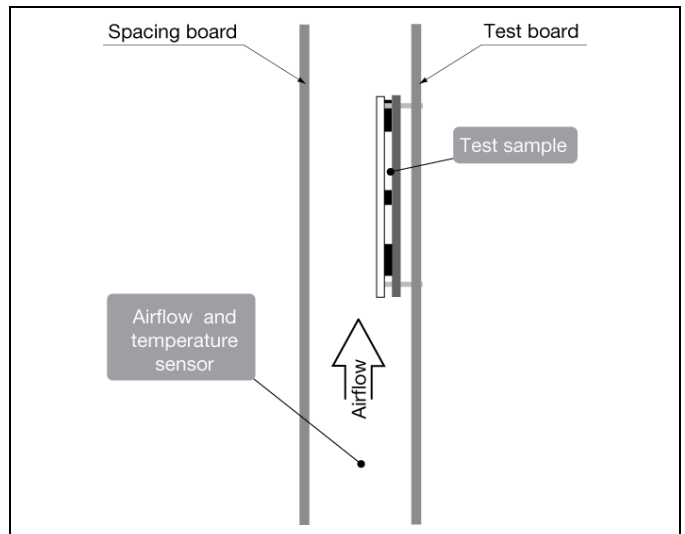

For products with base plate used in a sealed box/cold wall application, cooling is achieved mainly by conduction through the cold wall. The Output Current Derating graphs are found in the Output section for each module. The product is tested in a sealed box test set up with ambient temperatures 85 and 35°C. See Design Note 028 for further details.

PKM 4000C PINB series Direct Converters  
 Input 36-75 V, Output up to 100 A / 204 W

EN/LZT 146 415 R5A Oct. 2017

© Flex

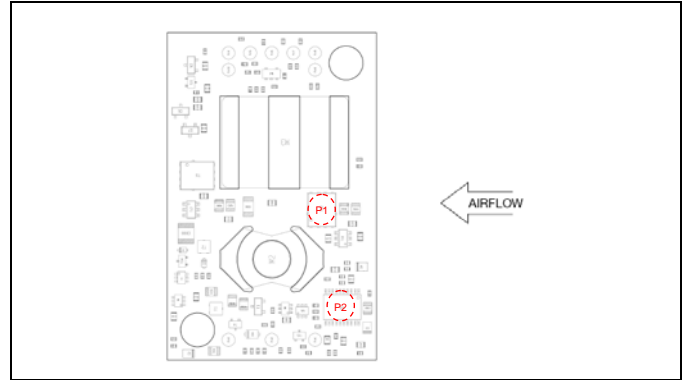
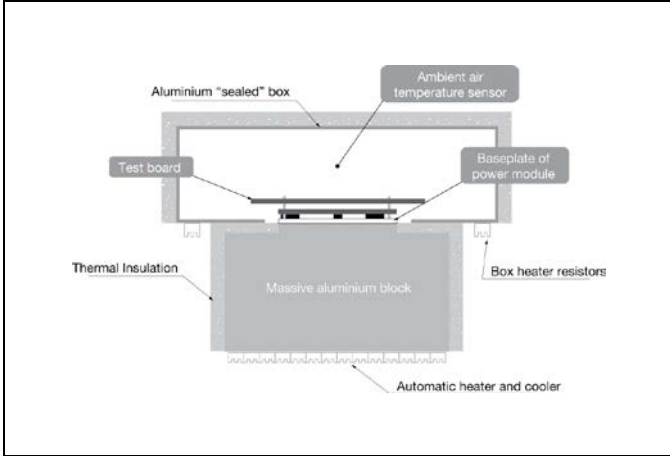

Base plate

### Definition of product operating temperature

The product operating temperature is used to monitor the temperature of the product, and proper thermal conditions can be verified by measuring the temperature at positions P1, P2. The temperature at these positions  $T_{P1}$ ,  $T_{P2}$  should not exceed the maximum temperatures in the table below. The number of measurement points may vary with different thermal design and topology. Temperatures above maximum  $T_{P1}$ , measured at the reference point P1 are not allowed and may cause permanent damage.

Position	Description	Max Temp.
P1	MOSFET	$T_{P1}=125^{\circ}\text{C}$
P2	Control IC	$T_{P2}=125^{\circ}\text{C}$

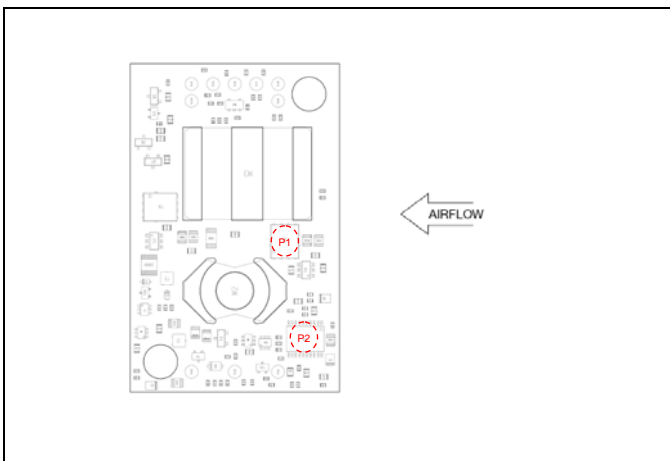

Open frame

### Ambient Temperature Calculation

For products with base plate the maximum allowed ambient temperature can be calculated by using the thermal resistance.

- The power loss is calculated by using the formula  $((1/\eta) - 1) \times \text{output power} = \text{power losses (Pd)}$ .  
 $\eta$  = efficiency of product. E.g. 89.5% = 0.895
- Find the thermal resistance ( $R_{th}$ ) in the Thermal Resistance graph found in the Output section for each model. **Note that the thermal resistance can be significantly reduced if a heat sink is mounted on the top of the base plate.**

Calculate the temperature increase ( $\Delta T$ ).

$$\Delta T = R_{th} \times P_d$$

3. Max allowed ambient temperature is:

$$\text{Max } T_{P1} - \Delta T.$$

E.g. PKM 4211C PINBHC at 2m/s:

$$1. ((\frac{1}{0.888}) - 1) \times 200 \text{ W} = 25.22 \text{ W}$$

$$2. 25.22 \text{ W} \times 3.5^{\circ}\text{C/W} = 88.3^{\circ}\text{C}$$

$$3. 125^{\circ}\text{C} - 88.3^{\circ}\text{C} = \text{max ambient temperature is } 36.7^{\circ}\text{C}$$

The actual temperature will be dependent on several factors such as the PCB size, number of layers and direction of airflow.

PKM 4000C PINB series Direct Converters  
 Input 36-75 V, Output up to 100 A / 204 W

EN/LZT 146 415 R5A Oct. 2017

© Flex

## Connections

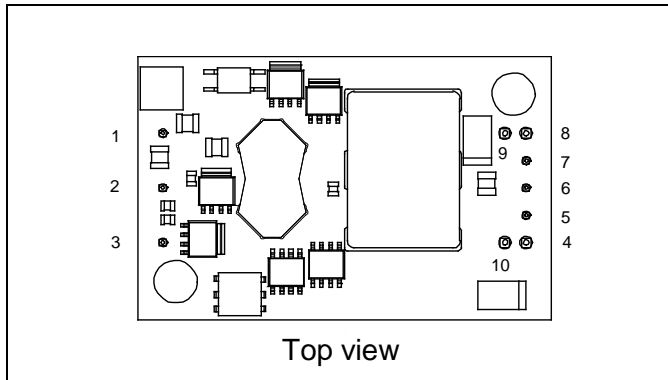

Pin	Designation	Function
1	+In	Positive input
2	RC	Remote control
3	- In	Negative input
4,10	- Out	Negative output
5	- Sen	Negative remote sense
6	Vadj	Output voltage adjust
7	+ Sen	Positive remote sense
8,9	+ Out	Positive output

PKM 4000C PINB series Direct Converters  
 Input 36-75 V, Output up to 100 A / 204 W

EN/LZT 146 415 R5A Oct. 2017

© Flex

**Mechanical Drawing (Open Frame with Holes)**

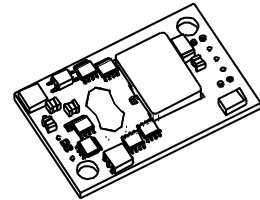
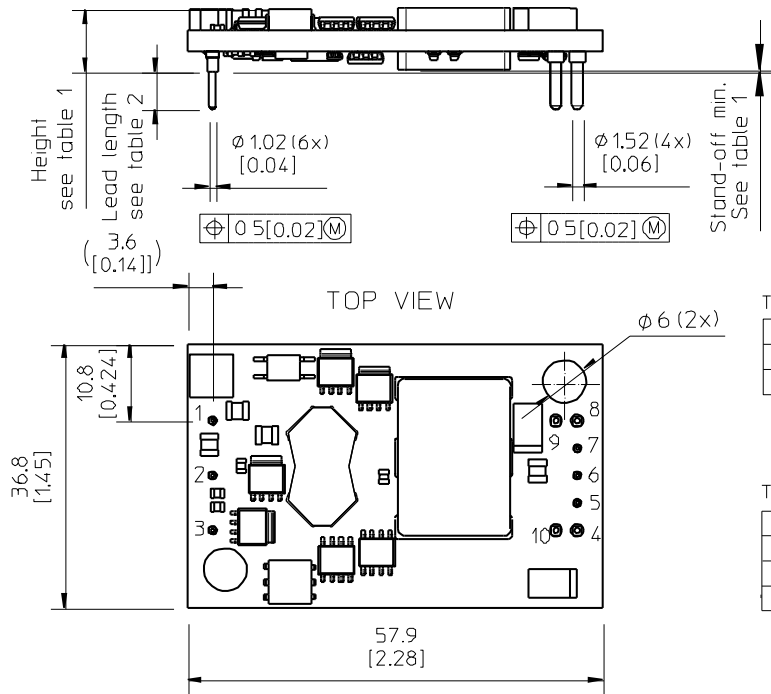

Table 1

Height option	Height max.	Stand-off min.
Standard	9.35 [0.368]	0.07 [0.003]
M	10.53 [0.415]	1.25 [0.049]

Table 2

Pin option	Lead Length
Standard	5.33 [0.210]
LA	3.69 [0.145]
LB	4.57 [0.180]

Recommended footprint - TOP VIEW

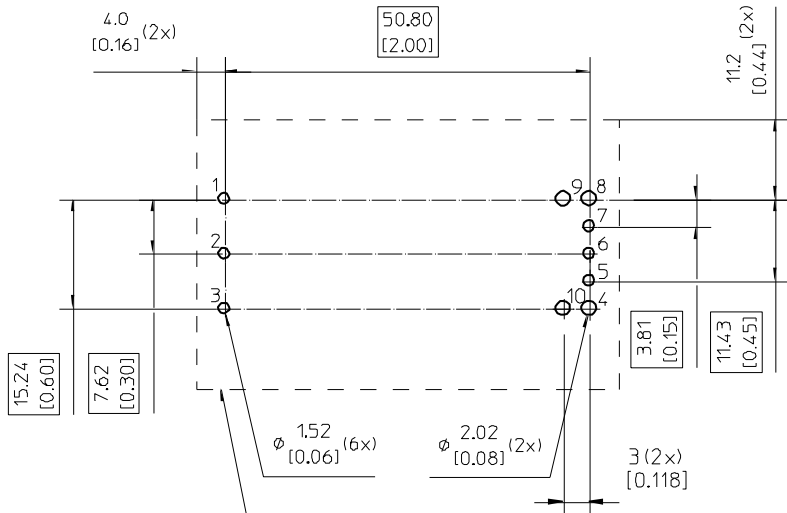

Recommended keep away area  
 for user components.

Weight: Typical 40g

Pins:

Material, pins 1-3, 5-7: Brass

Material, pins 4, 8, 9-10: Copper alloy

Pins 9-10 are optional according to 13132-BMR637-

Plating: 0.1 μm Gold over 2 μm Nickel

All dimensions are in mm [inches]

Tolerances unless specified

x.x ± 0.5 [0.02]

x.xx ± 0.25 [0.01]

Not applied on the recommended footprint



PKM 4000C PINB series Direct Converters  
 Input 36-75 V, Output up to 100 A / 204 W

EN/LZT 146 415 R5A Oct. 2017

© Flex

**Mechanical Drawing (Open Frame without Holes)**

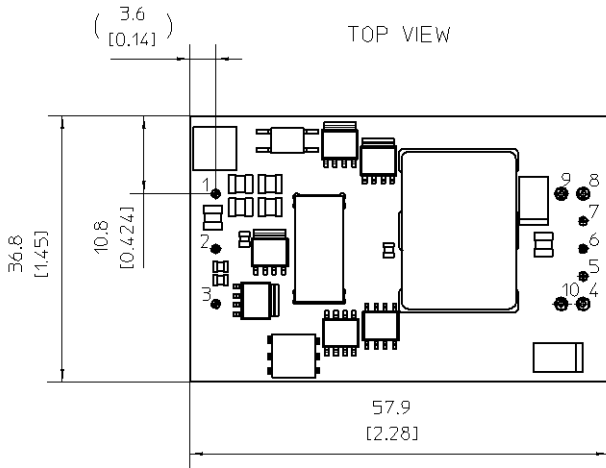
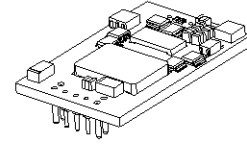
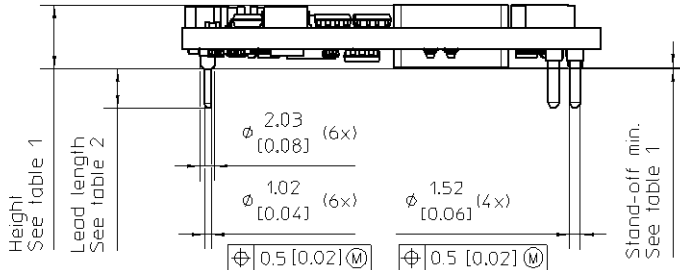

Table 1

Height option	Height max.	Stand-off min.
Standard	9.35 [0.368]	0.07 [0.003]
M	10.53 [0.415]	1.25 [0.049]

Table 2

Pin option	Lead Length
Standard	5.33 [0.210]
LA	3.69 [0.145]
LB	4.57 [0.180]

Recommended footprint - TOP VIEW

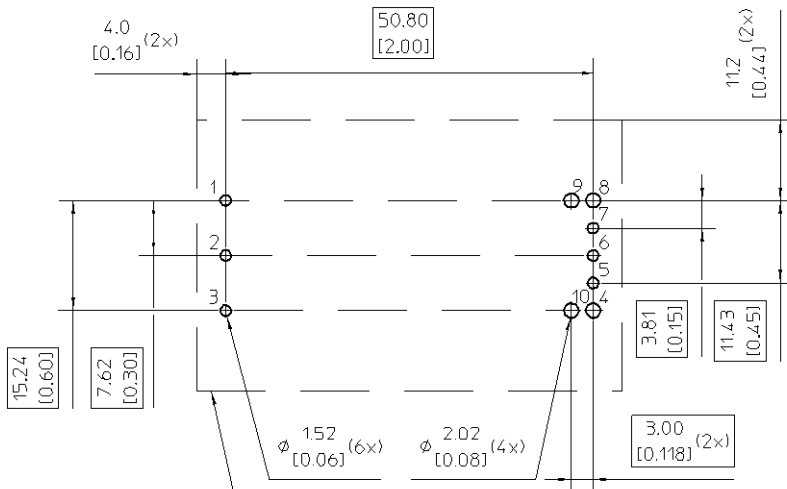

Recommended keep away area for user components.

Weight: Typical 40g

Pins:  
 Material, pins 1-3, 5-7: Brass  
 Material, pins 4, 8, 9-10: Copper alloy  
 Pins 9-10 are optional according to 13132-BMR637=  
 Plating: 0,1  $\mu$ m Gold over 2  $\mu$ m Nickel

All dimensions are in mm [inches]

Tolerances unless specified

x.x  $\pm$  0.5 [0.02]

x.xx  $\pm$  0.25 [0.01]

Not applied on the recommended footprint



PKM 4000C PINB series Direct Converters  
 Input 36-75 V, Output up to 100 A / 204 W

EN/LZT 146 415 R5A Oct. 2017

© Flex

Mechanical Drawing (Base Plate Version with Inserts)

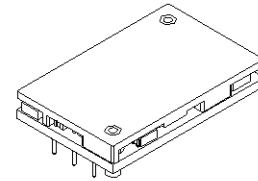
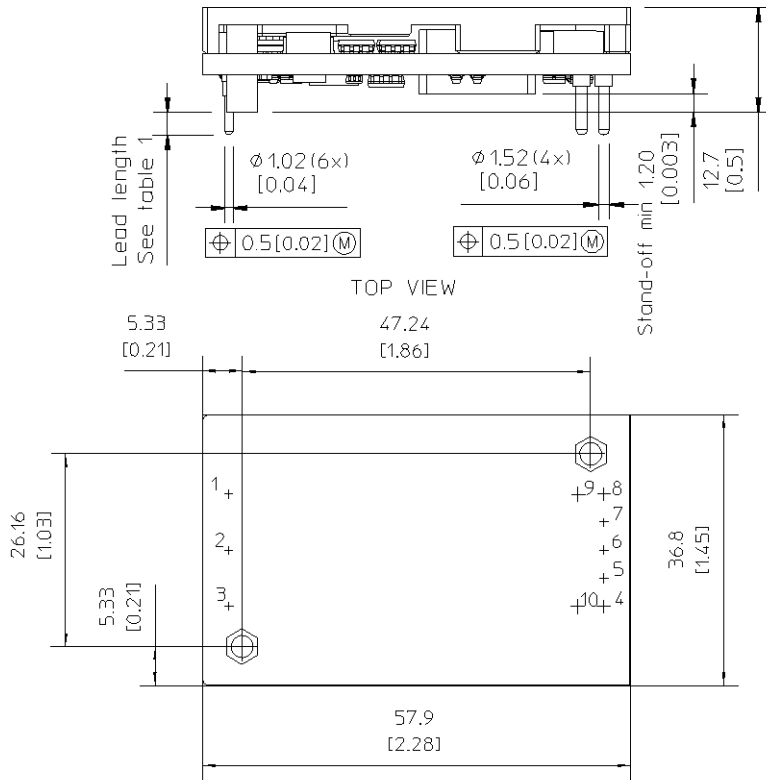

Table 1

Pin option	Lead Length
Standard	3.87 [0.210]
LA	3.69 [0.145]

Weight: Typical 65g

Pins:

Material, pins 1-3, 5-7: Brass

Material, pins 4, 8, 9-10: Copper alloy

Pins 9-10 are optional according to 13132-BMR637=

Plating: 0,1 µm Gold over 2 µm Nickel

Recommended footprint - TOP VIEW

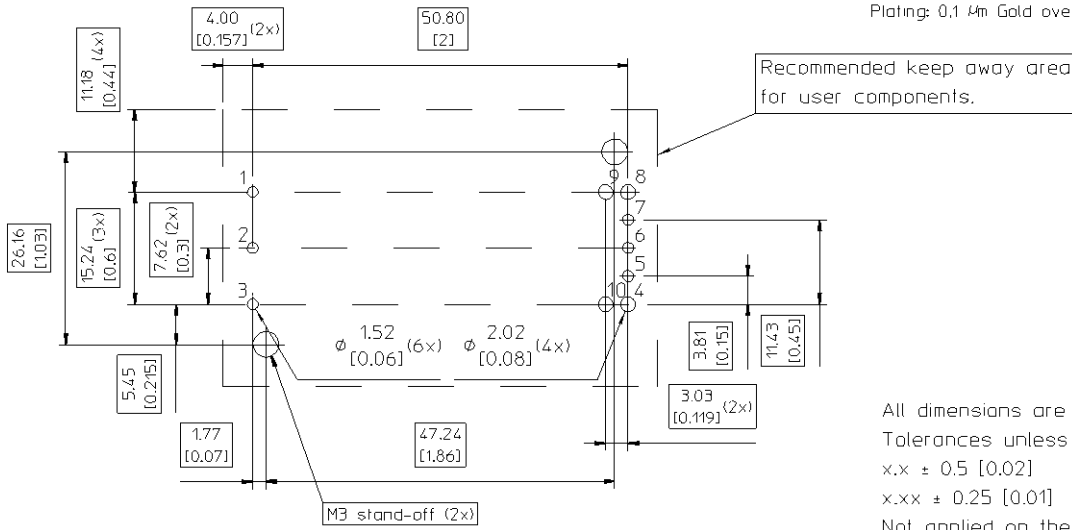

All dimensions are in mm [inches]

Tolerances unless specified

x.x ± 0.5 [0.02]

x.xx ± 0.25 [0.01]

Not applied on the recommended footprint





PKM 4000C PINB series Direct Converters  
 Input 36-75 V, Output up to 100 A / 204 W

EN/LZT 146 415 R5A Oct. 2017

© Flex

Mechanical Drawing (Base Plate Version without Inserts)

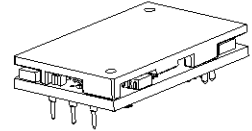
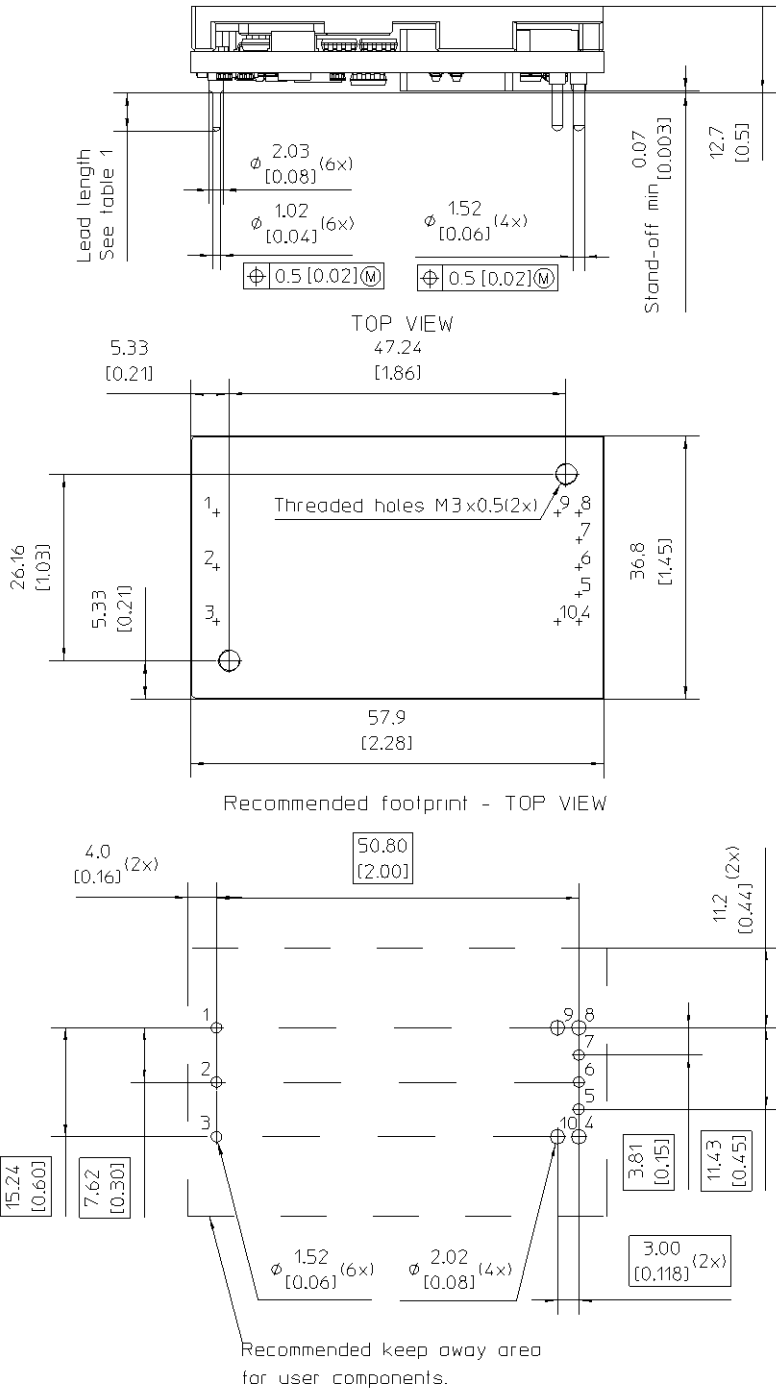

Table 1

Pin option	Lead Length
Standard	5.33 [0.210]
LA	3.69 [0.145]
LB	4.57 [0.180]

Weight: Typical 68g

Pins:

Material, pins 1-3, 5-7: Brass

Material, pins 4, 8, 9-10: Copper alloy

Pins 9-10 are optional according to 13132-BMR637=

Plating: 0.1  $\mu$ m Gold over 2  $\mu$ m Nickel

All dimensions are in mm [inches]

Tolerances unless specified

x.x  $\pm$  0.5 [0.02]

x.xxx  $\pm$  0.25 [0.01]

Not applied on the recommended footprint



PKM 4000C PINB series Direct Converters  
 Input 36-75 V, Output up to 100 A / 204 W

EN/LZT 146 415 R5A Oct. 2017

© Flex

**Soldering Information - Hole Mounting**

The hole mounted product is intended for plated through hole mounting by wave or manual soldering. The pin temperature is specified to maximum to 270°C for maximum 10 seconds.

A maximum preheat rate of 4°C/s and maximum preheat temperature of 150°C is suggested. When soldering by hand, care should be taken to avoid direct contact between the hot soldering iron tip and the pins for more than a few seconds in order to prevent overheating.

A no-clean flux is recommended to avoid entrapment of cleaning fluids in cavities inside the product or between the product and the host board. The cleaning residues may affect long time reliability and isolation voltage.

**Delivery Package Information**

The products are delivered in antistatic trays

Tray Specifications	
Material	Antistatic PPE
Surface resistance	$10^5 < \text{Ohm/square} < 10^{12}$
Bakability	The trays are not bakable
Tray thickness	25.4 mm [1.0 inch]
Box capacity	20 products (1 full tray/box)
Tray weight	100 g empty, 1400 g full tray

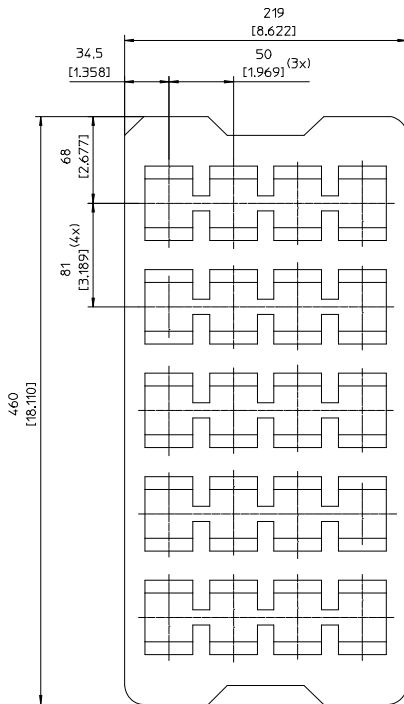

PKM 4000C PINB series Direct Converters Input 36-75 V, Output up to 100 A / 204 W	EN/LZT 146 415 R5A Oct. 2017
	© Flex

**Product Qualification Specification**

Characteristics			
External visual inspection	IPC-A-610		
Change of temperature (Temperature cycling)	IEC 60068-2-14 Na	Temperature range Number of cycles Dwell/transfer time	-40 to 100°C 1000 15 min/0-1 min
Cold (in operation)	IEC 60068-2-1 Ad	Temperature T <sub>A</sub> Duration	-45°C 72 h
Damp heat	IEC 60068-2-67 Cy	Temperature Humidity Duration	85°C 85 % RH 1000 hours
Dry heat	IEC 60068-2-2 Bd	Temperature Duration	125°C 1000 h
Electrostatic discharge susceptibility	IEC 61340-3-1, JESD 22-A114 IEC 61340-3-2, JESD 22-A115	Human body model (HBM) Machine Model (MM)	Class 2, 2000 V Class 3, 200 V
Immersion in cleaning solvents	IEC 60068-2-45 XA, method 2	Water Glycol ether	55°C 35°C
Mechanical shock	IEC 60068-2-27 Ea	Peak acceleration Duration	100 g 6 ms
Operational life test	MIL-STD-202G, method 108A	Duration	1000 h
Resistance to soldering heat	IEC 60068-2-20 Tb, method 1A	Solder temperature Duration	270°C 10-13 s
Robustness of terminations	IEC 60068-2-21 Test Ua1	Through hole mount products	All leads
Solder-ability	IEC 60068-2-58 test Td <sup>1</sup>	Preconditioning Temperature, SnPb Eutectic Temperature, Pb-free	150°C dry bake 16 h 215°C 235°C
Vibration, broad band random	IEC 60068-2-64 Fh, method 1	Frequency Spectral density Duration	10 to 500 Hz 0.07 g <sup>2</sup> /Hz 10 min in each direction

## X-ON Electronics

Largest Supplier of Electrical and Electronic Components

*Click to view similar products for [Isolated DC/DC Converters](#) category:*

*Click to view products by [Flex Power Modules](#) manufacturer:*

Other Similar products are found below :

[ESM6D044440C05AAQ](#) [MI-220-IW](#) [MI-J22-IY](#) [FMD15.24G](#) [PSL486-7LR](#) [PSR152.5-7IR](#) [Q48T30020-NBB0](#) [AVO240-48S12B-6L](#)  
[AVO250-48S28B-6L](#) [NAN-0505](#) [HW-L16D](#) [JAHW100Y1](#) [217-1617-001](#) [22827](#) [SPB05C-12](#) [SQ24S15033-PS0S](#) [18952](#) [19-130041](#) [CE-1003](#) [CE-1004](#) [GQ2541-7R](#) [PSE1000DCDC-12V](#) [RDS180245](#) [MAU228](#) [419-2065-201](#) [449-2075-101](#) [J80-0041NL](#) [V24C12M100BL](#)  
[V24C5C100BL2](#) [V300C12C150BG](#) [V375C24E150BG](#) [VE-JW3-CY](#) [VI-241-EU](#) [419-2062-200](#) [419-2063-401](#) [419-2067-101](#) [419-2067-501](#)  
[419-2068-001](#) [DCG40-5G](#) [DFC15U48D15](#) [449-2067-000](#) [XGS-0512](#) [XGS-1205](#) [XGS-1212](#) [XGS-2412](#) [XGS-2415](#) [XKS-1215](#) [033456](#)  
[NCT1000N040R050B](#) [SPB05B-15](#)