

PMM 8000 series PoL Regulators
 Input 8-14 V, Output 50 A / 275 W

2/ 28701- BMR 651 Rev. A November 2017

© Flex

Key Features

- 50A output current
- 8-14V input voltage range
- Output voltages from 0.8V up to 5.5V
- Industry standard POLA™ compatible
- 52 x 26.7x 9.07 mm (2.05 x 1.05 x 0.357 in.)
- High efficiency, up to .96%
- Auto Track™ sequencing pin
- Differential output voltage sense
- More than 1.27 million hours MTBF

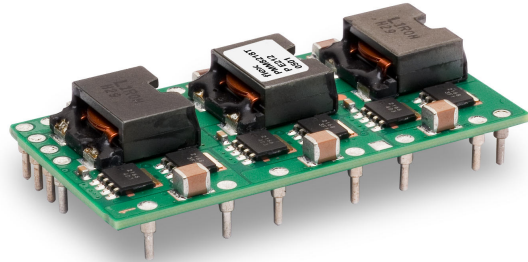

General Characteristics

- Operating temperature: -40°C to 85 °C
- Start up into a pre-biased output safe
- Output short-circuit protection
- Over temperature protection
- On/Off inhibit control
- Margin up/down control
- Highly automated manufacturing ensures quality
- ISO 9001/14001 certified supplier

Safety Approvals



Design for Environment



Meets requirements in high-temperature lead-free soldering processes.

Contents

General Information	2
Safety Specification	3
Absolute Maximum Ratings	4
Product Program	Ordering No.
0.8-5.5 V/50 A	PMM 8218T
1.0 V/50 A Electrical Specification	5
1.2 V/50 A Electrical Specification	8
1.5 V/50 A Electrical Specification	11
1.8 V/50 A Electrical Specification	14
2.5 V/50 A Electrical Specification	17
3.3 V/50 A Electrical Specification	20
5.0 V/50 A Electrical Specification	23
EMC Specification	26
Operating Information	26
Thermal Consideration	28
Connections	29
Mechanical Information	30
Soldering Information	32
Delivery Information	33
Product Qualification Specification	34

PMM 8000 series PoL Regulators
Input 8-14 V, Output 50 A / 275 W

2/ 28701- BMR 651 Rev. A November 2017

© Flex

General Information

Ordering Information

See Contents for individual product ordering numbers.

Option	Suffix	Ordering No.
Through hole pin	P	PMM 8218T P
SMD pin, leadfree reflow temperature capable	SR	PMM 8218T SR

Reliability

The Mean Time Between Failure (MTBF) is calculated at full output power and an operating ambient temperature (T_A) of +40°C, which is a typical condition in Information and Communication Technology (ICT) equipment. Different methods could be used to calculate the predicted MTBF and failure rate which may give different results. Flex currently uses Telcordia SR332.

Predicted MTBF for the series is:

- 1.27 million hours according to Telcordia SR332, issue 1, Black box technique.

Telcordia SR332 is a commonly used standard method intended for reliability calculations in ICT equipment. The parts count procedure used in this method was originally modelled on the methods from MIL-HDBK-217F, Reliability Predictions of Electronic Equipment. It assumes that no reliability data is available on the actual units and devices for which the predictions are to be made, i.e. all predictions are based on generic reliability parameters.

Compatibility with RoHS requirements

The products are compatible with the relevant clauses and requirements of the RoHS directive 2011/65/EU and have a maximum concentration value of 0.1% by weight in homogeneous materials for lead, mercury, hexavalent chromium, PBB and PBDE and of 0.01% by weight in homogeneous materials for cadmium.

Exemptions in the RoHS directive utilized in Flex products are found in the Statement of Compliance document.

Flex fulfills and will continuously fulfill all its obligations under regulation (EC) No 1907/2006 concerning the registration, evaluation, authorization, and restriction of chemicals (REACH) as they enter into force and is through product materials declarations preparing for the obligations to communicate information on substances in the products.

Quality Statement

The products are designed and manufactured in an industrial environment where quality systems and methods like ISO 9000, 6 σ (sigma), and SPC are intensively in use to boost the continuous improvements strategy. Infant mortality or early failures in the products are screened out and they are subjected to an ATE-based final test. Conservative design rules, design reviews and product qualifications, plus the high competence of an engaged work force, contribute to the high quality of our products.

Warranty

Warranty period and conditions are defined in Flex General Terms and Conditions of Sale.

Limitation of Liability

Flex does not make any other warranties, expressed or implied including any warranty of merchantability or fitness for a particular purpose (including, but not limited to, use in life support applications, where malfunctions of product can cause injury to a person's health or life).

© Flex 2017

The information and specifications in this technical specification is believed to be correct at the time of publication. However, no liability is accepted for inaccuracies, printing errors or for any consequences thereof. Flex reserves the right to change the contents of this technical specification at any time without prior notice.

PMM 8000 series PoL Regulators
Input 8-14 V, Output 50 A / 275 W

2/ 28701- BMR 651 Rev. A November 2017

© Flex

Safety Specification

General information

Flex DC/DC converters and DC/DC regulators are designed in accordance with safety standards IEC/EN/UL60950, *Safety of Information Technology Equipment*.

IEC/EN/UL60950 contains requirements to prevent injury or damage due to the following hazards:

- Electrical shock
- Energy hazards
- Fire
- Mechanical and heat hazards
- Radiation hazards
- Chemical hazards

On-board DC-DC converters are defined as component power supplies. As components they cannot fully comply with the provisions of any Safety requirements without “Conditions of Acceptability”. It is the responsibility of the installer to ensure that the final product housing these components complies with the requirements of all applicable Safety standards and Directives for the final product.

Component power supplies for general use should comply with the requirements in IEC60950, EN60950 and UL60950 “*Safety of information technology equipment*”.

There are other more product related standards, e.g. IEEE802.3af “Ethernet LAN/MAN Data terminal equipment power”, and ETS300132-2 “Power supply interface at the input to telecommunications equipment; part 2: DC”, but all of these standards are based on IEC/EN/UL60950 with regards to safety.

Flex DC/DC converters and DC/DC regulators are UL60950 recognized and certified in accordance with EN60950.

The flammability rating for all construction parts of the products meets requirements for V-0 class material according to IEC 60695-11-10.

The products should be installed in the end-use equipment, in accordance with the requirements of the ultimate application. Normally the output of the DC/DC converter is considered as SELV (Safety Extra Low Voltage) and the input source must be isolated by minimum Double or Reinforced Insulation from the primary circuit (AC mains) in accordance with IEC/EN/UL60950.

Isolated DC/DC converters

It is recommended that a slow blow fuse with a rating twice the maximum input current per selected product be used at the input of each DC/DC converter. If an input filter is used in the circuit the fuse should be placed in front of the input filter.

In the rare event of a component problem in the input filter or in the DC/DC converter that imposes a short circuit on the input source, this fuse will provide the following functions:

- Isolate the faulty DC/DC converter from the input power source so as not to affect the operation of other parts of the system.
- Protect the distribution wiring from excessive current and power loss thus preventing hazardous overheating.

The galvanic isolation is verified in an electric strength test. The test voltage (V_{iso}) between input and output is 1500 Vdc or 2250 Vdc for 60 seconds (refer to product specification).

Leakage current is less than 1 μ A at nominal input voltage.

24 V DC systems

The input voltage to the DC/DC converter is SELV (Safety Extra Low Voltage) and the output remains SELV under normal and abnormal operating conditions.

48 and 60 V DC systems

If the input voltage to Flex DC/DC converter is 75 Vdc or less, then the output remains SELV (Safety Extra Low Voltage) under normal and abnormal operating conditions.

Single fault testing in the input power supply circuit should be performed with the DC/DC converter connected to demonstrate that the input voltage does not exceed 75 Vdc.

If the input power source circuit is a DC power system, the source may be treated as a TNV2 circuit and testing has demonstrated compliance with SELV limits and isolation requirements equivalent to Basic Insulation in accordance with IEC/EN/UL60950.

Non-isolated DC/DC regulators

The input voltage to the DC/DC regulator is SELV (Safety Extra Low Voltage) and the output remains SELV under normal and abnormal operating conditions.

PMM 8000 series PoL Regulators
 Input 8-14 V, Output 50 A / 275 W

2/ 28701- BMR 651 Rev. A November 2017

© Flex

Absolute Maximum Ratings

Characteristics		min	typ	max	Unit
T_{amb}	Operating Temperature (see Thermal Consideration section)	-40		85	°C
T_S	Storage temperature	-40		125	°C
V_I	Input voltage	8.0	12.0	14.0	V
V_{inh}	Inhibit On/Off pin voltage (see Operating Information section)	Positive logic option		Open	V
		Negative logic option	N/A	N/A	V

Stress in excess of Absolute Maximum Ratings may cause permanent damage. Absolute Maximum Ratings, sometimes referred to as no destruction limits, are normally tested with one parameter at a time exceeding the limits of Output data or Electrical Characteristics. If exposed to stress above these limits, function and performance may degrade in an unspecified manner.

Fundamental Circuit Diagram

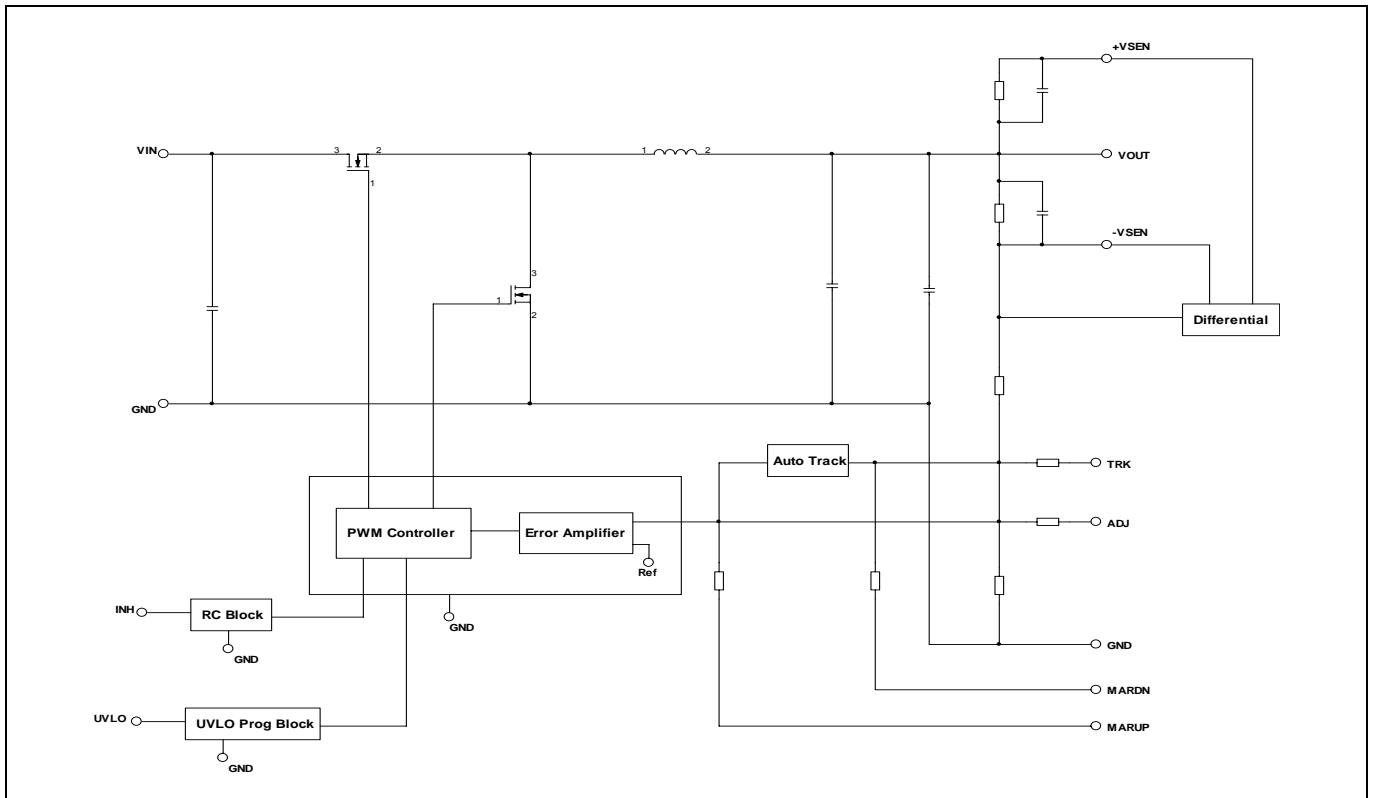

PMM 8000 series PoL Regulators
 Input 8-14 V, Output 50 A / 275 W

2/ 28701- BMR 651 Rev. A November 2017

© Flex

1.0 V/50 A Electrical Specification

PMM 8218T

$T_{ref} = -40$ to $+85^{\circ}\text{C}$, $V_I = 8.0$ to 14.0 V, $R_{adj} = 38.3$ k Ω , unless otherwise specified under Conditions.

Typical values given at: $T_{ref} = +25^{\circ}\text{C}$, $V_I = 12.0$ V, max I_O , unless otherwise specified under Conditions.

Additional $C_{in} = 1000\mu\text{F}$ and $C_{out} = 660\mu\text{F}$. See Operating Information section for selection of capacitor types.

Connect the sense pin, where available, to the output pin.

Characteristics		Conditions	min	typ	max	Unit
V_I	Input voltage range		8.0		14.0	V
UVLO	Undervoltage lockout	Pin 8 open	On-threshold		14.0	V
			Hysteresis			
C_I	Internal input capacitance			80		μF
P_O	Output power		0		50	W
η	Efficiency	50 % of max I_O		85.9		%
		max I_O		82.5		
P_d	Power Dissipation	max I_O		10.6		W
P_{li}	Input idling power	$I_O = 0$, $V_I = 12.0$ V		1360		mW
P_{inh}	Input standby power	$V_I = 12.0$ V (turned off with INHIBIT)		420		mW
I_S	Static Input current	$V_I = 12.0$ V, max I_O		5.1		A
f_s	Switching frequency	0-100 % of max I_O	900	1050	1200	kHz

V_{O_i}	Output voltage initial setting and accuracy	$T_{ref} = +25^{\circ}\text{C}$, $V_I = 12.0$ V, max I_O	0.980	1.000	1.020	V
V_O	Output voltage tolerance band	10-100 % of max I_O	0.970		1.030	V
	Idling voltage	$I_O = 0$		0.998		V
	Line regulation	max I_O		± 5		mV
	Load regulation	$V_I = 12.0$ V, 0-100 % of max I_O		± 5		mV
V_{tr}	Load transient voltage deviation	$V_I = 12.0$ V, Load step 50-100-50 % of max I_O , $di/dt = 1$ A/ μs , see Note 1		± 75		mV
t_{tr}	Load transient recovery time			100		μs
t_r	Ramp-up time (from 10-90 % of V_O)	max I_O		2.2		ms
t_s	Start-up time (from V_I connection to 90% of V_O)				6.4	
t_f	Ramp-down time (from 90-10 % of V_O)	Max I_O		10		μs
		$I_O = 0.1$ A		25.1		ms
t_{inh}	INHIBIT start-up time	Max I_O		5.6		ms
	INHIBIT shutdown fall time (From INHIBIT off to 10% of V_O)	Max I_O		30		μs
		$I_O = 0.1$ A		3.8		ms
I_O	Output current		0		50	A
I_{lim}	Current limit threshold	$T_{ref} < \text{max } T_{ref}$		95		A
V_{Oac}	Output ripple & noise	See ripple & noise section, max I_O , V_{O_i}		15		mVp-p

Note 1: Output filter according to Ripple & Noise section

PMM 8000 series PoL Regulators
Input 8-14 V, Output 50 A / 275 W

2/ 28701- BMR 651 Rev. A November 2017
© Flex

1.0 V/50 A Typical Characteristics

PMM 8218T

Efficiency

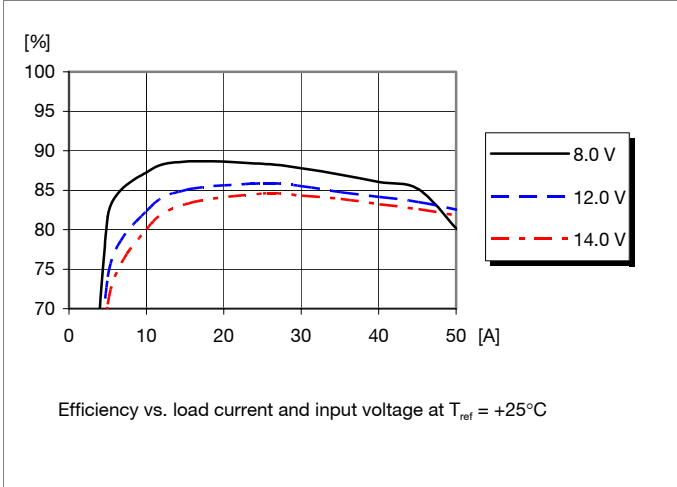

Power Dissipation

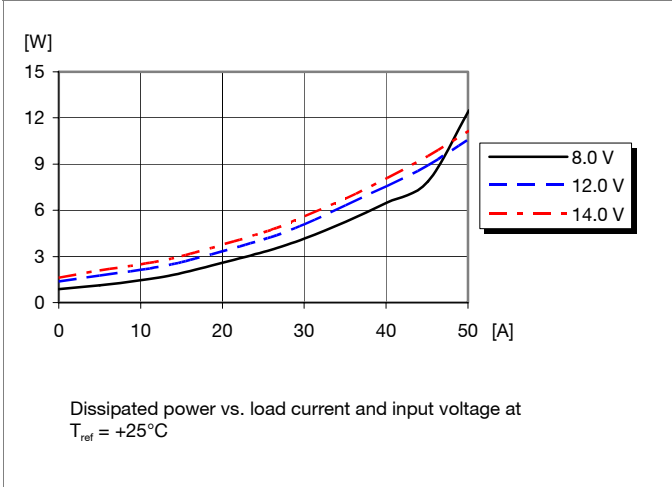

Output Current Derating

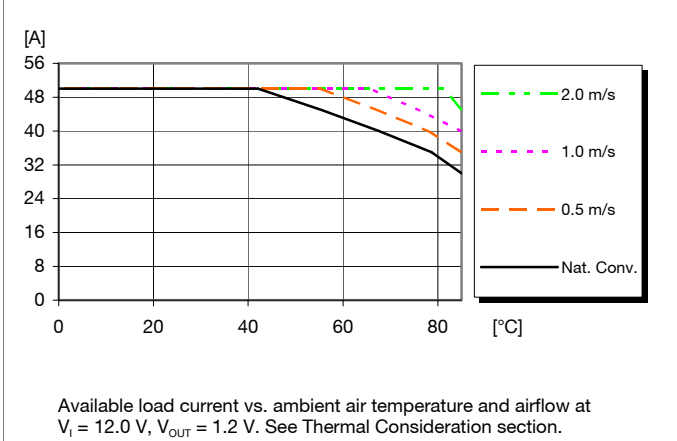

Output Characteristics

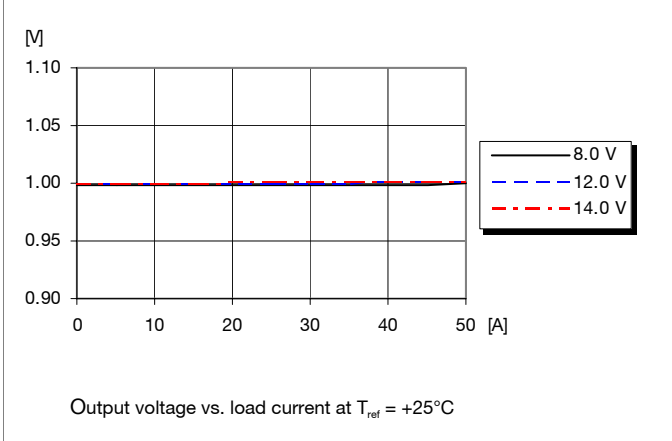

PMM 8000 series PoL Regulators
 Input 8-14 V, Output 50 A / 275 W

2/ 28701- BMR 651 Rev. A November 2017

© Flex

1.0 V/50 A Typical Characteristics

PMM 8218T

Start-up

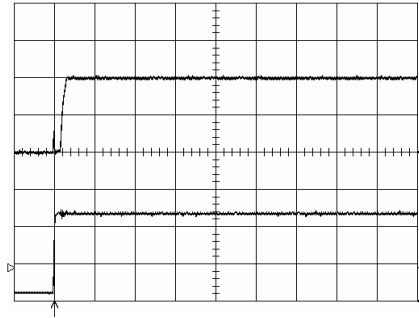

Start-up enabled by connecting V_i at:
 $T_{ref} = +25^{\circ}\text{C}$, $I_o = 50\text{ A}$ resistive load,
 $V_i = 12.0\text{ V}$.

Top trace: output voltage (0.5 V/div.).
 Bottom trace: input voltage (5 V/div.).
 Time scale: 20 ms/div.

Shut-down

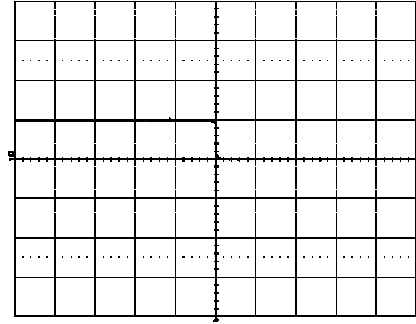

Shut-down enabled by disconnecting V_i at:
 $T_{ref} = +25^{\circ}\text{C}$, $I_o = 50\text{ A}$ resistive load,
 $V_i = 12.0\text{ V}$.

Top trace: output voltage (1.0 V/div.).
 Time scale: 1.0 ms/div.

Output Ripple & Noise

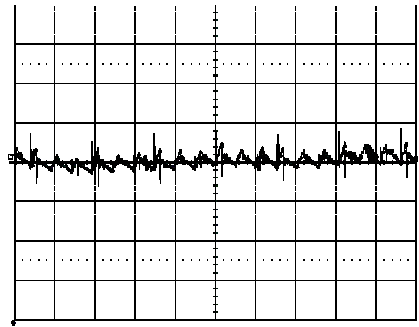

Output voltage ripple (20 mV/div.) at:
 $T_{ref} = +25^{\circ}\text{C}$, $I_o = 50\text{ A}$ resistive load,
 $V_i = 12.0\text{ V}$. Time scale: 2 μs /div.

See the filter in the Output ripple and noise section (EMC Specification).

Output Load Transient Response

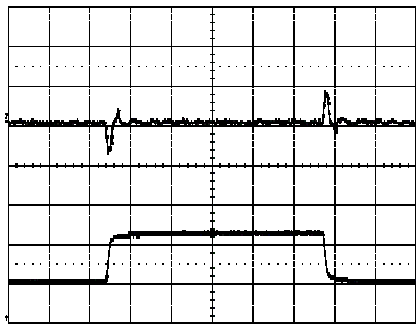

Output voltage response to load current step-change (25-50-25 A) at:
 $T_{ref} = +25^{\circ}\text{C}$, $V_i = 12.0\text{ V}$.

Top trace: output voltage (100 mV/div.).
 Bottom trace: load current (20 A/div.).
 Time scale: 0.2 ms/div.

PMM 8000 series PoL Regulators
 Input 8-14 V, Output 50 A / 275 W

2/ 28701- BMR 651 Rev. A November 2017

© Flex

1.2 V/50 A Electrical Specification
PMM 8218T
 $T_{ref} = -40$ to $+85^{\circ}\text{C}$, $V_I = 8.0$ to 14.0 V, $R_{adj} = 18.2$ k Ω , unless otherwise specified under Conditions.

 Typical values given at: $T_{ref} = +25^{\circ}\text{C}$, $V_I = 12.0$ V, max I_O , unless otherwise specified under Conditions.

 Additional $C_{in} = 1000\mu\text{F}$ and $C_{out} = 660\mu\text{F}$. See Operating Information section for selection of capacitor types.

Connect the sense pin, where available, to the output pin.

Characteristics		Conditions	min	typ	max	Unit
V_I	Input voltage range		8.0		14.0	V
UVLO	Undervoltage lockout	Pin 8 open		On-threshold	7.5	V
				Hysteresis	1	
C_I	Internal input capacitance			80		μF
P_O	Output power		0		60	W
η	Efficiency	50 % of max I_O		87.9		%
		max I_O		84.9		
P_d	Power Dissipation	max I_O		10.7		W
P_{li}	Input idling power	$I_O = 0$, $V_I = 12.0$ V		1400		mW
P_{inh}	Input standby power	$V_I = 12.0$ V (turned off with INHIBIT)		420		mW
I_S	Static Input current	$V_I = 12.0$ V, max I_O		5.9		A
f_s	Switching frequency	0-100 % of max I_O	900	1050	1200	kHz

V_{oi}	Output voltage initial setting and accuracy	$T_{ref} = +25^{\circ}\text{C}$, $V_I = 12.0$ V, max I_O	1.176	1.200	1.224	V
V_O	Output voltage tolerance band	10-100 % of max I_O	1.164		1.236	V
	Idling voltage	$I_O = 0$		1.200		V
	Line regulation	max I_O		± 5		mV
	Load regulation	$V_I = 12.0$ V, 0-100% of max I_O		± 5		mV
V_{tr}	Load transient voltage deviation	$V_I = 12.0$ V, Load step 50-100-50 % of max I_O , $di/dt = 1$ A/ μs , see Note 1		± 80		mV
t_{tr}	Load transient recovery time			100		μs
t_r	Ramp-up time (from 10-90 % of V_{oi})	max I_O		2.2		ms
t_s	Start-up time (from V_I connection to 90% of V_{oi})			6.3		ms
t_f	Ramp-down time (from 90-10 % of V_{oi})	Max I_O		60		μs
		$I_O = 0.1$ A		29.9		ms
t_{inh}	INHIBIT start-up time	Max I_O		5.6		ms
	INHIBIT shutdown fall time (From INHIBIT off to 10% of V_{oi})	Max I_O		30		μs
		$I_O = 0.1$ A		4.5		ms
I_O	Output current		0		50	A
I_{lim}	Current limit threshold	$T_{ref} < \max T_{ref}$		95		A
V_{Oac}	Output ripple & noise	See ripple & noise section, max I_O , V_{oi}		15		mVp-p

Note 1: Output filter according to Ripple & Noise section

PMM 8000 series PoL Regulators
 Input 8-14 V, Output 50 A / 275 W

2/ 28701- BMR 651 Rev. A November 2017

© Flex

1.2 V/50 A Typical Characteristics

PMM 8218T

Efficiency

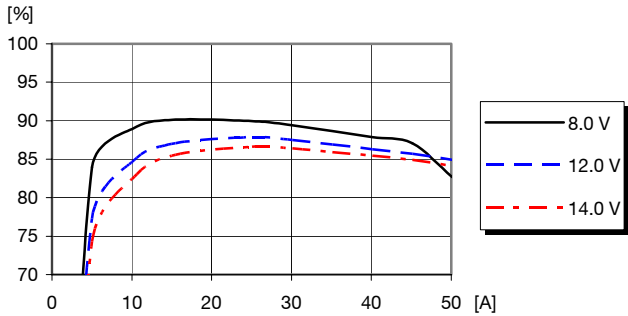

Efficiency vs. load current and input voltage at $T_{ref} = +25^{\circ}\text{C}$

Power Dissipation

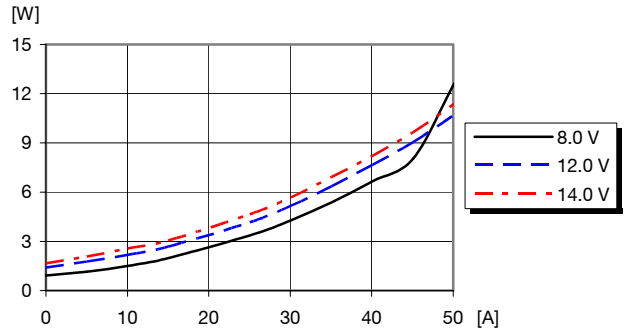

Dissipated power vs. load current and input voltage at $T_{ref} = +25^{\circ}\text{C}$

Output Current Derating

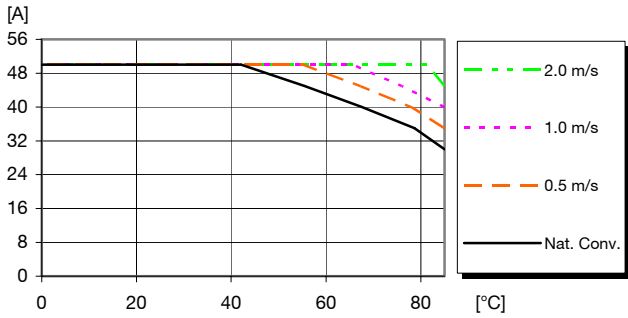

Available load current vs. ambient air temperature and airflow at $V_I = 12.0\text{ V}$, $V_{OUT} = 1.2\text{ V}$. See Thermal Consideration section.

Output Characteristics

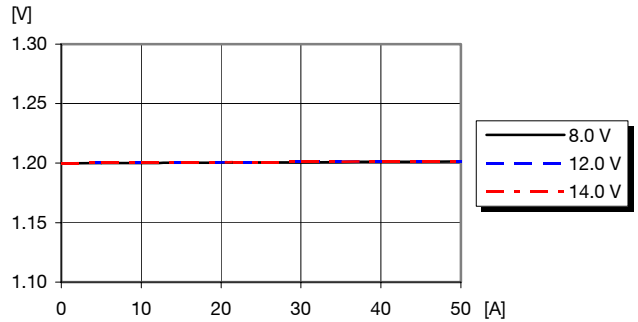

Output voltage vs. load current at $T_{ref} = +25^{\circ}\text{C}$

PMM 8000 series PoL Regulators
 Input 8-14 V, Output 50 A / 275 W

2/ 28701- BMR 651 Rev. A November 2017

© Flex

1.2 V/50 A Typical Characteristics

PMM 8218T

Start-up

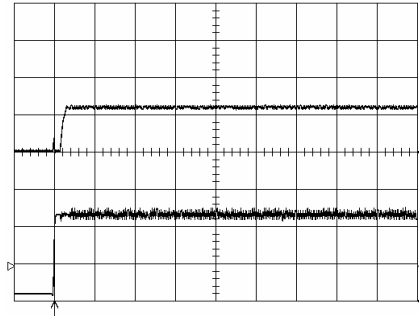

Start-up enabled by connecting V_i at:
 $T_{ref} = +25^\circ\text{C}$, $I_o = 50\text{ A}$ resistive load,
 $V_i = 12.0\text{ V}$.
 Top trace: output voltage (1.0 V/div.).
 Bottom trace: input voltage (5 V/div.).
 Time scale: 20 ms/div.

Shut-down

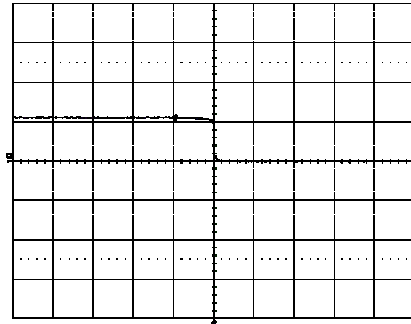

Shut-down enabled by disconnecting V_i at:
 $T_{ref} = +25^\circ\text{C}$, $I_o = 50\text{ A}$ resistive load,
 $V_i = 12.0\text{ V}$.
 Top trace: output voltage (1.0 V/div.).
 Time scale: 1.0 ms/div.

Output Ripple & Noise

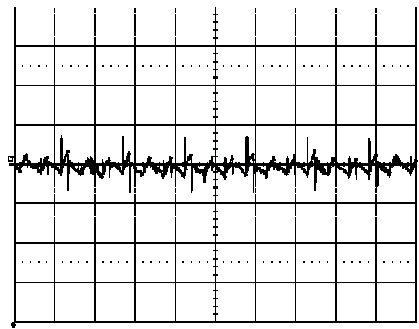

Output voltage ripple (20 mV/div.) at:
 $T_{ref} = +25^\circ\text{C}$, $I_o = 50\text{ A}$ resistive load,
 $V_i = 12.0\text{ V}$. Time scale: 2 μs /div.
 See the filter in the Output ripple and noise
 section (EMC Specification).

Output Load Transient Response

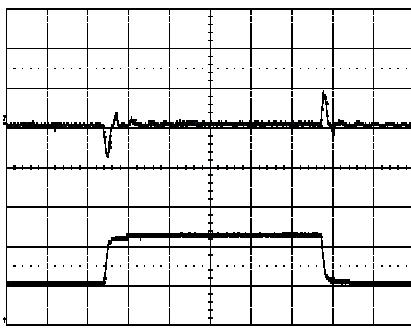

Output voltage response to load current step-
 change (25-50-25 A) at:
 $T_{ref} = +25^\circ\text{C}$, $V_i = 12.0\text{ V}$.
 Top trace: output voltage (100 mV/div.).
 Bottom trace: load current (20 A/div.).
 Time scale: 0.2 ms/div.

PMM 8000 series PoL Regulators
Input 8-14 V, Output 50 A / 275 W

2/ 28701- BMR 651 Rev. A November 2017

© Flex

1.5 V/50 A Electrical Specification

PMM 8218T

$T_{ref} = -40$ to $+85^{\circ}\text{C}$, $V_I = 8.0$ to 14.0 V, $R_{adj} = 9.76$ k Ω , unless otherwise specified under Conditions.

Typical values given at: $T_{ref} = +25^{\circ}\text{C}$, $V_I = 12.0$ V, max I_O , unless otherwise specified under Conditions.

Additional $C_{in} = 1000\mu\text{F}$ and $C_{out} = 660\mu\text{F}$. See Operating Information section for selection of capacitor types.

Connect the sense pin, where available, to the output pin.

Characteristics		Conditions	min	typ	max	Unit
V_I	Input voltage range		8.0		14.0	V
UVLO	Undervoltage lockout	Pin 8 open	On-threshold		7.5	V
			Hysteresis		1	
C_I	Internal input capacitance			80		μF
P_O	Output power		0		75	W
η	Efficiency	50 % of max I_O		89.8		%
		max I_O		87.3		
P_d	Power Dissipation	max I_O		10.9		W
P_{li}	Input idling power	$I_O = 0$, $V_I = 12.0$ V		1490		mW
P_{inh}	Input standby power	$V_I = 12.0$ V (turned off with INHIBIT)		420		mW
I_S	Static Input current	$V_I = 12.0$ V, max I_O		7.2		A
f_s	Switching frequency	0-100% of max I_O	900	1050	1200	kHz

V_{O_i}	Output voltage initial setting and accuracy	$T_{ref} = +25^{\circ}\text{C}$, $V_I = 12.0$ V, max I_O	1.470	1.500	1.530	V
V_O	Output voltage tolerance band	10-100% of max I_O	1.455		1.545	V
	Idling voltage	$I_O = 0$		1.497		V
	Line regulation	max I_O		± 5		mV
	Load regulation	$V_I = 12.0$ V, 0-100% of max I_O		± 5		mV
V_{tr}	Load transient voltage deviation	$V_I = 12.0$ V, Load step 50-100-50 % of max I_O , $di/dt = 1$ A/ μs , see Note 1		± 80		mV
t_{tr}	Load transient recovery time			100		μs
t_r	Ramp-up time (from 10–90 % of V_O)	max I_O		2.4		ms
t_s	Start-up time (from V_I connection to 90% of V_O)				6.3	
t_f	Ramp-down time (from 90–10 % of V_O)	Max I_O		100		μs
		$I_O = 0.1$ A		36.2		ms
t_{inh}	INHIBIT start-up time	Max I_O		5.6		ms
	INHIBIT shutdown fall time (From INHIBIT off to 10% of V_O)	Max I_O		70		μs
		$I_O = 0.1$ A		5.6		ms
I_O	Output current		0		50	A
I_{lim}	Current limit threshold	$T_{ref} < \max T_{ref}$		95		A
V_{Oac}	Output ripple & noise	See ripple & noise section, max I_O , V_{O_i}		15		mVp-p

Note 1: Output filter according to Ripple & Noise section

PMM 8000 series PoL Regulators
 Input 8-14 V, Output 50 A / 275 W

2/ 28701- BMR 651 Rev. A November 2017

© Flex

1.5 V/50 A Typical Characteristics

PMM 8218T

Efficiency

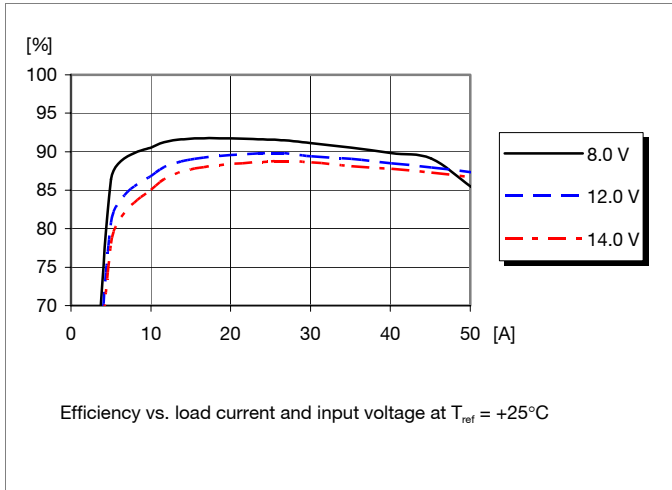

Power Dissipation

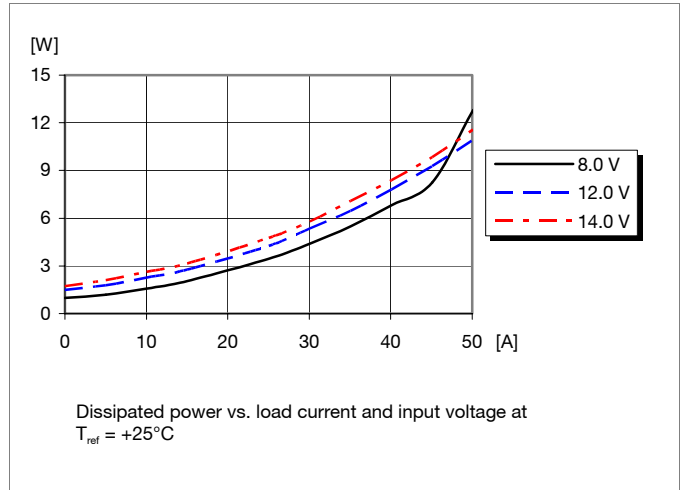

Output Current Derating

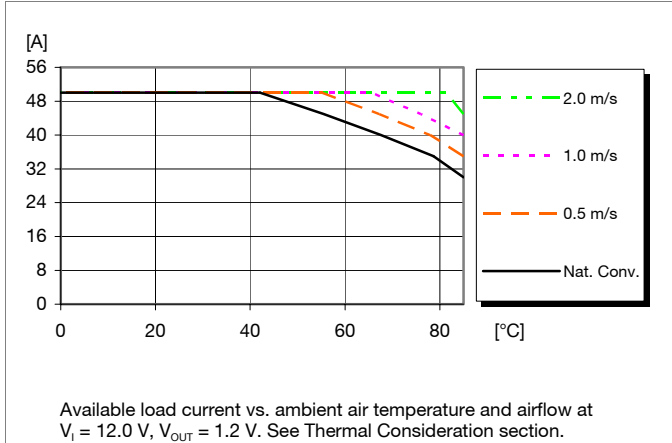

Output Characteristics

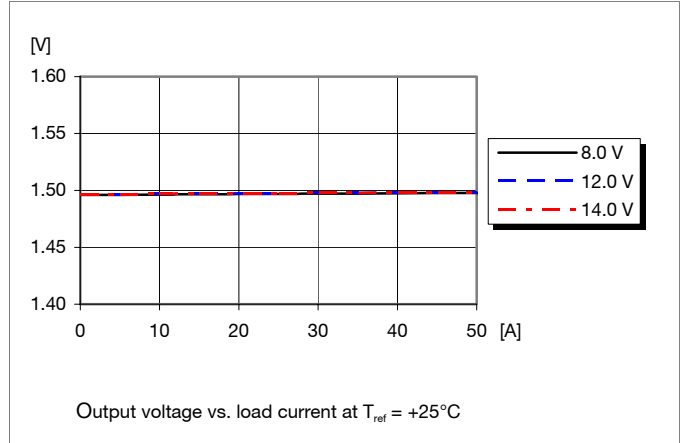

PMM 8000 series PoL Regulators
 Input 8-14 V, Output 50 A / 275 W

2/ 28701- BMR 651 Rev. A November 2017

© Flex

1.5 V/50 A Typical Characteristics

PMM 8218T

Start-up

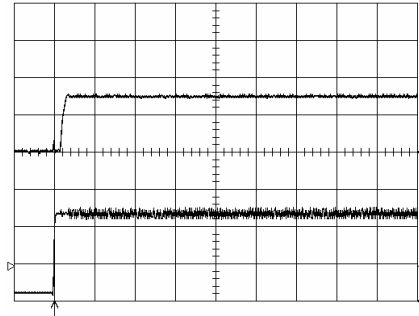

Start-up enabled by connecting V_i at:
 $T_{ref} = +25^{\circ}\text{C}$, $I_o = 50\text{ A}$ resistive load,
 $V_i = 12.0\text{ V}$.

Top trace: output voltage (1.0 V/div.).
 Bottom trace: input voltage (5 V/div.).
 Time scale: 20 ms/div..

Shut-down

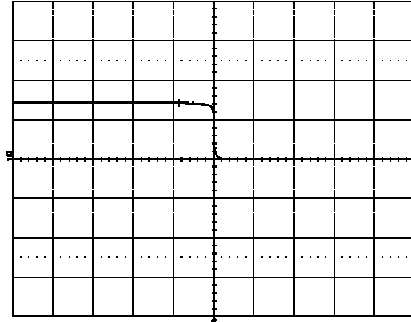

Shut-down enabled by disconnecting V_i at:
 $T_{ref} = +25^{\circ}\text{C}$, $I_o = 50\text{ A}$ resistive load,
 $V_i = 12.0\text{ V}$.

Top trace: output voltage (1.0 V/div.).
 Time scale: 1.0 ms/div.

Output Ripple & Noise

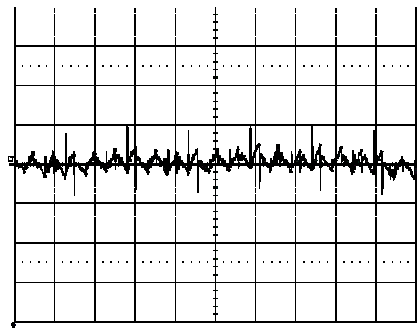

Output voltage ripple (20 mV/div.) at:
 $T_{ref} = +25^{\circ}\text{C}$, $I_o = 50\text{ A}$ resistive load,
 $V_i = 12.0\text{ V}$. Time scale: 2 $\mu\text{s}/\text{div}$.

See the filter in the Output ripple and noise section (EMC Specification).

Output Load Transient Response

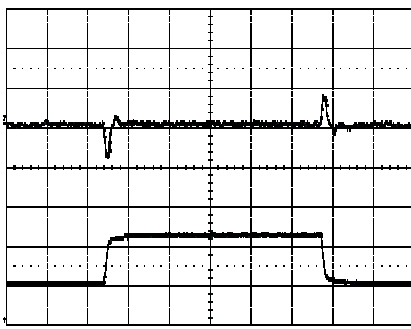

Output voltage response to load current step-change (25-50-25 A) at:
 $T_{ref} = +25^{\circ}\text{C}$, $V_i = 12.0\text{ V}$.

Top trace: output voltage (100 mV/div.).
 Bottom trace: load current (20 A/div.).
 Time scale: 0.2 ms/div.

PMM 8000 series PoL Regulators
 Input 8-14 V, Output 50 A / 275 W

2/ 28701- BMR 651 Rev. A November 2017

© Flex

1.8 V/50 A Electrical Specification
PMM 8218T
 $T_{ref} = -40$ to $+85^{\circ}\text{C}$, $V_I = 8.0$ to 14.0 V, $R_{adj} = 6.34$ k Ω , unless otherwise specified under Conditions.

 Typical values given at: $T_{ref} = +25^{\circ}\text{C}$, $V_I = 12.0$ V, max I_O , unless otherwise specified under Conditions.

 Additional $C_{in} = 1000\mu\text{F}$ and $C_{out} = 660\mu\text{F}$. See Operating Information section for selection of capacitor types.

Connect the sense pin, where available, to the output pin.

Characteristics		Conditions	min	typ	max	Unit
V_I	Input voltage range		8.0		14.0	V
UVLO	Undervoltage lockout	Pin 8 open	On-threshold		14.0	V
			Hysteresis			
C_I	Internal input capacitance			80		μF
P_O	Output power		0		90	W
η	Efficiency	50 % of max I_O	91.1			%
		max I_O	89.0			
P_d	Power Dissipation	max I_O	11.1			W
P_{li}	Input idling power	$I_O = 0$, $V_I = 12.0$ V	1580			mW
P_{inh}	Input standby power	$V_I = 12.0$ V (turned off with INHIBIT)	420			mW
I_S	Static Input current	$V_I = 12.0$ V, max I_O	8.4			A
f_s	Switching frequency	0-100 % of max I_O	900	1050	1200	kHz

V_{O_i}	Output voltage initial setting and accuracy	$T_{ref} = +25^{\circ}\text{C}$, $V_I = 12.0$ V, max I_O	1.764	1.800	1.836	V
V_O	Output voltage tolerance band	10-100 % of max I_O	1.746		1.854	V
	Idling voltage	$I_O = 0$		1.794		V
	Line regulation	max I_O		± 5		mV
	Load regulation	$V_I = 12.0$ V, 0-100% of max I_O		± 5		mV
V_{tr}	Load transient voltage deviation	$V_I = 12.0$ V, Load step 50-100-50 % of max I_O , $di/dt = 1$ A/ μs , see Note 1		± 90		mV
t_{tr}	Load transient recovery time			100		μs
t_r	Ramp-up time (from 10–90 % of V_O)	max I_O		2.3		ms
t_s	Start-up time (from V_I connection to 90% of V_O)				6.3	
t_f	Ramp-down time (from 90–10 % of V_O)	Max I_O		140		μs
		$I_O = 0.1$ A		42.1		ms
t_{inh}	INHIBIT start-up time	Max I_O		5.6		ms
	INHIBIT shutdown fall time (From INHIBIT off to 10% of V_O)	Max I_O		190		μs
		$I_O = 0.1$ A		6.8		ms
I_O	Output current		0		50	A
I_{lim}	Current limit threshold	$T_{ref} < \max T_{ref}$		95		A
V_{Oac}	Output ripple & noise	See ripple & noise section, max I_O , V_{O_i}		15		mVp-p

Note 1: Output filter according to Ripple & Noise section

PMM 8000 series PoL Regulators
 Input 8-14 V, Output 50 A / 275 W

2/ 28701- BMR 651 Rev. A November 2017

© Flex

1.8 V/50 A Typical Characteristics

PMM 8218T

Efficiency

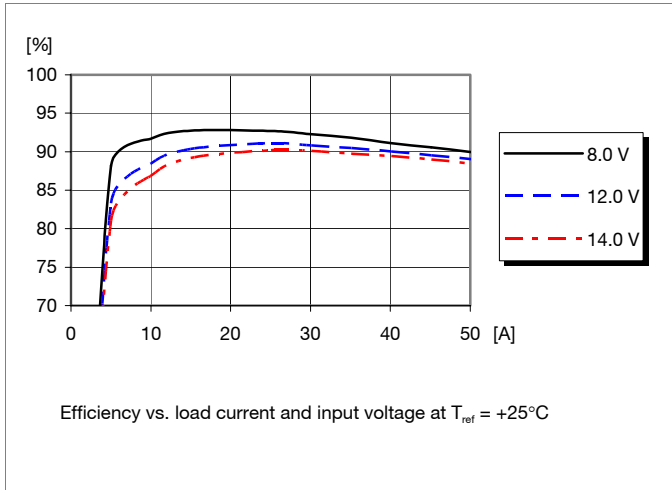

Power Dissipation

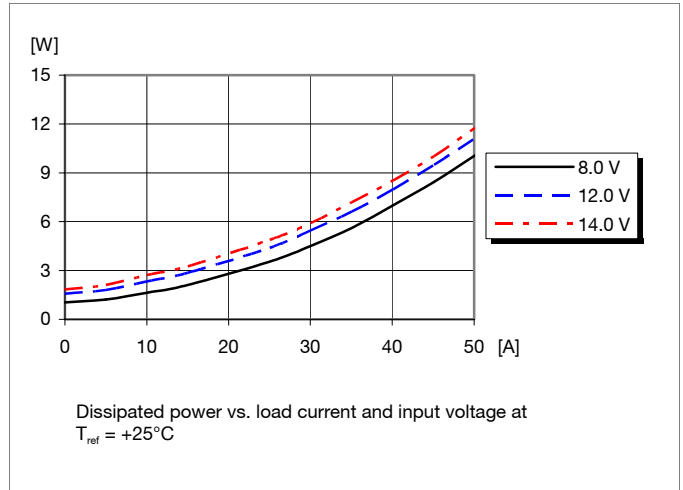

Output Current Derating

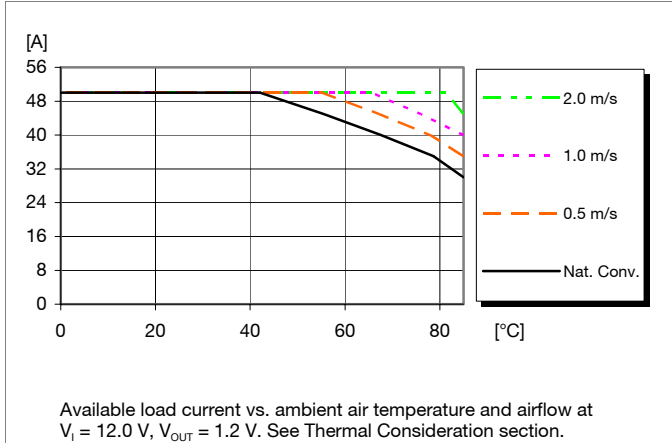

Output Characteristics

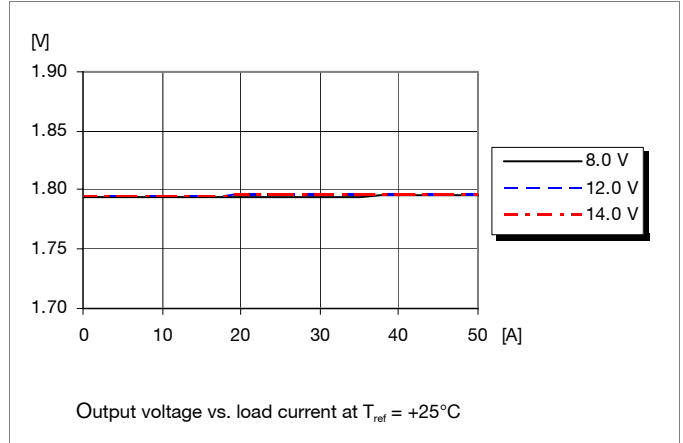

PMM 8000 series PoL Regulators
 Input 8-14 V, Output 50 A / 275 W

2/ 28701- BMR 651 Rev. A November 2017

© Flex

1.8 V/50 A Typical Characteristics

PMM 8218T

Start-up

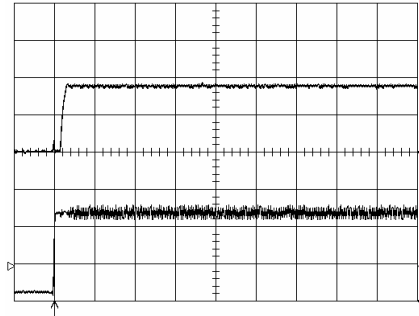

Start-up enabled by connecting V_i at:
 $T_{ref} = +25^\circ\text{C}$, $I_o = 50\text{ A}$ resistive load,
 $V_i = 12.0\text{ V}$.

Top trace: output voltage (1.0 V/div.).
 Bottom trace: input voltage (5 V/div.).
 Time scale: 20 ms/div.

Shut-down

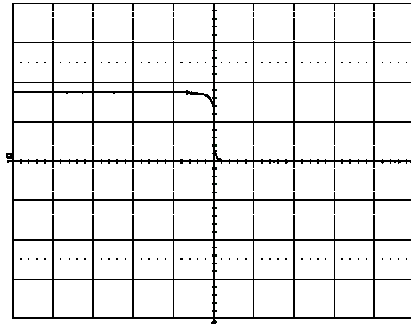

Shut-down enabled by disconnecting V_i at:
 $T_{ref} = +25^\circ\text{C}$, $I_o = 50\text{ A}$ resistive load,
 $V_i = 12.0\text{ V}$.

Top trace: output voltage (1.0 V/div.).
 Time scale: 1.0 ms/div.

Output Ripple & Noise

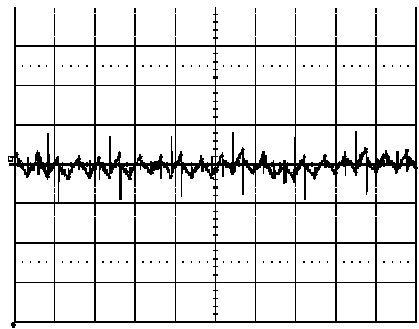

Output voltage ripple (20 mV/div.) at:
 $T_{ref} = +25^\circ\text{C}$, $I_o = 50\text{ A}$ resistive load,
 $V_i = 12.0\text{ V}$. Time scale: 2 μs /div.

See the filter in the Output ripple and noise section (EMC Specification).

Output Load Transient Response

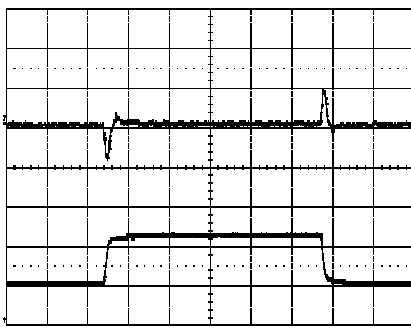

Output voltage response to load current step-change (25-50-25 A) at:
 $T_{ref} = +25^\circ\text{C}$, $V_i = 12.0\text{ V}$.

Top trace: output voltage (100 mV/div.).
 Bottom trace: load current (20 A/div.).
 Time scale: 0.2 ms/div.

PMM 8000 series PoL Regulators
 Input 8-14 V, Output 50 A / 275 W

2/ 28701- BMR 651 Rev. A November 2017

© Flex

2.5 V/50 A Electrical Specification

PMM 8218T

$T_{ref} = -40$ to $+85^{\circ}\text{C}$, $V_I = 8.0$ to 14.0 V, $R_{adj} = 3.01$ k Ω , unless otherwise specified under Conditions.

Typical values given at: $T_{ref} = +25^{\circ}\text{C}$, $V_I = 12.0$ V, max I_O , unless otherwise specified under Conditions.

Additional $C_{in} = 1000\mu\text{F}$ and $C_{out} = 660\mu\text{F}$. See Operating Information section for selection of capacitor types.

Connect the sense pin, where available, to the output pin.

Characteristics		Conditions	min	typ	max	Unit
V_I	Input voltage range		8.0		14.0	V
UVLO	Undervoltage lockout	Pin 8 open	On-threshold		14.0	V
			Hysteresis			
C_I	Internal input capacitance			80		μF
P_O	Output power		0		125	W
η	Efficiency	50 % of max I_O		93.0		%
		max I_O		91.4		
P_d	Power Dissipation	max I_O		11.7		W
P_{li}	Input idling power	$I_O = 0$, $V_I = 12.0$ V		1820		mW
P_{inh}	Input standby power	$V_I = 12.0$ V (turned off with INHIBIT)		420		mW
I_S	Static Input current	$V_I = 12.0$ V, max I_O		11.4		A
f_s	Switching frequency	0-100 % of max I_O	900	1050	1200	kHz

V_{O_i}	Output voltage initial setting and accuracy	$T_{ref} = +25^{\circ}\text{C}$, $V_I = 12.0$ V, max I_O	2.450	2.500	2.550	V
V_O	Output voltage tolerance band	10-100 % of max I_O	2.425		2.575	V
	Idling voltage	$I_O = 0$		2.500		V
	Line regulation	max I_O		± 5		mV
	Load regulation	$V_I = 12.0$ V, 0-100 % of max I_O		± 5		mV
V_{tr}	Load transient voltage deviation	$V_I = 12.0$ V, Load step 50-100-50 % of max I_O , $di/dt = 1$ A/ μs , see Note 1		± 95		mV
t_{tr}	Load transient recovery time			100		μs
t_r	Ramp-up time (from 10-90 % of V_O)	max I_O		2.4		ms
t_s	Start-up time (from V_I connection to 90% of V_O)				6.2	
t_f	Ramp-down time (from 90-10 % of V_O)	Max I_O		150		μs
		$I_O = 0.1$ A		53.6		ms
t_{inh}	INHIBIT start-up time	Max I_O		5.6		ms
	INHIBIT shutdown fall time (From INHIBIT off to 10% of V_O)	Max I_O		120		μs
		$I_O = 0.1$ A		9.1		ms
I_O	Output current		0		50	A
I_{lim}	Current limit threshold	$T_{ref} < \max T_{ref}$		95		A
V_{Oac}	Output ripple & noise	See ripple & noise section, max I_O , V_{O_i}		15		mVp-p

Note 1: Output filter according to Ripple & Noise section

PMM 8000 series PoL Regulators
 Input 8-14 V, Output 50 A / 275 W

2/ 28701- BMR 651 Rev. A November 2017

© Flex

2.5 V/50 A Typical Characteristics

PMM 8218T

Efficiency

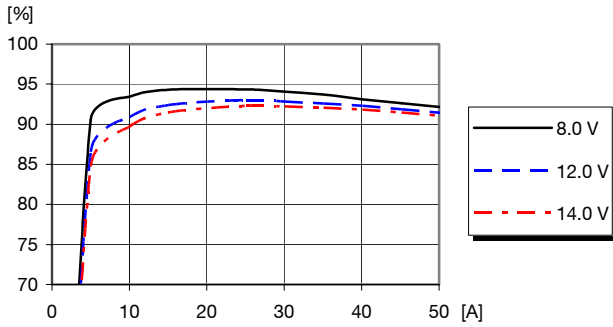

Efficiency vs. load current and input voltage at $T_{ref} = +25^{\circ}\text{C}$

Power Dissipation

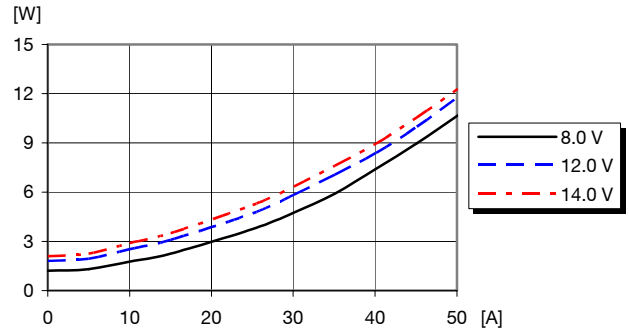

Dissipated power vs. load current and input voltage at $T_{ref} = +25^{\circ}\text{C}$

Output Current Derating

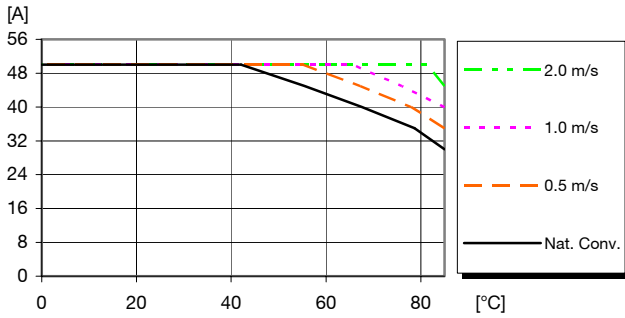

Available load current vs. ambient air temperature and airflow at $V_i = 12.0\text{ V}$, $V_{OUT} = 1.2\text{ V}$. See Thermal Consideration section.

Output Characteristics

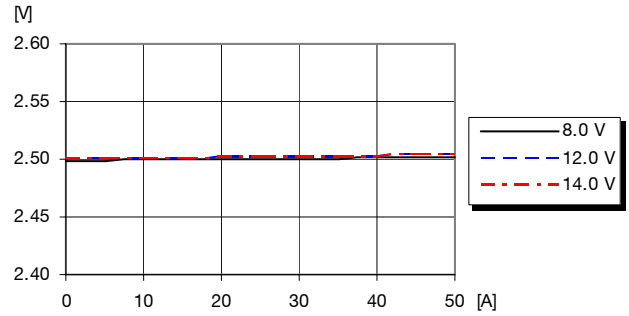

Output voltage vs. load current at $T_{ref} = +25^{\circ}\text{C}$

PMM 8000 series PoL Regulators
 Input 8-14 V, Output 50 A / 275 W

2/ 28701- BMR 651 Rev. A November 2017

© Flex

2.5 V/50 A Typical Characteristics

PMM 8218T

Start-up

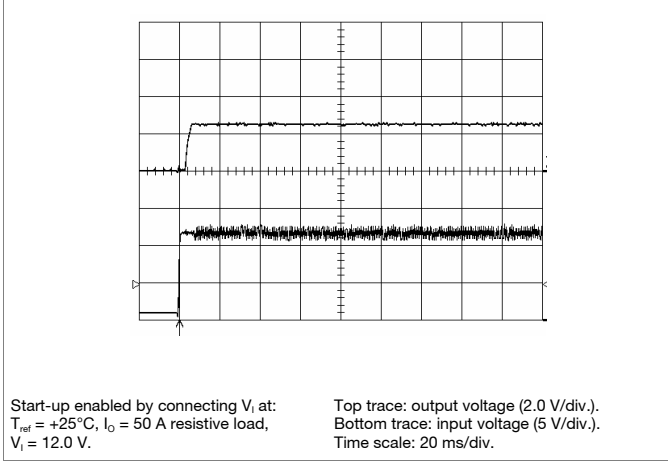

Shut-down

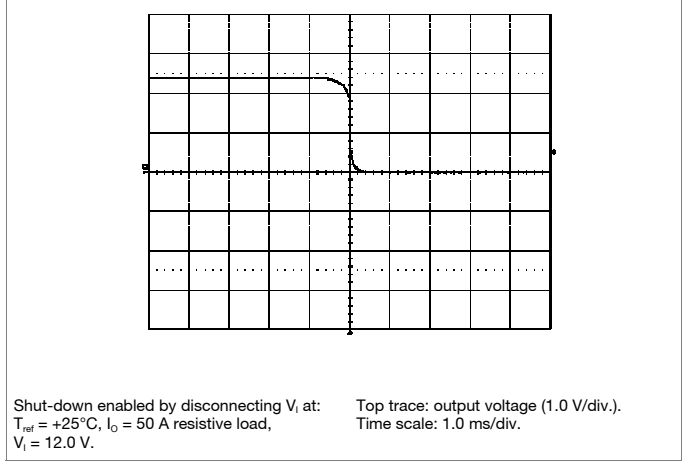

Output Ripple & Noise

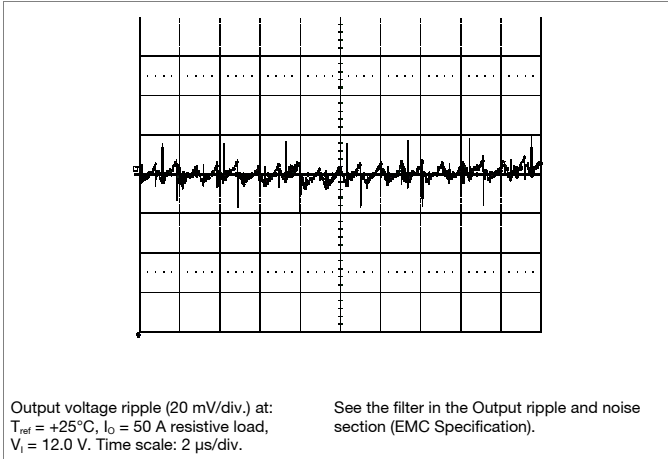

Output Load Transient Response

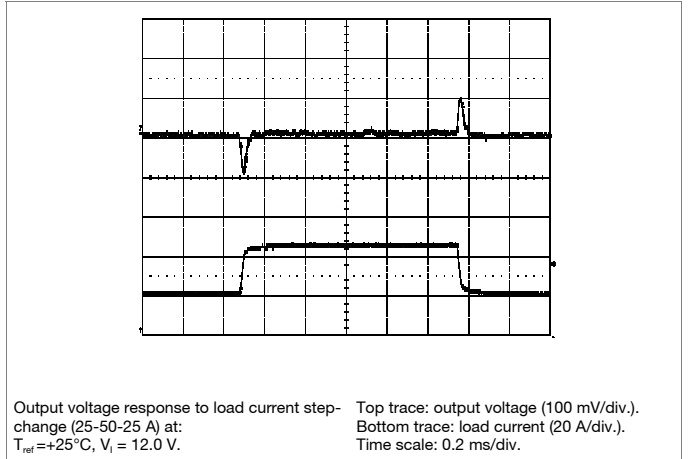

PMM 8000 series PoL Regulators
 Input 8-14 V, Output 50 A / 275 W

2/ 28701- BMR 651 Rev. A November 2017

© Flex

3.3 V/50 A Electrical Specification
PMM 8218T
 $T_{ref} = -40$ to $+85^{\circ}\text{C}$, $V_I = 8.0$ to 14.0 V, $R_{adj} = 1.50$ k Ω , unless otherwise specified under Conditions.

 Typical values given at: $T_{ref} = +25^{\circ}\text{C}$, $V_I = 12.0$ V, max I_O , unless otherwise specified under Conditions.

 Additional $C_{in} = 1000\mu\text{F}$ and $C_{out} = 660\mu\text{F}$. See Operating Information section for selection of capacitor types.

Connect the sense pin, where available, to the output pin.

Characteristics		Conditions	min	typ	max	Unit
V_I	Input voltage range		8.0		14.0	V
UVLO	Undervoltage lockout	Pin 8 open	On-threshold		7.5	V
			Hysteresis		1	
C_I	Internal input capacitance			80		μF
P_O	Output power		0		165	W
η	Efficiency	50 % of max I_O		94.3		%
		max I_O		93.0		
P_d	Power Dissipation	max I_O		12.4		W
P_{li}	Input idling power	$I_O = 0$, $V_I = 12.0$ V		2070		mW
P_{inh}	Input standby power	$V_I = 12.0$ V (turned off with INHIBIT)		420		mW
I_S	Static Input current	$V_I = 12.0$ V, max I_O		14.9		A
f_s	Switching frequency	0-100 % of max I_O	900	1050	1200	kHz

V_{O_i}	Output voltage initial setting and accuracy	$T_{ref} = +25^{\circ}\text{C}$, $V_I = 12.0$ V, max I_O	3.234	3.300	3.366	V
V_O	Output voltage tolerance band	10-100 % of max I_O	3.201		3.399	V
	Idling voltage	$I_O = 0$		3.305		V
	Line regulation	max I_O		± 5		mV
	Load regulation	$V_I = 12.0$ V, 0-100 % of max I_O		± 5		mV
V_{tr}	Load transient voltage deviation	$V_I = 12.0$ V, Load step 50-100-50 % of max I_O , $di/dt = 1$ A/ μs , see Note 1		± 130		mV
t_{tr}	Load transient recovery time			150		μs
t_r	Ramp-up time (from 10–90 % of V_O)	max I_O		2.3		ms
t_s	Start-up time (from V_I connection to 90% of V_O)			6.3		ms
t_f	Ramp-down time (from 90–10 % of V_O)	Max I_O		200		μs
		$I_O = 0.1$ A		66.5		ms
t_{inh}	INHIBIT start-up time	Max I_O		5.6		ms
	INHIBIT shutdown fall time (From INHIBIT off to 10% of V_O)	Max I_O		130		μs
		$I_O = 0.1$ A		11.7		ms
I_O	Output current		0		50	A
I_{lim}	Current limit threshold	$T_{ref} < \max T_{ref}$		95		A
V_{Oac}	Output ripple & noise	See ripple & noise section, max I_O , V_{O_i}		15		mVp-p

Note 1: Output filter according to Ripple & Noise section

PMM 8000 series PoL Regulators
Input 8-14 V, Output 50 A / 275 W

2/ 28701- BMR 651 Rev. A November 2017
© Flex

3.3 V/50 A Typical Characteristics

PMM 8218T

Efficiency

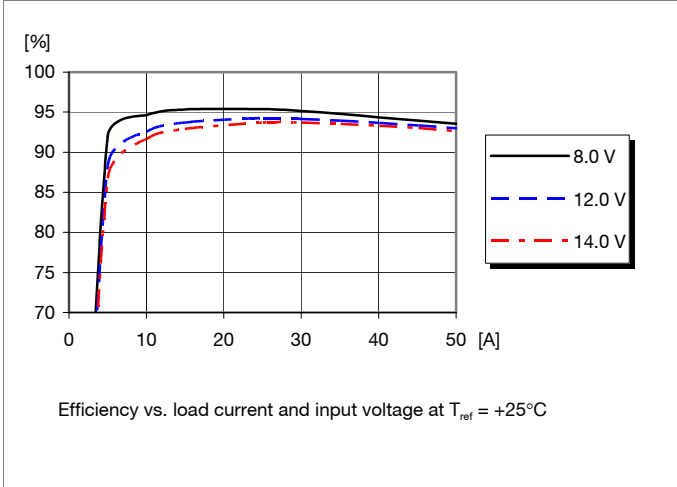

Power Dissipation

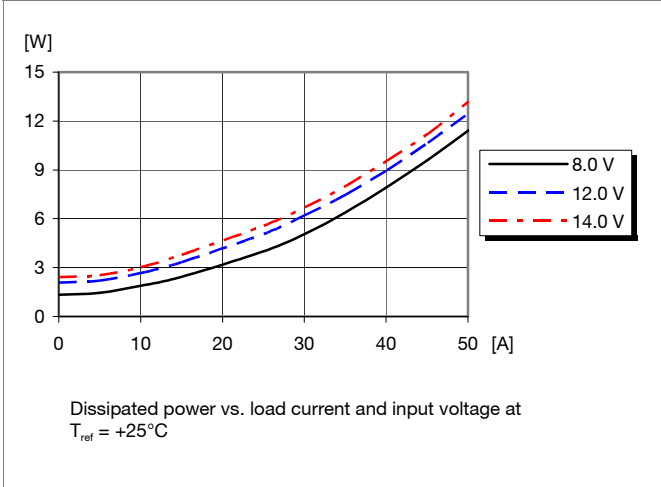

Output Current Derating

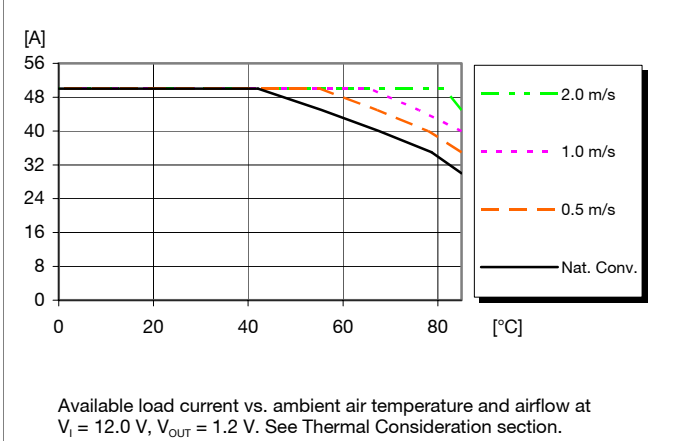

Output Characteristics

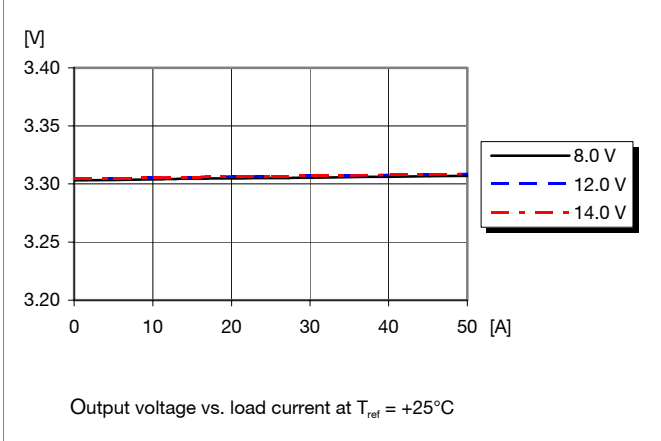

PMM 8000 series PoL Regulators
 Input 8-14 V, Output 50 A / 275 W

2/ 28701- BMR 651 Rev. A November 2017

© Flex

3.3 V/50 A Typical Characteristics

PMM 8218T

Start-up

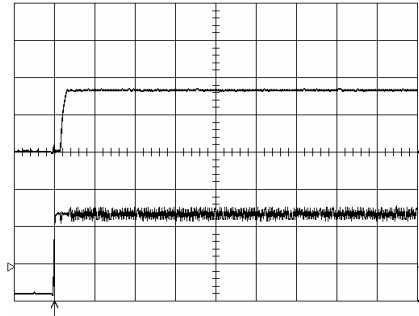

Start-up enabled by connecting V_i at:
 $T_{ref} = +25^{\circ}C$, $I_o = 50$ A resistive load,
 $V_i = 12.0$ V.

Top trace: output voltage (2.0 V/div.).
 Bottom trace: input voltage (5 V/div.).
 Time scale: 20 ms/div.

Shut-down

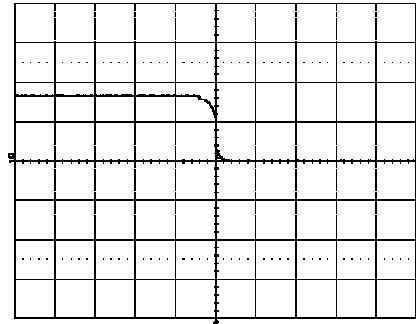

Shut-down enabled by disconnecting V_i at:
 $T_{ref} = +25^{\circ}C$, $I_o = 50$ A resistive load,
 $V_i = 12.0$ V.

Top trace: output voltage (2.0 V/div.).
 Time scale: 1.0 ms/div.

Output Ripple & Noise

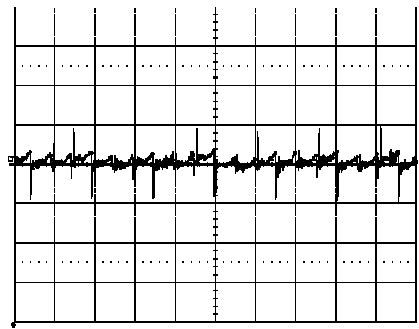

Output voltage ripple (20 mV/div.) at:
 $T_{ref} = +25^{\circ}C$, $I_o = 50$ A resistive load,
 $V_i = 12.0$ V. Time scale: 2 μ s/div.

See the filter in the Output ripple and noise section (EMC Specification).

Output Load Transient Response

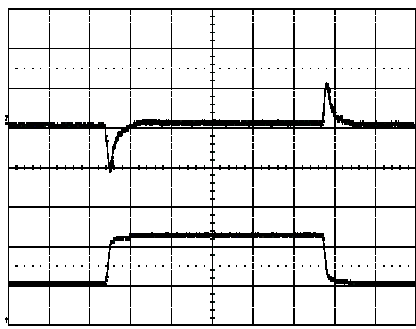

Output voltage response to load current step-change (25-50-25 A) at:
 $T_{ref} = +25^{\circ}C$, $V_i = 12.0$ V.

Top trace: output voltage (100 mV/div.).
 Bottom trace: load current (20 A/div.).
 Time scale: 0.2 ms/div.

PMM 8000 series PoL Regulators
 Input 8-14 V, Output 50 A / 275 W

2/ 28701- BMR 651 Rev. A November 2017

© Flex

5.0 V/50 A Electrical Specification

PMM 8218T

$T_{ref} = -40$ to $+85^{\circ}\text{C}$, $V_I = 8.0$ to 14.0 V, $R_{adj} = 205 \Omega$, unless otherwise specified under Conditions.

Typical values given at: $T_{ref} = +25^{\circ}\text{C}$, $V_I = 12.0$ V, max I_O , unless otherwise specified under Conditions.

Additional $C_{in} = 1000\mu\text{F}$ and $C_{out} = 660\mu\text{F}$. See Operating Information section for selection of capacitor types.

Connect the sense pin, where available, to the output pin.

Characteristics		Conditions	min	typ	max	Unit
V_I	Input voltage range		8.0		14.0	V
UVLO	Undervoltage lockout	Pin 8 open	On-threshold		7.5	V
			Hysteresis		1	
C_I	Internal input capacitance			80		μF
P_O	Output power		0		250	W
η	Efficiency	50 % of max I_O		95.7		%
		max I_O		94.8		
P_d	Power Dissipation	max I_O		13.9		W
P_{li}	Input idling power	$I_O = 0$, $V_I = 12.0$ V		2510		mW
P_{inh}	Input standby power	$V_I = 12.0$ V (turned off with INHIBIT)		420		mW
I_S	Static Input current	$V_I = 12.0$ V, max I_O		22.1		A
f_s	Switching frequency	0-100 % of max I_O	900	1050	1200	kHz

V_{O_i}	Output voltage initial setting and accuracy	$T_{ref} = +25^{\circ}\text{C}$, $V_I = 12.0$ V, max I_O	4.900	5.000	5.100	V
V_O	Output voltage tolerance band	10-100 % of max I_O	4.850		5.150	V
	Idling voltage	$I_O = 0$		5.018		V
	Line regulation	max I_O		± 5		mV
	Load regulation	$V_I = 12.0$ V, 0-100 % of max I_O		± 5		mV
V_{tr}	Load transient voltage deviation	$V_I = 12.0$ V, Load step 50-100-50 % of max I_O , $di/dt = 1$ A/ μ s, see Note 1		± 140		mV
t_{tr}	Load transient recovery time			150		μs
t_r	Ramp-up time (from 10-90 % of V_O)	max I_O		2.4		ms
t_s	Start-up time (from V_I connection to 90% of V_O)				6.3	
t_f	Ramp-down time (from 90-10 % of V_O)	Max I_O		260		μs
		$I_O = 0.1$ A		91.9		ms
t_{inh}	INHIBIT start-up time	Max I_O		5.6		ms
	INHIBIT shutdown fall time (From INHIBIT off to 10% of V_O)	Max I_O		220		μs
		$I_O = 0.1$ A		16.7		ms
I_O	Output current		0		50	A
I_{lim}	Current limit threshold	$T_{ref} < \max T_{ref}$		95		A
V_{Oac}	Output ripple & noise	See ripple & noise section, max I_O , V_{O_i}		15		mVp-p

Note 1: Output filter according to Ripple & Noise section

PMM 8000 series PoL Regulators
 Input 8-14 V, Output 50 A / 275 W

2/ 28701- BMR 651 Rev. A November 2017

© Flex

5.0 V/50 A Typical Characteristics

PMM 8218T

Efficiency

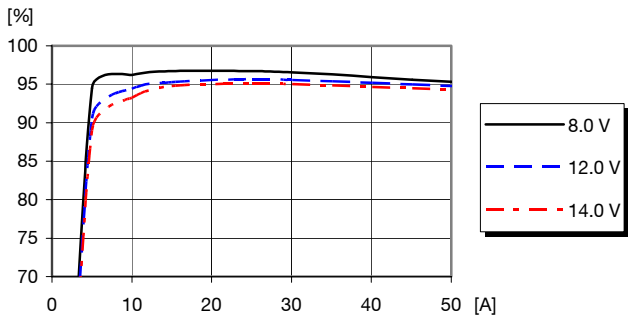

Efficiency vs. load current and input voltage at $T_{ref} = +25^{\circ}\text{C}$

Power Dissipation

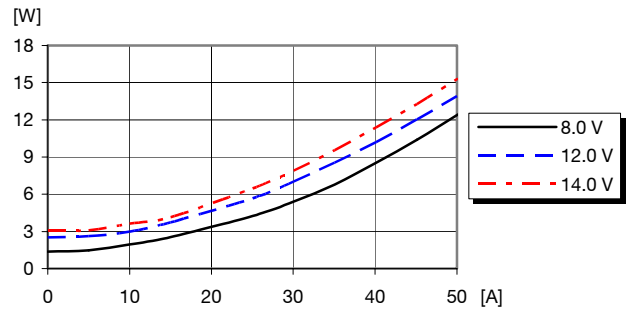

Dissipated power vs. load current and input voltage at $T_{ref} = +25^{\circ}\text{C}$

Output Current Derating

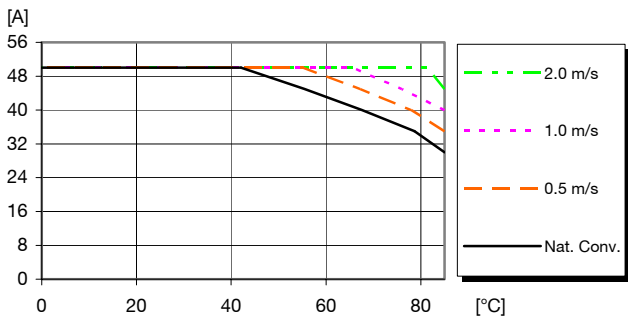

Available load current vs. ambient air temperature and airflow at $V_I = 12.0\text{ V}$, $V_{OUT} = 1.2\text{ V}$. See Thermal Consideration section.

Output Characteristics

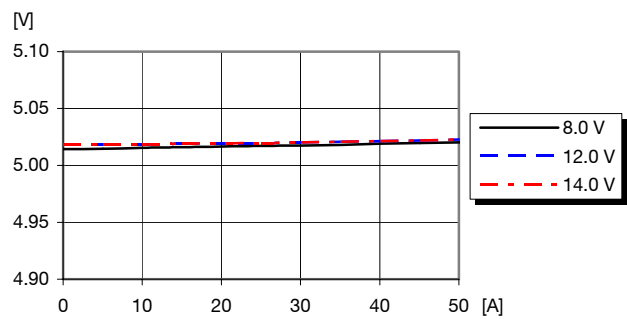

Output voltage vs. load current at $T_{ref} = +25^{\circ}\text{C}$

PMM 8000 series PoL Regulators
 Input 8-14 V, Output 50 A / 275 W

2/ 28701- BMR 651 Rev. A November 2017

© Flex

5.0 V/50 A Typical Characteristics

PMM 8218T

Start-up

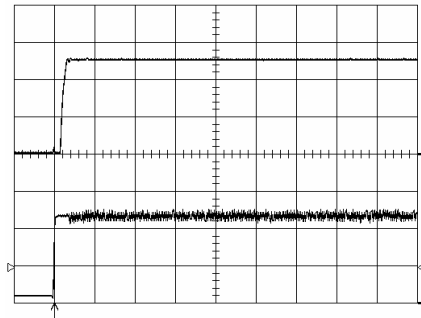

Start-up enabled by connecting V_i at:
 $T_{ref} = +25^\circ\text{C}$, $I_o = 50\text{ A}$ resistive load,
 $V_i = 12.0\text{ V}$.

Top trace: output voltage (2.0 V/div.).
 Bottom trace: input voltage (5 V/div.).
 Time scale: 20 ms/div.

Shut-down

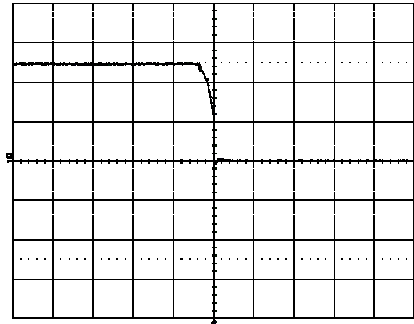

Shut-down enabled by disconnecting V_i at:
 $T_{ref} = +25^\circ\text{C}$, $I_o = 50\text{ A}$ resistive load,
 $V_i = 12.0\text{ V}$.

Top trace: output voltage (2.0 V/div.).
 Time scale: 1.0 ms/div.

Output Ripple & Noise

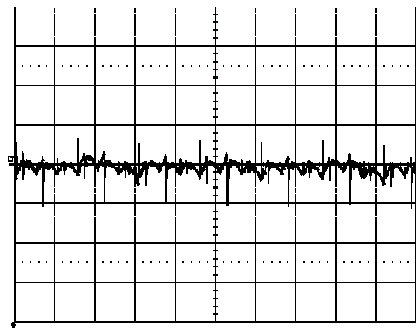

Output voltage ripple (20 mV/div.) at:
 $T_{ref} = +25^\circ\text{C}$, $I_o = 50\text{ A}$ resistive load,
 $V_i = 12.0\text{ V}$. Time scale: 2 μs /div.

See the filter in the Output ripple and noise section (EMC Specification).

Output Load Transient Response

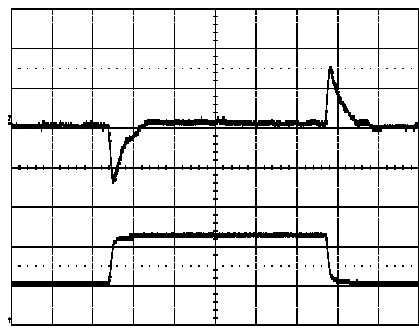

Output voltage response to load current step-change (25-50-25 A) at:
 $T_{ref} = +25^\circ\text{C}$, $V_i = 12.0\text{ V}$.

Top trace: output voltage (100 mV/div.).
 Bottom trace: load current (20 A/div.).
 Time scale: 0.2 ms/div.

PMM 8000 series PoL Regulators
 Input 8-14 V, Output 50 A / 275 W

2/ 28701- BMR 651 Rev. A November 2017
 © Flex

EMC Specification

Conducted EMI measured according to test set-up.
 The fundamental switching frequency is 1050 kHz for PMM 8218T @ $V_I = 12 V$, max I_o .

Conducted EMI Input terminal value (typ)

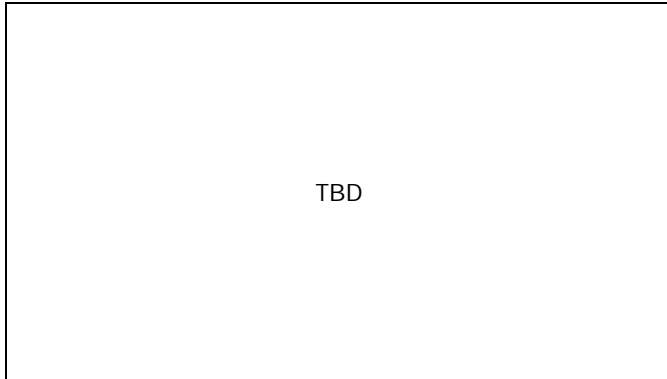

EMI without filter

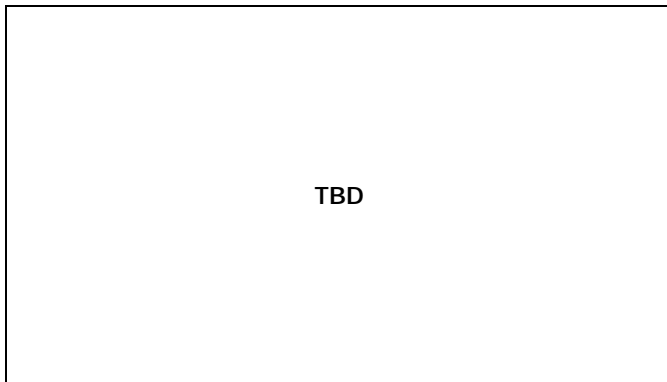

Test set-up

Layout recommendation

The radiated EMI performance of the POL regulator will depend on the PCB layout and ground layer design. It is also important to consider the stand-off of the POL regulator. If a ground layer is used, it should be connected to the output of the POL regulator and the equipment ground or chassis.

A ground layer will increase the stray capacitance in the PCB and improve the high frequency EMC performance.

Output ripple and noise

Output ripple and noise measured according to figure below. See Design Note 022 for detailed information.

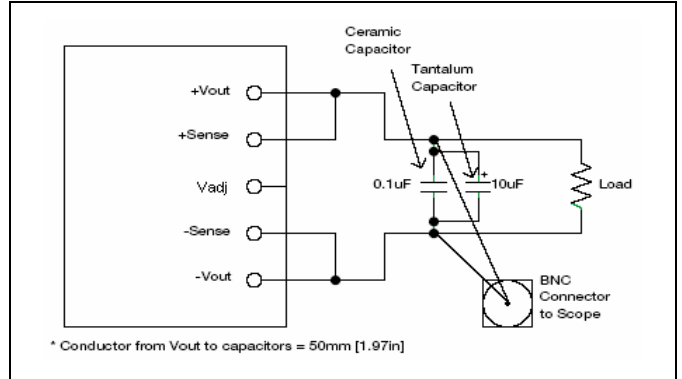

Output ripple and noise test setup

Operating information

Extended information for POLA products is found in Application Note POLA(AN205).

Input Voltage

The input voltage range 8.0 to 14.0Vdc makes the product easy to use in intermediate bus applications when powered by a regulated 12V bus converter. The PMM product family is also available with 3.3 or 5.0 V_{in} .

Turn on/off Input Voltage

The POL regulators monitor the input voltage and will turn on and turn off at predetermined levels. The typical hysteresis between turn on and turn off input voltage is 1V.

Inhibit Control (INH)

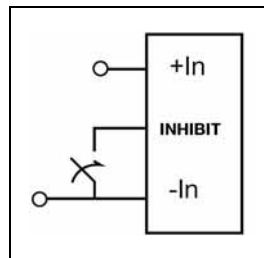

The products are equipped with an Inhibit control function referenced to the primary negative input connection (- In), positive logic. The INHIBIT function allows the regulator to be turned on/off by an external device like a semiconductor or mechanical switch.

The regulator will turn on when the input voltage is applied with the INHIBIT pin open. Turn off is achieved by connecting the INHIBIT pin to the - In. To ensure safe turn off, the voltage difference between INHIBIT pin and the - In pin shall be less than 0.5V. The regulator will restart automatically when this connection is opened.

PMM 8000 series PoL Regulators
Input 8-14 V, Output 50 A / 275 W

2/ 28701- BMR 651 Rev. A November 2017

© Flex

External Capacitors

Input capacitors:

The recommended input capacitors are determined by the 560 μF minimum capacitance and 300 mArms minimum ripple current rating. For high performance applications, or wherever the transient capability of the input source is limited, 1000 μF of input capacitance is recommended.

Output capacitors (optional):

The recommended output capacitance of 660 μF will allow the module to meet its transient response specification as defined in the electrical specification.

When using one or more non-ceramic capacitors, the calculated equivalent ESR should be no lower than 4 m Ω (7m Ω using the manufacturer's maximum ESR for a single capacitor).

Input And Output Impedance

The impedance of both the input source and the load will interact with the impedance of the POL regulator. It is important that the input source has low characteristic impedance. The regulators are designed for stable operation without external capacitors connected to the input or output. The performance in some applications can be enhanced by addition of external capacitance as described under External Decoupling Capacitors. If the input voltage source contains significant inductance, the addition of a 100 μF capacitor across the input of the regulator will ensure stable operation. The capacitor is not required when powering the POL regulator from an input source with an inductance below 10 μH .

External Decoupling Capacitors

When powering loads with significant dynamic current requirements, the voltage regulation at the point of load can be improved by addition of decoupling capacitors at the load. The most effective technique is to locate low ESR ceramic and electrolytic capacitors as close to the load as possible, using several parallel capacitors to lower the effective ESR. The ceramic capacitors will handle high-frequency dynamic load changes while the electrolytic capacitors are used to handle low frequency dynamic load changes. Ceramic capacitors will also reduce any high frequency noise at the load.

It is equally important to use low resistance and low inductance PCB layouts and cabling.

External decoupling capacitors will become part of the control loop of the POL regulator and may affect the stability margins. As a "rule of thumb", 100 $\mu\text{F}/\text{A}$ of output current can be added without any additional analysis. The ESR of the capacitors is a very important parameter. Power Modules guarantee stable operation with a verified ESR value of >10 m Ω across the output connections.

For further information please contact your local Flex representative.

Output Voltage Adjust (V_{adj})

The output voltage can be set by means of an external resistor, connected to the V_{adj} pin. Nominal output voltage 0.8 V is set by leaving the V_{adj} pin open. Adjustment can only be made to increase the output voltage setting.

To increase the voltage a resistor should be connected between the V_{adj} pin and GND pin. The resistor value of the Output voltage adjust function is according to information given under the Output section for the respective product.

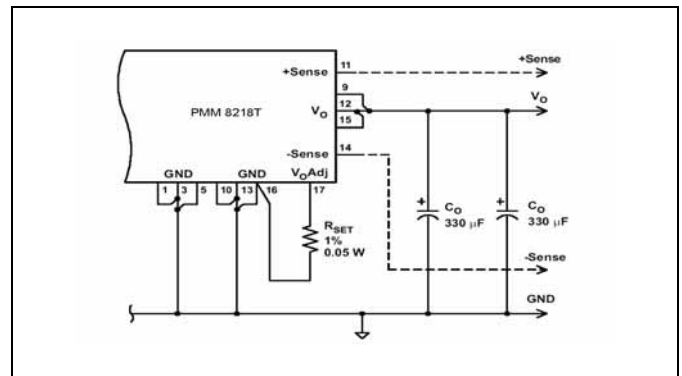

UVLO Adjustment

The UVLO feature of the PMM family module allows for limited adjustment of both the on threshold and hysteresis voltages. The adjustment is made via the UVLO Prog control pin. When the UVLO Prog pin is left open circuit, the on threshold and hysteresis voltages are internally set to their default values. The on threshold has a nominal voltage of 7.5 V, and the hysteresis 1 V. This ensures that the module produces a regulated output when the minimum input voltage is applied. The combination correlates to an off threshold of approximately 6.5 V. The adjustments are limited. The on threshold can only be adjusted higher, and the hysteresis voltage can only be reduced in magnitude.

Parallel Operation

Two POL regulators may be paralleled for redundancy if the total power is equal or less than $P_{\text{O max}}$. It is not recommended to parallel the POL regulators without using external current sharing circuits.

Remote Sense

The POL regulators have remote sense that can be used to compensate for voltage drops between the output and the point of load. The sense traces should be located close to the PCB ground layer to reduce noise susceptibility. The remote sense circuitry will compensate for up to 0.3v voltage drop between output pins and the point of load.

If the remote sense is not needed +Sense and -Sense should be left open.

PMM 8000 series PoL Regulators

Input 8-14 V, Output 50 A / 275 W

2/ 28701- BMR 651 Rev. A November 2017

© Flex

Over Temperature Protection (OTP)

The PMM family of POL regulators are protected from thermal overload by an internal over temperature shutdown circuit. When the internal temperature exceeds the OTP threshold, the POL regulator will shut down. The POL regulator will make continuous attempts to start up (soft-start mode) and resume normal operation automatically when the temperature has dropped $>10^{\circ}\text{C}$ below the temperature threshold.

Over Current Protection (OCP)

The POL regulators include current limiting circuitry for protection at continuous overload. The output voltage will decrease towards zero for output currents in excess of the over-current threshold. The regulator will resume normal operation after removal of the overload. The load distribution should be designed for the maximum output short circuit current specified. The current limit operation is a "hick up" mode current limit.

Soft-start Power Up

From the moment a valid input voltage is applied, the soft-start control introduces a short time-delay (typically 8-15 ms) before allowing the output voltage to rise. The initial rise in input current when the input voltage first starts to rise is the charge current drawn by the input capacitors. Power-up is complete within 25 ms.

Auto-Track™ Function

The AutoTrack function is designed so that 2 or more POL regulators can track each others output voltage tightly together. This can be accomplished by connection the AutoTrack pin to the output of another POL regulator or by feeding an external voltage ramp on the pin. The AutoTrack will automatically track any external voltage that is applied within the given rules in Application Note POLA (AN205).

Margin Up/Down controls

The margin control allows the input voltage to be momentarily adjusted, either up or down, by a nominal 5 %. This provides a convenient method for dynamically testing the operation of the load circuit over its supply margin or range. It can also be used to verify the function of supply voltage supervisors.

Pre-Bias Startup Capability

This often occurs in complex digital systems when current from another power source is backfed through a dual-supply logic component, such as FPGA or ASIC. The PMM family incorporate synchronous rectifiers, but will not sink current during startup, or whenever the Inhibit pin is held low. However, to ensure satisfactory operation of this function, certain conditions must be maintained.

Thermal Consideration

General

The POL regulators are designed to operate in different thermal environments and sufficient cooling must be provided to ensure reliable operation. Cooling is achieved mainly by conduction, from the pins to the host board, and convection, which is dependant on the airflow across the regulator. Increased airflow enhances the cooling of the POL regulator.

The Output Current Derating graph found in the Output section for each model provides the available output current vs. ambient air temperature and air velocity at $V_{in} = 12\text{ V}$.

The POL regulator is tested on a 254 x 254 mm, 35 μm (1 oz), 8-layer test board mounted vertically in a wind tunnel with a cross-section of 305 x 305 mm.

Proper cooling of the POL regulator can be verified by measuring the temperature at positions P1, P2 and P3. The temperature at these positions should not exceed the max values provided in the table below.

Note that the max value is the absolute maximum rating (non destruction) and that the electrical Output data is guaranteed up to $T_{amb} + 85^{\circ}\text{C}$.

See Design Note 019 for further information.

Position	Device	Designation	max value
P ₁	Pcb		130° C
P ₂	Mosfet	T _{ref}	130° C
P ₃	Inductor		130° C

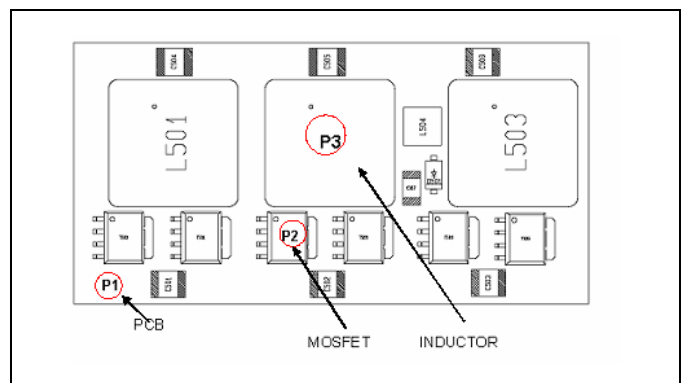

PMM 8000 series PoL Regulators
 Input 8-14 V, Output 50 A / 275 W

2/ 28701- BMR 651 Rev. A November 2017
 © Flex

Thermal Consideration continued

Definition of reference temperature (T_{ref})

The reference temperature is used to monitor the temperature limits of the product. Temperatures above maximum T_{ref} are not allowed and may cause degradation or permanent damage to the product. T_{ref} is also used to define the temperature range for normal operating conditions. T_{ref} is defined by the design and used to guarantee safety margins, proper operation and high reliability of the module.

Ambient Temperature Calculation

TBD

Connections

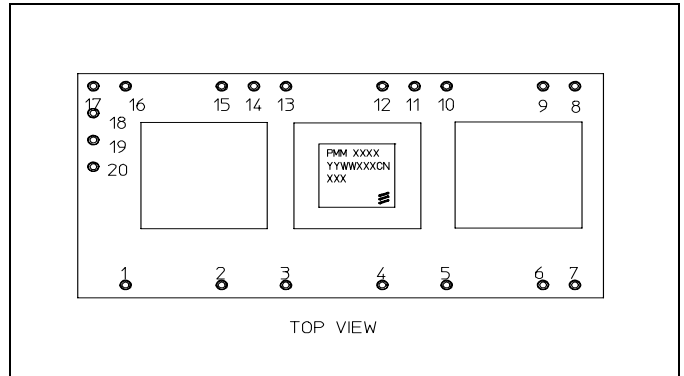

Pin	Designation	Function
1, 3, 5,10, 13,16	GND	Common ground connection for the V_{in} and V_{out} power connections.
2, 4, 6	V_{in}	The positive input voltage power node to the module.
7	Inhibit	Applying a low-level ground signal to this input disables the module's output.
8	UVLO Prog	Connecting a resistor from this pin to ground allows the on threshold of the input undervoltage lockout (UVLO) to be adjusted higher than the default value.
9, 12 ,15	V_{out}	The regulated positive power output with respect to the GND node.
11	+Sense	The sense input allows the regulation circuit to compensate for voltage drop between the module and the load. If used, it should be connected to V_o .
14	-Sense	If used, -Sense should be connected to the ground return at the load.
17	V_o Adjust	A 0.05 W 1% resistor must be directly connected between this pin and GND to set the output voltage.
18	Track	This is an analog control input that enables the output voltage to follow an external voltage.
19	Margin Up	When this input is asserted to GND, the output voltage is increased by 5%.
20	Margin Down	When this input is asserted to GND, the output voltage is decreased by 5% from the nominal.

PMM 8000 series PoL Regulators
 Input 8-14 V, Output 50 A / 275 W

2/ 28701- BMR 651 Rev. A November 2017

© Flex

Mechanical Information (Surface mount version)

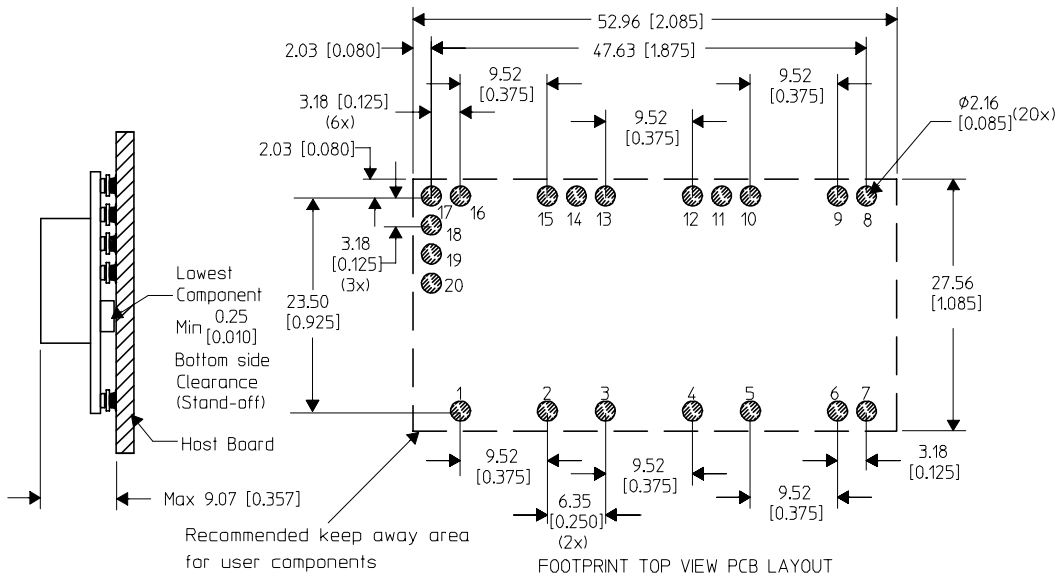
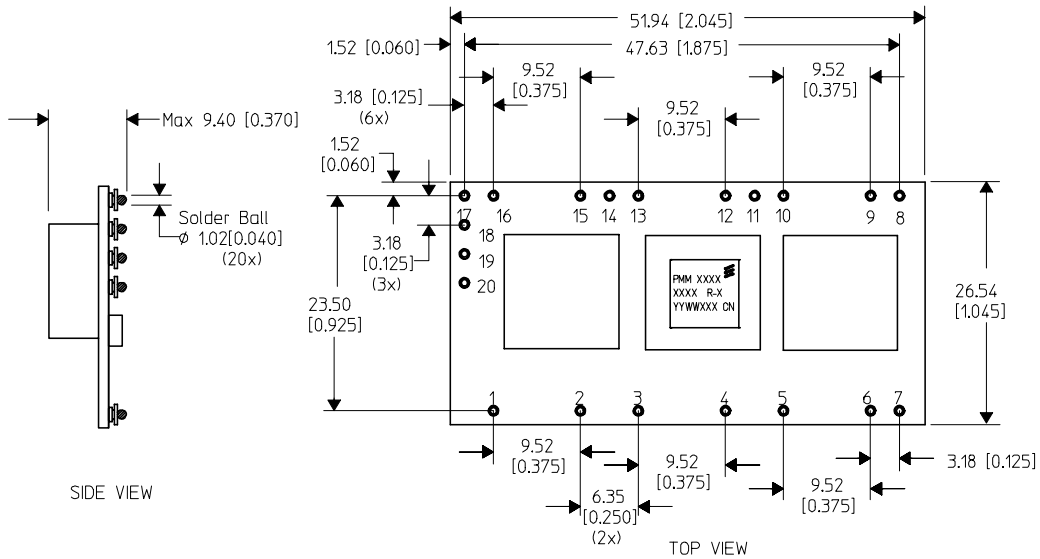

- NOTES:
- A. All linear dimensions are in mm [inch].
 - B. This drawing is subject to change without notice.
 - C. 1 place decimals are ± 0.76 [± 0.030].
 - D. 2 place decimals are ± 0.25 [± 0.010].
 - E. Recommended keep out area for user components.
 - F. Power pin connection should utilize four or more vias to the interior power plane of 0.64 [0.025] I.D. per input, ground and output pin (or the electrical equivalent).

- G. Paste screen opening: 2.03 [0.080] to 2.16 [0.085].
 Paste screen thickness: 0.15 [0.006].
 - H. Pad type: Solder mask defined.
 - I. All pins: Material - Copper Alloy
 Plating - 10µm Tin over 4µm Nickel
 Solder Ball - See product data sheet.
 - J. Dimension prior to reflow solder.
- Weight : 16.8 g

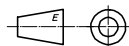

Use recommended footprint and solder recommendations together with solder reflow recommendation to ensure a reliable interconnection.

PMM 8000 series PoL Regulators
 Input 8-14 V, Output 50 A / 275 W

2/ 28701- BMR 651 Rev. A November 2017

© Flex

Mechanical Information (Through hole mount version)

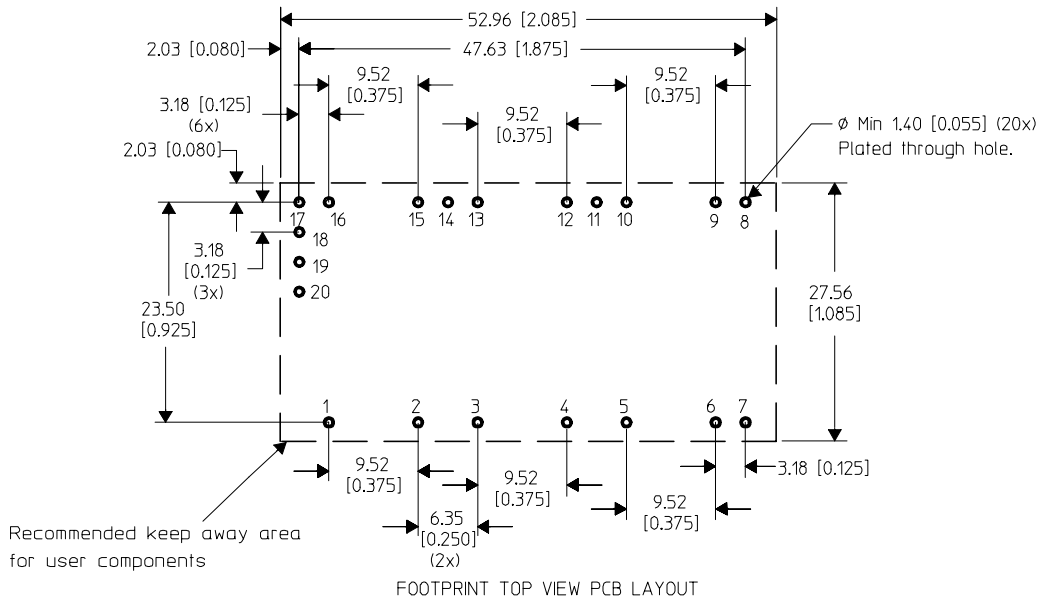
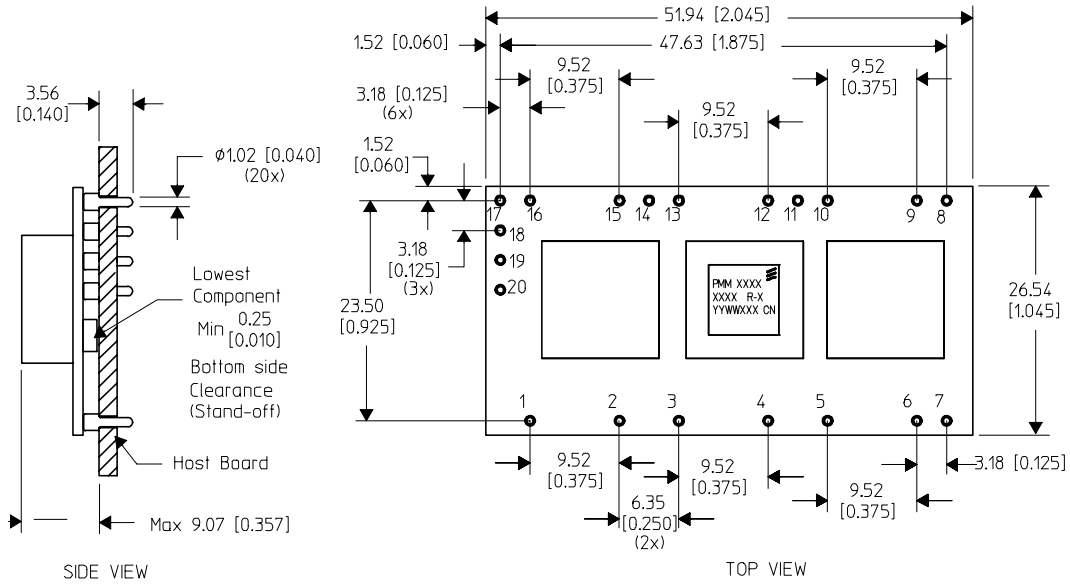

- NOTES:
- A. All linear dimensions are in mm [inch].
 - B. This drawing is subject to change without notice.
 - C. 1 place decimals are ± 0.76 [±0.030].
 - D. 2 place decimals are ± 0.25 [±0.010].
 - E. Recommended keep out area for user components.

- F. Pins are 1.02 [0.040] diameter with 1.78 [0.070] diameter standoff shoulder.
 - G. All pins: Material - Copper Alloy
 Plating - 10µm Tin over 4µm Nickel
- Weight : 17.6 g



Use recommended footprint and solder recommendations together with solder reflow recommendation to ensure a reliable interconnection.

PMM 8000 series PoL Regulators
 Input 8-14 V, Output 50 A / 275 W

2/ 28701- BMR 651 Rev. A November 2017

© Flex

Soldering Information - Surface mounting

The surface mount version of product is intended for convection or vapor phase reflow Pb-free processes. To achieve a good and reliable soldering result, make sure to follow the recommendations from the solder paste supplier, to use state-of-the-art reflow equipment and reflow profiling techniques as well as the following guidelines.

A no-clean flux is recommended to avoid entrapment of cleaning fluids in cavities inside of the DC/DC regulator. The cleaning residues may affect long time reliability and isolation voltage.

Minimum pin temperature recommendations

Pin number 12 is recommended as reference location for the minimum pin temperature recommendations since this will be the coolest solder joint during the reflow process.

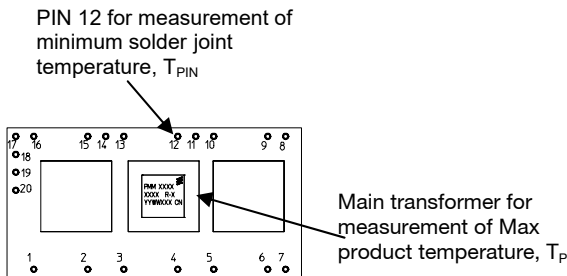

SnPb solder processes

For Pb solder processes, a pin temperature (T_{PIN}) in excess of the solder melting temperature, (T_L , +183 °C for Sn63/Pb37) for more than 30 seconds, and a peak temperature of +210 °C is recommended to ensure a reliable solder joint.

Lead-free (Pb-free) solder processes

For Pb-free solder processes, a pin temperature (T_{PIN}) in excess of the solder melting temperature (T_L , +217 to +221 °C for Sn/Ag/Cu solder alloys) for more than 30 seconds, and a peak temperature of +235 °C on all solder joints is recommended to ensure a reliable solder joint.

Maximum regulator temperature requirements

To avoid damage or performance degradation of the product, the reflow profile should be optimized to avoid excessive heating. The maximum product temperature shall be monitored by attaching a thermal coupler to the top of the main transformer.

A sufficiently extended preheat time is recommended to ensure an even temperature across the host PCB, for both small and large devices. To reduce the risk of excessive heating is also recommended to reduce the time in the reflow zone as much as possible.

SnPb solder processes

For conventional SnPb solder processes, the product is qualified for MSL 1 according to IPC/JEDEC standard J-STD-020C.

During reflow, T_P must not exceed +225 °C at any time.

Lead-free (Pb-free) solder processes

For Pb-free solder processes, the product is qualified for MSL 3 according to IPC/JEDEC standard J-STD-020C.

During reflow, T_P must not exceed +260 °C at any time.

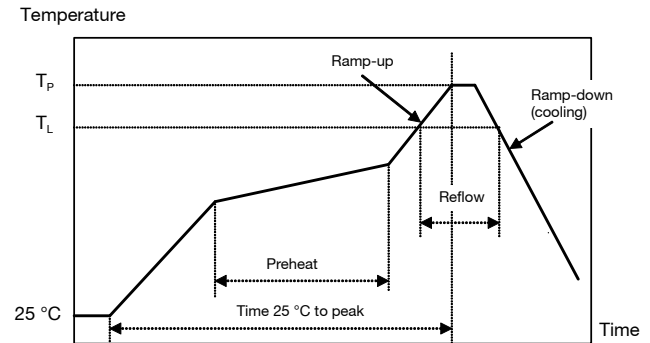

Profile features		Sn/Pb eutectic assembly	Pb-free assembly
Average ramp-up rate		3 °C/s max	3 °C/s max
Solder melting temperature (typical)	T_L	+183 °C	+221 °C
Peak converter temperature	T_P	+225 °C	+260 °C
Average ramp-down rate		6 °C/s max	6 °C/s max
Time 25 °C to peak temperature		6 minutes max	8 minutes max

PMM 8000 series PoL Regulators
 Input 8-14 V, Output 50 A / 275 W

2/ 28701- BMR 651 Rev. A November 2017

© Flex

Soldering Information – Through Hole Mounting

The through hole mount version of the product is intended for through hole mounting on a PCB. When wave soldering is used, the temperature on the pins is specified to maximum 260 °C for maximum 10 seconds.

Maximum preheat rate of 4 °C/s and temperature of max 150 °C is suggested. When hand soldering, care should be taken to avoid direct contact between the hot soldering iron tip and the pins for more than a few seconds in order to prevent overheating.

A no-clean (NC) flux is recommended to avoid entrapment of cleaning fluids in cavities inside of the DC/DC power module. The residues may affect long time reliability and isolation voltage.

Delivery package information

The products are delivered antistatic trays.

Tray specifications	
Material	PET
Surface resistance	10E3 to 10E5 ohms/square
Bake ability	The trays cannot be baked
Tray capacity	12 converters/tray
Box capacity	60 converters (full trays/box)

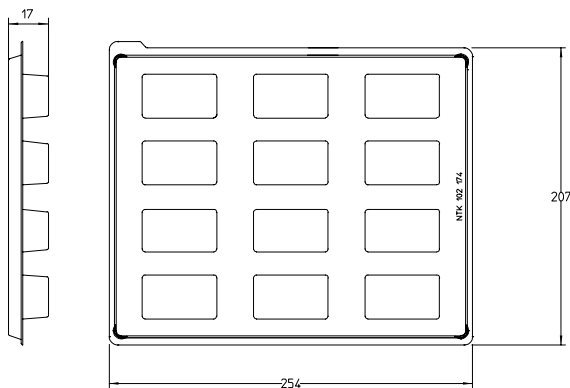

Dry pack information

The products are delivered in trays. These inner shipment containers are dry packed in standard moisture barrier bags according to IPC/JEDEC standard J-STD-033A (Handling, packing, shipping and use of moisture/reflow sensitivity surface mount devices).

Using products in high temperature Pb-free soldering processes requires dry pack storage and handling. In case the products have been stored in an uncontrolled environment and no longer can be considered dry, the modules must be baked according to the referred IPC/JEDEC standard.

PMM 8000 series PoL Regulators
 Input 8-14 V, Output 50 A / 275 W

2/ 28701- BMR 651 Rev. A November 2017

© Flex

Product Qualification Specification (pending)

Characteristics			
Visual inspection	JESD22-B101		
Temperature cycling	JESD22-A104-B	Dwell time Transfer time Temperature range Number of cycles	30 min 0-1 min -40 °C to +125 °C 300 cycles
High temperature storage life	JESD22-A103-B	Temperature Duration	125 °C 1000 h
Cold (in operation)	IEC 68-2-1A, test Ad	Temperature T _A Duration	-45 °C 72 h
Lead integrity	JESD22-B105-C	Test condition A Weight Duration	1000 g 30 s
Solder ability(only apply to through hole version)	IEC 68-2-54	Solder immersion depth Duration of immersion (F _C time) T _A (time for onset of wetting) Time to F _B Wetting strength F _B Stability F _C /F _B	1 mm 15 s <4 s 8 s >100 mN/m >0.8
Steady State Temperature Humidity Bias Life Test	JESD22-A101-B	Temperature Humidity Duration Input Voltage	+85 °C 85 % RH 1000 hours Maximum
Mechanical shock	JESD22-B104-B	Peak acceleration Duration Number of shocks	200 g 1.5 ms 5 in each of two directions of three axes
Vibration, variable freq	JESD22-B103-B	Frequency range Acceleration amplitude	10-1000 Hz 10 g or displacement amplitude 1.0 mm
Random vibration	JESD22-B103-B	Frequency Acceleration density	2-500 Hz 0.008-0.2 g ² /Hz
Operational life test		Temperature Load ON OFF Test duration	85 °C Maximum 9 min 3 min 1000 h
Moisture reflow sensitivity classification test	J-STD-020C	SnPb eutectic MSL 1	225 °C
		Pb free MSL 3	260 °C
Resistance to cleaning agents	IEC 68-2-45 Xa Method 2	Water Glycol ether Isopropyl alcohol	+55 ±5 °C +35 ±5 °C +35 ±5 °C

X-ON Electronics

Largest Supplier of Electrical and Electronic Components

Click to view similar products for [Non-Isolated DC/DC Converters](#) category:

Click to view products by [Flex Power Modules](#) manufacturer:

Other Similar products are found below :

[DP8160G-S1-R1](#) [BRFS50](#) [APTH003A0X-SRZ](#) [SPM1004-3V3C](#) [APXW012A0X3-SRDZ](#) [R-785.0-05](#) [BRFS30](#) [PJT020A0X43-SRZ](#) [CONN-KIT](#) [10E24-P15-10PPM](#) [1E24-P4-25PPM-SHV-5KV](#) [4D15-N1](#) [MYGTM01210BZN](#) [APXW012A0X3-SRDZ](#) [I6A24008A033V-N00-R](#) [10C24-N250-I10-AQ-DA](#) [4AA24-P20-M-H](#) [DX150N](#) [3V12-N0.8](#) [2HVA24-BP1-F-25PPM-SHV-5KV](#) [5HVA24-BP1-F-25PPM-SHV-5KV](#) [1/2AA24-P30-I10](#) [1C24-P20-M-C](#) [VI-920194B](#) [T31SN24005NMFA](#) [3V24-P1](#) [3V24-N1](#) [BMR4672010/001](#) [BMR4652010/001](#) [BMR4668004/001](#) [T31SN12008NMFA](#) [6AA24-P30-I5-M](#) [6AA24-N30-I5-M](#) [PTV03020WAH](#) [PTV05020WAH](#) [PTV12010LAH](#) [PTV12020WAD](#) [R-625.0D](#) [R-7212D](#) [R-7212P](#) [R-745.0D](#) [R-78AA15-0.5SMD](#) [R-78AA5.0-1.0SMD](#) [30A24-N15-E](#) [10A12-P4-M](#) [10C24-N250-I5](#) [10C24-P125](#) [10C24-P250-I5](#) [6A24-P20-I10-F-M-25PPM](#) [1A24-P30-F-M-C](#)