

FLUKE®

Fluke 123/124

Industrial ScopeMeter

Users Manual

GB
Sep 2002
© 2002 Fluke Corporation. All rights reserved.
All product names are trademarks of their respective companies.

LIMITED WARRANTY & LIMITATION OF LIABILITY

Each Fluke product is warranted to be free from defects in material and workmanship under normal use and service. The warranty period is three years for the Test Tool and one year for its accessories. The warranty period begins on the date of shipment. Parts, product repairs and services are warranted for 90 days. This warranty extends only to the original buyer or end-user customer of a Fluke authorized reseller, and does not apply to fuses, disposable batteries or to any product which, in Fluke's opinion, has been misused, altered, neglected or damaged by accident or abnormal conditions of operation or handling. Fluke warrants that software will operate substantially in accordance with its functional specifications for 90 days and that it has been properly recorded on non-defective media. Fluke does not warrant that software will be error free or operate without interruption.

Fluke authorized resellers shall extend this warranty on new and unused products to end-user customers only but have no authority to extend a greater or different warranty on behalf of Fluke. Warranty support is available if product is purchased through a Fluke authorized sales outlet or Buyer has paid the applicable international price. Fluke reserves the right to invoice Buyer for importation costs of repair/replacement parts when product purchased in one country is submitted for repair in another country.

Fluke's warranty obligation is limited, at Fluke's option, to refund of the purchase price, free of charge repair, or replacement of a defective product which is returned to a Fluke authorized service center within the warranty period.

To obtain warranty service, contact your nearest Fluke authorized service center or send the product, with a description of the difficulty, postage and insurance prepaid (FOB Destination), to the nearest Fluke authorized service center. Fluke assumes no risk for damage in transit. Following warranty repair, the product will be returned to Buyer, transportation prepaid (FOB Destination). If Fluke determines that the failure was caused by misuse, alteration, accident or abnormal condition of operation or handling, Fluke will provide an estimate of repair costs and obtain authorization before commencing the work. Following repair, the product will be returned to the Buyer transportation prepaid and the Buyer will be billed for the repair and return transportation charges (FOB Shipping Point).

THIS WARRANTY IS BUYER'S SOLE AND EXCLUSIVE REMEDY AND IS IN LIEU OF ALL OTHER WARRANTIES, EXPRESS OR IMPLIED, INCLUDING BUT NOT LIMITED TO ANY IMPLIED WARRANTY OF MERCHANTABILITY OR FITNESS FOR A PARTICULAR PURPOSE. FLUKE SHALL NOT BE LIABLE FOR ANY SPECIAL, INDIRECT, INCIDENTAL OR CONSEQUENTIAL DAMAGES OR LOSSES, INCLUDING LOSS OF DATA, WHETHER ARISING FROM BREACH OF WARRANTY OR BASED ON CONTRACT, TORT, RELIANCE OR ANY OTHER THEORY.

Since some countries or states do not allow limitation of the term of an implied warranty, or exclusion or limitation of incidental or consequential damages, the limitations and exclusions of this warranty may not apply to every buyer. If any provision of this Warranty is held invalid or unenforceable by a court of competent jurisdiction, such holding will not affect the validity or enforceability of any other provision.

Fluke Corporation, P.O. Box 9090, Everett, WA 98206-9090 USA, or
Fluke Industrial B.V., P.O. Box 90, 7600 AB, Almelo, The Netherlands

SERVICE CENTERS

To locate an authorized service center, visit us on the World Wide Web:

<http://www.fluke.com>

or call Fluke using any of the phone numbers listed below:

+1-888-993-5853 in U.S.A. and Canada

+31-402-675-200 in Europe

+1-425-446-5500 from other countries

Table of Contents

Chapter	Title	Page
	Declaration of Conformity	1
	Unpacking the Test Tool Kit	2
	Safely Using the Test Tool	4
1	Using The Test Tool	7
	Goal of this Chapter	7
	Powering the Test Tool	7
	Resetting the Test Tool	8
	Changing Backlight	9
	Reading the Screen	10
	Making Selections in a Menu	11
	Looking at the Measurement Connections.....	12
	Displaying an Unknown Signal with Connect-and View™	13
	Making Measurements	14

	Freezing the Screen.....	16
	Holding a Stable Reading	16
	Making Relative Measurements.....	17
	Selecting Auto/Manual Ranges.....	18
	Changing the Graphic Representation on the Screen	18
	TrendPlotting a Waveform	22
	Acquiring the Waveform	23
	Triggering on a Waveform	27
	Saving and Recalling a Setup and a Screen	32
	Making Cursor Measurements	35
	Using the 10:1 Probe for High Frequency Measurements	38
	Using a Printer	39
	Using FlukeView® Software	41
2	Maintaining the Test Tool.....	43
	About this Chapter	43
	Cleaning the Test Tool.....	43
	Storing the Test Tool.....	43
	Charging the Rechargeable Battery Pack.....	44
	Keeping Batteries in Optimal Condition	45
	Replacing and Disposing of the Rechargeable Battery Pack	46
	Using and Adjusting 10:1 Scope Probes	47
	Calibrating the Test Tool.....	49
	Parts and Accessories	49
3	Tips and Troubleshooting.....	53

Contents (continued)

	Goal of this Chapter	53
	Using the Tilt Stand	53
	Resetting the Test Tool	54
	Changing the Information Language	54
	Changing the Display	55
	Changing Date and Time	56
	Saving Battery Life	57
	Changing the Auto Set Options	58
	Using Proper Grounding	59
	Solving Printing and Other Communication Errors	60
	Battery Testing of Fluke Accessories	60
4	Specifications	61
	Introduction	61
	Dual Input Oscilloscope	62
	Dual Input Meter	65
	Cursor readout (Fluke 124)	68
	Miscellaneous	69
	Environmental	70
	 Safety	70

Declaration of Conformity

for
Fluke 123/124
ScopeMeter® test tool

Manufacturer

Fluke Industrial B.V.
Lelyweg 1
7602 EA Almelo
The Netherlands

Statement of Conformity

Based on test results using appropriate standards,
the product is in conformity with
Electromagnetic Compatibility Directive 89/336/EEC
Low Voltage Directive 73/23/EEC

Sample tests

Standards used:

EN 61010.1 (1993)
Safety Requirements for Electrical Equipment for
Measurement, Control, and Laboratory Use

EN 50081-1 (1992)
Electromagnetic Compatibility.
Generic Emission Standard:
EN55022 and EN60555-2

EN 50082-2 (1992)
Electromagnetic Compatibility.
Generic Immunity Standard:
IEC1000-4 -2, -3, -4, -5

The tests have been performed in a
typical configuration.

This Conformity is indicated by the symbol **CE**,
i.e. "Conformité Européenne".

Unpacking the Test Tool Kit

Note

The following items are included in your test tool kit. (see Figure 1.):

When new, the rechargeable battery pack is not fully charged. See Chapter 2.

#	Description	Fluke 123	Fluke 123/S	Fluke 124	Fluke 124/S
1	Fluke Test Tool	Model 123	Model 123	Model 124	Model 124
2	Rechargeable Battery Pack	NiCd	NiCd	NiMH	NiMH
3	Power Adapter/Battery Charger	•	•	•	•
4	Shielded Test Leads with Black Ground Leads	•	•	•	•
5	Test Lead Black (for Grounding)	•	•	•	•
6	Hook Clips (red, gray)	•	•	•	•
7	Alligator Clips (red, gray, black)	•	•	•	•
8	Banana-to-BNC Adapters (black)	• (1x)	• (2x)	• (1x)	• (2x)
9	Getting Started Manual (this book)	•	•	•	•
10	CD-ROM with Users Manuals	•	•	•	•
11	Shipment Box	•		•	
12	Optically Isolated RS-232 Adapter/Cable		•		•
13	FlukeView ScopeMeter Software for Windows		•		•
14	Hard Carrying Case		•		•
15	10:1 Voltage Probe			•	•

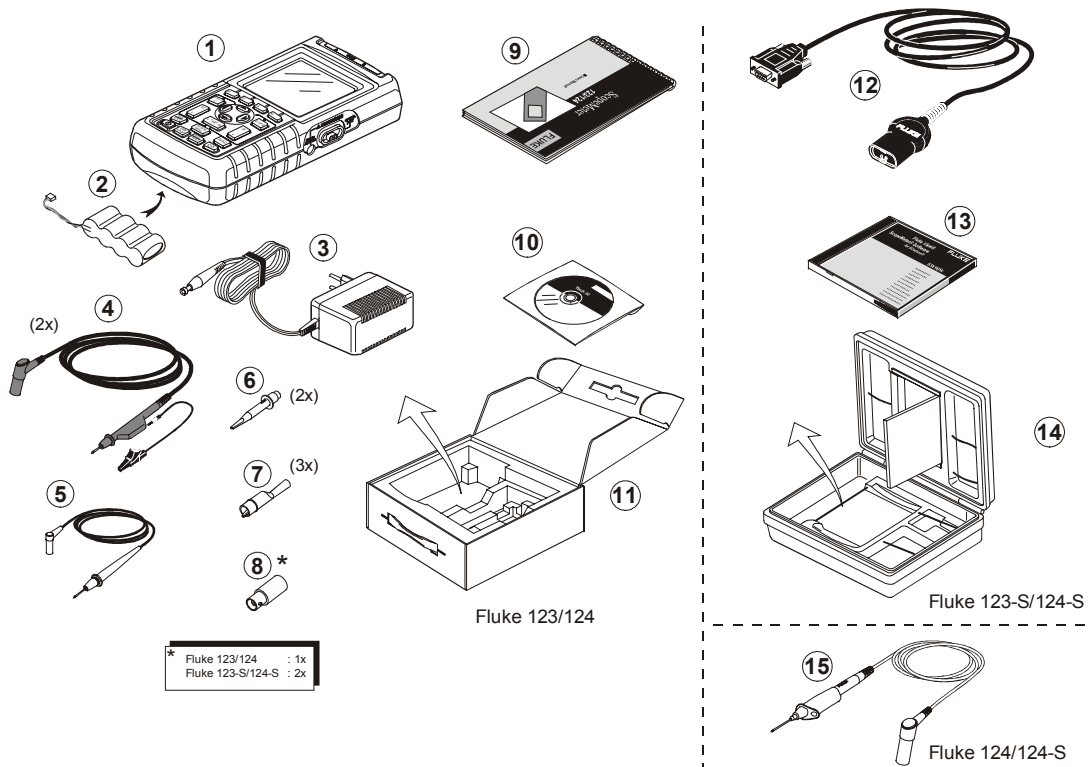

Figure 1. ScopeMeter Test Tool Kit

Safely Using the Test Tool

Attention

Carefully read the following safety information before using the test tool.

Safety Precautions

Specific warning and caution statements, where they apply, will be found throughout the manual.









A Caution identifies conditions and actions that may damage the test tool.

A Warning identifies conditions and actions that pose hazard(s) to the user.

Symbols used on the test tool and in this manual are explained in the next table.

Warning

To avoid electrical shock, use only Fluke power supply, Model PM8907 (Power Adapter/Battery Charger).

	See explanation in manual		Equal potential inputs
	Disposal information		Earth
	Recycling information		Conformité Européenne
	Double Insulation (Protection Class)		UL listed

Warning

Should this test tool be used with AC coupling selected, or manual operation of amplitude or time base ranges, the measuring results displayed on the screen may not be representative of the total signal. This can result in the presence of dangerous voltages of more than 42V peak (30V rms), not being detected. To guarantee user safety, all signals should first be measured with DC coupling selected and in fully automatic mode. This ensures that the full signal content is measured.

 **Warning** 

To avoid electrical shock or fire:

- Use only the power supply, Model PM8907 (Battery Charger / Power Adapter).
- Before use check that the selected/indicated voltage range on the PM8907 matches the local line power voltage and frequency.
- For the PM8907/808 universal Battery Charger/Power Adapter use only line cords that comply with the local safety regulations.

Note

To accommodate connection to various line power sockets, the PM8907/808 universal Battery Charger / Power Adapter is equipped with a male plug that must be connected to a line cord appropriate for local use. Since the adapter is isolated, the line cord does not need to be equipped with a terminal for connection to protective ground. Since line cords with a protective grounding terminal are more commonly available you might consider using these anyhow.

 **Warning**

To avoid electrical shock or fire if a Test Tool input is connected to more than 42 V peak (30 Vrms) or on circuits of more than 4800 VA:

- Use only insulated voltage probes, test leads and adapters supplied with the Test Tool, or indicated as suitable for the Fluke 123/124 Test Tool.
- Before use, inspect voltage probes, test leads and accessories for mechanical damage and replace when damaged.
- Remove all probes, test leads and accessories that are not in use.
- Always connect the battery charger first to the ac outlet before connecting it to the Test Tool.
- Do not connect the ground wire (Figure 1, item 5) to voltages higher than 42 V peak (30 Vrms) from earth ground.
- Do not apply input voltages above the rating of the instrument. Use caution when using 1:1 test leads because the probe tip voltage will be directly transmitted to the Test Tool.
- Do not use exposed metal BNC or banana plug connectors.

- Do not insert metal objects into connectors.
- Always use the Test Tool only in the manner specified.

 **Max. Input Voltages**

Input A and B directly	600 V CAT III
Input A and B via BB120	300 V CAT III
Input A and B via STL120	600 V CAT III

 **Max. Floating Voltage**

From any terminal to ground	600 V CAT III
-----------------------------------	---------------

Voltage ratings are given as “working voltage”. They should be read as Vac-rms (50-60 Hz) for AC sinewave applications and as Vdc for DC applications.

Overvoltage Category III refers to distribution level and fixed installation circuits inside a building.

The terms ‘Isolated’ or ‘Electrically floating’ are used in this manual to indicate a measurement in which the Test Tool’s Shielded Banana inputs or banana jack is connected to a voltage different from earth ground.

The isolated input connectors have no exposed metal and are fully insulated to protect against electrical shock.

If Safety Features are Impaired

Use of the Test Tool in a manner not specified may impair the protection provided by the equipment.

Before use, inspect the test leads for mechanical damage and replace damaged test leads!

Whenever it is likely that safety has been impaired, the Test Tool must be turned off and disconnected from the line power. The matter should then be referred to qualified personnel. Safety is likely to be impaired if, for example, the Test Tool fails to perform the intended measurements or shows visible damage.

Chapter 1

Using The Test Tool

Goal of this Chapter

This Chapter provides a step-by-step introduction to the test tool. The introduction does not cover all of the capabilities of the test tool but gives basic examples to show how to use the menus perform basic operations.

Powering the Test Tool

Follow the procedure (step 1 to 3) in Figure 1-1 to power the test tool from a standard ac outlet. See Chapter 2 for battery power instructions.



Turn the test tool on.

The test tool powers up in its last setup configuration.

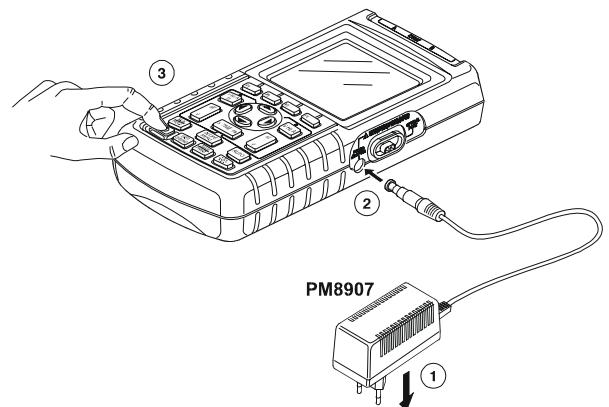





Figure 1-1. Powering the Test Tool

Resetting the Test Tool

If you want to restore the test tool settings as delivered from the factory, do the following:

- ①  Turn the test tool off.
- ②  Press and hold.
- ③  Press and release.

The test tool turns on, and you should hear a double beep, indicating the Reset was successful.

- ④  Release.

Now look at the display; you will see a screen that looks like Figure 1-2.

The F4 key of Fluke 123 is used to control the contrast; in Fluke 124 this key is used to switch the cursors on.

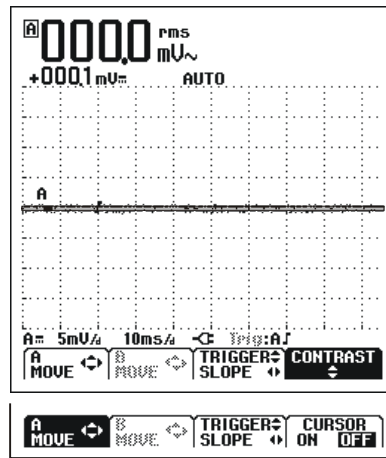

Figure 1-2. The Screen After Reset

Changing Backlight



After power-up, the screen has a high bright display.

To save battery power, the screen has an economic brightness display when operated on the battery pack (no power adapter connected).



Note

Using dimmed display lengthens maximum battery power operation time.

To change the brightness of the display in Fluke 123, do the following:

- | | | |
|---|---|-------------------------------|
| ① |  | Dim the backlight. |
| ② |  | Brighten the backlight again. |

In Fluke 124, do the following:

- | | | |
|---|--|---|
| ① |  | Press to get access to the display functions. |
| ② |  | Select LIGHT |
| ③ |  | Dim or brighten the backlight. |

The high brightness increases when you connect the power adapter.

Reading the Screen

The screen is divided into three areas: Reading area, Waveform area, and Menu area. Refer to Figure 1-3 during the following.

Reading area (A): Displays the numeric readings. Because only input A is on, you will see the input A readings only.

Waveform area (B): Displays the input A waveform. The bottom line displays the ranges/div and the power indicator (line or battery). Because only input A is on, you will see the input A waveform only.

Note

When battery powered, the battery indicator informs you about the condition of the battery from full to empty: .

Menu area (C): Displays the menu that provides choices available through the blue function keys.

When you change a setup, a part of the screen is used to display the choices. The area displays one or more menus with choices accessed with the arrow keys:

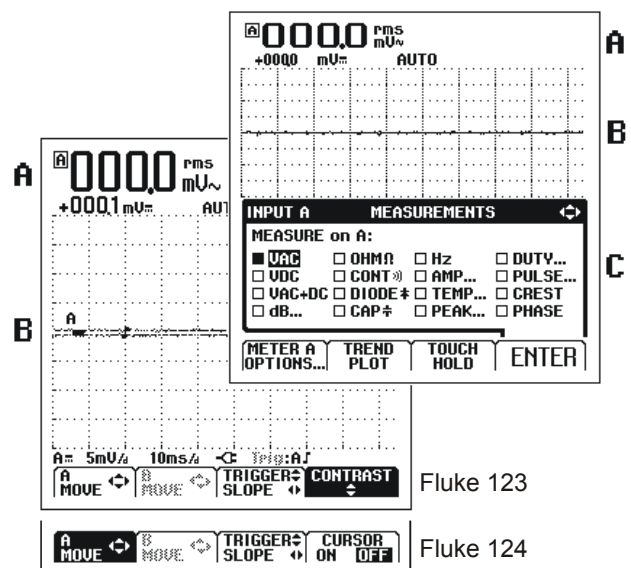
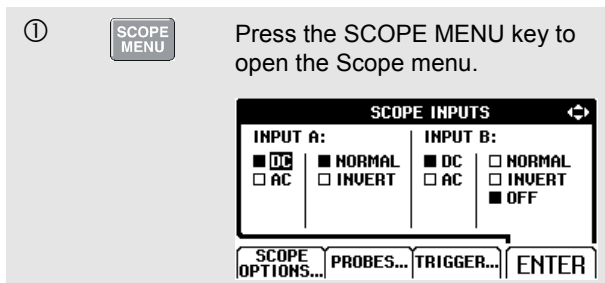

Figure 1-3. The Screen Area's

Making Selections in a Menu

Subsequently follow steps ① to ④ to open a menu and to choose an item.



Note

Pressing the SCOPE MENU key a second time closes this menu and resumes normal measurement. This toggling enables you to check the menu without destroying your settings.

- ② Use the blue arrow keys to highlight the item.
- ③ Press the blue 'ENTER' function key to confirm selection
- ④ Press 'ENTER' until you return to normal mode.

Figure 1-4 shows the basic navigation of the test tool.

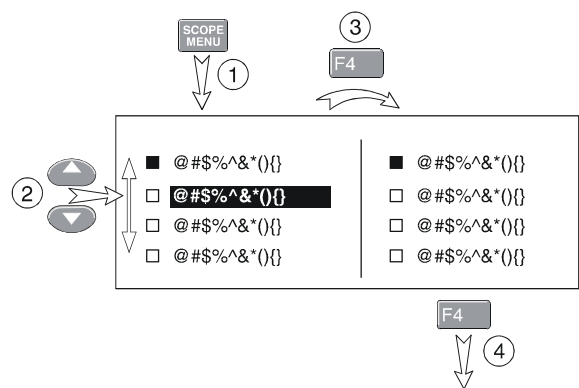

Figure 1-4. Basic Navigation

Note

When you do not change an item with the blue arrow keys, repeatedly pressing enables you to step through a menu without changing the setup of the test tool.

Looking at the Measurement Connections

Look at the top of the test tool. The test tool provides two 4-mm safety shielded banana jack inputs (red input A and gray input B) and a safety 4-mm banana jack input (COM). (See Figure 1-5.)

Input A

You can always use the red input A for all single input measurements possible with the test tool.



Input B

For measurements on two different signals you can use the gray input B together with the red input A.

COM

You can use the black COMmon as single ground for low frequency measurements, and for Continuity, Ohm (Ω), Diode, and Capacitance measurements.

Warning

To avoid electrical shock or fire, use only one COM  (common) connection, or ensure that all connections to COM  are at the same potential.

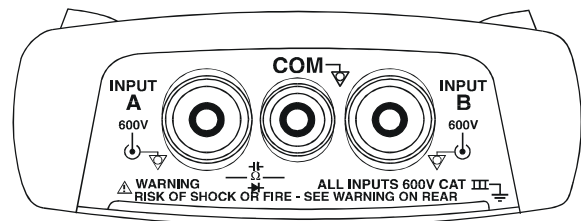

Figure 1-5. Measurement Connections

Displaying an Unknown Signal with Connect-and View™

The Connect-and-View™ function enables hands-off operation to display complex unknown signals. This function optimizes the position, range, time base, and triggering and assures a stable display on nearly all waveforms. If the signal changes, the setup will track these changes.

To enable the Connect-and-View™ function, do the following:

- Connect the red test lead from red input A to the unknown signal to be measured .

AUTO

Perform an Auto Set.

In the next example, the screen displays “1.411” in large numbers and “-0.103” in smaller numbers. A scope trace gives a graphical representation of the waveform.

The trace identifier (**A**) is visible on left of the waveform area. The zero icon (**⊖**) identifies the ground level of the waveform.

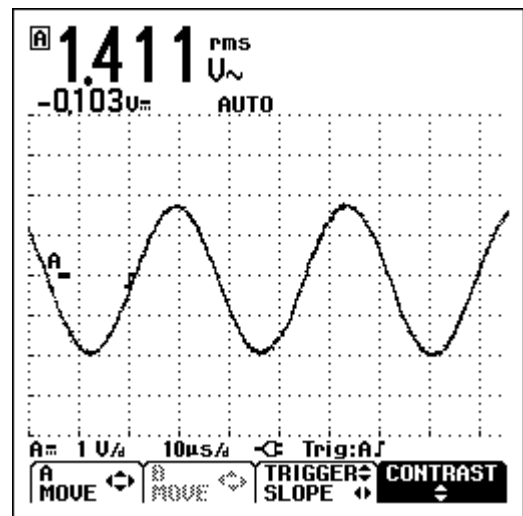

Figure 1-6. The Screen After an Auto Set

Making Measurements

The reading area displays the numeric readings of the chosen measurements on the waveform that is applied to the input jack.

- First connect the red shielded test lead from input A, and the gray shielded test lead from input B to the signals to be measured. Connect the short ground leads to the same ground potential. (See Figure 1-7.)

Note

For Ohm (Ω), continuity, diode, and capacitance measurements, use the red shielded test lead from input A and the black unshielded ground lead from COM (common). (See Figure 1-7.)

To choose a frequency measurement for Input A, do the following:

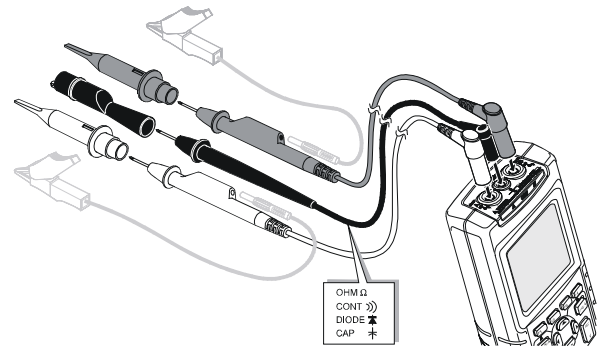
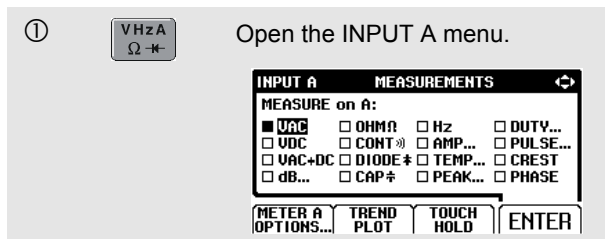
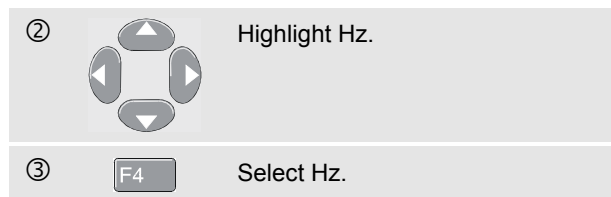



Figure 1-7. Measurement Setup





Observe that Hz is now the main reading. The former main reading has now moved to the smaller secondary reading position. (See Figure 1-8.)

To choose also a Peak-to-Peak measurement for Input B, do the following:

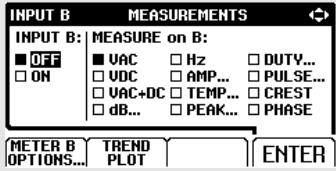
①  Open the INPUT B menu.





②  Highlight ON.

③  Turn Input B on. Observe that the highlight jumps to the present main measurement.

④  Highlight PEAK...

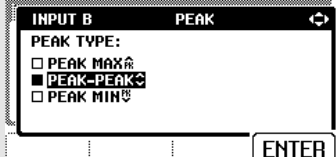
⑤  Open the PEAK submenu.



⑥  Highlight PEAK-PEAK.

⑦  Accept the pk-pk measurement.

Now, you will see a screen like Figure 1-8.

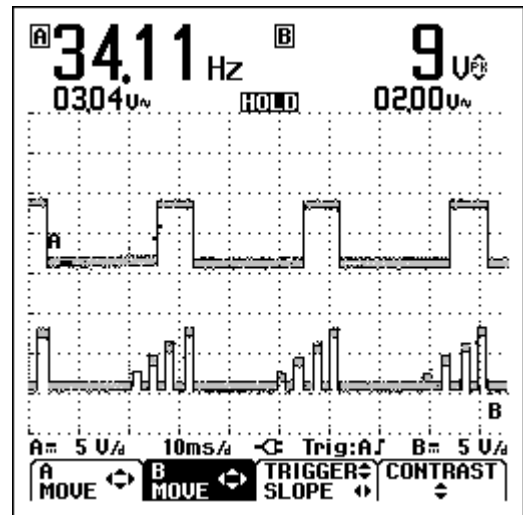



Figure 1-8. Hz and Vpp as Main Readings

Freezing the Screen



You can freeze the screen (all readings and waveforms) at any time.

- | | | |
|---|---|---|
| ① |  | Freeze the screen. HOLD appears at the bottom of the reading area. |
| ② |  | Resume your measurement. |

Holding a Stable Reading

The Touch Hold[®] function captures and freezes the next stable measurement result. A beep indicates that a stable measurement has been made.

Use the following procedure for the Touch Hold function:

- | | | |
|---|--|---|
| ① |  | Open the INPUT A menu. |
| ② |  | TOUCH HOLD OFF appears on bottom of the screen. |
| ③ | | Measure the signal. |
| ④ |  | Wait until an audible beep: now you have a stable display.

The screen continues to update with valid readings (and beeps) as long as you maintain the measurement connections. |

Because no special keys accompany the Touch Hold function, you can use this function for hands-free measurements.

- | | | |
|---|---|-------------------------------|
| ⑤ |  | Return to normal measurement. |
|---|---|-------------------------------|

Making Relative Measurements

Zero Reference displays the present measurement result with respect to the defined value. This feature is useful when you need to monitor the measured value in relation to a known good value.

①		Open the INPUT A menu.															
②		Open the METER A OPTIONS submenu.															
<table border="1"> <thead> <tr> <th>INPUT A</th> <th colspan="2">METER OPTIONS</th> </tr> </thead> <tbody> <tr> <td>COUPLING:</td> <td>SMOOTHING:</td> <td>ZERO REF:</td> </tr> <tr> <td><input checked="" type="checkbox"/> AC+DC</td> <td><input type="checkbox"/> FAST</td> <td><input checked="" type="checkbox"/> OFF</td> </tr> <tr> <td><input type="checkbox"/> AC ONLY</td> <td><input checked="" type="checkbox"/> NORMAL</td> <td><input type="checkbox"/> ON</td> </tr> <tr> <td></td> <td><input type="checkbox"/> SMOOTH</td> <td></td> </tr> </tbody> </table>			INPUT A	METER OPTIONS		COUPLING:	SMOOTHING:	ZERO REF:	<input checked="" type="checkbox"/> AC+DC	<input type="checkbox"/> FAST	<input checked="" type="checkbox"/> OFF	<input type="checkbox"/> AC ONLY	<input checked="" type="checkbox"/> NORMAL	<input type="checkbox"/> ON		<input type="checkbox"/> SMOOTH	
INPUT A	METER OPTIONS																
COUPLING:	SMOOTHING:	ZERO REF:															
<input checked="" type="checkbox"/> AC+DC	<input type="checkbox"/> FAST	<input checked="" type="checkbox"/> OFF															
<input type="checkbox"/> AC ONLY	<input checked="" type="checkbox"/> NORMAL	<input type="checkbox"/> ON															
	<input type="checkbox"/> SMOOTH																
③		Jump to ZERO REF.															
④		Highlight ON.															
⑤		Activate the relative measurement.															

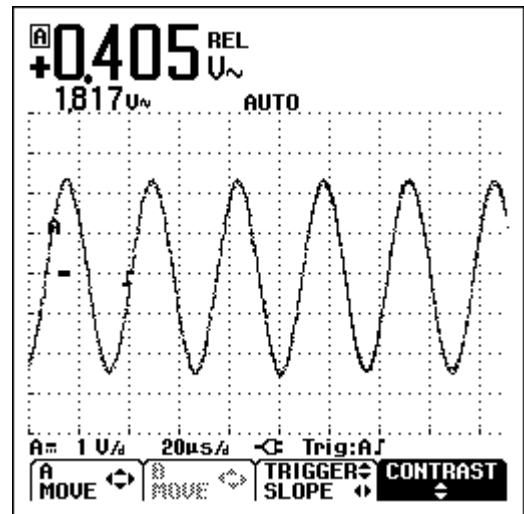



Figure 1-9. Making a Relative Measurement

The relative measurement now becomes the main reading, while the former main measurement has moved to the smaller secondary reading position. (See Figure 1-9.)

Selecting Auto/Manual Ranges



Press  to automatically adjust the position, range, time base, and triggering. This assures a stable display on nearly all waveforms. The bottom line shows the range, the time base for both inputs, and the trigger information.

Press  a second time to select the manual range. **MANUAL** appears at the bottom of the reading area.

Changing the Graphic Representation on the Screen

From Auto range, you can use the light-gray rocker keys to change the graphic representation on the screen manually.



Changing the Amplitude

- | | | |
|---|---|-----------------------|
| ① |  | Enlarge the waveform. |
| ② |  | Reduce the waveform. |

Available settings are from 5 mV/div to 500 V/div when using the test leads.

Observe that **AUTO** at the bottom of the reading area disappears to indicate that the continuous Auto Set function is not valid anymore.

Changing the Time Base

- | | | |
|---|---|---------------------------------|
| ① |  | Increase the number of periods. |
| ② |  | Decrease the number of periods. |

Available settings are from 20 ns/div (Fluke 123) or 10 ns/div (Fluke 124) to 5 s/div in normal mode.

Positioning the Waveform on the Screen

Considerable flexibility is offered in moving the waveform(s) around the screen.

- ① F4 Press until you have left any open menu. Observe that the following main menu appears on bottom of the screen.

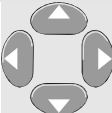
A MOVE ⇌
B MOVE ⇌
TRIGGER SLOPE ⇌
CONTRAST ⇌
- ② F1 Choose A MOVE.
- ③  Position the waveform of INPUT A on the screen.

Waveform positioning is demonstrated in Figure 1-10.

Observe that the trigger identifier (J) moves horizontally on the screen.

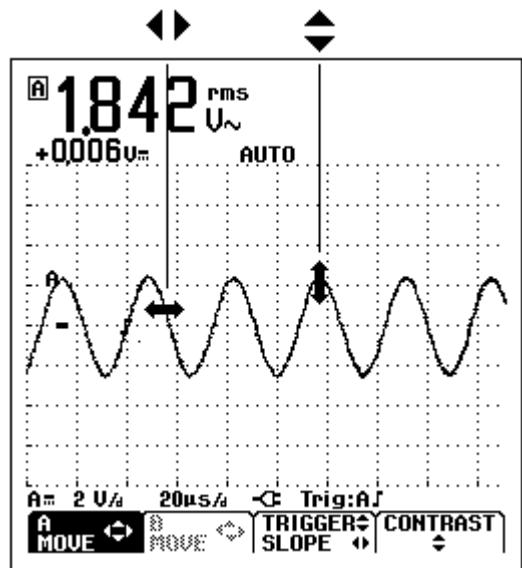

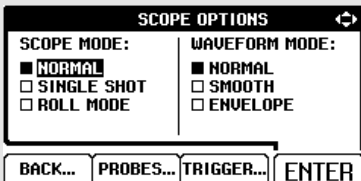

Figure 1-10. Positioning the Waveform



Smoothing the Waveform

To smooth the waveform, do the following:

- ①  Open the SCOPE INPUTS menu.
- ②  Open the SCOPE OPTIONS submenu.

The SCOPE OPTIONS menu is shown with the following settings:

SCOPE MODE:	WAVEFORM MODE:
<input checked="" type="checkbox"/> NORMAL	<input checked="" type="checkbox"/> NORMAL
<input type="checkbox"/> SINGLE SHOT	<input type="checkbox"/> SMOOTH
<input type="checkbox"/> ROLL MODE	<input type="checkbox"/> ENVELOPE

Buttons: BACK... PROBES... TRIGGER... ENTER
- ③  Jump to WAVEFORM MODE.
- ④  Highlight SMOOTH.
- ⑤  Accept waveform smooth.

You can use waveform smooth to suppress noise without loss of bandwidth. Waveform samples with and without smoothing are shown in Figure 1-11.

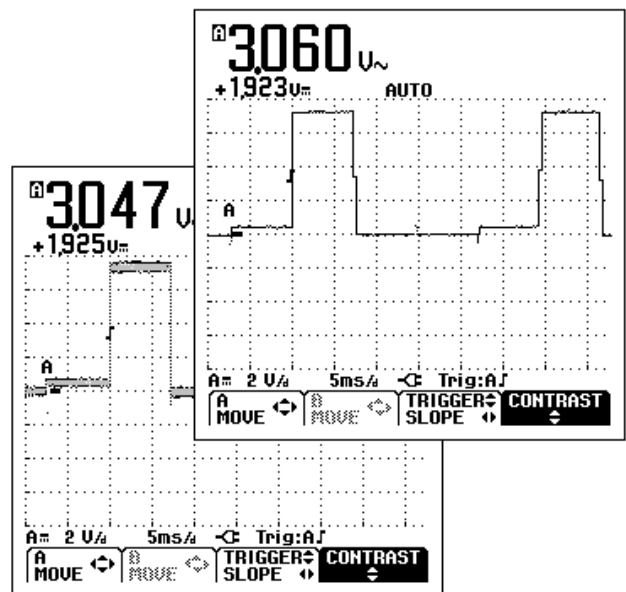



Figure 1-11. Smoothing the Waveform

Displaying the Envelope of a Waveform

The test tool records the envelope (minimum and maximum) of the live waveforms A and B.

Repeat the first three actions of 'Smoothing the Waveform', and then do the following:

- ④  Highlight ENVELOPE.
- ⑤  Start monitoring the envelope of the waveform.

The screen shows the resultant envelope in a gray waveform. See Figure 1-12.

You can use ENVELOPE to observe variations in time or amplitude of input waveforms over a longer period of time.

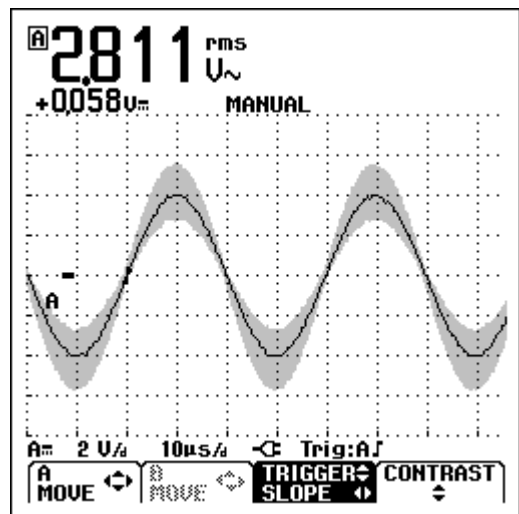



Figure 1-12. Displaying the Envelope of a Waveform

TrendPlotting a Waveform

The TrendPlot™ function plots the digital readings as a function of time. Date and time stamp shows the time of the most recent change in a MIN or MAX reading.

Starting a TrendPlot™ function

- ①  Open the INPUT A menu.
- ②  Start TRENDPLOT.

The test tool records the minimum (MIN) reading as the main (upper displayed) measurement of input A. The date and time stamp appear below the MIN reading. (See Figure 1-13.)

The test tool also continuously logs all readings to memory and displays these as graphs. Automatic vertical scaling and horizontal time compression resizes the TrendPlot to fit on the screen. The TrendPlot is built up on the screen from left to right until the screen is full. The automatic time scaling then compresses this information to about half the screen.

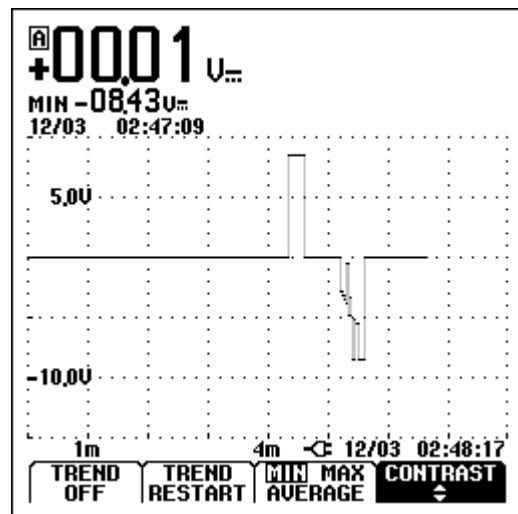



Figure 1-13. TrendPlot Reading

Note

When a new minimum value is detected, a beep occurs and the new minimum is displayed.

Changing the TrendPlot Reading

To toggle the TrendPlot reading between MIN (minimum), MAX (maximum), and AVERAGE, do the following:

- ③  Change MIN into MAX reading.
- ④  Change MAX into AVG reading.

Note that the date and time stamp now updates continuously to indicate the most recent change in a reading.

Turning Off the TrendPlot Display



- ⑤  Turn TrendPlot off again.

Acquiring the Waveform

Making a Single Acquisition



To catch single events, you can perform a single shot. (One time screen update.) To set up the test tool for a single shot on the input A waveform, do the following:

- Connect the probe to the signal to be measured.

- ①  Open the SCOPE INPUTS menu.
- ②  Open the SCOPE OPTIONS submenu.

SCOPE OPTIONS ↔

<p>SCOPE MODE:</p> <p><input checked="" type="checkbox"/> NORMAL</p> <p><input type="checkbox"/> SINGLE SHOT</p> <p><input type="checkbox"/> ROLL MODE</p>	<p>WAVEFORM MODE:</p> <p><input checked="" type="checkbox"/> NORMAL</p> <p><input type="checkbox"/> SMOOTH</p> <p><input type="checkbox"/> ENVELOPE</p>
--	---

BACK...
PROBES...
TRIGGER...
ENTER
- ③  Highlight SINGLE SHOT.
- ④  (2x) Accept the set up for a Single Shot.

- ⑤  **Wait** appears on bottom of the screen to indicate that the test tool is waiting for a trigger.
- ⑥ **Run** appears on bottom of the screen when the single acquisition is triggered.
- ⑦ **Hold** appears on bottom of the screen when the single acquisition has been completed.

The test tool will now have a screen like Figure 1-14.

To perform a next single acquisition, do the following:

-  Wait for another single acquisition trigger.

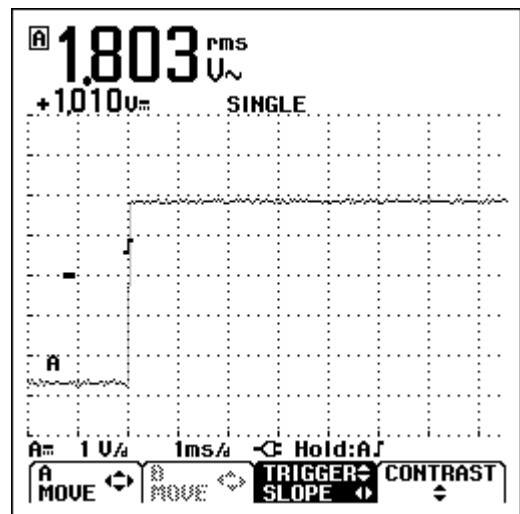



Figure 1-14. Making a Single Acquisition



Recording Slow Signals over a Long Period of Time

The roll mode function supplies a visual log of waveform activity and is especially useful when you measure lower frequency waveforms.

- ①  Open the SCOPE INPUTS menu.
- ②  Open the SCOPE OPTIONS submenu.

SCOPE OPTIONS ↔

<p>SCOPE MODE:</p> <p><input checked="" type="checkbox"/> NORMAL</p> <p><input type="checkbox"/> SINGLE SHOT</p> <p><input type="checkbox"/> ROLL MODE</p>	<p>WAVEFORM MODE:</p> <p><input checked="" type="checkbox"/> NORMAL</p> <p><input type="checkbox"/> SMOOTH</p> <p><input type="checkbox"/> ENVELOPE</p>
--	---

BACK... PROBES... TRIGGER... ENTER
- ③  Highlight ROLL MODE.
- ④  Start Recording.

The waveform moves across the screen from right to left like a normal chart recorder. Observe that during recording no measurements are made. (See Figure 1-15.)

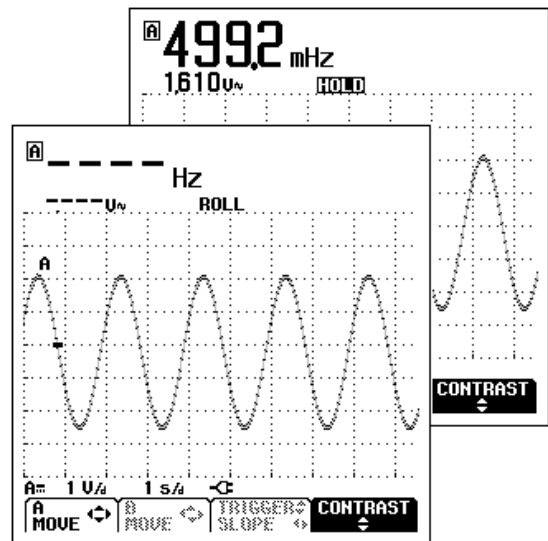





Figure 1-15. Recording Waveforms over Longer Period of Time

- ⑤  Freeze Recording.

Observe that the measurement values are only displayed after  is pressed. (See figure 1-15.)

Selecting AC-Coupling

Use AC-coupling when you wish to observe a small AC signal that rides on a DC signal.

①  Open the SCOPE INPUTS menu.

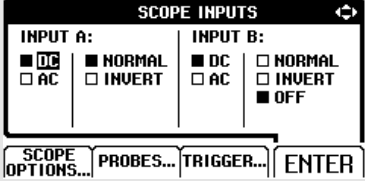

②  Highlight AC.

③  (4x) Accept AC-coupling for INPUT A.

Reversing the Polarity of the Displayed Waveform

To invert the input A waveform, do the following:

①  Open the SCOPE INPUTS menu.

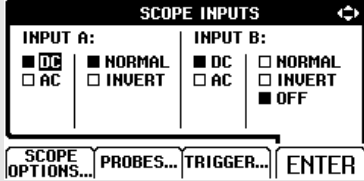

②  Select NORMAL (of INPUT A).

③  Highlight INVERT.

④  (3x) Accept inverted waveform display.

For example, a negative-going waveform is displayed as positive-going, providing a more meaningful viewing perspective in some cases. An inverted display is identified by trace identifier **A** on left of the waveform area.

Triggering on a Waveform







Triggering tells the test tool when to begin displaying the waveform. You can select which input signal should be used, on which edge this should occur, and you can define the condition for a new update of the waveform. Finally you can tell the test tool to trigger on video signals.



The bottom line of the waveform area identifies the trigger parameters being used. Trigger icons on the screen indicate the trigger level and slope. (See Figure 1-16.)

Setting Trigger Level and Slope

- ①  Perform an AUTO SET.

For quick operation, use the AUTO SET key to automatically trigger on nearly all signals. To optimize trigger level and slope manually, do the following:

- ①  Press until you have left any open menu.
 -    
- ②  Enable the arrow keys for Trigger Level and Slope adjustment.

- ③  Adjust the Trigger Level continuously. Observe the trigger icon on the second time division line indicates the trigger level.
- ④  Trigger on either positive Slope or negative Slope of the chosen waveform.

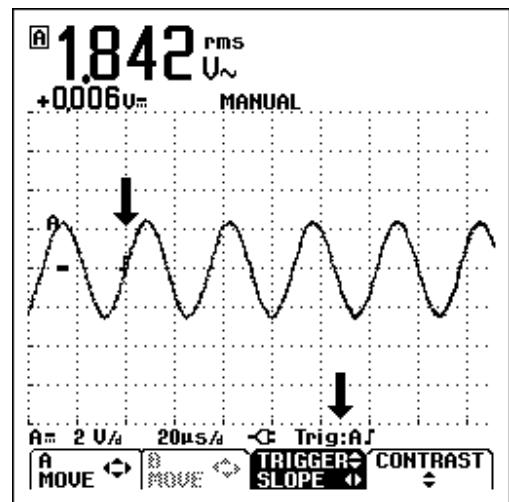











Figure 1-16. Screen with all Trigger Information

Selecting the Trigger Parameters

To trigger on the input A waveform, with automatic screen update, and to configure the auto range triggering for waveforms from 1 Hz, do the following:

①		Open the SCOPE INPUTS menu.
②		Open the TRIGGER submenu.
		
③		Highlight Input 'A'.
④		Select Input 'A'.
⑤		Highlight FREE RUN.
⑥		Select FREE RUN.
⑦		Highlight >1 Hz

⑧  Accept all trigger selections and return to normal measurement.

Note

Setting the automatic triggering to >1Hz will slow down the auto range.

TRIG:A appears in gray text on bottom of the screen when no trigger is found.

Note

Gray text in a menu or button bar indicates that the function is disabled or the status is not valid.

Isolated Triggering

Use the optically isolated trigger probe (ITP120, optional) to trigger on an external source, and to isolate the test tool from a trigger waveform. See Figure 1-17.

To choose the isolated trigger probe, select 'EXT' in point ④ of the previous example. Trigger level is fixed and is TTL compatible.

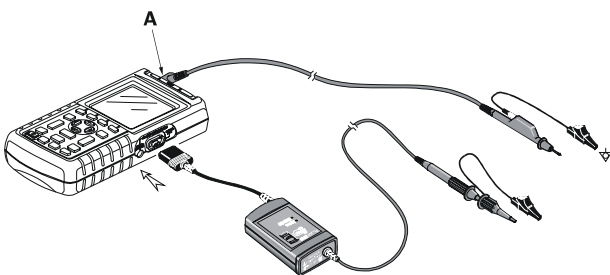



Figure 1-17. Isolated Triggering

Triggering on Video Signals

- Apply an interlaced video signal to the red input A.

To trigger on a random video line, continue from point ② of the previous example as follows:

③		Highlight VIDEO on A.
④		Open the VIDEO TRIGGER submenu.
⑤		Highlight PAL.
⑥		Select PAL.
⑦		Highlight RANDOM.
⑧		Select RANDOM.

- ⑨  Highlight POSITIVE.
- ⑩  Accept the video trigger selections .

Trigger level and slope are now fixed. (See Figure 1-18.) Positive video is indicated as a “+” icon on bottom of the screen.

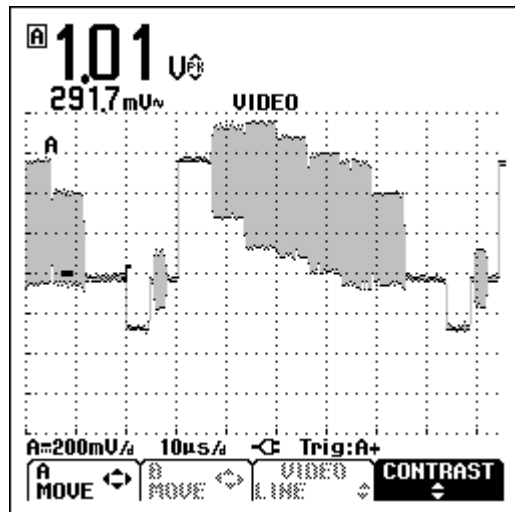



Figure 1-18. Measuring Video Signals

Triggering on a Specific Video Line



To view a specific video line in more detail you can select the line number. To measure on a selected video line, continue from point ⑥ of the previous example as follows:

⑦   Highlight SELECT

VIDEO TRIGGER ↔

SYSTEM:	LINE:	POLARITY
<input checked="" type="checkbox"/> PAL	<input type="checkbox"/> RANDOM	<input checked="" type="checkbox"/> POSITIVE
<input type="checkbox"/> NTSC	<input checked="" type="checkbox"/> SELECT	<input type="checkbox"/> NEGATIVE
<input type="checkbox"/> PALplus		
<input type="checkbox"/> SECAM		



⑧  Select SELECT

⑨   Highlight POSITIVE.

⑩  Accept the video trigger selections .

Pressing  selects the line number function.

To choose line 135, do the following:

- ①  Enable video line selection.
- ②   Select number 135.

Saving and Recalling a Setup and a Screen

You can save Screens and Setups to memory, and recall them again for later use. Fluke 123 has 10 memories while Fluke 124 has 20 memories. In each memory you can save a screen and the related settings.

Saving Screens with Belonging Setups

To save a screen and setups in e.g. memory location 7, do the following:

①  Open the SAVE/PRINT menu.

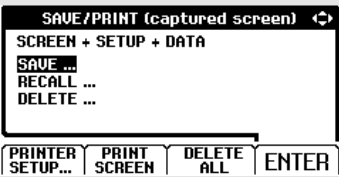

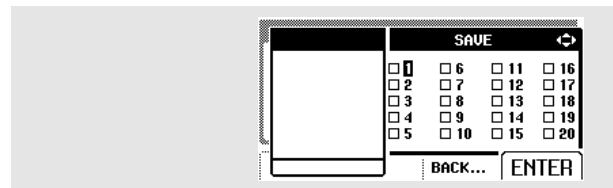

Observe that SAVE ... is already highlighted and that the screen is frozen until you leave the SAVE/PRINT menu again.

②  Open the SAVE ... submenu.



Note that free memory locations are indicated by an open square () in front of the memory number.

③  Highlight memory location 7.

④  Save the actual screen and settings.

The actual screen and settings are saved in memory location 7 and the instrument returns to normal signal acquisition again.

Recalling Screens and Setups

To recall a screen and setups, do the following:

①  Open the SAVE/PRINT menu.

②  Highlight RECALL ...

SAVE/PRINT (captured screen) <=>

SCREEN + SETUP + DATA

SAVE ...

RECALL ...

DELETE ...

PRINTER SETUP... PRINT SCREEN DELETE ALL ENTER

③  Open the RECALL ... submenu.

RECALL <=>			
<input type="checkbox"/> 1	<input type="checkbox"/> 6	<input type="checkbox"/> 11	<input type="checkbox"/> 16
<input type="checkbox"/> 2	<input checked="" type="checkbox"/> 7	<input type="checkbox"/> 12	<input type="checkbox"/> 17
<input type="checkbox"/> 3	<input type="checkbox"/> 8	<input type="checkbox"/> 13	<input type="checkbox"/> 18
<input type="checkbox"/> 4	<input type="checkbox"/> 9	<input type="checkbox"/> 14	<input type="checkbox"/> 19
<input type="checkbox"/> 5	<input type="checkbox"/> 10	<input type="checkbox"/> 15	<input type="checkbox"/> 20

BACK... ENTER

Already filled memory locations are indicated with a closed square (■).

④  Highlight memory 7.

SETUP 7	RECALL <=>
A-m-U/v 100mU/s	<input type="checkbox"/> 1 <input type="checkbox"/> 6 <input type="checkbox"/> 11 <input type="checkbox"/> 16
	<input type="checkbox"/> 2 <input checked="" type="checkbox"/> 7 <input type="checkbox"/> 12 <input type="checkbox"/> 17
	<input type="checkbox"/> 3 <input type="checkbox"/> 8 <input type="checkbox"/> 13 <input type="checkbox"/> 18
T: 10ms/s	<input type="checkbox"/> 4 <input type="checkbox"/> 9 <input type="checkbox"/> 14 <input type="checkbox"/> 19
AUTO	<input type="checkbox"/> 5 <input type="checkbox"/> 10 <input type="checkbox"/> 15 <input type="checkbox"/> 20

06/07/02 10:01 BACK... ENTER

⑤  View the saved screen and belonging settings.

Observe that the recalled waveform is displayed and that HOLD appears on the screen. From this point you can use cursors for analysis or you can print the recalled screen. The instrument returns to signal acquisition if you press the HOLD/RUN key. The settings such as stored in memory location 7 are used then.

Deleting Screens and Associated Setups

To delete all or just 1 screen + setups, do the following:

①  Open the SAVE/PRINT menu.

If you want to clear all memory locations, press F3 DELETE ALL. If you want to clear just 1 memory location (e.g. memory 7), do the following:

②  Highlight DELETE ...

③  Open the DELETE ... submenu.

DELETE			
<input type="checkbox"/> 1	<input type="checkbox"/> 6	<input type="checkbox"/> 11	<input type="checkbox"/> 16
<input type="checkbox"/> 2	<input checked="" type="checkbox"/> 7	<input type="checkbox"/> 12	<input type="checkbox"/> 17
<input type="checkbox"/> 3	<input type="checkbox"/> 8	<input type="checkbox"/> 13	<input type="checkbox"/> 18
<input type="checkbox"/> 4	<input type="checkbox"/> 9	<input type="checkbox"/> 14	<input type="checkbox"/> 19
<input type="checkbox"/> 5	<input type="checkbox"/> 10	<input type="checkbox"/> 15	<input type="checkbox"/> 20

BACK... ENTER

Filled memory locations are indicated with a closed square.

④  Highlight memory 7.

SETUP 7	DELETE			
AmmU _v	<input type="checkbox"/> 1	<input type="checkbox"/> 6	<input type="checkbox"/> 11	<input type="checkbox"/> 16
100mU _i	<input type="checkbox"/> 2	<input checked="" type="checkbox"/> 7	<input type="checkbox"/> 12	<input type="checkbox"/> 17
	<input type="checkbox"/> 3	<input type="checkbox"/> 8	<input type="checkbox"/> 13	<input type="checkbox"/> 18
T: 10ms _i	<input type="checkbox"/> 4	<input type="checkbox"/> 9	<input type="checkbox"/> 14	<input type="checkbox"/> 19
AUTO	<input type="checkbox"/> 5	<input type="checkbox"/> 10	<input type="checkbox"/> 15	<input type="checkbox"/> 20

06/07/02 10:01 BACK... ENTER

Observe that the settings and date/time of creation of the waveform in memory 7 are displayed now.









⑤  The contents of memory 7 are deleted and the instrument returns to normal signal acquisition.

Making Cursor Measurements

Fluke 124 has cursors. Cursors allow you to make precise digital measurements on waveforms. This can be done on live waveforms and on saved waveforms.

Using Horizontal Cursors on a Waveform

To use the cursors for a voltage measurement, do the following:

- | | | |
|---|---|--|
| ① |  | From Scope mode, display the Cursor Key functions. |
| | |  |
| ② |  | Press to highlight  . Observe that two horizontal cursor lines are displayed. |
| ③ |  | Highlight the upper cursor. |
| ④ |  | Move the upper cursor to the desired position on the screen. |
| ⑤ |  | Highlight the lower cursor. |
| ⑥ |  | Move the lower cursor to the desired position on the screen. |

Note

Even when the key labels are not displayed at the bottom of the screen, you can still use the arrow keys.

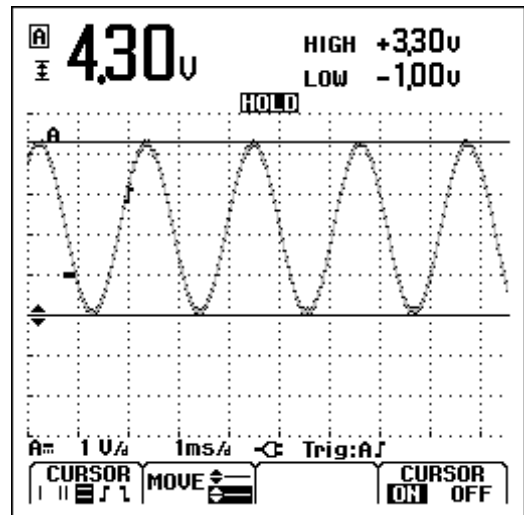





Figure 1-19. Voltage Measurement with Cursors

The readout shows the time difference 't' between the cursors and the voltage difference between the two markers (See Figure 1-20). The signal frequency is displayed behind 1/t if exactly 1 signal period is between the cursors.

Making Rise Time Measurements

To measure rise time, do the following:

- ① **F4** From Scope mode, display the Cursor Key functions.

- ② **F1** Press to highlight **r** (rise time). Observe that two horizontal cursors are displayed.
- ③ **F3** If only one trace is displayed, select MANUAL or AUTO. AUTO automatically does steps 4 to 6. For multiple traces select the required trace A or B.
- ④  Move the upper cursor to 100% of the trace height. A marker is shown at 90%.

- ⑤ **F2** Highlight the other cursor.
- ⑥  Move the lower cursor to 0% of the trace height. A marker is shown at 10%.

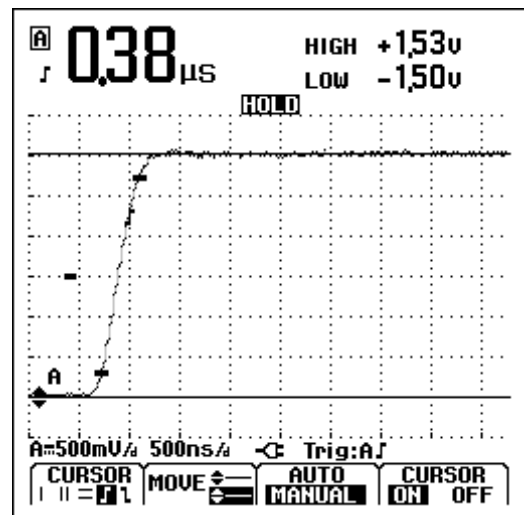



Figure 1-21. Risetime Measurement with Cursors

The reading now shows the risetime from 10%-90% of the trace amplitude and the voltage at the cursors in relation to the zero icon (-). See Figure 1-21.

⑦  Turn off the cursors.





Using the 10:1 Probe for High Frequency Measurements.

Fluke 124 is supplied with a model VP40 10:1 Probe. Use of this Probe is recommended when you measure high frequency signals in circuits with a high impedance. The loading of the circuit by a 10:1 Probe is much lower than that of a 1:1 Shielded Test Lead.

The following aspects must be observed when using a 10:1 Probe:

Probe Attenuation.

The Probe attenuates the signal 10 times. Proceed as follows to adapt the Test Tool's voltage readout to this attenuation. The example below is for a Probe connected to input B:

①		Open the Scope menu.
②		Open the Probes menu.
③		Select PROBE on B ...
④		Press ENTER
⑤		Select 10:1 V

⑥  Press ENTER to confirm the selection.

Observe that the 10 times attenuation of the Probe is compensated in the voltage readout.

Probe Adjustment.

The Probe of model VP40 such as supplied with the Test Tool is always adapted correctly to its inputs: high frequency adjustment is not necessary. Other 10:1 Probes however must be adjusted for optimal High Frequency performance. How to adjust these Probes is explained in Chapter 2 under 'Using and Adjusting 10:1 Scope Probes'.

Using a Printer

To print a (graphic) hard copy of the present screen, you need to use one of the following:

- The Optically Isolated RS-232 Adapter/Cable (PM9080) to connect a serial printer to the OPTICAL PORT of the test tool. See Figure 1-22.
- The Print Adapter Cable (PAC91, optional) to connect a parallel printer to the OPTICAL PORT of the test tool. See Figure 1-23.

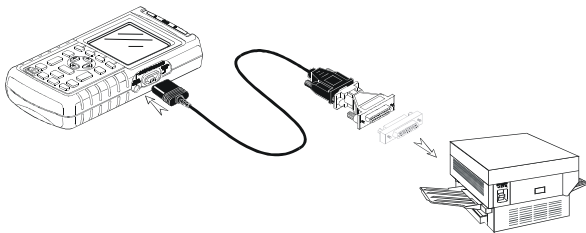

Figure 1-22. Connecting a Serial Printer

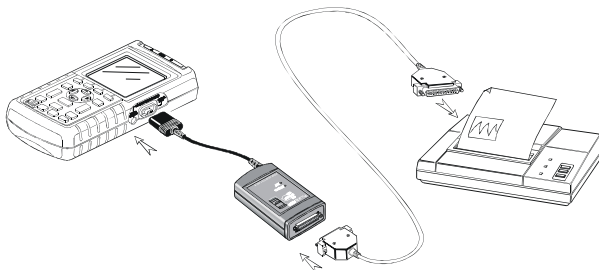



Figure 1-23. Connecting a Parallel Printer

This example covers how to set up the test tool to print on a HP Deskjet printer with a baudrate of 9600 baud:

①		Open the SAVE&PRINT menu. Observe that the screen is frozen.
②		Open the PRINTER SETUP submenu.
③		Highlight DESKJET.
④		Select DESKJET.
⑤		Highlight 9600.
⑥		Accept the print selections.

Now you are ready to print.

To print a **live** screen, do the following:

- | | | |
|---|---|---------------------------|
| ⑦ |  | Open the SAVE&PRINT menu. |
| ⑧ |  | Start printing. |

To print a **recalled** screen, do the following:

- | | | |
|---|---|-----------------|
| ⑨ |  | Start printing. |
|---|---|-----------------|

A message that indicates that the test tool is printing appears on bottom of the screen.

Using FlukeView® Software

To connect the test tool to a computer for using the FlukeView software for Windows® (SW90W), do the following:

- Use the Optically Isolated RS-232 Adapter/Cable (PM9080) to connect a computer to the OPTICAL PORT of the test tool. See Figure 1-24.

For all information relating to installing and using the FlukeView ScopeMeter software, see the SW90W Users Manual.

A Software & Cable Carrying Case Kit is optional available as model number SCC 120.

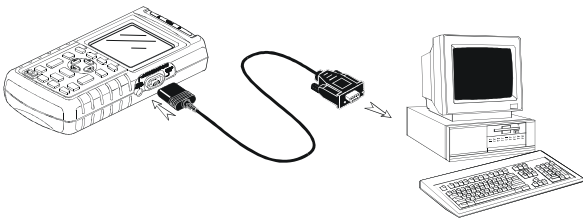

Figure 1-24. Connecting a Computer

Chapter 2

Maintaining the Test Tool

About this Chapter

This chapter covers basic maintenance procedures that can be performed by the user. For complete service, disassembly, repair, and calibration information, see the Service Manual. You will find the part number of the Service Manual in the section 'Parts and Accessories' in this manual.

Cleaning the Test Tool







Clean the test tool with a damp cloth and a mild soap to avoid abrasion of text on the test tool. Do not use abrasives, solvents, or alcohol.

Storing the Test Tool

If you are storing the test tool for an extended period of time, charge the rechargeable battery pack before storing. It is not necessary to remove the battery pack.

Charging the Rechargeable Battery Pack

At delivery, the batteries may be empty and must be charged (test tool is off) to fill them completely. Charging time is 5 hours for Fluke 123 (Ni-Cd battery) and 7 hours for Fluke 124 (Ni-MH battery). When fully charged, the batteries typically provide 4 hours of use in Fluke 123 and 6 hours in Fluke 124 at full brightness. Operating time is extended at normal brightness.

When battery powered, the battery indicator on the bottom of the screen informs you about the condition of the battery. The battery symbols are:     . The battery symbol  indicates that there are typically five minutes of operating time left.

Use the setup as shown in Figure 2-1 to charge the battery pack and power the instrument.

Turn the test tool off to charge the batteries more quickly.

Note

The test tool uses a trickle charge for the batteries, so no damage can occur if you leave it charging for long periods, e.g., through the weekend.

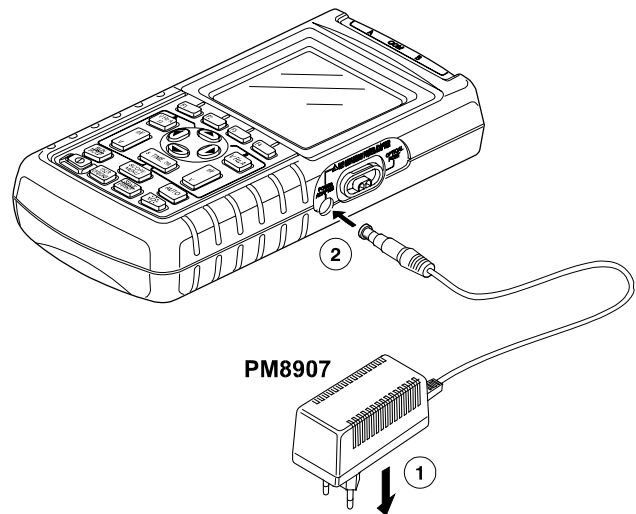



Figure 2-1. Charging the Battery Pack

Keeping Batteries in Optimal Condition

Always operate the test tool on batteries until an -icon appears on the bottom line of the screen. This indicates that the battery level is low and that the batteries need to be recharged.

Frequent charging of the batteries when they are not completely empty can reduce the operating time for the test tool.





You can refresh the battery pack at any time. This battery refresh cycle fully discharges and charges the battery pack. A complete refresh cycle takes about 14 hours (Fluke 123 with Ni-Cd battery) or 19 hours (Fluke 124 with Ni-MH battery) and should be done at least four times a year.

Note

Be sure not to disconnect the Power Adapter during the complete refresh cycle. Doing so will interrupt the refresh cycle.

To refresh the battery pack, do the following:

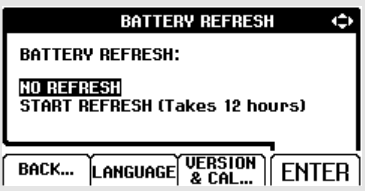
- Be sure that the test tool is line powered.

①		Open the USER OPTIONS menu.
②		Open the BATTERY REFRESH submenu.
		
③		Highlight START REFRESH.
④		Start the refresh cycle.

Note

After start of the refresh cycle, the screen will be black. The backlight is on during discharging within the refresh cycle.

Replacing and Disposing of the Rechargeable Battery Pack

Warning

To avoid electrical shock, remove the test leads and probes before replacing the battery pack.



Note

This instrument contains Ni-Cd or Ni-MH batteries. Do not dispose of this battery pack with other solid waste. Used batteries should be disposed of by a qualified recycler or hazardous materials handler. Contact your authorized FLUKE Service Center for recycling information.

To replace the battery pack, do the following: (See Figure 2-2.)

1. Disconnect the test leads and probes both at the source and at the test tool.
2. Power the test tool with the Power Adapter. This ensures information stored in memories will not be lost.
3. Locate the battery access cover on the bottom rear. Loosen the screw with a flat-blade screwdriver.
4. Lift the battery access cover away from the test tool.
5. Take the battery pack out of the battery compartment.
6. Remove the battery plug from the connector.
7. Install a new battery pack.

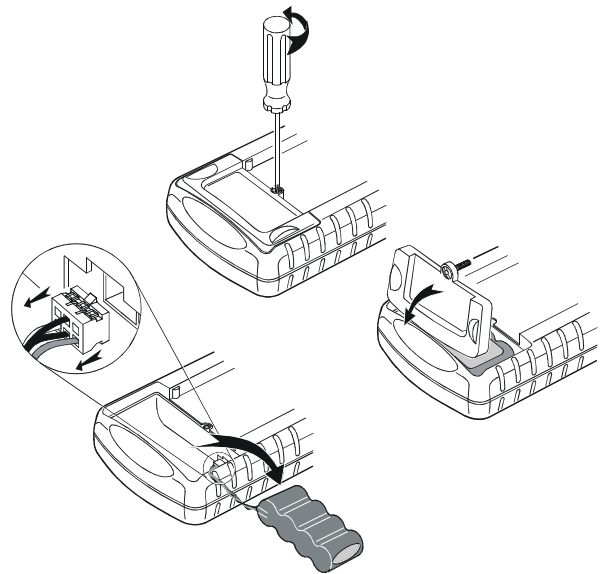

Figure 2-2. Replacing the Battery Pack

Note

Ensure that the battery pack is placed in the battery compartment as shown in Figure 2-2. For Fluke 123 use the Fluke BP120 Ni-Cd (standard) or BP130 Ni-MH (extended operating time) battery pack. For Fluke 124 it is recommended to use the Fluke BP130 Ni-MH battery pack .

8. Reinstall the battery cover and secure the screw.

Using and Adjusting 10:1 Scope Probes

Note

The 10:1 voltage probe that is supplied with Fluke 124 is always adjusted correctly to the Test Tool and needs no further adjustment.

You need to adjust other scope probes (e.g. VPS100, optional) for optimal response.

Warning

To avoid electrical shock use the BB120 Banana-to-BNC adapter (delivered with the test tool) to connect a 10:1 scope probe to the input of the test tool.

To adjust probes, do the following:

- Connect the 10:1 scope probe from the gray input B jack to the red input A jack. Use the red 4-mm banana adapter (delivered with the probe) and the banana-to-BNC adapter (BB120). See Figure 2-3.

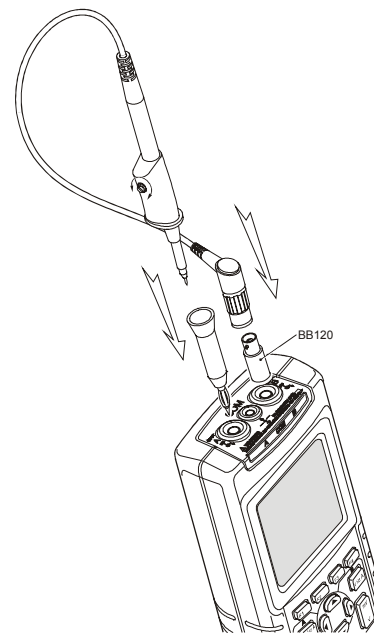





Figure 2-3. Adjusting Scope Probes

①  Open the SCOPE INPUTS menu.

②  Open the PROBES submenu.

SCOPE OPTIONS... BACK... TRIGGER... ENTER

③  Highlight PROBE AC ADJUST.

④  Open the PROBE AC ADJUST submenu.

ENTER

⑤  Highlight ADJUST 10:1 PROBE.



⑥  A square wave appears on the screen.

⑦ Adjust the trimmer screw in the probe housing to give an optimum square wave.

⑧  Return to normal mode.

Calibrating the Test Tool

You can ask for the model identity (version and calibration data) at any time. To display the identity, do the following:

①		Open the USER OPTIONS menu.
②		Open the VERSION&CALIBRATION submenu.
		

The screen gives you information about the model number with software version, the calibration number with latest calibration date, and the latest battery refresh date.

③		Return to normal mode.
---	---	------------------------

Recalibration must be carried out by qualified personnel only. Contact your local Fluke representative for recalibration.

Parts and Accessories

Service Manual



Ordering Number: 4822 872 05389

Standard Accessories





The next tables list the user-replaceable parts for the various test tool models. To order replacement parts, contact your nearest service center.

Fluke 123/124
Users Manual

Standard Accessories (cont)

Item	Ordering Code
Ni-Cd Battery Pack (installed in Fluke 123, 123/S)	BP120
Ni-MH Battery Pack (installed in Fluke 124, 124/S)	BP130
Power Adapter/Battery Charger, available models: Universal Europe 230V, 50Hz North America 120V, 60Hz  United Kingdom 240V, 50Hz Japan 100V, 60Hz Australia 240V, 50Hz Universal 115V/230V *  <i>* UL listing applies to PM8907/808 with UL listed line plug adapter for North America. The 230 V rating of the PM8907/808 is not for use in North America. For other countries, a line plug adapter complying with the applicable National Requirements must be used.</i>	PM8907/801 PM8907/803 PM8907/804 PM8907/806 PM8907/807 PM8907/808
Set of two Shielded Test Leads (Red and Gray), designed for use only with the Fluke ScopeMeter 120 series test tool.  Set contains the following replaceable part: Ground Lead with Alligator Clip (Black)	STL120 5322 320 11354

Standard Accessories (cont)

Item	Ordering Code
Test Lead for Grounding (Black) 	TL75
Set of two Hook Clips (Red and Gray) 	HC120
Set of three Alligator Clips (Red, Gray, and Black)	AC120
One Banana-to-BNC Adapter (Black). Supplied with: Fluke 123, 124 	BB120 (Set of two)
Two Banana-to-BNC Adapters (Black). Supplied with: Fluke 123/S, 124/S 	BB120 (set of two)
Getting Started Manual (English, German, French, Spanish)	4822 872 30711
Getting Started Manual (French, Spanish, Portuguese, Italian, Dutch, Danish, Norwegian, Swedish, Finnish, Russian)	4822 872 30712
Getting Started Manual (English, Chinese, Japanese, Korean)	4822 872 30713
CD-ROM with Users Manual (All languages)	4022 240 12370

Optional Accessories

Item	Ordering Code
Software & Cable Carrying Case Kit (Supplied with Fluke 123/S, 124/S) Set contains the following parts: Optically Isolated RS-232 Adapter/Cable Hard Carrying Case. Supplied with Fluke 123/S, 124/S FlukeView [®] ScopeMeter [®] Software for Windows [®]	SCC 120 PM9080 C120 SW90W
10:1 Scope Probe VP40. Supplied with Fluke 124, 124/S 	VPS40 (Set of two)
Optically Isolated RS-232 Adapter/Cable.	PM9080
Hard Carrying Case.	C120
Compact Soft Case	C125
Soft Carrying Case	C789
Isolated Trigger Probe	ITP120
Print Adapter Cable for Parallel Printers	PAC91

Chapter 3 Tips and Troubleshooting

Goal of this Chapter

This Chapter gives you information and tips on how you can make the best use of the test tool.

Using the Tilt Stand

The test tool is equipped with a tilt stand, allowing viewing from an angle. You can also use the tilt stand to hang the test tool at a convenient viewing position. Simply tilt the stand and hang the test tool. Typical positions are shown in Figure 3-1.

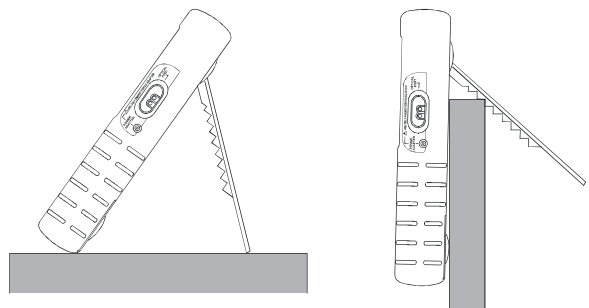





Figure 3-1. Using the Tilt Stand

Resetting the Test Tool

Perform a Master Reset to make sure that your test tool is in the initial settings condition.

- ①  Turn the test tool off.
- ②  Press and hold.
- ③  Press and release.



The test tool turns on, and you should hear a double beep, indicating the Reset was successful.



- ④  Release.

Changing the Information Language

When you operate the test tool, messages appear on the bottom of the screen. These messages are always displayed in a box, and can in some test tool versions be displayed in more languages. In different combinations, you can choose from 10 languages: English, French, German, Italian, Spanish, Portuguese, Dutch, Japanese, Korean, and Chinese.

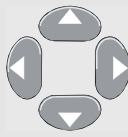

If you want to change the language of the messages into e.g. Italian, do the following:

- ①  Open the USER OPTIONS menu.
- ②  Open the LANGUAGE SELECT submenu.





The screenshot shows a menu titled 'LANGUAGE SELECT' with a list of languages: ENGLISH, FRANÇAIS, DEUTSCH, ESPAÑOL, PORTUGUÊS, ITALIANO, NEDERLANDS, 中文, 日本語, and 한국어. 'ITALIANO' is highlighted with a black bar. At the bottom of the menu are buttons for 'BATTERY REFRESH..', 'BACK...', 'VERSION & CAL...', and 'ENTER'.
- ③  Highlight ITALIANO.
- ④  Accept ITALIANO (Italian) as language.

Changing the Display

Adjusting the Screen Contrast in Fluke 123

- ①  From the main menu, choose CONTRAST.
- ②  Adjust the contrast of the screen.

Adjusting the Screen Contrast in Fluke 124





- ①  Switch from cursor control to display control.
- ②  From the display control menu, choose CONTRAST
- ③  Adjust the contrast of the screen.

Note

The new contrast adjustment of the screen is saved in memory until a new adjustment is made.

Setting the Grid Display

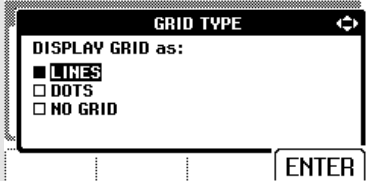
To choose a dotted grid, do the following:

- ①  Open the USER OPTIONS menu.
- ②  Highlight GRID TYPE.
- ③  Open the GRID TYPE submenu.

- ④  Choose DOTS.
- ⑤  Accept the new grid display.

Use LINES when you need a cross hatch pattern based on the horizontal time and vertical divisions on the screen. Use DOTS when you need vertical and horizontal division dots as added reference points to the screen.

Changing Date and Time

The test tool has a date and time clock. To change the date to (e.g.) 20 June, 2002, do the following:

①  Open USER OPTIONS menu.



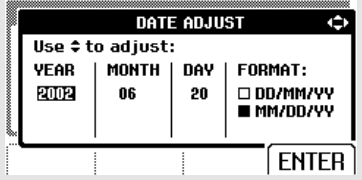

②  Highlight DATE ADJUST.

③  Open DATE ADJUST submenu.





④  Choose 2002.

⑤  Jump to MONTH.

⑥  Choose 06.

⑦  Jump to DAY.

⑧  Choose 20.

⑨  Jump to FORMAT.

⑩  Choose DD/MM/YY.

⑪  Accept the new date.

You can change the time in a similar way by opening the TIME ADJUST submenu. (steps ② and ③.)

Saving Battery Life

When operated on the battery pack (no Power Adapter connected), the test tool conserves power by shutting itself down. If you have not pressed a key for at least 30 minutes, the test tool turns itself off automatically.



Note



If the Power Adapter is connected, there is no automatic power shutdown.

Although automatic power shutdown will not occur if TrendPlot is on, the backlight will dim. Recording will continue even if the battery pack is low, and retention of memories is not jeopardized.

Setting the Power Down Timer

To extend battery life, the power shutdown time is set to 30 minutes after the last key press. To set the power shutdown to five minutes, do the following:

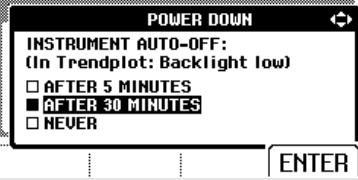
- ①  Open the USER OPTIONS menu.
- ②  Highlight POWER DOWN ...

- ③  Open the submenu.

- ④  Highlight AFTER 5 MIN.
- ⑤  Accept the new power down time.





Changing the Auto Set Options



Normally, the Auto Set function captures waveforms from 15 Hz.

To configure Auto Set for waveforms from 1 Hz with unchanged input coupling, do the following:

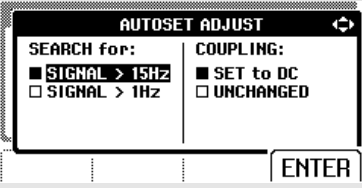
Note

Setting the Auto Set adjust to 1 Hz will slow down the Auto Set response.

①		Open the User Options menu.
②		Highlight AUTOSET ADJUST...
③		Open the AUTOSET ADJUST submenu.
		
④		Highlight SIGNALS > 1 Hz.
⑤		Select COUPLING.



⑥		Highlight UNCHANGED.
⑦		Accept the new Auto Set configuration.

Using Proper Grounding

Incorrect grounding can cause various problems. This Section gives you guidelines for proper grounding.

- Use the short ground lead(s) when measuring DC or AC signals on input A and input B. (See Figure 3-2.)

Warning

To avoid electrical shock or fire, use only one COM (common) connection , or ensure that all connections to COM  are at the same potential.

- Use the unshielded black ground lead to COM (common) for Ohm (Ω), Continuity, Diode, and Capacitance measurements. (See Figure 3-3.)

Using the unshielded ground lead is also possible for single or dual input measurements for waveforms with a frequency up to 1 MHz. This may add some hum or noise to the waveform display due to the unshielded ground lead.

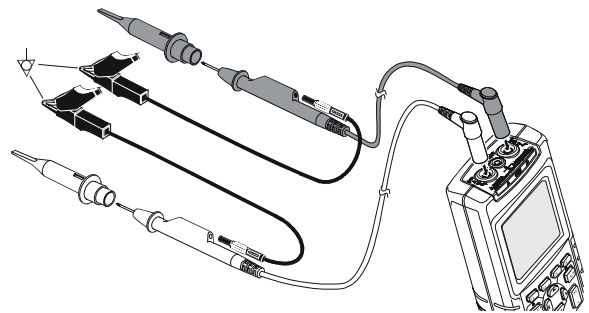

Figure 3-2. Grounding with Short Ground Lead

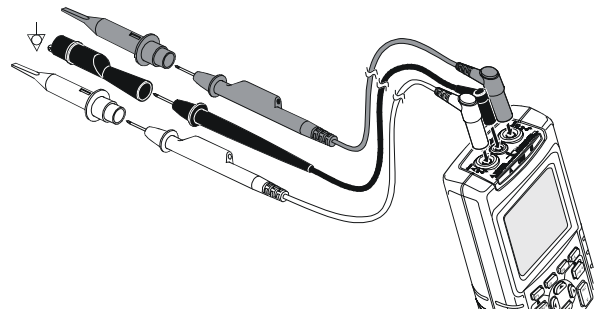

Figure 3-3. Grounding with Unshielded Ground Lead

Solving Printing and Other Communication Errors

RS-232 communication may cause problems. When experiencing communication problems, try the following remedies:

- Make sure that the interface cable is connected to the correct port on the printer or computer. If necessary use the 9 pin to 25 pin adapter or gender changer.
- Make sure that you have selected the correct printer type. (To select printer type, see Chapter 1.)
- Make sure that the baud rate matches with the printer or computer. (To set the baud rate, see Chapter 1.)
- Reset the RS-232 parameters to defaults.

Battery Testing of Fluke Accessories

When using battery operated Fluke accessories, always check the battery condition of the accessory first on a **Fluke multimeter** .

Chapter 4

Specifications

Introduction

Performance Characteristics

FLUKE guarantees the properties expressed in numerical values with the stated tolerance. Specified non-tolerance numerical values indicate those that could be nominally expected from the mean of a range of identical ScopeMeter test tools.

Environmental Data

The environmental data mentioned in this manual are based on the results of the manufacturer's verification procedures.

Safety Characteristics

The test tool has been designed and tested in accordance with Standards ANSI/ISA S82.01-1994, EN 61010.1 (1993) (IEC 1010-1), CAN/CSA-C22.2 No.1010.1-92 (including approval), UL3111-1 (including approval) Safety Requirements for Electrical Equipment for Measurement, Control, and Laboratory Use.

This manual contains information and warnings that must be followed by the user to ensure safe operation and to keep the instrument in a safe condition. Use of this equipment in a manner not specified by the manufacturer may impair protection provided by the equipment.

Dual Input Oscilloscope

Vertical

Frequency Response

DC Coupled:

- excluding probes and test leads (via BB120):.....
 - Fluke 123: DC to 20 MHz (-3 dB)
 - Fluke 124: DC to 40 MHz (-3 dB)
- with STL120 1:1 shielded test leads:
 - DC to 12.5 MHz (-3 dB)
 - DC to 20 MHz (-6 dB)
- with VP40 10:1 probe:.....
 - Fluke 123 (optional accessory): DC to 20 MHz (-3 dB)
 - Fluke 124 (standard accessory): DC to 40 MHz (-3 dB)

AC Coupled (LF roll off):

- excluding probes and test leads..... <10 Hz (-3 dB)
- with STL120 <10 Hz (-3dB)
- with 10 M Ω 10:1 Probe <1 Hz (-3 dB)

Rise Time

- excluding probes, test leads (Fluke 123) <17.5 ns
- excluding probes, test leads (Fluke 124) <8.75 ns

Input Impedance

- excluding probes and test leads..... 1 M Ω //12 pF
- with BB120 1 M Ω //20 pF
- with STL120..... 1 M Ω //225 pF
- with VP40 10:1 Probe..... 5 M Ω //15.5 pF

Sensitivity..... 5 mV to 500 V/div

Display Modes A, -A, B, -B

Max. Input Voltage A and B

- direct, with test leads, or with VP40 Probe 600 Vrms
 - with BB120 300 Vrms
- (For detailed specifications, see "Safety", Figs. 4-1/4-2)

Max. Floating Voltage

- from any terminal to ground 600 Vrms
- up to 400 Hz

Resolution..... 8 bit

Vertical Accuracy $\pm(1\% + 0.05 \text{ range/div})$

Max. Vertical Move ± 4 divisions

Horizontal

Scope Modes Normal, Single, Roll

Ranges

Normal:

- equivalent sampling (Fluke 123) 20 ns to 500 ns/div
- equivalent sampling (Fluke 124) 10 ns to 500 ns/div
- real time sampling 1 μ s to 5 s/div
- Single (real time) 1 μ s to 5 s/div
- Roll (real time) 1s to 60 s/div

Sampling Rate (for both channels simultaneously)

Equivalent sampling (repetitive signals)
up to 1.25 GS/s

Real time sampling:

- 1 μ s to 5 ms/div 25 MS/s
- 10 ms to 60 s/div 5 MS/s

Time Base Accuracy

- Equivalent sampling $\pm(0.4\% +0.04 \text{ time/div})$
- Real time sampling $\pm(0.1\% +0.04 \text{ time/div})$

Glitch Detection $\geq 40 \text{ ns @ } 20 \text{ ns to } 5 \text{ ms/div}$
 $\geq 200 \text{ ns @ } 10 \text{ ms to } 60 \text{ s/div}$
 Glitch detection is always active.

Horizontal Move 10 divisions
 Trigger point can be positioned anywhere across the screen.

Trigger

Screen Update Free Run, On Trigger

Source A, B, EXT
 EXTernal via optically isolated trigger probe ITP120
(optional accessory)

Sensitivity A and B (Fluke 123)

- @ DC to 5 MHz 0.5 divisions or 5 mV
- @ 25 MHz 1.5 divisions
- @ 40 MHz 4 divisions

Sensitivity A and B (Fluke 124)

- @ DC to 5 MHz 0.5 divisions or 5 mV
- @ 40 MHz 1.5 divisions
- @ 60 MHz 4 divisions

Slope Positive, Negative

Video on A interlaced video signals only
 Modes Lines, Line Select
 Standards PAL, NTSC, PAL+, SECAM
 Polarity Positive, Negative
 Sensitivity 0.6 divisions sync.

Advanced Scope Functions

Display Modes

Normal.....Captures up to 40 ns glitches and displays analog-like persistence waveform.

Smooth.....Suppresses noise from a waveform.

EnvelopeRecords and displays the minimum and maximum of waveforms over time.

Auto Set

Continuous fully automatic adjustment of amplitude, time base, trigger levels, trigger gap, and hold-off.

Manual override by user adjustment of amplitude, time base, or trigger level.

Accuracy:

- @1 Hz to 1 MHz $\pm(0.5\% + 2 \text{ counts})$
- @1 to 10 MHz $\pm(1.0\% + 2 \text{ counts})$
- @10 to 50 MHz (Fluke 123) $\pm(2.5\% + 2 \text{ counts})$
- @10 to 70 MHz (Fluke 124) $\pm(2.5\% + 2 \text{ counts})$
(50 MHz in Autorange)
- Full Scale Reading 10 000 counts

Duty Cycle (DUTY)

- Range 2% to 98%
- Frequency Range in Continuous Autosest
15 Hz (1 Hz) to 30 MHz
- Accuracy (Logic or Pulse waveforms):
- @1Hz to 1 MHz $\pm(0.5\% + 2 \text{ counts})$
- @1 MHz to 10 MHz $\pm(1.0\% + 2 \text{ counts})$

Pulse Width (PULSE)

- Frequency Range in Continuous Autosest
15 Hz (1 Hz) to 30 MHz
- Accuracy (Logic or Pulse waveforms):
- @1 Hz to 1 MHz $\pm(0.5\% + 2 \text{ counts})$
- @1 MHz to 10 MHz $\pm(1.0\% + 2 \text{ counts})$
- Full Scale Reading 1000 counts

- Amperes (AMP)** with optional current probe
- Ranges same as VDC, VAC, VAC+DC, or PEAK
- Scale Factor ... 1 mV/A, 10 mV/A, 100 mV/A, and 1 V/A

- Accuracy same as VDC, VAC, VAC+DC, or PEAK
(add current probe uncertainty)

- Temperature (TEMP)** ... with optional temperature probe
- Range 200 °C/div (200 °F/div)
- Scale Factor 1 mV/°C and 1 mV/°F
- Accuracy as VDC (add temp. probe uncertainty)

Decibel (dB)

- 0 dBV 1V
- 0 dBm (600Ω /50Ω) 1 mW
referenced to 600Ω or 50Ω
- dB on VDC, VAC, or VAC+DC
- Full Scale Reading 1000 counts

Crest Factor (CREST)

- Range 1 to 10
- Accuracy $\pm(5\% + 1 \text{ count})$
- Full Scale Reading 100 counts

Phase

- Modes A to B, B to A
- Range 0 to 359 degrees
- Accuracy up to 1 MHz 2 degrees
- Accuracy 1 MHz to 5 MHz 5 degrees
- Resolution 1 degree

Advanced Meter Functions

Zero Set

Set actual value to reference

Fast/Normal/Smooth

Meter settling time Fast: 1s @ 1 μ s to 10 ms/div.
Meter settling time Normal: 2s @ 1 μ s to 10 ms/div.
Meter settling time Smooth: 10s @ 1 μ s to 10 ms/div.

Touch Hold (on A)

Captures and freezes a stable measurement result.
Beeps when stable. Touch Hold works on the main meter reading, with thresholds of 1 Vpp for AC signals and 100 mV for DC signals.

TrendPlot

Graphs meter readings of the Min and Max values from 15 s/div (120 seconds) to 2 days/div (16 days) with time and date stamp. Automatic vertical scaling and time compression.
Displays the actual and Minimum, Maximum, or average (AVG) reading.

Fixed Decimal Point

Possible by using attenuation keys.

Cursor readout (Fluke 124)

Sources:

A, B

Single Vertical Line:

Average, Min and Max Readout
Average, Min, Max and Time from Start of Readout (in ROLL mode; instrument in HOLD)
Min, Max and Time from Start of Readout (in TRENDPLOT mode; instrument in HOLD)

Dual Vertical Lines:

Peak-Peak, Time Distance and Reciprocal Time Distance Readout
Average, Min, Max and Time Distance Readout (in ROLL mode; instrument in HOLD)

Dual Horizontal Lines:

High, Low and Peak-Peak Readout

Rise or Fall Time:

Transition Time, 0%-Level and 100%-Level Readout (Manual or Auto Leveling; Auto Leveling only possible in Single Channel Mode)

Accuracy:

As Oscilloscope Accuracy

Miscellaneous

Display

- Size 72 x 72 mm (2.83 x 2.83 in)
- Resolution 240 x 240 pixels
- Waveform Display:
 - Vertical 8 div of 20 pixels
 - Horizontal 9.6 div of 25 pixels
- Backlight..... Cold Cathode Fluorescent (CCFL)

⚠ Power

- External: via Power Adapter PM8907
- Input Voltage 10 to 21V DC
- Power 5W typical
- Input Connector..... 5 mm jack
- Fluke 123 (Internal Battery Pack BP120):
 - Battery Power Rechargeable Ni-Cd 4.8V
 - Operating Time..... 4 hours with bright backlight
4.25 hours with dimmed backlight
 - Charging Time 5 hours with test tool off
40 hours with test tool on
9 .. 14 hours with refresh cycle
- Fluke 124 (Internal Battery Pack BP130):
 - Battery Power Rechargeable Ni-MH 4.8V
 - Operating Time..... 6 hours with bright backlight
6.30 hours with dimmed backlight
 - Charging Time 7 hours with test tool off
60 hours with test tool on
12 .. 19 hours with refresh cycle

Allowable ambient temperature:
during charging 0 to 45 °C (32 to 113 °F)

Memory

- Number of Screen + Setup Memories (Fluke 123) 10
- Number of Screen + Setup Memories (Fluke 124) 20

Mechanical

- Size..... 232 x 115 x 50 mm (9.1 x 4.5 x 2 in)
- Weight 1.2 kg (2.5 lbs)
including battery pack

Interface

- RS-232, optically isolated
- To Printer..... supports Epson FX, LQ, and
HP Deskjet®, Laserjet®, and Postscript
- Serial via PM9080 (optically isolated RS-232
adapter/cable, optional).
- Parallel via PAC91 (optically isolated print adapter
cable, optional).
- To PC Dump and load settings and data
- Serial via PM9080 (optically isolated RS-232
adapter/cable, optional), using SW90W (FlukeView®
software for Windows®).

Environmental

Environmental MIL-PRF-28800F, Class 2

Temperature

Operating 0 to 50 °C (32 to 122 °F)
Storage -20 to 60 °C (-4 to 140 °F)

Humidity

Operating:
 @0 to 10 °C (32 to 50 °F) noncondensing
 @10 to 30 °C (50 to 86 °F) 95%
 @30 to 40 °C (86 to 104 °F) 75%
 @40 to 50 °C (104 to 122 °F) 45%
 Storage:
 @-20 to 60 °C (-4 to 140 °F) noncondensing

Altitude

Operating 4.5 km (15 000 feet)
 Max. Input and Floating Voltage 600 Vrms upto 2 km,
 linearly derating to 400 Vrms @ 4.5 km
 Storage 12 km (40 000 feet)

Vibration (sinusoidal)
 MIL28800F, class 2, 3.8.4.2, 4.5.5.3.1: Max. 3g

Shock
 MIL28800F, class 2, 3.8.5.1, 4.5.5.4.1: Max. 30g

Electromagnetic Compatibility (EMC)

Emission EN 50081-1 (1992):
 EN55022 and EN60555-2

Immunity EN 50082-2 (1992):
 IEC1000-4-2, -3, -4, -5
 (See also Tables 1 to 3)

Enclosure Protection IP51, ref: IEC529

Safety

Designed for measurements on 600 Vrms Category III
 Installations, Pollution Degree 2, per:

- ANSI/ISA S82.01-1994
- EN61010-1 (1993) (IEC1010-1)
- CAN/CSA-C22.2 No.1010.1-92 (including approval)
- UL3111-1 (including approval)

Max. Input Voltage Input A and B

Direct on input or with leads 600 Vrms
 for derating, see Figure 4-1.
 With Banana-to BNC Adapter BB120 300 Vrms
 for derating, see Figure 4-1.

Max. Floating Voltage

from any terminal to ground 600 Vrms
 up to 400 Hz

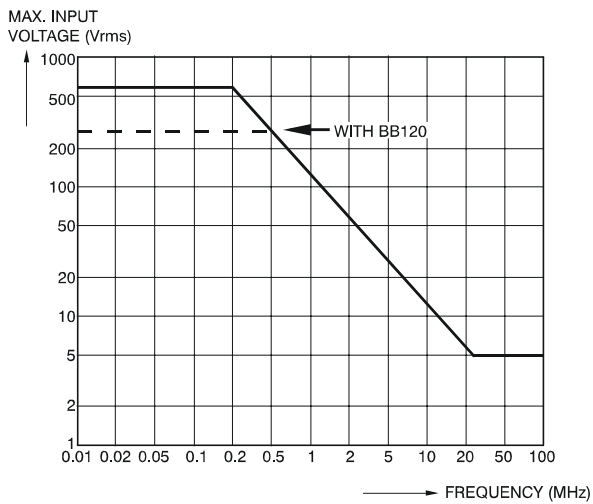

Figure 4-1. Max. Input Voltage v.s. Frequency for BB120 and STL120

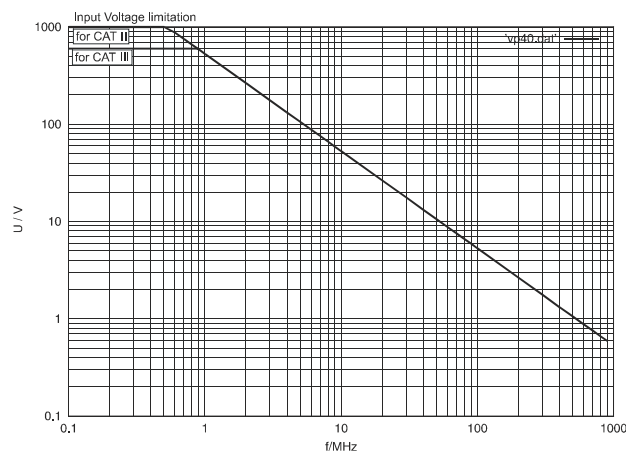

Figure 4-2. Max. Input Voltage v.s. Frequency for VP40 10:1 Voltage Probe

The Fluke 123/124, including standard accessories, conforms with the EEC directive 89/336 for EMC immunity, as defined by IEC1000-4-3, with the addition of the following tables.

Trace disturbance with STL120

Table 1

No visible disturbance	E= 3 V/m	E= 10 V/m
Frequency range 10 kHz to 27 MHz Frequency range 27 MHz to 1 GHz	100 mV/div to 500 V/div 100 mV/div to 500 V/div	500 mV/div to 500 V/div 100 mV/div to 500 V/div

Table 2

Disturbance less than 10% of full scale	E= 3 V/m	E= 10 V/m
Frequency range 10 kHz to 27 MHz Frequency range 27 MHz to 1 GHz	20 mV/div to 50 mV/div 10 mV/div to 20 mV/div	100 mV/div to 200 mV/div -

(-): no visible disturbance

Test tool ranges not specified in tables 1 and 2 may have a disturbance of more than 10% of full scale.

Multimeter disturbance:

- **VDC, VAC, and VAC+DC with STL120 and short ground lead.**
- **OHM, CONT, DIODE, and CAP with STL120, and black test lead to COM.**

Table 3

Disturbance less than 1% of full scale	E= 3 V/m	E= 10 V/m
Frequency range 10 kHz to 27 MHz VDC, VAC, VAC+DC OHM, CONT, DIODE CAP	500 mV to 1250V 500Ω to 30 MΩ 50 nF to 500 μF	500 mV to 1250V 500Ω to 30 MΩ 50 nF to 500 μF
Frequency range 27 MHz to 1 GHz VDC, VAC, VAC+DC OHM, CONT, DIODE CAP	500 mV to 1250V 500Ω to 30 MΩ 50 nF to 500 μF	500 mV to 1250V 500Ω to 30 MΩ 50 nF to 500 μF

Test tool ranges not specified in table 3 may have a disturbance of more than 10% of full scale.

Index

—A—

AC coupling, 4
AC120 Alligator Clips, 51
Accessories, 49
AC-Coupling, 26
Acquiring the Waveform, 23
Acquisition Modes, 63
Adjusting Scope Probes, 47
Advanced Meter Functions, 68
Advanced Scope Functions, 64
Alligator Clips, 51
Altitude, 70
Amperes Measurement, 66
Amplitude, 18
Auto Set, 64
Auto Set Configuration, 58

Automatic Power Shutdown, 57
Avoid Electrical Shock, 12

—B—

Backlight, 9
Banana Jack Inputs, 12
Banana-to-BNC Adapter, 51
Bandwidth, 62
Battery Charger, 50
Battery Disposing, 46
Battery Indicator, 10
Battery Life, 57
Battery Pack, 2, 44, 50
Battery Power, 69
Battery Refresh Date, 49
Battery Replacing, 46
BB120 Adapters, 51

Blue Function Keys, 10
BP120 Battery Pack, 47, 50
BP130 Battery Pack, 47, 50
Bright Display, 9

—C—

C120 Hard Case, 52
C125 Compact Soft Case, 52
C789 Soft Case, 52
Calibrating the Test Tool, 49
Capacitance, 14, 59, 67
Case, 52
Changing the Amplitude, 18
Changing the Display, 55
Changing the Graphic Representation, 18
Changing the Time Base, 18

Charge Time, 69
Charger, 50
Charging, 44
Cleaning, 43
Common, 12
Communication Errors, 60
Compact Soft Case, 52
Computer, 41
Connect-and-View function, 13
Connecting a Computer, 42
Continuity, 14, 59, 67
Contrast, 55
Crest Factor, 66
Current Measurement, 66
Cursors, 35, 68

—D—

Date, 56
DC Voltage (VDC), 65
Decibel (dB), 66
Declaration of Conformity, 1
Deleting Screens and Setups, 34
Dimmed Display, 9
Diode, 14, 59, 67
Display, 55, 69
Disposing Batteries, 46
Duty Cycle, 66

—E—

Earth Ground, 6
Electrical Shock, 5
Electrically Floating, 6
Electromagnetic Compatibility, 1, 70
Emission, 70
Envelope, 64
Envelope of a Waveform, 21
Environmental, 70
Environmental Data, 61

—F—

Fast/Smooth, 68
Fixed Decimal Point, 68
FlukeView, 41, 52
Freeze Recording, 25
Freezing the Screen, 16
Frequency (Hz), 65
Frequency Response, 62
Function Keys, 10

—G—

Glitch Detection, 63
Graphic Representation, 18

Gray Text, 28
Grey INPUT B, 12
Grid Display, 55
ground, 6
Ground Test Lead, 51
Grounding Problems, 59

—H—

Hands-free Measurements, 16
Hard Carrying Case, 52
HC120 Hook Clips, 51
High Frequency Measurements, 38
Holding a Stable Reading, 16
Hook Clips, 51
Horizontal Cursors, 35
Horizontal Move, 63
Humidity, 70
Hz, 65

—I—

Immunity, 70
Input A, 12
Input B, 12
Input Impedance, 62
insulated
 isolated, 5

Isolated, 6
Isolated Trigger Probe, 29, 52
Isolated Triggering, 29
ITP120, 29, 52

—L—

Level, 27

—M—

Maintenance, 43
Making Measurements, 14
Manual, 51
Manual Override, 64
Max. Floating Voltage, 6, 62, 70
Max. Input Voltage, 62, 70
Maximum (MAX) Reading, 23
Measurement Connections, 12
Measurements, 14
Mechanical, 69
mechanical damage, 5
Memory, 69
Menu Area, 10
Meter A Measurement, 14
Meter B Measurement, 15
Min Max Reading, 23
Minimum (MIN) Reading, 22
Multimeter Disturbance, 73

—N—

Ni-Cd Battery Pack, 2, 44, 50
Ni-MH Battery Pack, 2, 44

—O—

Ohm (Ω), 14, 59, 67
Operating Time, 69
Optical Interface, 39, 41, 69

—P—

PAC91, 52
Parallel Print Cable, 52
Parts, 49
Peak, 65
Performance Characteristics, 61
Phase, 66
PM8907, 50
PM8918, 47
PM8918 Probe, 52, 62
PM9080, 39, 41, 52
Polarity, 26
Positioning the Waveform, 19
Power Adapter, 50, 57
Power Down Timer, 57
Powering the Test Tool, 7
Print Cable, 52

Printing, 39
Printing Errors, 60
Probe, 47, 52, 62
Probe 10
1, 38
Probe Adjustment, 39
Probe Attenuation, 38
Pulse Width, 66

—R—

Reading Area, 10, 14
Reading the Screen, 10
Recalibrating, 49
Recalling, 32
Recalling Screens and Setups, 33
Record a Waveform, 21
Recording Slow Signals, 25
Red INPUT A, 12
Refreshing the Batteries, 49
Relative Measurements, 17
Replaceable Parts, 49
Replacing Batteries, 46
Resetting, 54
Resetting the Test Tool, 8
Reversing the Polarity, 26
Rise Time, 62
Rise Time Measurements, 37
Roll Mode Function, 25

Fluke 123/124
Users Manual

RS-232 Adapter/Cable, 39, 41, 52
RS-232 Communication Errors, 60

—S—

Safety, 70
Safety Characteristics, 61
Safety Precautions, 4
Safety Requirements, 1
Sampling Rate, 63
Saving, 32
Saving Screens and Setups, 32
SCC 120, 41, 52
Scope Modes, 63
Scope Probes, 52
Screen Contrast, 55
Selecting Trigger Parameters, 28
Sensitivity, 62
Serial Printer, 40
Service Manual, 49
Shielded Test Leads, 50
Shock, 70
Single Shot, 23
Slope, 27, 63
Slow Signals, 25
Smooth, 20, 64
Soft Carrying Case, 52
Software, 52

Software Version, 49
Specifications, 61
Stable Reading, 16
Stand, 53
STL120 Test Leads, 50
Storing, 43
SW90W Software, 41, 52

—T—

Temperature Measurement, 66
Temperature, Environmental, 70
Test Leads, 50
Tilt Stand, 53
Time, 56
Time Base, 18
Time Base Accuracy, 63
Time Base Ranges, 63
Touch Hold[®] function, 16, 68
Trace Disturbance, 72
TrendPlot™ function, 68
TrendPlot™ Function, 22
Trigger, 63
Trigger Icons, 27
Trigger Level, 27
Trigger Parameters, 28
Trigger Sensitivity, 63
Triggering, 27

—U—

Unpacking, 2
User Manual, 51
Using a Printer, 39
Using FlukeView Software, 41

—V—

Vertical Accuracy, 62
Vertical Cursors, 36
Vibration, 70
Video Line, 31
Video on A, 63
Video Signals, 29
VP40 Probe, 38

—W—

Waveform Area, 10

—Z—

Zero Reference, 17

X-ON Electronics

Largest Supplier of Electrical and Electronic Components

Click to view similar products for [Benchtop Oscilloscopes](#) category:

Click to view products by [Fluke](#) manufacturer:

Other Similar products are found below :

[WSXS-RACK](#) [WSXS-MOUSE](#) [WSXS-KYBD](#) [UPO2102CS](#) [AX-DS1100CFM](#) [TT-HV250](#) [TT-LF212](#) [TT-LF 312-2-6](#) [DSO3064-KIT-IV](#)
[DSO5102P](#) [DSO5202B](#) [RT-ZP03](#) [MSO5062D](#) [CC-650](#) [FLUKE PM9082/001](#) [TOS-2020CT](#) [PK007-003](#) [PK007-019](#) [PK007-022](#) [PK007-024](#)
[PK007-026](#) [PK106-5](#) [PK116-3](#) [PK1-5MM-102](#) [PK1-5MM-104](#) [PK1-5MM-105](#) [PK1-5MM-108](#) [PK1-5MM-111](#) [PK1-5MM-112](#) [PK1-5MM-](#)
[113](#) [PK1-5MM-120](#) [TA041](#) [GDS-1052-U](#) [GDS-1072A-U](#) [GDS-1102A-U](#) [GDS-2072A](#) [GDS-2202E](#) [GDS-2204E](#) [U3400A-1CM](#) [PP-150](#) [PP-](#)
[80](#) [HO720](#) [TT-MF312](#) [TT-LF316](#) [TT-HV150](#) [TT-HF212RA](#) [TT-HF212](#) [2555](#) [2557](#) [2566](#)