

FLUKE®

High performance handheld scopes
BUILT TOUGH
to keep up with you.

New
500 MHz

20 years of ScopeMeter®
Test Tool Innovation

190 Series II ScopeMeter®
Portable Oscilloscopes



See more.
Fix more.



ScopeMeter® portable oscilloscopes take you into territory where standard bench scopes can't go: where it's harsh, hazardous and dirty—without sacrificing any capabilities.

The Fluke 190 Series II ScopeMeter® oscilloscopes, with electrically isolated channels, are safety rated for industrial applications. These scopes combine rugged portability with the high performance of bench oscilloscopes to take you from troubleshooting microelectronics all the way into power electronic applications—from dc to 500 MHz.

Choose from two or four channel models with a wide range of bandwidth options. Fast sampling rates up to 5.0 GS/s, 200 ps resolution and deep memory of 10,000 samples per channel allow high-accuracy capture and display of waveform details, noise, and other disturbances.

Perform timing or amplitude related measurements on three phases or three-axis control systems, or simply compare and contrast multiple test points in a circuit under test. Features like TrendPlot™, ScopeRecord™, and Connect-and-View™ help you quickly diagnose industrial machinery, automation and process controls, and power electronics to minimize repair costs and downtime. These features make the oscilloscopes easy to use especially when diagnosing the most difficult problems like complex waveforms, induced noise, intermittent events and signal fluctuations or drift.

New Li-Ion battery technology keeps your scope on the job, all day.

Fluke 190 Series II ScopeMeter test tools are available with two or four channels, 60 MHz to 500 MHz. Choose the model that's right for your application and budget.

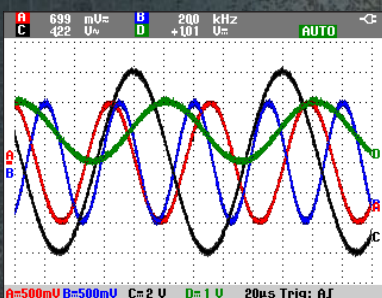

Compare waveforms and easily perform timing and amplitude measurements of 4 channels simultaneously.

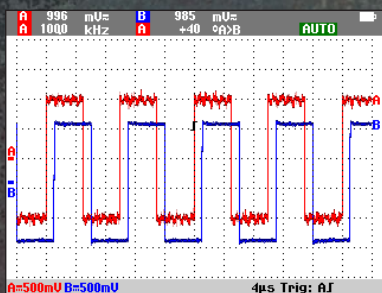

500 MHz bandwidth and 5GS/s sampling can reveal signal noise and distortion that otherwise may go undetected.

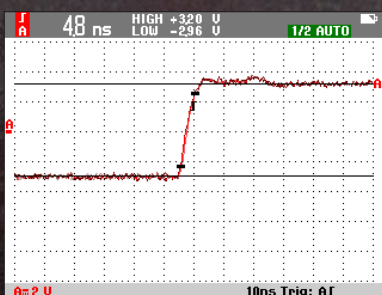

5GS/s sampling or 200 ps sample resolution provides the detail needed to inspect signal edge dV/dt or signs of destructive reflections.

Built to withstand harsh environments with the highest safety ratings

Rated all the way to CAT IV
ScopeMeter test tools are rugged solutions built for industrial troubleshooting. The new Fluke 190 Series II are double-insulated floating oscilloscopes safety rated for measurements in CAT III 1000 V/CAT IV 600 V environments.

Measure from mV to kV safely

Independent isolated inputs allow you to make measurements in mixed circuits having different ground references reducing the risk of accidental short circuits.

Conventional bench oscilloscopes without special differential probes and isolation transformers can only reference measurements to line power earth ground.

With standard probes that cover a wide application range from mV to kV, you're ready for anything from microelectronics to heavy-duty higher voltage electrical applications.

IP-51 rated for harsh environments

Rugged and shock-proof, ScopeMeter portable oscilloscopes are built for dirty, hazardous environments. With its sealed case, it can endure dust, drips, humidity and airborne pollutants. Every time you reach for ScopeMeter you can be confident it will work reliably wherever your work takes you.

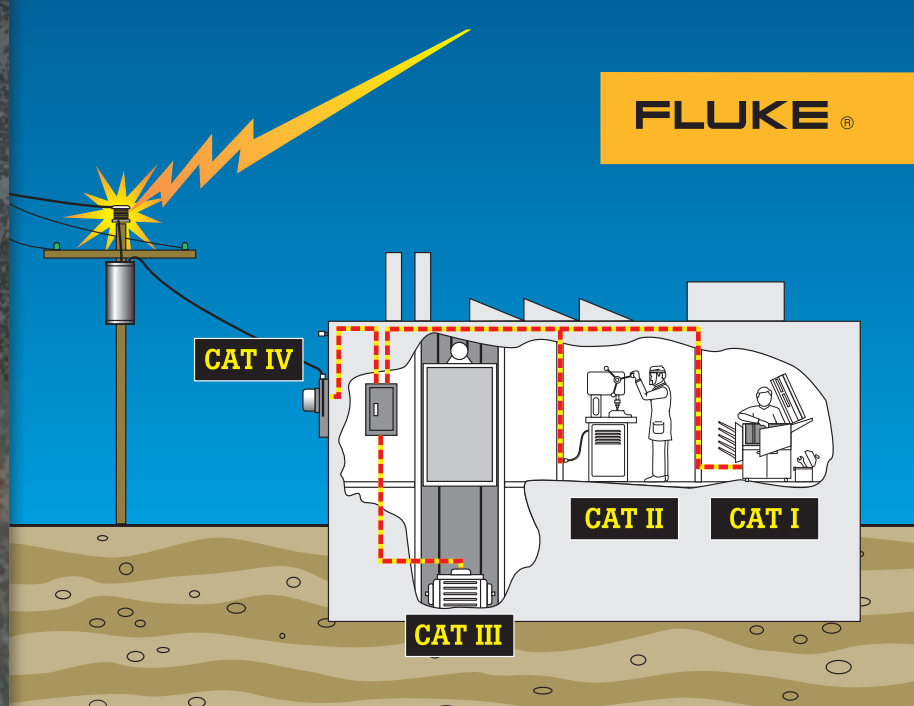

Overvoltage category	In brief	Examples
CAT IV	Three-phase at utility connection, any outdoor conductors	<ul style="list-style-type: none"> Refers to the "origin of installation," that is, where low-voltage connection is made to utility power Electricity meters, primary overcurrent protection equipment Outside and service entrance, service drop from pole to building, run between meter and panel Overhead line to detached building, underground line to well pump
CAT III	Three-phase distribution, including single-phase commercial lighting	<ul style="list-style-type: none"> Equipment in fixed installations, such as switchgear and polyphase motors Bus and feeder in industrial plants Feeders and short branch circuits, distribution panel devices Lighting systems in larger buildings Appliance outlets with short connections to service entrance
CAT II	Single-phase receptacle connected loads	<ul style="list-style-type: none"> Appliance, portable tools, and other household and similar loads Outlet and long branch circuits <ul style="list-style-type: none"> — Outlets at more than 10 meters (30 feet) from CAT III source — Outlets at more than 20 meters (60 feet) from CAT IV source
CAT I	Electronic	<ul style="list-style-type: none"> Protected electronic equipment Equipment connected to (source) circuits in which measures are taken to limit transient overvoltages to an appropriately low level Any high-voltage, low-energy source derived from a high-winding resistance transformer, such as the high-voltage section of a copier

Table 1. Overvoltage installation categories. IEC 61010 applies to *low-voltage* (< 1000 V) test equipment.

Multiply your diagnostic powers

with the new Fluke 190 Series II Portable Oscilloscopes

Introducing the scopes with CAT IV rating

The first CAT III 1000 V/CAT IV 600 V rated, two- and four-channel portable scopes on the market, the new Fluke 190 Series II brings an unprecedented combination of performance and ruggedness into the field.

Take on new challenges in industrial machinery, automation and process controls, power conversion electronics

Analyze timing and amplitude relationships of multiple signals simultaneously, easily compare and contrast waveform traces spotting irregularities with ease.

- For three-phase power applications like industrial motors and drives, UPS and inverters for wind energy, solar, and diesel locomotive controls for transportation
- For three-axis testing when you need to measure input, output and control signals simultaneously
- Power electronic devices with switching IGBT's produce pulses with fast, high voltage edges (dv/dt), the scope sample resolution is critical to accurately detecting edge rise-time and amplitude and the peak of any reflection.

The ultimate in portability

New high-performance batteries take advantage of Li-Ion technology to keep you going strong for up to seven hours. With the easy-access battery door you can make battery swaps fast.

USB connectivity makes it easy to capture and share waveforms

The new Fluke 190 Series II offers two USB ports, electrically isolated from measurement input circuits. Easily transfer data to a PC. Archive and share waveforms with OEMs, colleagues and support staff. Store waveforms, screen captures and instrument setups onto USB memory devices.

New 500 MHz



Learn more about ScopeMeter applications with the new Fluke 190 Series II.



Go to www.fluke.com/ScopeMeterSeriesII

What could you do with four channels?

Take multiple measurements simultaneously to track down the root cause of your most complex troubleshooting challenges.

Easily diagnose timing-related issues with multiple signals

- Real-time inspection of multiple related signals simultaneously
- Measure a combination of input and output signals and system safety interlocks and feedback loops

Find problems in industrial systems including:

- Circuit voltage/current overloading
- Attenuation/input impedance mismatch
- Signal fluctuation/drift
- Conditioning circuits signal integrity
- Test point verification for critical signals
- Input/output/feedback timing issues
- Induced noise and disturbances
- Random shutdowns/reset

Diagnose VSDs* or power inverters and converters

- Harmonics, transients and loads in three-phase power input
- Troubleshoot dc to ac converters for faulty control circuits or output IGBT gate stages
- Cable interface—test PWM output for reflections and transients
- Accurately measure IGBT pulse edge rise-time, amplitude and peak of reflections
- Vpwm measurement to measure the effective voltage on drive outputs

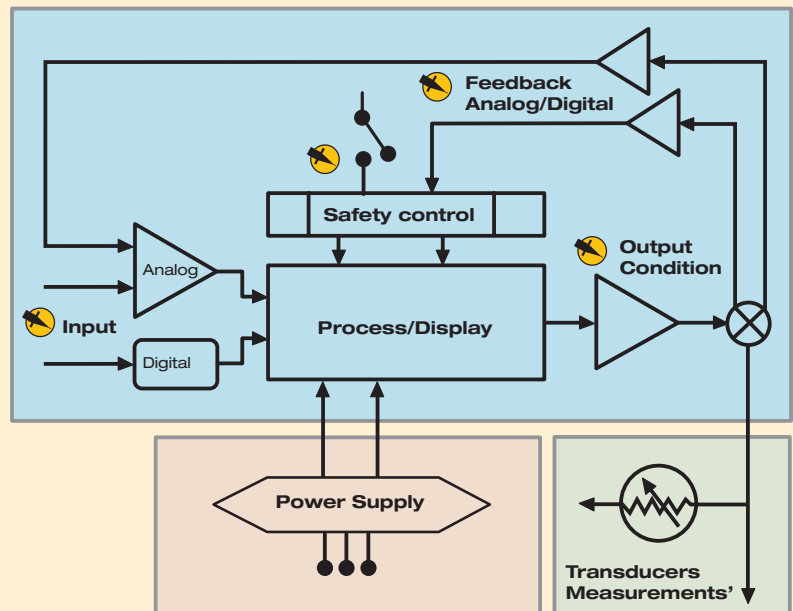

For industrial electronics, four channels allow you to perform three-dimensional testing, measuring input, output and feedback signals simultaneously.

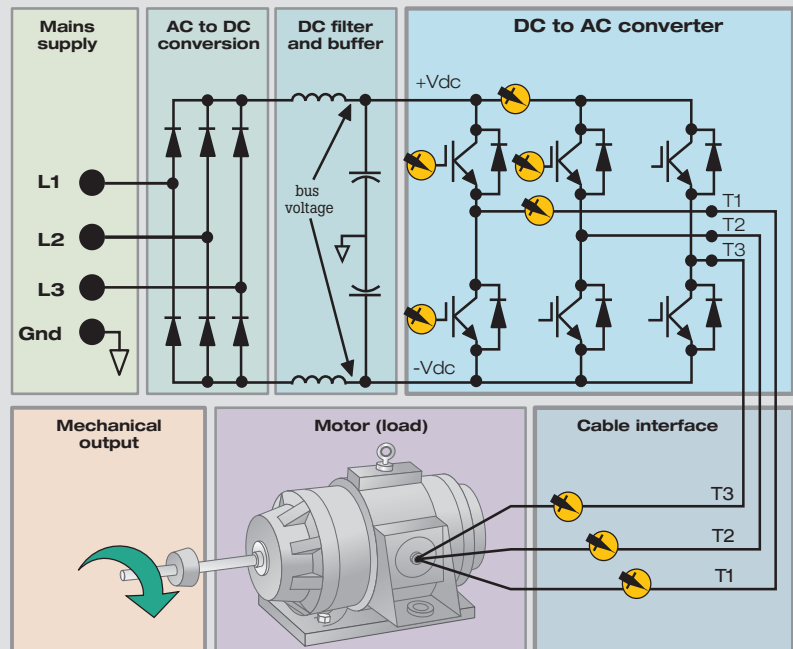

In three-phase systems like variable speed drives, UPS or back-up generators, use four channels to diagnose power input, dc to ac converters, or cable interface problems.

Fluke ScopeMeter® test tools work harder to make your job easier

See what's happening with fast real-time high resolution sampling. ScopeMeter offers a sample rate of up to 5 GS/s with up to 200 ps resolution.

Connect-and-View™ triggering for an instant, stable display

If you've used other scopes, you know how tricky triggering can be. If settings are incorrect, results can be unstable or incorrect. Connect-and-View™ automatically sets up correct triggering by recognizing signal patterns. Without touching a button, you get a stable, reliable and repeatable display of virtually any signal including motor drive and control signals. It's especially fast and convenient when you're measuring a number of test points in rapid succession.

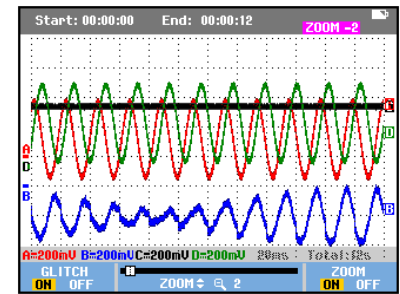

Capture high-resolution waveform details over extended period using ScopeRecord™ mode.

TrendPlot™ paperless recorder—records up to 22 days to help you find intermittent faults

The toughest faults to find are those that happen once in a while. These intermittents can be caused by bad connections, dust, dirt, corrosion, or simply broken wiring or connectors. Line outages, sags or starting and stopping of a motor can also cause a machine to stop. You may not be around when it happens, but the Fluke ScopeMeter will.

- Plot minimum and maximum peak values and average over time up to 22 days
- Plot any combination of voltages, amps, temperature, frequency and phase for all inputs, all with time and date stamp to pinpoint faults

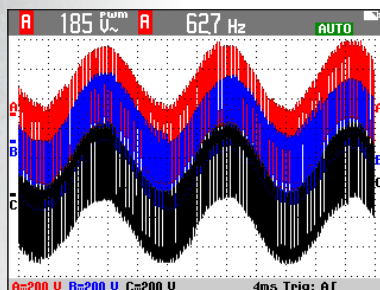

Connect-and-View™ captures even the most complex motor drive signals.

Built-in digital multimeter

Conveniently switch from waveform analysis to precise multimeter measurements using the built in 5000 count digital multimeter. Measurement functions include Vdc, Vac, Vac+dc, resistance, continuity and diode test. Measure current and temperature using suitable shunt, probe or adapter with wide range of scaling factors.

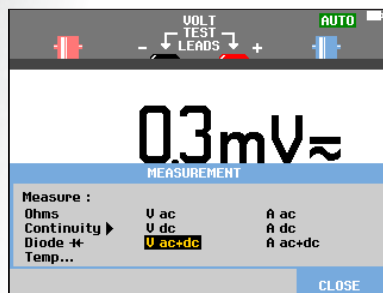

The built in multimeter provides convenient precision measurements.

ScopeRecord™ mode for high resolution waveform recording up to 48 hours

ScopeRecord™ memory stores up to 30,000 or more data points per channel, capturing fast intermittents and glitches as short as 8 ns. (Two sets of multiple-channel recordings can be stored for later analysis.)

- Records events like motion profiles and UPS, power supply or motor start-up cycles
- With the Stop on Trigger mode, the ScopeMeter automatically recognizes a power failure and stores the waveform data preceding it

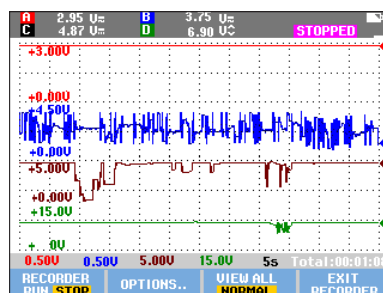

Trend multiple measurements capturing signal intermittent events, signal drift or fluctuations.





Conveniently store and transfer critical waveform data using isolated USB ports.

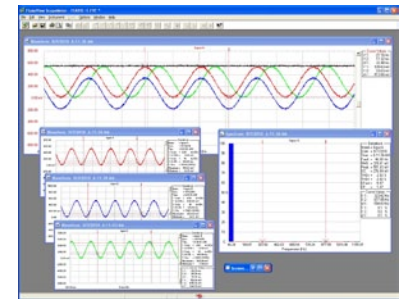

Persistence, FFT, mathematics and pass/fail waveform envelope testing

Pass/Fail testing of actual signal against a reference template.

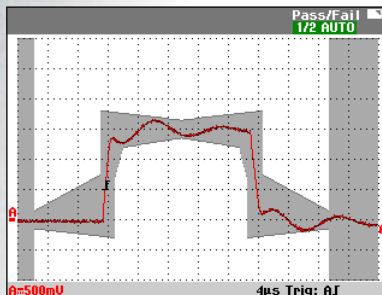

Digital Persistence mode gives analog scope-like display of complex and

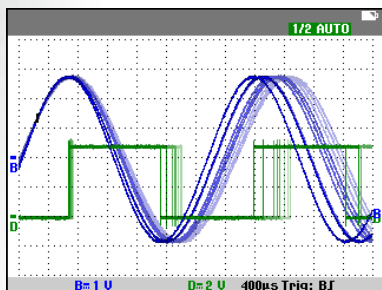

Frequency Spectrum shows an overview of frequencies contained in a signal.

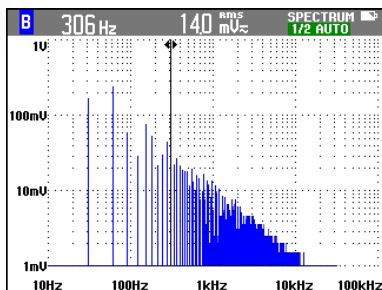

Look back in time with automatic capture and display of last 100 screens

It's frustrating to see a one-time anomaly flash and miss it. Fluke ScopeMeter solves the problem by letting you look back in time with a touch of the replay button.

- In normal use, the instrument continuously memorizes the last 100 screens. As each new screen is acquired, the oldest is discarded.
- At any moment you can "freeze" the last 100 screens and scroll through picture-by-picture or replay as a "live" animation
- Use cursors for further analysis
- Advanced triggering lets you capture up to 100 specific events (Two sets of 100 captured screens with individual time stamps can be stored for later recall or downloaded to a PC or USB stick.)

FlukeView® ScopeMeter software for documenting, archiving and analysis

Get more out of your ScopeMeter with FlukeView® ScopeMeter® SW90W Software for Windows.

- Documentation—transfer waveforms, screens and data to your PC for printing or importing data into a report
- Add text to ScopeMeter settings—give operators guidance when recalling settings
- Archive—create a library of waveforms for easy reference, waveform comparison, or pass/fail testing
- Analysis—use cursors, perform spectrum analysis or export data to another analysis program
- Connect to your PC with optically isolated USB port

Cursors and automatic waveform measurements

With 30 automatic measurements, cursors, and zoom, ScopeMeter will perform automatic power and Vrms measurements on specific portion of the waveform within a specified time span.

Time Stamp

Real-time clock allows you to find out when a specific event was recorded.

A broad family of ScopeMeter® models

Choose the model that fits your applications and budget. Fluke offers the broadest range of bandwidths in portable oscilloscopes—from 20 MHz to 500 MHz.



ScopeMeter 190 Series II: Be prepared for anything in a CAT IV world with three-axis and three-phase testing.

- 190-XX4 model with four independent isolated inputs
- 190-XX2 models with two independent isolated scope inputs and DMM input
- Choose 60 MHz, 100 MHz, 200 MHz or 500 MHz bandwidth
- Fast sample rate: up to 5 GS/s with up to 200 ps resolution
- Single shot, pulse width and video triggering
- Deep memory: 10,000 point per trace waveform capture
- CAT III 1000 V/CAT IV 600 V, safety rated
- Up to seven hours of operation with high-performance Li-Ion batteries
- Battery door for conveniently swapping out batteries to extend usage time plus optional external charger
- Two isolated USB ports, for memory devices and PC connectivity
- Security slot to lock down instrument using standard Kensington® lock
- Plus all the standard features of ScopeMeter including TrendPlot™, Connect-and-View™ triggering and ScopeRecord™

ScopeMeter 120 Series: Three-in one simplicity for electrical or electromechanical troubleshooting.

- It's an oscilloscope, a multimeter and a paperless recorder in one affordable, easy-to-use instrument
- Dual input
- Up to seven hours of battery operation
- CAT III 600 V safety rated
- Automatic measurements
- Choice of 40 MHz or 20 MHz bandwidth
- Two 5,000 count true-rms digital multimeters
- Includes standard ScopeMeter features like Connect-and-View™ and TrendPlot™ recording
- Model 125 offers network bus health and power measurements for industrial systems testing



Industry applications

	Industrial		Industrial Electronics			Electronic Field Service		
Technologies	Electrical	Electro-mechanical	Process Controls	Automation	Power Electronic Controls	Medical Imaging	Avionics	A/V & Security Systems
Equipment	Switch Gear, Interlocks, Motors, Pumps, Fans, Furnaces, Presses, Mixers, Refrigeration	Actuators, Linear Motors, Pressure-Level-Flow-Position Sensors, Packaging Equipment	Transducers / Sensors, Loop Controllers, Calibrated Gauges	PLC's, Sensors, Transducers < Motion Controllers, Rotary Encoders, Scanners, Readers, Printers	Inverter based; Variable Speed Drive Controllers, Uninterruptable Power Supplies, Solor Inverters, Backup Power Systems	XRay, MRI, Ultrasound Imaging equipment	Flight line Navigation Systems, Communication systems, Radars, On board aircraft control systems	Retail security devices, Surveillance and monitoring equipment, RFID
120 Series: Electrical and Electromechanical Troubleshooting								
123	•							
124		•						
Industrial Network Bus Health Troubleshooting								
125		•	•					
190 Series II: Industrial Electronics, Automation, Process Control Testing and Electronic Field Service								
190-062		•						
190-102			•					
190-202				•				
190-502					•	•	•	•
190-104			•					
190-204				•	•	•	•	•

Comprehensive selection guides will be available on the web and in the datasheet

Selection guide

Features	120 Series			190 Series II ScopeMeter					
	123	124	125	190-062	190-102	190-202	190-502	190-104	190-204
Bandwidth (MHz)	20	40	40	60	100	200	500	100	200
Scope Inputs	2	2	2	2	2	2	2	4	4
Dedicated DMM	2	2	2	1	1	1	1	-	-
Dual Input Trendplot™	•	•	•	•	•	•	•	-	-
Four Input Trendplot™	-	-	-	-	-	-	-	•	•
ScopeRecord Mode	-	-	-	•	•	•	•	•	•
Automatic Capture & Replay Mode	-	-	-	•	•	•	•	•	•
Cursors	-	•	•	•	•	•	•	•	•
Zoom	-	-	-	•	•	•	•	•	•
Bus Health Test Mode	-	-	•	-	-	-	-	-	-
Advanced Power Measurements			•	•	•	•	•	•	•
EN61010-1 CAT III Safety Rating	600 V	600 V	600 V	1000 V	1000 V	1000 V	1000 V	1000 V	1000 V
EN61010-1 CAT IV Safety Rating	-	-	-	600 V	600 V	600 V	600 V	600 V	600 V
Battery	7 hr NiMH	7 hr NiMH	7 hr NiMH	4 hr Li-Ion (8 hr Opt)	4 hr Li-Ion (8 hr Opt)	7 hr Li-Ion	7 hr Li-Ion	7 hr Li-Ion	7 hr Li-Ion
Optical RS-232	•	•	•	-	-	-	-	-	-
Isolated USB	Opt	Opt	Opt	•	•	•	•	•	•
Isolated USB Memory	-	-	-	•	•	•	•	•	•

Ordering information

Models

Fluke 190-502	Color ScopeMeter, 500 MHz, 2 channels, DMM
Fluke 190-502/S	Color ScopeMeter, 500 MHz, 2 channels, DMM with SCC-290 kit included
Fluke 190-204	Color ScopeMeter, 200 MHz, 4 channels
Fluke 190-204/S	Color ScopeMeter, 200 MHz, 4 channels, with SCC-290 kit included
Fluke 190-104	Color ScopeMeter, 100 MHz, 4 channels
Fluke 190-104/S	Color ScopeMeter, 100 MHz, 4 channels, with SCC-290 kit included
Fluke 190-202	Color ScopeMeter, 200 MHz, 2 channels plus DMM/Ext.input
Fluke 190-202/S	Color ScopeMeter, 200 MHz, 2 channels plus DMM/Ext.input, with SCC-290 kit included
Fluke 190-102	Color ScopeMeter, 100 MHz, 2 channels plus DMM/Ext.input
Fluke 190-102/S	Color ScopeMeter, 100 MHz, 2 channels plus DMM/Ext.input, with SCC-290 kit included
Fluke 190-062	Color ScopeMeter, 60 MHz, 2 channels plus DMM/Ext.input
Fluke 190-062/S	Color ScopeMeter, 60 MHz, 2 channels plus DMM/Ext.input, with SCC-290 kit included
Fluke 125	Industrial ScopeMeter (40 MHz)
Fluke 125/S	Industrial ScopeMeter (40 MHz) + SCC120 kit
Fluke 124	Industrial ScopeMeter (40 MHz)
Fluke 124/S	Industrial ScopeMeter (40 MHz) + SCC120 kit
Fluke 123	Industrial ScopeMeter (20 MHz)
Fluke 123/S	Industrial ScopeMeter (20 MHz) + SCC120 kit

Optional accessories

Accessories for ScopeMeter 190 Series II

C290	Hard shell protective carrying case for 190 Series II
HH290	Hanging Hook for 190 Series II instruments
SCC290	FlukeView Software (full version) and C290 Carrying Case kit
VPS 510-R	Electronic Voltage Probe Set, 10:1, 500 MHz one set Red
VPS 510-G	Electronic Voltage Probe Set, 10:1, 500 MHz one set Grey
VPS 510-B	Electronic Voltage Probe Set, 10:1, 500 MHz one set Blue
VPS 510-V	Electronic Voltage Probe Set, 10:1, 500 MHz one set Green
S500	Replacement Set of Probe Accessories for Fluke VPS500 series probes
VPS410-R	Industrial Voltage Probe set, 10:1, one set red
VPS410-G	Industrial Voltage Probe set, 10:1, one set grey
VPS410-B	Industrial Voltage Probe set, 10:1, one set blue
VPS410-V	Industrial Voltage Probe set, 10:1, one set green
VPS420-R	High voltage probe set 150 MHz, 100:1, CAT III 2000 V (1000 V to earth)
BC190	Mains adapter/battery charger
EBC290	External battery charger for BP290 and BP291
TL175	TwistGuard™ safety designed Test Leads set (1 red, 1 black)
BP290	Li-Ion battery pack, 2400 mAh
BP291	Li-Ion battery pack, 4800 mAh
SW90W	FlukeView® ScopeMeter Software for Windows®

Accessories for ScopeMeter 120 Series

SCC120	FlukeView® Software + Cable + Case
PM9080	Optically Isolated RS-232 adapter/cable
OC4USB	Optically Isolated USB interface cable
DP120	Differential Voltage Probe
BHT190	Bus Health Test break-out adapter for DB-9, RJ-45 and M12 connection systems
ITP120	Optically Isolated External Trigger Input
SW90W	FlukeView® ScopeMeter Software for Windows®
C120	Hard Shell Carrying Case



Fluke 190 Series II instruments include a set of voltage probes (2 or 4 dependant on model), hanging strap, USB cable with mini-B connector, double capacity Li-Ion battery BP291, battery charger/power adapter BC190, a FlukeView demo package and user manuals on CD.

The 2-channel models come with two probes plus a set of TL175 test leads and a single capacity battery BP290.

SCC kit includes: Hard-shell carrying case, USB interface cable, and non demo version of FlukeView® for Windows® software.

Fluke. *The Most Trusted Tools in the World.*

Fluke Corporation

PO Box 9090, Everett, WA 98206 U.S.A.

Fluke Europe B.V.

PO Box 1186, 5602 BD Eindhoven, The Netherlands

For more information call:

In the U.S.A. (800) 443-5853 or
 Fax (425) 446-5116
 In Europe/M-East/Africa +31 (0) 40 2675 200 or
 Fax +31 (0) 40 2675 222
 In Canada (800)-36-FLUKE or
 Fax (905) 890-6866
 From other countries +1 (425) 446-5500 or
 Fax +1 (425) 446-5116
 Web access: <http://www.fluke.com>

©2010-2012 Fluke Corporation.
 Specifications subject to change without notice.
 Printed in U.S.A. 9/2012 3801594C_EN
 Pub_ID: 11782-eng

Modification of this document is not permitted without written permission from Fluke Corporation.

X-ON Electronics

Largest Supplier of Electrical and Electronic Components

Click to view similar products for [Handheld Oscilloscopes](#) category:

Click to view products by [Fluke](#) manufacturer:

Other Similar products are found below :

[410-320](#) [2516](#) [FLUKE-123B/NA](#) [2512](#) [2511](#) [2515](#) [OC4USB](#) [MS420](#) [109060021](#) [109060022](#)