



# 多层片式陶瓷电容器 产品目录书

---

安徽省富捷电子科技有限公司  
ANHUI FOJAN TECHNOLOGY CO., LTD

# 目 录 CONTENTS

<b>电容器 与介质分类</b>	-----	01
<b>产品 结构</b>	-----	02
<b>产品规格型号 命名规则</b>	-----	03
<b>产品容量 范围</b>	-----	04-16
<b>产品 尺寸</b>	-----	17
<b>技术要求 和测试条件</b>	-----	18-27
<b>产品 包装</b>	-----	28-32
<b>MLCC 使用注意事项</b>	-----	33-38

## 电容器及介质分类

### Types of Capacitor and Dielectric Material

**COG:** 此类介质材料的电容器为 I 类电容器，包括常规、中高压 COG 产品。此类产品电性能稳定，几乎不随温度、电压和时间的变化而变化。适用于低损耗，稳定性要求高的电路中，如滤波器、谐振器和计时电路中。

**COG:** The capacitor of this kind dielectric material is considered as Class I capacitor, including general capacitor and high frequency COG capacitor. The electrical properties of COG capacitor are the most stable one and have little change with temperature, voltage and time. They are suited for applications where low-losses and high-stability are required, such as filters, oscillators, and timing circuits.

**X7R、X5R、X6S、X7T:** 此类介质材料的电容器为 II 类电容器，具有较高的介电常数，容量比 I 类电容器高，具有较稳定的温度特性，适用于容量范围广，稳定性要求不高的电路中，如隔直、耦合、旁路、鉴频等电路中。

**X7R、X5R、X6S、X7T:** material is a kind of material has high dielectric constant. The capacitor made of this kind material is considered as Class II capacitor whose capacitance is higher than that of class I. These capacitors are classified as having a semi-stable temperature characteristic and used over a wide temperature range, such in these kinds of circuits, DC-blocking, decoupling, bypassing, frequency discriminating etc.

**Y5V:** 此类介质材料的电容器为 II 类电容器，是所有电容器中介电常数最大的电容器，但其容量稳定性较差，对温度、电压等条件较敏感，适用于要求大容量，温度变化不大的电路中。

**Y5V:** The capacitor made of this kind of material is the highest dielectric constant of all ceramic capacitors. They are used over a moderate temperature range in application where high capacitance is required because of its unstable temperature coefficient, but where moderate losses and capacitance changes can be tolerated. Its capacitance and dissipation factors are sensible to measuring conditions, such as temperature and voltage, etc

产品结构  
Product Frame

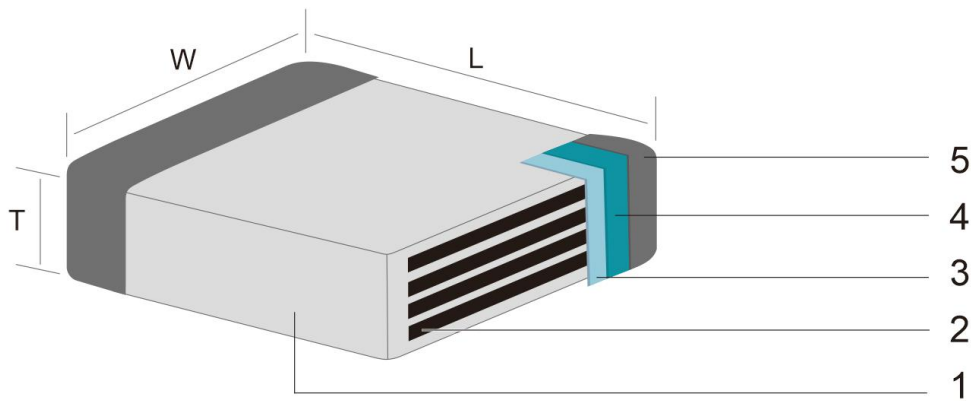

图示说明

- 1 ----- 陶瓷介质
- 2 ----- 内电极
- 3 ----- 外电极
- 4 ----- 镍层
- 5 ----- 锡层



## 产品规格型号命名规则

### General Product Parts Numbering System

例 [example] FCC0805F105M500DT

<b>F</b> 公司名	FOJAN
<b>CC</b> 产品别	陶瓷电容器代号 Code of Ceramic Capacitor
<b>0805</b> 尺寸	规格 Chip Size Type=L×W 0201=0.60×0.30mm 0402=1.00×0.50mm 0603=1.60×0.80mm 0805=2.00×1.25mm 1206=3.20×1.60mm 1210=3.20×2.50mm
<b>F</b> 温度特性	温度特性 Dielectrics COG=N, X7R=B, X5R=X, Y5V=F, X7T=T, X6S=S
<b>105</b> 电容值	电容值 Capacitance 105=10×10 <sup>5</sup> =1000,000pF 5 表示 10 <sup>5</sup> Two significant digits followed by no. of zero
<b>M</b> 公差	容量容差 Capacitance Tolerance A=±0.05pF B=±0.1pF C=±0.25pF D=±0.5pF F=±1.0% G=±2.0% J=±5.0% K=±10% M=±20% Z=-20/+80%
<b>500</b> 额定电压	额定电压 Rated Voltage 6R3=6.3V <sub>DC</sub> 100=10V <sub>DC</sub> 160=16V <sub>DC</sub> 250=25V <sub>DC</sub> 500=50V <sub>DC</sub> 101=100V <sub>DC</sub> 201=200V <sub>DC</sub> 251=250V <sub>DC</sub> 501=500V <sub>DC</sub> 102=1000V <sub>DC</sub> 202=2000V <sub>DC</sub>
<b>D</b> 厚度	厚度 Thickness A:0.5±0.10mm B:0.60±0.10mm C:0.80±0.10mm D:0.85±0.10mm E:1.00±0.10mm F:1.25±0.20mm H:1.6±0.20mm G:2.0±0.20mm M:2.5±0.30mm Z:0.3±0.03mm
<b>T</b> 包装	包装 Packing B:袋散装 B: bulk packaging in a bag T:编带 T:tape carrier packa
<b>S</b> 特殊码	特殊码 Specific S:防断裂

#### 产品的介质特性组别

材质	工作温度范围	温度系数或温度特性
C0G (N)	-55°C~+125°C	0±30ppm/°C
X7R (B)	-55°C~+125°C	±15%
X5R (X)	-55°C~+85°C	±15%
X7T (T)	-55°C~+125°C	+22/-33%
Y5V (F)	-30°C~+85°C	+22/-82%
X6S (S)	-55°C~+105°C	±22%

## 产品容量范围 Product Capacitance Range

### ▪ 0201[0603]尺寸

尺寸		0201[0603]											
系列 型号	V <sub>DC</sub>	X5R (X)				X6S (S)				X7T (T)			
		CP		25	16	10	6.3	25	16	10	6.3	16	10
	103	Z				Z				Z			
	223	Z	Z			Z	Z			Z	Z		
	473		Z				Z				Z		
	683		Z	Z			Z	Z			Z	Z	
	104		Z	Z			Z	Z			Z	Z	
	224				Z				Z				Z
说明													
<p>容量容差: X5R/X6S/X7T; K(±10%); M(±20%) 厚度: Z: 0.30±0.03mm 以上容量仅供参考, 具体容量取决于使用要求。</p> <p>Tolerance: X5R/X6S/X7T: K(±10%); M(±20%) Thickness: Z: 0.30±0.03mm ; Above capacitance for reference only, actual cap. Range depends on the standard products.</p>													

▪ 0402[1005]尺寸

尺寸	0402[1005]																												
	系列 型号	COG (N)		X7R (B)				X6S (S)				X5R (X)				X7T (T)				Y5V (F)									
CP V <sub>DC</sub>	5 0	2 5	5 0	2 5	1 6	1 0	6 · 3	5 0	2 5	1 6	1 0	6 · 3	5 0	2 5	1 6	1 0	6 · 3	5 0	2 5	1 6	1 0	6 · 3	5 0	2 5	1 6	1 0	6 · 3		
0R5	A	A																											
1R0	A	A																											
2R0	A	A																											
3R0	A	A																											
4R0	A	A																											
5R0	A	A																											
6R0	A	A																											
7R0	A	A																											
8R0	A	A																											
9R0	A	A																											
100	A	A																											
120	A	A																											
150	A	A																											
180	A	A																											
200	A	A																											
220	A	A																											
270	A	A																											
300	A	A																											
330	A	A																											
390	A	A																											
470	A	A																											
560	A	A																											
680	A	A																											
820	A	A																											
101	A	A	A	A	A	A	A	A	A	A	A	A	A	A	A	A	A	A	A	A	A	A	A	A	A	A	A	A	A
121	A	A	A	A	A	A	A	A	A	A	A	A	A	A	A	A	A	A	A	A	A	A	A	A	A	A	A	A	A
151	A	A	A	A	A	A	A	A	A	A	A	A	A	A	A	A	A	A	A	A	A	A	A	A	A	A	A	A	A
181	A	A	A	A	A	A	A	A	A	A	A	A	A	A	A	A	A	A	A	A	A	A	A	A	A	A	A	A	A
201	A	A	A	A	A	A	A	A	A	A	A	A	A	A	A	A	A	A	A	A	A	A	A	A	A	A	A	A	A
221	A	A	A	A	A	A	A	A	A	A	A	A	A	A	A	A	A	A	A	A	A	A	A	A	A	A	A	A	A
271	A	A	A	A	A	A	A	A	A	A	A	A	A	A	A	A	A	A	A	A	A	A	A	A	A	A	A	A	A
331	A	A	A	A	A	A	A	A	A	A	A	A	A	A	A	A	A	A	A	A	A	A	A	A	A	A	A	A	A
391	A	A	A	A	A	A	A	A	A	A	A	A	A	A	A	A	A	A	A	A	A	A	A	A	A	A	A	A	A
471	A	A	A	A	A	A	A	A	A	A	A	A	A	A	A	A	A	A	A	A	A	A	A	A	A	A	A	A	A
561	A	A	A	A	A	A	A	A	A	A	A	A	A	A	A	A	A	A	A	A	A	A	A	A	A	A	A	A	A
681	A	A	A	A	A	A	A	A	A	A	A	A	A	A	A	A	A	A	A	A	A	A	A	A	A	A	A	A	A
821	A	A	A	A	A	A	A	A	A	A	A	A	A	A	A	A	A	A	A	A	A	A	A	A	A	A	A	A	A
102	A	A	A	A	A	A	A	A	A	A	A	A	A	A	A	A	A	A	A	A	A	A	A	A	A	A	A	A	A
152			A	A	A	A	A	A	A	A	A	A	A	A	A	A	A	A	A	A	A	A	A	A	A	A	A	A	A
182			A	A	A	A	A	A	A	A	A	A	A	A	A	A	A	A	A	A	A	A	A	A	A	A	A	A	A
222			A	A	A	A	A	A	A	A	A	A	A	A	A	A	A	A	A	A	A	A	A	A	A	A	A	A	A
272			A	A	A	A	A	A	A	A	A	A	A	A	A	A	A	A	A	A	A	A	A	A	A	A	A	A	A
332			A	A	A	A	A	A	A	A	A	A	A	A	A	A	A	A	A	A	A	A	A	A	A	A	A	A	A
472			A	A	A	A	A	A	A	A	A	A	A	A	A	A	A	A	A	A	A	A	A	A	A	A	A	A	A



562			A	A	A	A	A	A	A	A	A	A	A	A	A	A	A	A	A	A	A	A	A	A	A	A
103			A	A	A	A	A	A	A	A	A	A	A	A	A	A	A	A	A	A	A	A	A	A	A	A
153			A	A	A	A	A	A	A	A	A	A	A	A	A	A	A	A	A	A	A	A	A	A	A	A
183				A	A	A	A		A	A	A	A		A	A	A	A		A	A	A	A	A	A	A	A
223				A	A	A	A		A	A	A	A		A	A	A	A		A	A	A	A	A	A	A	A
273				A	A	A	A		A	A	A	A		A	A	A	A		A	A	A	A	A	A	A	A
333				A	A	A	A		A	A	A	A		A	A	A	A		A	A	A	A	A	A	A	A
393				A	A	A	A		A	A	A	A		A	A	A	A		A	A	A	A	A	A	A	A
473				A	A	A	A		A	A	A	A		A	A	A	A		A	A	A	A	A	A	A	A
563				A	A	A	A		A	A	A	A		A	A	A	A		A	A	A	A		A	A	A
683				A	A	A	A		A	A	A	A		A	A	A	A		A	A	A	A		A	A	A
104				A	A	A	A			A	A	A			A	A	A			A	A	A			A	A
154					A	A	A			A	A	A			A	A	A			A	A	A			A	A
184						A	A				A	A				A	A				A	A			A	A
224						A	A				A	A				A	A				A	A			A	A
274							A					A					A					A				A
334							A					A					A						A			A
474							A					A					A							A		A
684							A					A					A								A	
105							A					A					A									A

### 说明

**容量容差:**

COG(0.5pF~4.9pF): B/C; COG(5.0pF~9.9pF): D; COG(≥10pF): F(±1%), G(±2%), J(±5%),  
 X7R/X5R/X6S/X7T: J(±5.0%); K(±10%); M(±20%) ;  
 Y5V: M(±20%); Z(-20,+80%)

厚度: A: 0.50±0.10mm;

以上容量仅供参考，具体容量取决于使用要求。

**Tolerance:**

COG(0.5pF~4.9pF): COG(5.0pF~9.9pF): D; COG(≥10pF): F(±1%), G(±2%), J(±5%)  
 X7R/X5R/X6S/X7T: J(±5.0%); K(±10%); M(±20%)  
 Y5V: M(±20%); Z(-20,+80%)

Thickness: A: 0.50±0.10mm ;

Above capacitance for reference only, actual cap. Range depends on the standard products.





▪ 0603[1608]尺寸

尺寸	0603[1608]																													
系列 型号	COG (N)					X7R (B)					X6S (S)					X5R (X)					X7T (T)					Y5V (F)				
CP V <sub>DC</sub>	2 5 0 0	2 0 0 0	1 0 0 0	5 0 0 0	2 5 0 0	2 5 0 0	1 0 0 0	5 0 0 0	2 5 6 0	1 1 0 0	6 3	5 0	2 5	1 6	1 0	6 3	5 0	2 5	1 6	1 0	6 3	2 5	1 6	1 0	6 3	4	5 0	2 5	1 6	1 0
0R5	C	C	C	C	C																									
1R0	C	C	C	C	C																									
2R0	C	C	C	C	C																									
3R0	C	C	C	C	C																									
4R0	C	C	C	C	C																									
5R0	C	C	C	C	C																									
6R0	C	C	C	C	C																									
7R0	C	C	C	C	C																									
8R0	C	C	C	C	C																									
9R0	C	C	C	C	C																									
100	C	C	C	C	C																									
120	C	C	C	C	C																									
150	C	C	C	C	C																									
180	C	C	C	C	C																									
200	C	C	C	C	C																									
220	C	C	C	C	C																									
270	C	C	C	C	C																									
300	C	C	C	C	C																									
330	C	C	C	C	C																									
390	C	C	C	C	C																									
470	C	C	C	C	C																									
560	C	C	C	C	C																									
680	C	C	C	C	C																									
820	C	C	C	C	C																									
101	C	C	C	C	C	C	C	C																						
121	C	C	C	C	C	C	C	C																						
151	C	C	C	C	C	C	C	C																						
181	C	C	C	C	C	C	C	C																						
201	C	C	C	C	C	C	C	C																						
221	C	C	C	C	C	C	C	C	C	C	C	C	C	C	C	C	C	C	C	C	C	C	C	C	C	C	C	C	C	C
271	C	C	C	C	C	C	C	C	C	C	C	C	C	C	C	C	C	C	C	C	C	C	C	C	C	C	C	C	C	C
331	C	C	C	C	C	C	C	C	C	C	C	C	C	C	C	C	C	C	C	C	C	C	C	C	C	C	C	C	C	C
391	C	C	C	C	C	C	C	C	C	C	C	C	C	C	C	C	C	C	C	C	C	C	C	C	C	C	C	C	C	C
471	C	C	C	C	C	C	C	C	C	C	C	C	C	C	C	C	C	C	C	C	C	C	C	C	C	C	C	C	C	C
561			C	C	C	C	C	C	C	C	C	C	C	C	C	C	C	C	C	C	C	C	C	C	C	C	C	C	C	C
681			C	C	C	C	C	C	C	C	C	C	C	C	C	C	C	C	C	C	C	C	C	C	C	C	C	C	C	C
821			C	C	C	C	C	C	C	C	C	C	C	C	C	C	C	C	C	C	C	C	C	C	C	C	C	C	C	C
102				C	C	C	C	C	C	C	C	C	C	C	C	C	C	C	C	C	C	C	C	C	C	C	C	C	C	C
152				C	C	C	C	C	C	C	C	C	C	C	C	C	C	C	C	C	C	C	C	C	C	C	C	C	C	C
182				C	C	C	C	C	C	C	C	C	C	C	C	C	C	C	C	C	C	C	C	C	C	C	C	C	C	C
222				C	C	C	C	C	C	C	C	C	C	C	C	C	C	C	C	C	C	C	C	C	C	C	C	C	C	C
272					C	C	C	C	C	C	C	C	C	C	C	C	C	C	C	C	C	C	C	C	C	C	C	C	C	C
332						C	C	C	C	C	C	C	C	C	C	C	C	C	C	C	C	C	C	C	C	C	C	C	C	C
472						C	C	C	C	C	C	C	C	C	C	C	C	C	C	C	C	C	C	C	C	C	C	C	C	C
562						C	C	C	C	C	C	C	C	C	C	C	C	C	C	C	C	C	C	C	C	C	C	C	C	C
682						C	C	C	C	C	C	C	C	C	C	C	C	C	C	C	C	C	C	C	C	C	C	C	C	C
103							C	C	C	C	C	C	C	C	C	C	C	C	C	C	C	C	C	C	C	C	C	C	C	C
153							C	C	C	C	C	C	C	C	C	C	C	C	C	C	C	C	C	C	C	C	C	C	C	C
183							C	C	C	C	C	C	C	C	C	C	C	C	C	C	C	C	C	C	C	C	C	C	C	C
223							C	C	C	C	C	C	C	C	C	C	C	C	C	C	C	C	C	C	C	C	C	C	C	C
273								C	C	C	C	C	C	C	C	C	C	C	C	C	C	C	C	C	C	C	C	C	C	C





▪ 0805[2012]尺寸

尺寸	0805[2012]																															
系列 型号	COG (N)					X7R (B)					X6S (S)					X5R (X)					X7T (T)				Y5V (F)							
CP V <sub>DC</sub>	2 5 0	1 0 0	5 0 0	2 5 6	1 6	2 5 0	1 0 0	5 0 0	2 5 6	1 6 0	1 0 3	6 0 3	5 5 0	2 6 0	1 6 0	1 0 3	6 0 3	5 5 0	2 6 0	1 6 0	1 0 3	6 4 3	2 5 6	1 6 0	1 6 0	4 3	5 0 5	2 5 6	1 6 0	1 0 3	6 3	
0R5	B	B	B	B	B																											
1R0	B	B	B	B	B																											
2R0	B	B	B	B	B																											
3R0	B	B	B	B	B																											
4R0	B	B	B	B	B																											
5R0	B	B	B	B	B																											
6R0	B	B	B	B	B																											
7R0	B	B	B	B	B																											
8R0	B	B	B	B	B																											
9R0	B	B	B	B	B																											
100	B	B	B	B	B																											
120	B	B	B	B	B																											
150	B	B	B	B	B																											
180	B	B	B	B	B																											
200	B	B	B	B	B																											
220	B	B	B	B	B																											
270	B	B	B	B	B																											
300	B	B	B	B	B																											
330	B	B	B	B	B																											
390	B	B	B	B	B																											
470	B	B	B	B	B																											
560	B	B	B	B	B																											
680	B	B	B	B	B																											
820	B	B	B	B	B																											
101	B	B	B	B	B	B	B																									
121	B	B	B	B	B	B	B																									
151	B	B	B	B	B	B	B																									
181	B	B	B	B	B	B	B																									
201	B	B	B	B	B	B	B																									
221	B	B	B	B	B	D	D	D	D	D	D	D	D	D	D	D	D	D	D	D	D	D	D	D	D	D	D	D	D	D	D	
271	B	B	B	B	B	D	D	D	D	D	D	D	D	D	D	D	D	D	D	D	D	D	D	D	D	D	D	D	D	D	D	
331	B	B	B	B	B	D	D	B	B	B	B	B	B	B	B	B	B	B	B	B	B	B	B	B	B	B	B	B	B	B	B	B
391	B	B	B	B	B	D	D	B	B	B	B	B	B	B	B	B	B	B	B	B	B	B	B	B	B	B	B	B	B	B	B	B
471	B	B	B	B	B	D	D	B	B	B	B	B	B	B	B	B	B	B	B	B	B	B	B	B	B	B	B	B	B	B	B	B
561	B	B	B	B	B	D	D	B	B	B	B	B	B	B	B	B	B	B	B	B	B	B	B	B	B	B	B	B	B	B	B	B
681	B	B	B	B	B	D	D	B	B	B	B	B	B	B	B	B	B	B	B	B	B	B	B	B	B	B	B	B	B	B	B	B
821	B	B	B	B	B	D	D	B	B	B	B	B	B	B	B	B	B	B	B	B	B	B	B	B	B	B	B	B	B	B	B	B
102	B	B	B	B	B	D	D	B	B	B	B	B	B	B	B	B	B	B	B	B	B	B	B	B	B	B	B	B	B	B	B	B





▪ 1206[3216]尺寸

尺寸	1206[3216]																																																					
系列 型号	COG (N)								X7R (B)								X6S (S)				X5R (X)				X7T (T)				Y5V (F)																									
	2	1	6	5	2	1	5	2	1	2	1	6	5	2	1	5	2	1	1	6	5	2	1	1	6	5	2	1	1	6	2	1	1	6	4	5	2	1	1	6														
CP V <sub>DC</sub>	0	0	0	3	0	5	0	0	5	6	0	0	3	0	5	0	0	5	6	0	.	0	5	6	0	.	0	5	6	0	.	3	0	5	6	0	.	3	0	5	6	0	.	3	0	5	6	0	.	3	0	5	6	0
0R5	D	D	D	D	D	D	D	D	D																																													
1R0	D	D	D	D	D	D	D	D	D																																													
2R0	D	D	D	D	D	D	D	D	D																																													
3R0	D	D	D	D	D	D	D	D	D																																													
4R0	D	D	D	D	D	D	D	D	D																																													
5R0	D	D	D	D	D	D	D	D	D																																													
6R0	D	D	D	D	D	D	D	D	D																																													
7R0	D	D	D	D	D	D	D	D	D																																													
8R0	D	D	D	D	D	D	D	D	D																																													
9R0	D	D	D	D	D	D	D	D	D																																													
100	D	D	D	D	D	D	D	D	D																																													
120	D	D	D	D	D	D	D	D	D																																													
150	D	D	D	D	D	D	D	D	D																																													
180	D	D	D	D	D	D	D	D	D																																													
200	D	D	D	D	D	D	D	D	D																																													
220	D / E / F	D	D	D	D	D	D	D	D																																													
270	D / E / F	D	D	D	D	D	D	D	D																																													
300	D / E / F	D	D	D	D	D	D	D	D																																													
330	D / E / F	D	D	D	D	D	D	D	D																																													
390	D / E / F	D	D	D	D	D	D	D	D																																													
470	D / E / F	D	D	D	D	D	D	D	D																																													
560	D / E	D	D	D	D	D	D	D	D																																													









▪ 1210[3225]尺寸

尺寸	1210[3225]																													
	COG (N)					X7R (B)					X6S (S)				X5R (X)			X7T (T)			Y5V (F)									
系列 型号	20000	10000	50000	20000	15000	20000	10000	63000	50000	20000	15000	20000	10000	10000	63000	50000	20000	10000	10000	63000	20000	10000	10000	63000	50000	20000	10000	10000	63000	
100	D																													
120	D																													
150	D																													
180	D																													
200	D																													
220	D																													
270	D																													
300	D																													
330	D																													
390	D																													
470	D																													
560	D																													
680	D																													
820	D																													
101	D	D	D	D		D																								
121	F	D	D	D		D																								
151	F	D	D	D		D																								
181	F	D	D	D		D																								
201	F	D	D	D		D																								
221	F	D	D	D		D	F	F	F	F	F	F	F	F																
271		D	D	D		D	F	F	F	F	F	F	F	F																
331		D	D	D		D	F	F	F	F	F	F	F	F																
391		D	D	D		D	F	F	F	F	F	F	F	F																
471		D	D	D		D	F	F	F	F	F	F	F	F																
561		F	D	D		D	F	F	F	F	F	F	F	F																
681		F	D	D		D	F	F	F	F	F	F	F	F																
821		F	D	D		D	F	F	F	F	F	F	F	F																
102		F	D	D		D	F	F	F	F	F	F	F	F																
152			D	D		D	F	F	F	F	F	F	F	F																
182			D	D		D	F	F	F	F	F	F	F	F																
222			D	D		D	F	F	F	F	F	F	F	F																
272			F	D		D		F	F	F	F	F	F	F																
332				D		D		F	F	F	F	F	F	F																
472				D				F	F	F	F	F	F	F																
562								F	F	F	F	F	F	F																
682								F	F	F	F	F	F	F																
103								F	F	F	F	F	F	F																
153								F	F	F	F	F	F	F																
223									H	H	F	F																		
333									H	H	F	F																		
473									G	G	F	F																		
563											F	F																		
683											F	F																		
104											F	F																		
154											H	H																		

224											G	H																																			
334												G																																			
394												G																																			
474											G	G	G	G	G	G	G	G	G	G	G	G	G	G	G	G	G	G	G	G	G	G	G	G	G	G	G	G	G	G	G	G					
684											H	H	H	H	H	H	H	H	H	H	H	H	H	H	H	H	H	H	H	H	H	H	H	H	H	H	H	H	H	H	H	H					
105											H	H	H	H	H	H	H	H	H	H	H	H	H	H	H	H	H	H	H	H	H	H	H	H	H	H	H	H	H	H	H	H					
225											H	H	H	H	H	H	H	H	H	H	H	H	H	H	H	H	H	H	H	H	H	H	H	H	H	H	H	H	H	H	H	H					
475											H	/	H	H	H		H	/	H	H	H		H	/	H	H	H		H	/	H	H	H		H	/	H	H	H		H	/	H	H	H		
106											M	G	M	M		M	G	M	M		M	G	M	M		M	G	M	M		M	G	M	M		M	G	M	M		M	G	M	M			
226												M	M	M			M	M	M			M	M	M			M	M	M			M	M	M			M	M	M			M	M	M			
476													M	M				M	M				M	M				M	M				M	M					M	M				M	M		
107													M					M											M										M						M		

## 说明

## 容量容差:

COG( $\geq 10\text{pF}$ ): F( $\pm 1\%$ ), G( $\pm 2\%$ ), J( $\pm 5\%$ ), K( $\pm 10\%$ );X7R/X5R/X6S/X7T: J( $\pm 5.0\%$ ); K( $\pm 10\%$ ); M( $\pm 20\%$ );Y5V: M( $\pm 20\%$ ); Z(-20,+80%)厚度: D:  $0.85\pm 0.1\text{mm}$ 、F:  $1.25\pm 0.2\text{mm}$ 、H:  $1.60\pm 0.2\text{mm}$ 、G:  $2.00\pm 0.2\text{mm}$ 、M:  $2.50\pm 0.3\text{mm}$ ;

以上容量仅供参考, 具体容量取决于使用要求。

## Tolerance:

COG( $\geq 10\text{pF}$ ): F( $\pm 1\%$ ), G( $\pm 2\%$ ), J( $\pm 5\%$ );X7R/X5R/X6S/X7T: J( $\pm 5.0\%$ ); K( $\pm 10\%$ ); M( $\pm 20\%$ );Y5V: M( $\pm 20\%$ ); Z(-20,+80%)Thickness: D:  $0.85\pm 0.1\text{mm}$ 、F:  $1.25\pm 0.2\text{mm}$ 、H:  $1.60\pm 0.2\text{mm}$ 、G:  $2.00\pm 0.2\text{mm}$ 、M:  $2.50\pm 0.3\text{mm}$ ;

Above capacitance for reference only, actual cap. Range depends on the standard products.

## 产品尺寸 Dimensions

规格: 0201、0402、0603、0805、1206、1210。  
Chip Size: 0201,0402,0603,0805, 1206 and 1210

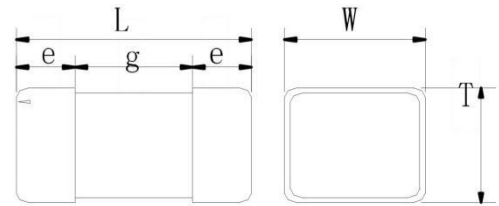

规格 Type	L (mm)	W (mm)	e (mm)	g min (mm)	T (mm)				
0201	0.60±0.03	0.30±0.03	0.1~0.2	0.2	0.30±0.03				
0402	1.00±0.10	0.50±0.10	0.15~0.3	0.4	0.50±0.10	—	—	—	—
0603	1.60±0.10	0.80±0.10	0.2~0.6	0.5	0.80±0.10	—	—	—	—
0603*1	1.60±0.20*1	0.80±0.20*1	0.2~0.6	0.5	0.80±0.20*1	—	—	—	—
0805	2.00±0.10	1.25±0.10	0.2~0.7	0.7	0.60±0.10	0.85±0.10	1.25±0.20	—	—
0805*1	2.00±0.20*1	1.25±0.20*1	0.2~0.7	0.7	0.60±0.10	0.85±0.10	1.25±0.20	—	—
1206	3.20±0.20	1.60±0.20	0.3~0.8	1.6	0.85±0.10	1.00±0.10	1.25±0.20	1.60±0.20	—
1206*1	3.20±0.30*1	1.60±0.30*1	0.3~0.8	1.6	0.85±0.10	1.00±0.10	1.25±0.20	1.60±0.30*1	—
1210	3.20±0.30	2.5±0.20	0.3~0.8	1.6	0.85±0.10	1.25±0.20	1.60±0.20	2.00±0.20	2.50±0.30
1210*1	3.20±0.40*1	2.5±0.30*1	0.3~0.8	1.6	0.85±0.10	1.25±0.20	1.60±0.20	2.00±0.20	2.50±0.30

\*1 标识该规格型号标识为 1uF 及以上规格产品尺寸。

## 技术要求和测试条件

### Specification and Test Condition

#### ■ 外观 Appearance

类型 Dielectrics	技术要求 Specification	测试条件 Testing Condition
COG/X7R/X5R/Y 5V /X7T/X6S	1/10L < L≤1/8L, 1/10W < W≤1/8W, 1/10T < t≤1/8T (L、W、T 任意一项不符合, 均判定不合格) (L、W、T None is acceptable, All judged unqualified)	目视检查 Visual inspection.

#### ■ 尺寸 Dimensions

类型 Dielectrics	技术要求 Specification	测试条件 Testing Condition
COG/X7R/X5R/Y 5V/ X7T/X6S	在要求的范围内 Within the specified dimensions	用千分尺 Using calipers on micrometer

#### ■ 容量 Capacitance

类型 Dielectrics	技术要求 Specification	测试条件 Testing Condition
COG	在要求的容值容差范围内 Within the specified tolerance A:±0.05pF; B:±0.1pF; C:±0.25pF; D:±0.5pF; J: ±5%	1.0±0.2Vrms, 1MHz±10% (C>1000pF, 1.0±0.2Vrms, 1KHz±10% , )
X7R/X5R/X7T /X6S	在要求的容值容差范围内 Within the specified tolerance J: ±5%; K: ±10%; M: ±20%	1.0±0.2Vrms, 1KHz±10% (Cp > 10uF, 0.5±0.1Vrms, 120±24Hz)
Y5V	在要求的容值容差范围内 Within the specified tolerance M: ±20%; Z: -20%, +80%	1.0±0.2Vrms, 1KHz±10% (Cp > 10uF, 0.5±0.1Vrms, 120±24Hz)

备注:

测试温度: 25°C±3°C, 测试湿度: < 70%RH. 针对二类介质规格需去老化处理, 条件: 电容器在 150°C热处理 1 小时, 放置 48h 后进行测量。

■ 损耗 Dissipation Factor

类型 Dielectrics	技术要求 Specification				测试条件 Testing Condition
COG	Cp<30pF, Q≥400+20Cp; Cp≥30pF, Q≥1000				1.0±0.2Vrms, 1MHz±10% ,25 °C (Cp>1000pF, 1.0±0.2Vrms, 1K Hz±10%)
X7R/X5R/X7T /X6S	0201	≤25v	C≤0.22 μF	≤10.0%	1.0±0.2Vrms, 1KHz±10% ( Cp > 10uF,0.5±0.1Vrms, 120±24Hz)
	0402	≤25v	C≤0.47 μF	≤7.0%	
			C > 0.47 μF	≤10.0%	
		> 25v	C≤0.1 μF	≤7.0%	
			C > 0.1 μF	≤10.0%	
	0603	≤25v	C≤0.47 μF	≤7.0%	
			C > 0.47 μF	≤10.0%	
		> 25v	C≤0.1 μF	≤5.0%	
			0.1 μF < C ≤ 0.22 μF	≤7.0%	
	0805	≤25v	C≤1 μF	≤7.0%	
			C > 1 μF	≤10.0%	
		> 25v	C≤0.47 μF	≤7.0%	
			C > 0.47 μF	≤10.0%	
	1206	≤25v	C < 2.2 μF	≤7.0%	
			2.2 μF ≤ C < 47 μF	≤10.0%	
		> 25v	C > 1 μF	≤7.0%	
			1 μF ≤ C < 47 μF	≤10.0%	
	1210	≤25v	C < 2.2 μF	≤7.0%	
2.2 μF ≤ C < 47 μF			≤10.0%		
Y5V	<b>UR</b>	<b>DF</b>	<b>备注</b>		
	UR≥50v	DF≤7.0%			
	UR=25v	DF≤7.0%	683 > 0402≥473,474 > 0603≥104 105 > 0805≥334,475 > 1206≥684 106 > 1210≥105		
		DF≤9.0%	0402≥683, 0603≥474 0805≥105 1206≥475, 1210≥106		
	UR=16v	DF≤9.0%			
		DF≤12.5%	0402≥224, 0603≥225, 0805≥335 1206≥106,1210≥226, 1812≥476		
	UR=10v	DF≤12.5%			
UR=6.3v	DF≤15.0%				
备注: 测试温度: 25°C±3°C, 测试湿度: < 70%RH. 针对二类介质规格需去老化处理, 条件: 电容器在 150°C热处理 1 小时, 放置 48h 后进行测量。					

## ■ 绝缘电阻 Insulation Resistance

类型 Dielectrics	技术要求 Specification	测试条件 Testing Condition
COG/X7R/ X5R/Y5V/X7T/X6S	$U_R \leq 50V$ , 大于 $10 G\Omega$ 或 $100\Omega \cdot F / CR$ (大于其中较小的数值) $U_R \leq 50V$ , More than $10 G\Omega$ or $100\Omega \cdot F / CR$ , whichever is smaller.	$U_R \leq 50V$ $U_{测} = U_R$ ; 充电时间: $60 \pm 5$ 秒 温度: $25^\circ C$ Charge Time: $60 \pm 5$ sec Temperature: $25^\circ C$
COG/X7R/X7T/X6S	$U_R > 50V$ , 大于 $4G\Omega$ 或 $100\Omega \cdot F / CR$ (大于其中较小的数值) $U_R > 50V$ , More than $4 G\Omega$ or $100\Omega \cdot F / CR$ , whichever is smaller.	$U_R \leq 400V$ $U_{测} = U_R$ $U_R > 400V$ $U_{测} = 400V$ ; 充电时间: $60 \pm 5$ 秒 温度: $25^\circ C$ Charge Time: $60 \pm 5$ sec Temperature: $25^\circ C$
备注: 测试温度: $25^\circ C \pm 3^\circ C$ , 测试湿度: $\leq 70\% RH$ .		

## ■ 耐电压 Dielectric Strength

类型 Dielectrics	额定电压范围 Rated voltage range	耐电压性能测试方法 Measuring Method
COG	$U_R \leq 50V$	施加额定电压的 300%, 5 秒, 最大电流不超过 50mA Force 300% Rated voltage for 5 second. Max. current should not exceed 50 mA.
X7R/X5R/Y5V/X7T/ X6S	$U_R \leq 50V$	施加额定电压的 250%, 5 秒, 最大电流不超过 50mA Force 250% Rated voltage for 5 second. Max. current should not exceed 50 mA.
COG/X7R/X7T	$100V \leq U_R < 500V$	施加额定电压的 200%, 5 秒, 最大电流不超过 50mA Force 200% Rated voltage for 5 second. Max. current should not exceed 50 mA.
	$500V \leq U_R < 1000V$	施加额定电压的 150%, 5 秒, 最大电流不超过 50mA Force 150% Rated voltage for 5 second. Max. current should not exceed 50 mA.
	$1000V \leq U_R < 2000V$	施加额定电压的 150%, 5 秒, 最大电流不超过 50mA Force 150% Rated voltage for 5 second. Max. current should not exceed 50 mA.
	$U_R \geq 2000V$	施加额定电压的 120%, 5 秒, 最大电流不超过 30mA Force 120% Rated voltage for 5 second. Max. current should not exceed 30 mA.

■ 静电容量温度特性 Temperature Coefficient of Capacitance

类型 Dielectrics	技术要求 Specification	测试条件 Testing Condition				
COG	容量变化在±30ppm/°C以内 容量漂移在±0.2%或±0.05p F 以内 Temperature coefficient within ±30ppm/°C; Cp drift within ±0.2% or±0.05pF	按系列温度顺序测试电容容量 Measure capacitance under follow table list temperature: 在 140~150°C预处理 1 小时, 放置24h 后进行测量。				
		步骤 STEP	COG, X7R,X7T	X6S	X5R	Y5V
		1	25 ±2	25 ±2	25 ±2	25 ±2
		2	-55±3	-55±3	-55±3	-30±3
		3	25 ±2	25 ±2	25 ±2	25 ±2
X7R/X5R	容量变化在±15%以内 Capacitance change within ±15%	4	125±3	105±3	85±3	85±3
		5	25 ±2	25 ±2	25 ±2	25 ±2
X7T	容量变化在+22%, -33%以内 Capacitance change within +22%, -33%	1) COG 容量漂移的计算方法为: 用步骤 3 测量的电容容量除以在第 1、3 和 5 步骤测量得到的误差的最大值和最小值的差。 温度系数的计算以第 3 步骤测量电容容量为参考。				
X6S	容量变化在±22%以内 Capacitance change within ±22%	The capacitance drift is calculated by dividing the differences between the maximum and minimum measured values in the step 1,3 and 5. The temperature coefficient is determined using the Capacitance measured in step 3 as a reference.				
Y5V	容量变化在+22%, -82%以内 Capacitance change within +22%, -82%	2) X7R、X5R、X7T、X6S 和 Y5V 与 25°C时的电容容量相比较, 电容容量在温度范围内的变化在要求的范围之内。 X7R、X5R、X7T、X6S and Y5V The ranges of capacitance change compared within the above 25°C value over the temperature ranges shall be within the specified ranges.				

■ 附着力 Adhesion

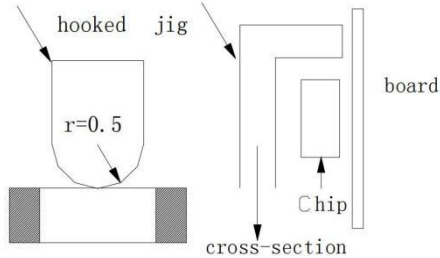
类型 Dielectrics	技术要求 Specification	测试条件 Testing Condition
COG/X7R/X5R/ Y5V/X7T/X6S	端电极无松动, 也无其它不良现象 No removal of the terminations or other defect shall occur.	施加6N 的压力, 并保持 10±1 秒 The pressurizing force shall be 6N (=600g*f) and the duration of application shall be 10±1sec. 

■ 可焊性 Solder ability of Termination

类型 Dielectrics	技术要求 Specification	测试条件 Testing Condition
X7R/X5R/X7T  /X6S	端电极挂锡面积不小于 95%，针孔或粗糙面积小于 5%  95% min. coverage of both terminal electrodes and less than 5% have pin holes or rough spots.	锡炉温度： 245±5℃ 浸入时间： 2±1 秒 两侧端电极完全浸入焊锡炉 Solder temperature: 245±5℃ Dipping time: 2±1 seconds. Completely soak both terminal electrodes in solder

■ 耐焊性 Resistance to leaching

类型 Dielectrics	技术要求 Specification	测试条件 Testing Condition
X7R/X5R/X7T  /X6S	端电极挂锡面积不小于 95%，针孔或粗糙面积小于 5%，外观无开裂  95% min. coverage of both terminal electrodes and less than 5% have pin holes or rough spots.  No remarkable visual damage.	预热： 120℃~ 150℃/60 秒 锡炉温度： 270±5℃ 浸入时间： 10±1 秒 两侧端电极完全浸入焊锡炉 Solder temperature: 270±5℃ preheated: 120℃~ 150℃/60sec Dipping time: 10±1 seconds. Completely soak both terminal electrodes in solder

■ 端电极结合强度 Bending

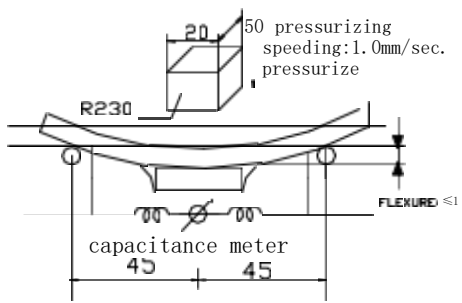
类型 Dielectrics	技术要求 Specification	测试条件 Testing Condition
COG	无可见损伤；容量变化小于等于±5%或±0.5pF（取较大值） No remarkable visual damage Cp change within ±5.0% or ±0.5pF, whichever is larger.	<p>将片状电容器安装在测试夹具上，按图所示方向以 1.0mm/s 的速率施加压力，弯曲 1mm。Solder the capacitor on testing substrate and put it on testing stand. The middle part of substrate shall successively be pressurized by pressuring rod at a rated of about 1.0mm/sec. Until the deflection become means of the 1.0mm.)</p> 
X7R/X5R/X7T  /X6S	无可见损伤； 容量变化小于等于±10% No remarkable visual damage Cp change ≤ ±10%	
Y5V	无可见损伤； 容量变化小于等于 ±30% No remarkable visual damage Cp change ≤ ±30%	



■ 耐焊接热 Resistance to Soldering Heat

类型 Dielectrics	技术要求 Specification	测试条件 Testing Condition
COG	无明显可见损伤 容量变化在 $\pm 2.5\%$ 或 $\pm 0.25\text{pF}$ (取较大值) 以内 DF 满足产品初始值的要求 IR 满足产品初始值的要求 No remarkable visual damage Cp change within $\pm 2.5\%$ or $\pm 0.25\text{pF}$ , whichever is larger. DF meets initial standard value. IR meets initial standard value.	焊接温度: $270\pm 5^\circ\text{C}$ 预热: $120\sim 150^\circ\text{C}$ 60 秒 浸入时间 : $10\pm 1$ 秒 在室温下放置 $24\pm 2$ (COG) 或 $48\pm 4$ (X7R、X5R、Y5V、X7T、X6S) 小 时以后测量 试验后在标准条件下恢复
X7R/X5R/X7T  /X6S	无明显可见损伤 容量变化在 $\pm 7.5\%$ 以内 DF 满足产品初始值的要求 IR 满足产品初始值的要求 No remarkable visual damage Cp change within $\pm 7.5\%$ DF meets initial standard value. IR meets initial standard value.	*高介电常数电容器的初始值测量 在 $140\sim 150^\circ\text{C}$ 进行 1 小时的热处理后在室 温下放置 $48\pm 4$ 小时 测量初始值 Soldering temperature: $270\pm 5^\circ\text{C}$ Preheating: $120\sim 150^\circ\text{C}$ 60sec. Dipping time: $10\pm 1$ seconds. Measurement to be made after being kept at room temperature for $24\pm 2$ (COG) or $48\pm 4$ (X7R, X5R, Y5V、X7T、X6S) hours.
Y5V	无明显可见损伤 容量变化在 $\pm 20\%$ 以内 DF 满足产品初始值的要求 IR 满足产品初始值的要求 No remarkable visual damage Cp change within $\pm 20\%$ DF meets initial standard value. IR meets initial standard value	Recovery for the following period under the standard condition after test. *Initial measurement for high dielectric constant type Perform a heat treatment at $140\sim 150^\circ\text{C}$ for 1hr and let sit for $48\pm 4$ hrs at room temperature. Perform the initial measurement.

■ 温度快速循环 Temperature Cycle

类型 Dielectrics	技术要求 Specification	测试条件 Testing Condition
COG	<p>无明显可见损伤</p> <p>容量变化在<math>\pm 2.5\%</math>或 <math>\pm 0.25\text{pF}</math> (取较大值) 以内</p> <p>No remarkable visual damage</p> <p>Cp change within <math>\pm 2.5\%</math> or <math>\pm 0.25\text{pF}</math>, whichever is larger.</p>	<p>按下列步骤进行 5 次循环: To perform 5 cycles of the stated environment</p> <p>步骤温度 Step Temperature</p> <p>下限类别温度 <math>+0/-3^\circ\text{C}</math></p> <p><math>25^\circ\text{C}</math></p> <p>上限类别温度 <math>+3/-0^\circ\text{C}</math></p> <p><math>25^\circ\text{C}</math></p>
X7R/X5R/X7T /X6S	<p>无明显可见损伤</p> <p>容量变化在<math>\pm 7.5\%</math>以内</p> <p>No remarkable visual damage</p> <p>Cp change within <math>\pm 7.5\%</math></p>	<p>在室温下放置 <math>48\pm 4</math> (X7R, X5R, Y5V、X7T、X6S) 小时以后测量</p> <p>*高介电常数电容器的初始值测量在 <math>140\sim 150^\circ\text{C}</math> 进行 1 小时的热处理后在室温下放置 <math>48\pm 4</math> 小时测量初始值</p> <p>Measurement to be made after being kept at room temperature for <math>24\pm 2\text{hrs}</math> (COG) or <math>48\pm 4\text{hrs}</math> (X7R, X5R, Y5V、X7T、X6S) at room temperature, then measure.</p> <p>*Initial measurement for high dielectric constant type</p> <p>Perform a heat treatment at <math>140\sim 150^\circ\text{C}</math> for 1hr and let sit for <math>48\pm 4\text{hrs}</math> at room temperature. Perform the initial measurement.</p>
Y5V	<p>无明显可见损伤</p> <p>容量变化在<math>\pm 20\%</math>以内</p> <p>No remarkable visual damage</p> <p>Cp change within <math>\pm 20\%</math></p>	<p>Measurement to be made after being kept at room temperature for <math>24\pm 2\text{hrs}</math> (COG) or <math>48\pm 4\text{hrs}</math> (X7R, X5R, Y5V、X7T、X6S) at room temperature, then measure.</p> <p>*Initial measurement for high dielectric constant type</p> <p>Perform a heat treatment at <math>140\sim 150^\circ\text{C}</math> for 1hr and let sit for <math>48\pm 4\text{hrs}</math> at room temperature. Perform the initial measurement.</p>

■ 温度快速循环 Temperature Cycle

类型 Dielectrics	技术要求 Specification	测试条件 Testing Condition
COG	<p>外观无明显可见损伤</p> <p>容量变化在±5%或 ±0.5pF (取较大值) 以内 Cp&lt;10pF, Q≥200+10Cp; 10≤Cp&lt;30pF, Q≥275+2.5Cp Cp≥30pF, Q≥350</p> <p>IR: 大于 1000MΩ或 10Ω·F(取较小值)</p> <p>No remarkable visual damage</p> <p>Cp change within ±5% or ±0.5pF, whichever is larger.</p> <p>Cp&lt;10pF, Q≥200+10Cp; 10≤Cp&lt;30pF, Q≥275+2.5Cp Cp≥30pF, Q≥350</p> <p>R*C≥1000MΩ or 10Ω·F, whichever is smaller</p>	<p>测试温度: 40±2℃</p> <p>湿度: 90~95% RH</p> <p>测试时间: 500 ±12hrs</p> <p>在室温下放置 24±2 (COG) 或 48±4(X7R、X5R、Y5V、X7T、X6S) 小时以 后测量*高介电常数电容器的初始值测量在 140~ 150℃进行 1 小时的热处理后在室温下 放置 48±4 小时测量初始值</p>
X7R/X5R/X7T /X6S	<p>外观无明显可见损伤</p> <p>容量变化在±12.5%以内</p> <p>DF 为初始值的 2 倍以下</p> <p>IR:大于 1000MΩ或 10Ω·F(取较小值)</p> <p>Cp change within ±12.5%</p> <p>DF:Not more than 2 times of initial value R*C≥1000MΩ or 10Ω·F, whichever is smaller</p>	<p>Test temperature: 40±2℃</p> <p>Humidity: 90~95% RH</p> <p>Testing time: 500 ±12hrs</p> <p>Measurement to be made after being kept at room temperature for 24±2hrs (COG) or 48±4hrs (X7R, X5R, Y5V, X7T, X6S)</p> <p>*Initial measurement for high dielectric constant type</p>
Y5V	<p>外观无明显可见损伤</p> <p>容量变化在±30%以内</p> <p>DF 为初始值的 1.5 倍以下</p> <p>IR:大于 1000MΩ或 10Ω·F(取较小值)</p> <p>No remarkable visual damage</p> <p>Cp change within ±30%</p> <p>DF :Not more than 1.5 times of initial value R*C≥1000MΩ or 10Ω·F, whichever is smaller</p>	<p>Perform a heat treatment at 140~ 150 °C for 1hr and let sit for 48±4hrs at room temperature. Perform the initial measurement. Perform the initial measurement.</p>

■ 耐湿负荷 Damp heat with load

类型 Dielectrics	技术要求 Specification	测试条件 Testing Condition
COG	外观无明显可见损伤 容量变化在 $\pm 7.5\%$ 或 $\pm 0.75\text{pF}$ (取较大值) 以内 $C_p < 30\text{pF}$ , $Q \geq 100 + 10/3 \cdot C_p$ $C_p \geq 30\text{pF}$ , $Q \geq 200$ IR: 大于 $500\text{M}\Omega$ 或 $5\Omega \cdot F$ (取较小值) No remarkable visual damage $C_p$ change $\leq \pm 7.5\%$ or $\pm 0.75\text{pF}$ , whichever is larger. $C_p < 30\text{pF}$ , $Q \geq 100 + 10/3 \cdot C_p$ $R \cdot C \geq 500\text{M}\Omega$ or $5\Omega \cdot F$ , whichever is smaller	测试温度: $40 \pm 2^\circ\text{C}$ 湿度: 90~95% RH 电压: 额定电压 测试时间: $500 \pm 12\text{hrs}$
X7R/X5R/X7T /X6S	外观无明显可见损伤 容量变化在 $\pm 12.5\%$ 以内 DF 为初始值的 2 倍以下 IR: 大于 $500\text{M}\Omega$ 或 $5\Omega \cdot F$ (取较小值) No remarkable visual damage $C_p$ change $\leq \pm 12.5\%$ DF :Not more than 2 times of initial value $R \cdot C \geq 500\text{M}\Omega$ or $5\Omega \cdot F$ , whichever is smaller	在室温下放置 $24 \pm 2$ (COG) 或 $48 \pm 4$ (X7R、X5R、Y5V、X7T、X6S) 小时以后测量 *在 $40 \pm 2^\circ\text{C}$ 温度下, 将电容器加额定直流电压 1hrs. 去掉电压, 将电容器在室温下放置 $48 \pm 4\text{hrs}$ 测量初始电容值。 Test temperature: $40 \pm 2^\circ\text{C}$ Humidity: 90~95% RH Voltage: 100% of the rated voltage Testing time: $500 \pm 12\text{hrs}$ Measurement to be made after being kept at room temperature for $24 \pm 2\text{hrs}$ (COG) or $48 \pm 4\text{hrs}$ (X7R, X5R, Y5V, X7T, X6S)
Y5V	外观无明显可见损伤 容量变化在 $\pm 30\%$ 以内 DF 为初始值的 1.5 倍以下 IR: 大于 $500\text{M}\Omega$ 或 $5\Omega \cdot F$ (取较小值) No remarkable visual damage $C_p$ change $\leq \pm 30\%$ DF:Not more than 1.5 times of initial value value $R \cdot C \geq 500\text{M}\Omega$ or $5\Omega \cdot F$ , whichever is smaller	*Apply the rated DC voltage for 1 hour at $40 \pm 2^\circ\text{C}$ . Remove and let sit for $48 \pm 4\text{hrs}$ at room temperature. Perform the initial measurement.
备注: 该项可靠性试验仅适用于常规产品, 不适用于中高压产品。		

■ 耐久性 Life Test

类型 Dielectrics	技术要求 Specification	测试条件 Testing Condition
COG	外观无明显可见损伤 容量变化在±3%或±0.3pF (取较大值) 以内 容量在 30pF 以上, $Q \geq 350$ 容量在 10pF 以上且小于 30 pF , $Q \geq 275 + (2.5 * C_p)$ 容量小于 10pF, $Q \geq 200 + 10 * C_p$ IR: 大于 1000MΩ 或 5Ω·F (取较小值) No remarkable visual damage Cp change ≤ ±3% or ±0.3pF, whichever is larger. $Q \geq 350$ ( $C_p \geq 30$ pF) $Q \geq 275 + (2.5 * C_p)$ (10 pF ≤ $C_p$ < 30 pF) $Q \geq 200 + 10 * C_p$ ( $C_p$ < 10 pF) $R * C \geq 1000M\Omega$ or 5Ω·F, whichever is smaller	测试温度: 上限类别温度±3℃ 电压: $U_R < 100V$ 1.5 倍额定电压 测试时间: 1000 小时 在室温下放置 24±2 (COG) 或 48±4 (X7R、X5R、Y5V、X7T、X6S) 小时以后测量 *高介电常数电容器的初始值测量 在上限类别温度±3℃, 将电容器加 1.5 倍额定直流电压 1 小时 去掉电压, 将电容器在室温下放置 48±4hrs 测量初始电容值
X7R/X5R/X7T  /X6S	外观无明显可见损伤 容量变化在±12.5%以内 DF 为初始值的 2 倍以下 IR: 大于 1000MΩ 或 5Ω·F (取较小值) No remarkable visual damage Cp change ≤ ±12.5% DF: Not more than 2 times of initial value $R * C \geq 1000M\Omega$ or 5Ω·F, whichever is smaller	Test temperature: Max. Operating Temp. ±3℃ Voltage: $U_R < 100V$ 150% of the rated voltage Testing time: 1000 hrs Measurement to be made after being kept at room temperature for 24±2hrs (COG) or 48±4hrs (X7R, X5R, Y5V, X7T, X6S) *Initial measurement for high dielectric constant type
Y5V	外观无明显可见损伤 容量变化在±30%以内 DF 为初始值的 1.5 倍以下 IR: 大于 1000MΩ 或 5Ω·F (取较小值) No remarkable visual damage Cp change ≤ ±30% DF: Not more than 1.5 times of initial value $R * C \geq 1000M\Omega$ or 5Ω·F, whichever is smaller	Apply 150% of the rated DC voltage for one hour at the maximum operating temperature ±3℃. Remove and let sit for 48±4hrs at room temperature. Perform the initial measurement

备注: 该项可靠性试验仅适用于常规产品, 不适用于中高压产品。

## 产品包装 Packing

### ■ 袋式散装 Bulk Packing

10000 个/袋或按客户要求。Standard packing 10Kpcs/bag; others are according to customer request.

### ■ 编带式包装 Tape Packing

规格 Type	尺寸 Size (mm)			编带数量(个/盘 pcs/reel)	
	长度L	宽度W	厚度T	纸带 Paper Tape	塑料带 Plastic Tape
0201	0.6	0.3	0.3	15,000	N/A
0402	1.0	0.5	0.5	10,000	N/A
0603	1.6	0.8	0.8	4,000	N/A
0805	2.0	1.25	≤0.85	4,000	N/A
			>0.85	N/A	2,000 (或3,000)
1206	3.2	1.6	≤0.85	4,000	N/A
			>0.85	N/A	2,000 (或3,000)
1210	3.2	2.5	≤1.25	N/A	2,000
			>1.25	N/A	2,000

### ■ 纸带尺寸 Dimensions of Packing Paper

Type	A	B	C	D	T
0201	0.36±0.03	0.67±0.03	2.0±0.10	2.0±0.05	0.42max
0402	0.65±0.10	1.15±0.10	2.0±0.05	2.0±0.05	0.8max
0603	1.05±0.10	1.85±0.10	4.0±0.10	2.0±0.10	1.1max
0805	1.55±0.15	2.3±0.15	4.0±0.10	2.0±0.10	1.1max
1206	1.95±0.15	3.5±0.15	4.0±0.10	2.0±0.10	1.1max

单位unit:毫米mm

■ 塑料带尺寸 Dimensions of Embossed Packing

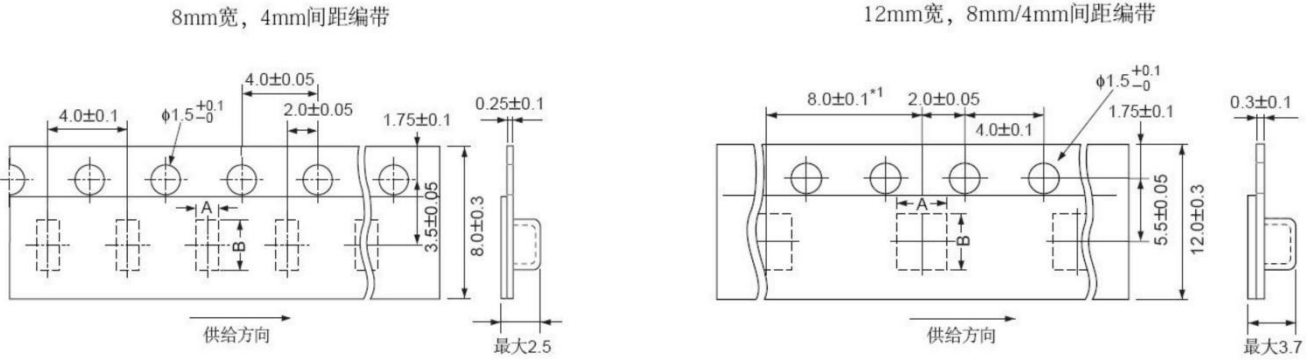

A:  $1.45 \pm 0.20$     B:  $2.25 \pm 0.20$  (0805)    A:  $1.95 \pm 0.20$     B:  $3.50 \pm 0.20$  (1206)  
 A:  $2.90 \pm 0.20$     B:  $3.60 \pm 0.20$  (1210)

单位unit:毫米mm

■ 编带盘尺寸 Dimensions of Reel

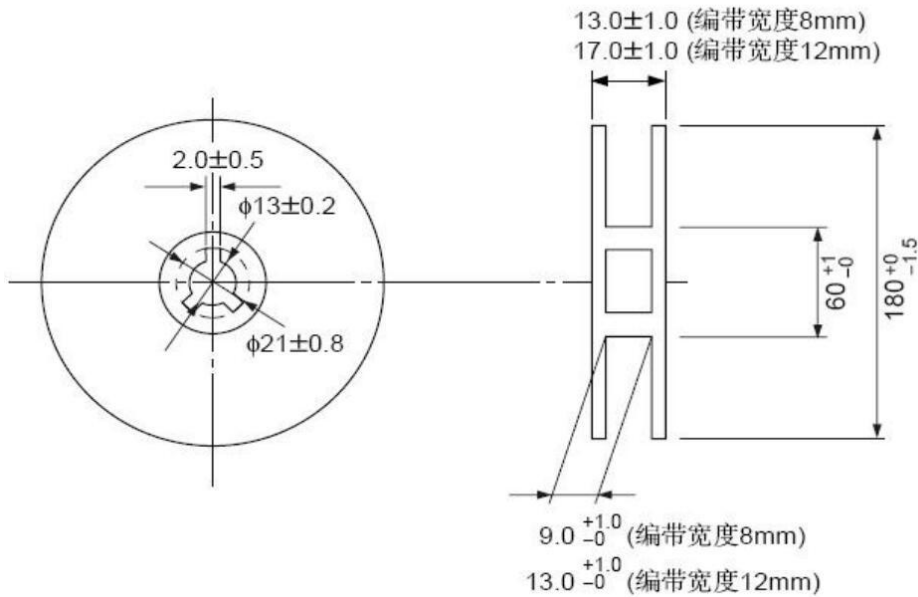

## ■ 编带方式 Taping Figure

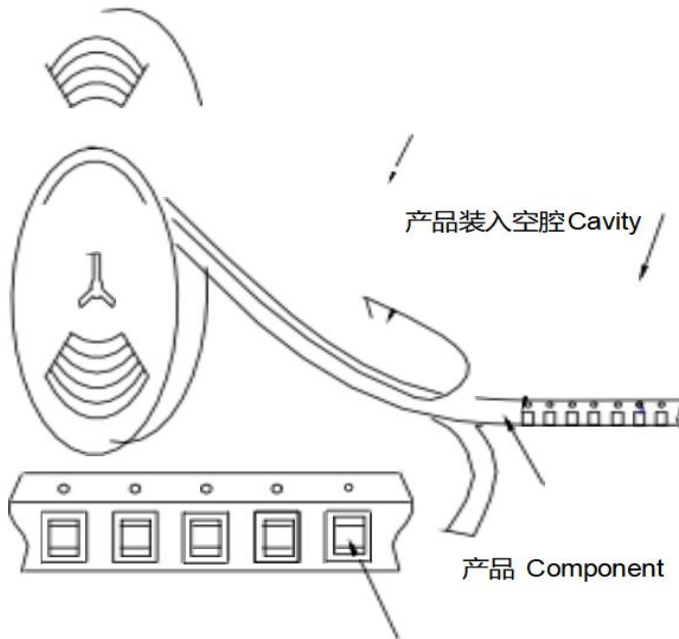

空白部分 Empty section    产品装入部分 Chip insertion section    空白部分 Empty section

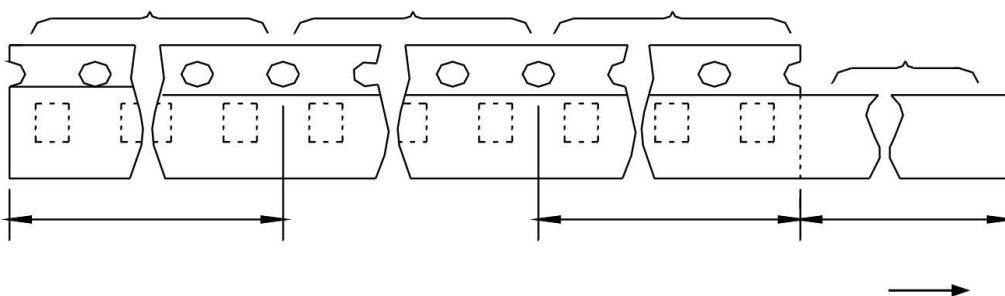

## ■ 编带方法 Taping Method

- 1 包装电容器的编带是顺时针卷绕的，由上往下的方向拉出编带时，传送孔处于编带的右侧。
- 2 在编带的前端，至少留出 5 个间距的引出带。
- 3 在编带时，必须上图留出引带部分或空白部分。
- 4 在盘带的安装中的产品装错的数量每盘必须小于表示数量的 0.1% 或 1 个为限，不连续发生错误。
- 5 上胶带和下胶带不应超出编带的边缘，不能挡住传送孔。
- 6 传送孔的累计误差为 10 个间距：±0.3 毫米以内。
- 7 上胶带的剥离力矩应在 0.1 至 0.6 牛顿以内，其方向如下图所示。

① Tapes for capacitors are wound clockwise. The sprocket holes are to the right as the tape is pulled toward the user.

② The top tape and base tape are not attached at the end of the tape for a minimum of 5 pitches.

③ Part of the leader and part of the empty tape shall be attached to the end of the tape as follows.

④ Missing capacitors number within 0.1% of the number per reel or 1pc, whichever is greater, and are not continuous.



- ⑤ The top tape and bottom tape shall not protrude beyond the edges of the tape and shall not cover sprocket holes.
- ⑥ Cumulative tolerance of sprocket holes, 10 pitches:  $\pm 0.3\text{mm}$ .
- ⑦ Peeling off force: 0.1 to 0.6N in the direction shown down.

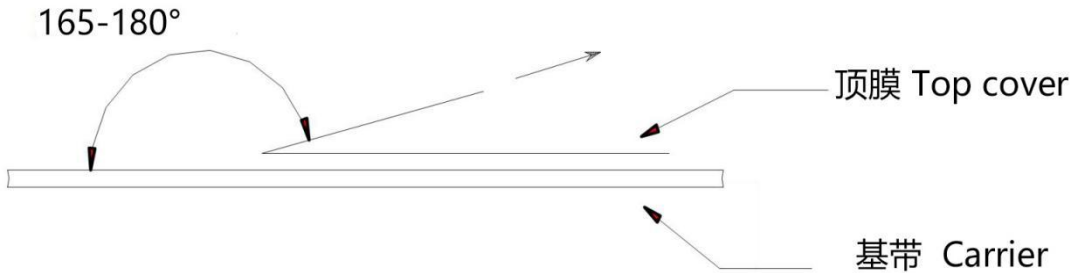

■ 产品标签 Reel Label

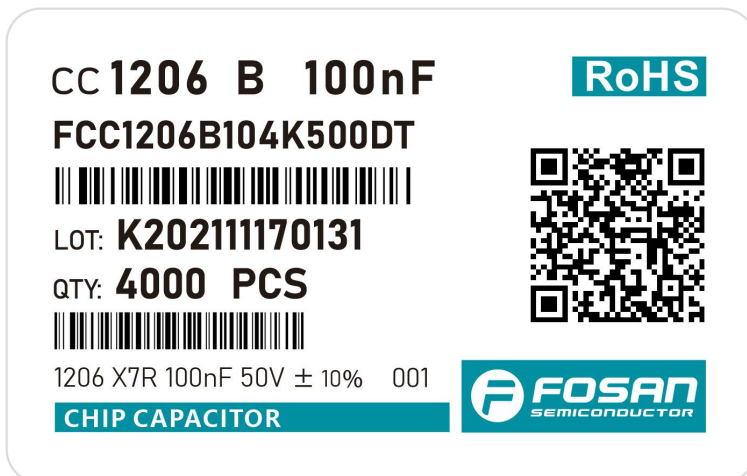

标签内容 The Contents of Label

(1) FCC    1206    B            104            K            500            D            T                  
           ①            ②            ③            ④            ⑤            ⑥            ⑦            ⑧            ⑨

- ① 陶瓷电容器代号 Code of Ceramic Capacitor
- ② 尺寸 chip size, ③ 温度特性 dielectrics, ④ 容量 capacitance, ⑤ 容量容差 tolerance,
- ⑥ 额定电压 rated voltage, ⑦ 厚度 thickness, ⑧ 包装 packing ⑨ 特殊码
- (2) 产品批号 Lot: K20211170131
- (3) 数量 Qty: 4000pcs
- (4) RoHS: GREEN PARTS 绿色物料

- 外包装 Package
- 包装箱 Carton
- 包装箱尺寸 Carton Size

L	W	H
41.0cm	38.5cm	20.2cm

■ 数量： 240Kpcs /箱 The Quantity: 240Kpcs /one carton

1 内包装盒=40,000PCS            1 INNER BOX=40,000PCS

1 包装箱 =40,000PCS × 6 包装盒=240,000PCS            1 CARTON=40,000PCS × 6 INNER BOX  
=240,000PCS RoHS 标识(根据客户要求张贴)            according to customer request

- 内包装盒 Inner Box
- 包装盒尺寸 Size

L	W	H
18.5cm	6.5cm	19cm

■ 数量： 40Kpcs /盒

1 盘=4000PCS            1 REEL=4,000PCS

1 包装盒=4,000PCS × 10 盘 =40,000PCS            1 INNER BOX=4,000PCS × 10REEL =40,000PC

## MLCC 使用注意事项 Precautions on the use of MLCC

- 电路板设计 PCB Design
- 电路板图案设计 Design of Land-patterns

下面图和表格给出了部分推荐的设计图案，可以防止安装时焊锡量过多。

同时也给出了不正确的图案。

The following diagrams and tables show some examples recommended patterns to prevent excessive solder amounts (larger fillets which above the component end terminations)

Examples of improper pattern designs are also shown.

电路板设计推荐图案尺寸：|

Recommended land dimensions for a typical chip capacitor land patterns for PCBs

波峰焊接时推荐设计的尺寸 (单位: mm):

Recommended land dimensions for wave-soldering (unit: mm)

回流焊接时推荐设计的尺寸 (单位: mm)

规格 SIZE		0603	0805	1206
尺寸	L	1.6	2.0	3.2
	W	0.8	1.25	1.6
A		0.8~1.0	1.0~1.4	1.8~2.5
B		0.5~0.8	0.8~1.5	0.8~1.7
C		0.6~0.8	0.9~1.2	1.2~1.6

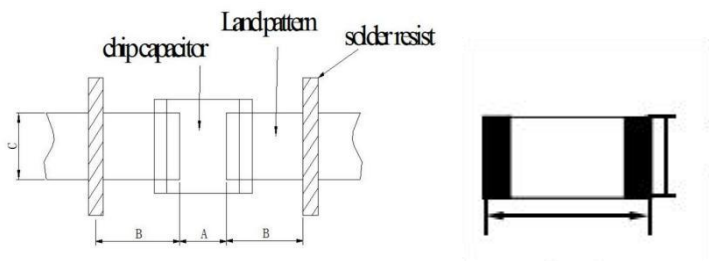

Recommended land dimensions for reflow-soldering (unit: mm)

规格 SIZE		0201	0402	0603	0805	1206	1210
尺寸	L	0.6	1.0	1.6	2.00	3.2	3.2
	W	0.3	0.5	0.8	1.25	1.6	2.5
A		0.20~0.25	0.35~0.45	0.6~0.8	0.8~1.2	1.8~2.5	1.8~2.5
B		0.20~0.30	0.40~0.50	0.6~0.8	0.8~1.2	1.0~1.5	1.0~1.5
C		0.25~0.35	0.45~0.55	0.6~0.8	0.9~1.6	1.2~2.0	1.6~3.2

过量的焊锡会影响产品抵抗机械应力的能力，因此在设计图案时应引起注意。

Excess solder can affect the ability of chips to withstand mechanical stresses. Therefore, please take proper precautions when designing land-patterns.

在应用中一些焊接好与坏的情况:

Examples of good and bad solder application

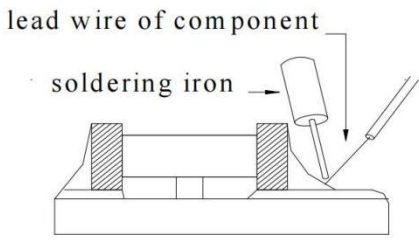
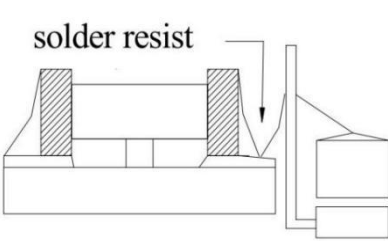
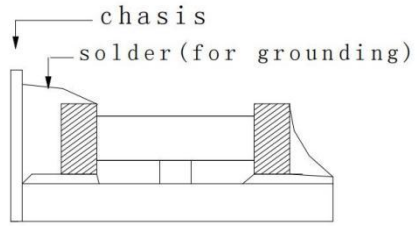
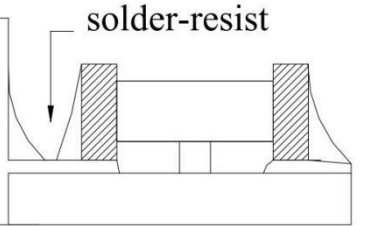
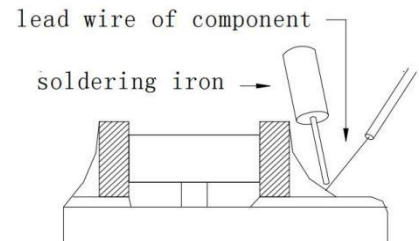
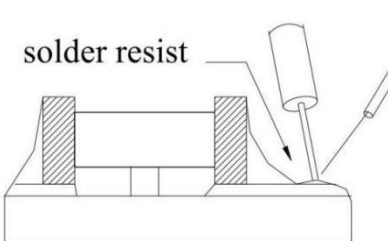
项目 Item	不推荐结构 Not recommended	推荐结构 Recommended
片状元件和带引线的元件的混合焊接 Mixed mounting of SMD and leaded component		
靠近底座的焊接 Component placement close to the chassis		
在片状元件附近带引线元件的焊接 Hand-soldering of leaded components near mounted components		

## ■ 图案结构 Pattern configurations

下面是电容器安装好与坏的例子。选择贴装位置，应尽可能减小电路板在弯曲时受到的机械应力。

The following are examples of good and bad capacitor layout, SMD capacitors should be located to minimize any possible mechanical stresses from board warp or deflection.

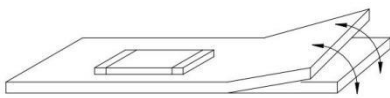
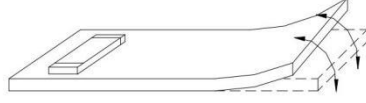
	不推荐结构 Not recommended	推荐结构 Recommended
电路板弯曲 Deflection of the board		

对于电路板分拨的电容器，在分拨时受到的机械应力大小与电容器的安装有关。下面推荐了一些好的设计。

To layout the capacitors for the breakaway PC board, it should be noted that the amount of mechanical stresses given depending on capacitor layout. The example below shows recommendations for better design.

在沿着分拨线分拨电路板时，对产品施加的机械应力与使用的方法关系很大。分折电路板时片状元件受到的疲劳按照如下顺序增大：分折、剪切、V 型槽、穿孔。因此，贴装时应该考虑电路板的分拨过程。When breaking PC boards along their perforations, the amount of mechanical stress on the capacitors can vary according to the method used. The following methods are listed in order from least stressful to most stressful: push-back, silt, -grooving, and perforation. Thus, any ideal SMD capacitor layout must also consider the PCB splitting procedure.

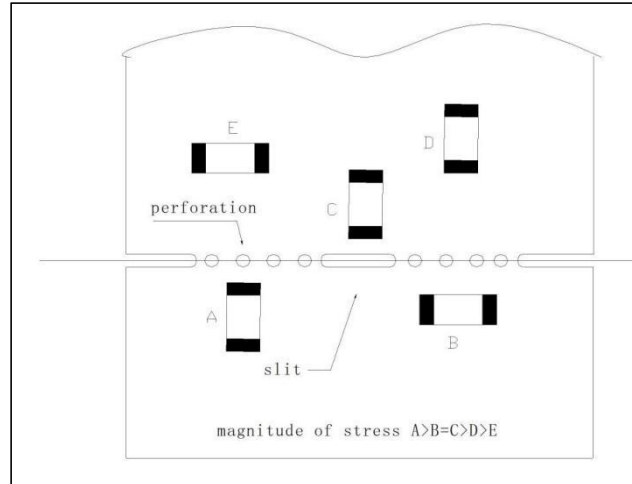

- 自动贴装注意事项 Considerations for automatic placement
- placement 贴装机的调整 Adjustment of mounting machine

- ①.产品在电路板贴装时，不应该受到过大的冲击。
- ②.必须定期对吸头和定位爪进行检查、维修和更换
- ①.Excessive impact load should not be imposed on the capacitors when mounting the PC boards.
- ②.The maintenance and inspection of the mounters should be conducted periodically.

	不推荐结构 Not recommended	推荐结构 Recommended
单面贴装 Single-sided mounting	crack	supporting pin
双面贴装 Double-sided mounting	solder peeling crack	supporting pin

■ 推荐焊接曲线 Recommended soldering profile

■ 说明

- ①.产品推荐使用回流焊接工艺;
- ②.大尺寸产品适用于回流焊接工艺
- ①.flow Soldering is recommended;
- ②.flow soldering is suitable for bigger size MLCC

■ 锡铅焊接曲线 Recommended Sn&Pb soldering profile

回流焊 Reflow soldering

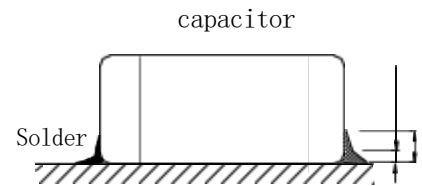
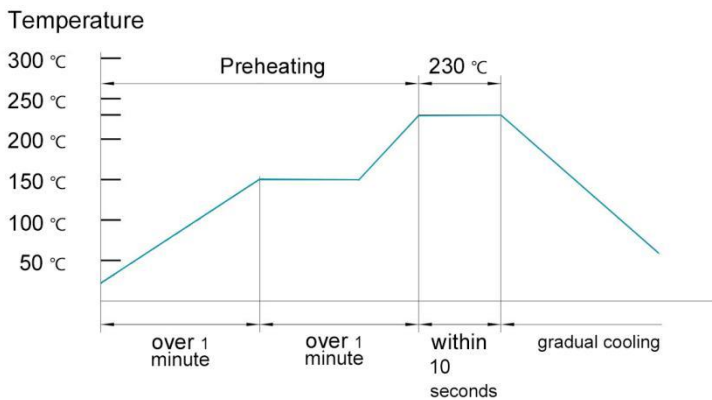

注意 Caution

- ①.理想状况的焊锡高度为电容器厚度的 1/3 ~ 1/2 , 如右图所示:
- ②.过长的焊接时间会影响端头的可焊性, 焊接时间尽可能保持与推荐时间一致。
- ①.The ideal condition is to have solder mass (fillet) controlled to 1/2 to 1/3of the thickness of the capacitor, as shown below:
- ②.Because excessive dwell times can detrimentally affect solder ability, soldering duration should be kept as close to recommended times as possible.

波峰焊 Wave solder profile

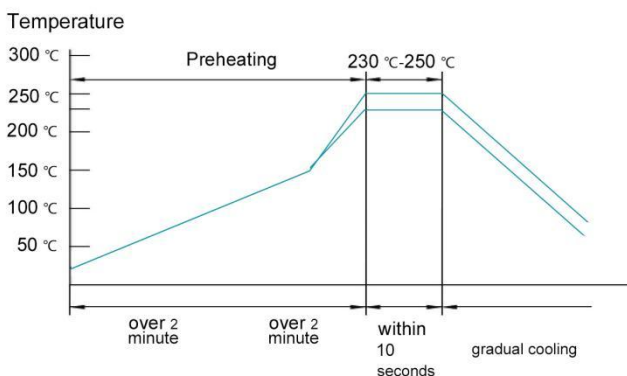

### 注意 Caution

- ①. 确保电容器充分预热。
  - ②. 产品预热和焊接温度差不超过 100~130℃。
  - ③. 焊接后尽可能慢速冷却。
- ①. Make sure the capacitors are preheated sufficiently.
  - ②. The temperature difference between the capacitor and melted solder should not be greater than 100 to 130℃.
  - ③. Cooling after soldering should be gradual as possible.

### 手工焊接 Hand soldering

条件:

预热	烙铁头温度	烙铁功率	烙铁头直径	焊接时间	锡膏量	限制条件
$\Delta \leq 130^{\circ}\text{C}$	最高 350℃	最大 20w	建议 1mm	最长 5s	$\leq \frac{1}{2}$ 芯片厚度	请勿使用烙铁头直接接触陶瓷原件

### 注意 Caution

- ①. 用尖端最大直径 1.0mm 功率 20W 的焊接烙铁。
  - ②. 焊接烙铁不要直接接触产品。
- ①. Use a 20w soldering iron with a maximum tip diameter of 1.0mm.
  - ②. The soldering iron should not directly touch the capacitor.

### ■ 无铅焊接曲线 Recommended Pb-Free soldering profilee

### 回流焊 Reflow solderin

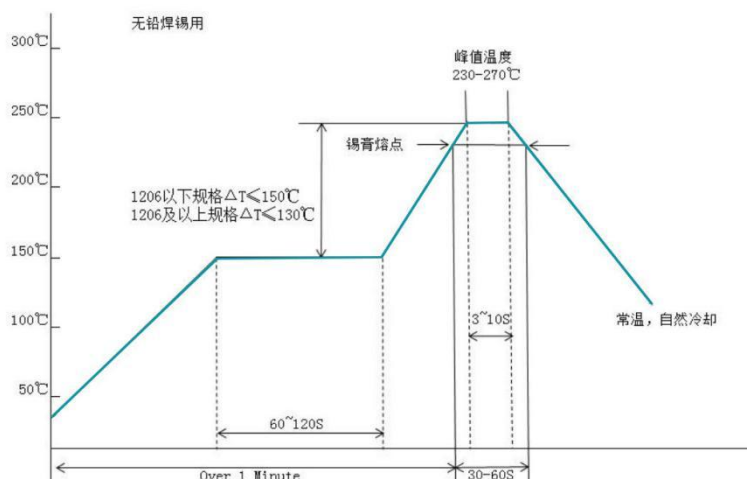

## 波峰焊 Wave solder profile

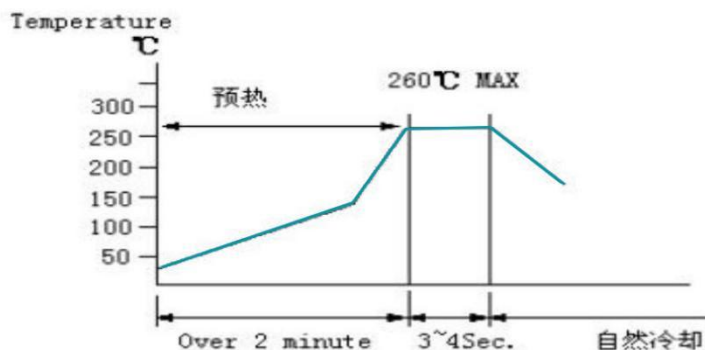

### 分拨电路板 Handling

Breakaway PC boards (splitting along perforations)

①.在电容器或其它贴装后，必须注意因电路板弯曲或变形带来的应力。

②.分拨电路板时必须使用专用的夹具，不可以用手拨断。

① .When splitting the PC board after mounting capacitors and other components, care is required so as not to give any stresses of deflection or twisting to the board.

②.Board separation should not be done manually, but by using the appropriate devices.

### 保存 Storage

①.在下列环境中保存产品：温度 5~40°C；湿度 ≤70% RH

②.产品自生产之日保存期为一年，产品使用之前请勿拆开编带。

③.编带拆开后，产品应在三个月内使用。

④.高介电常数电容器 (X7R,X5R,Y5V、X7T、X6S) 的容值随时间会逐渐减小，所以在电路设计时应充分考虑这一现象。容值减小的电容器在 150°C热处理 1 小时后容值会恢复到初始值。

①. Keep the storage environment conditions as following: Temperature: 5~40°C； Humidity: ≤70% RH

②. Don't open the tape until the parts are to be used, and store them within one year since the date printed on the reel.

③. Use the chips within 3 months after the tape is opened.

④. The capacitance value of high dielectric constant capacitors (X7R,X5R,Y5V、X7T、X6S) will gradually decrease with the passage of time, so this should be taken into consideration in the circuit design. If such a capacitance reduction occurs, a heat treatment of 150°C for 1 hour will return the capacitance to its initial level.





## X-ON Electronics

Largest Supplier of Electrical and Electronic Components

*Click to view similar products for [Multilayer Ceramic Capacitors MLCC - SMD/SMT category:](#)*

*Click to view products by [FOJAN Electronics manufacturer:](#)*

Other Similar products are found below :

[M39014/02-1218V](#) [M39014/02-1225V](#) [M39014/22-0631](#) [D55342E07B523DR-T/R](#) [NIN-FB391JTRF](#) [NIN-FC2R7JTRF](#)  
[NMC0402NPO220J50TRPF](#) [NMC0402X5R105K6.3TRPF](#) [NMC0402X5R224K6.3TRPF](#) [NMC0402X7R103J25TRPF](#)  
[NMC0402X7R153K16TRPF](#) [NMC0603NPO101F50TRPF](#) [NMC0603NPO1R8C50TRPF](#) [NMC0603NPO201J50TRPF](#)  
[NMC0603X5R475M6.3TRPF](#) [NMC0805NPO270J50TRPF](#) [NMC0805NPO681F50TRPF](#) [NMC0805NPO820J50TRPF](#)  
[NMC0805X7R224K16TRPLPF](#) [NMC0805X7R224K25TRPF](#) [NMC1206X7R102K50TRPF](#) [NMC1206X7R475K10TRPLPF](#) [NMC-](#)  
[Q0402NPO8R2D200TRPF](#) [C1206C101J1GAC](#) [C1608C0G2A221J](#) [C1608X7R1E334K](#) [C2012C0G2A472J](#) [2220J2K00562KXT](#)  
[1812J2K00332KXT](#) [CDR04BX104AKSR](#) [CDR31BX103AKWR](#) [CDR33BX104AKUR](#) [CDR33BX683AKUS](#) [CGA2B2C0G1H010C](#)  
[CGA2B2C0G1H040C](#) [CGA2B2C0G1H050C](#) [CGA2B2C0G1H060D](#) [CGA2B2C0G1H070D](#) [CGA2B2C0G1H120J](#) [CGA2B2C0G1H151J](#)  
[CGA2B2C0G1H1R5C](#) [CGA2B2C0G1H2R2C](#) [CGA2B2C0G1H390J](#) [CGA2B2C0G1H391J](#) [CGA2B2C0G1H3R3C](#) [CGA2B2C0G1H680J](#)  
[CGA2B2C0G1H6R8D](#) [CGA2B2C0G1H820J](#) [CGA2B2X8R1H152K](#) [CGA2B2X8R1H221K](#)