



FOJAN
富捷电阻

安徽省富捷电子科技有限公司
ANHUI FOJAN ELECTRONICS TECHNOLOGY CO., LTD



安徽省富捷电子科技有限公司

富捷电子坐落于安徽省马鞍山市郑蒲港半导体高新科技产业园区。是一家集贴片电阻设计研发，生产，销售于一体的民营高新科技企业。

富捷电子具有国际专业的晶片电阻核心技术研发团队和拥有遍及全球的销售网络。历经二十余年丰富的电阻设计研发、生产管理经验，研发团队依据贴片电阻元器件的技术设计理论,遵循国际国内法律法规要求(RoHs)及更遵循国际品质最高规范(JIS & AEC_Q200)。

富捷电子的主要产品包括贴片厚膜电阻、薄膜电阻、合金电阻、超低阻、车规电阻、抗硫化电阻等，产品广泛应用于全球微电子、计算机、光伏、新能源、车载等众多新兴和高科技领域。

富捷已成功导入ISO9001/IATF16949及VDA6.3质量管理体系，ISO14001环境管理体系，从原材料管理(IQC)，产品生产，产品过程检验(FQC/OQC)及出货流程皆严格遵循体系要求，秉持全面质量管理(TQM)精神，通过对制程生产规范化管理及品质检验,创造客户满意的产品及服务。

富捷电子与富信半导体致力于成为世界一流的电子元器件整合配套供应商及解决方案提供商，为客户提供一次购齐的产品服务和技术支持,努力为客户创造价值,为员工提供平台，为社会做出贡献。



我们的使命

通过提供可信赖的产品和服务，为顾客、企业成员和合作伙伴创造价值

我们的愿景

以产品和服务成为电子制造业卓越的全球供货商。做客户、企业成员、合作伙伴尊敬的企业



目录 CONTENTS

| | |
|--|-------|
| ■ 常规系列厚膜晶片电阻 Thick Film Chip Resistor —FRC Series | 01/06 |
| ■ 高功率厚膜晶片电阻 High Power Thick Film Chip Resistor —FRP Series | 07/11 |
| ■ 高压厚膜晶片电阻 High Voltage Thick Film Chip Resistor —FRV Series | 12/16 |
| ■ 低阻厚膜晶片电阻 Low Resistance Thick Chip Resistor —FRL Series | 17/22 |
| ■ LED 厚膜晶片电阻 Thick Chip Resistor Product FOR LED —FRD Series | 23/27 |
| ■ 车用厚膜晶片电阻 Automotive Thick Chip Resistor —FRQ Series | 28/34 |
| ■ 抗浪涌厚膜晶片电阻 Anti-Surge Thick Chip Resistor —FRS Series | 35/41 |
| ■ 晶片厚膜排列电阻 Thick Film Chip Resistor Array —FRA Series | 42/46 |
| ■ 抗硫化厚膜晶片电阻 Anti-sulfur Thick Film Chip Resistor —FRR Series | 47/52 |
| ■ 高精度厚膜晶片电阻 High Precision Thick Film Chip Resistor —FRH Series | 53/58 |
| ■ 电阻本体字码标识 Marking on the Resistor's Body | 59/61 |
| ■ 包装规格 Tapping Specification | 62/63 |
| ■ 包装材料资料/储存资料 Packing Material Data/Storage Data | 64 |
| ■ 焊接 Soldering | 65 |

**常规系列厚膜晶片电阻
Thick Film Chip Resistor
FRC Series**



■应用 (Application)

- Entertainment : Stereo,TV tuners , Tape recorder
- Appliance: Air conditioner, Refrigerator
- Computer & relative products : Main board, PDA
- Communication equipment: Cell phone, Fax machine
- Power equipment: Power supply , II Lumination equipment
- Measuring instrument: Electric meter,Navigation equipment

- 娱乐：立体声、电视调谐器、录音机
- 电器：空调、冰箱
- 电脑及相关产品：主板、PDA
- 通讯设备：手机、传真机
- 电源设备：电源、二级照明设备
- 测量仪器：电表、导航设备

■特点 (Features)

- small size and light weight
- Reliability, high quality

- 体积小、重量轻
- 可靠性，高质量

■产品料号 (Parts Number Explanation)

示例 (Example) : FRC1206F1001 TSD

| F 公司名 | R 产品别 | C 功能别 | 1206 尺寸 | F 公差 | 1001 字码 | T 包装别 | S 端电极 | D 特殊码 |
|-----------------|--|---|--|---|---|--|----------------------------|---------------------|
| FOJAN | R:Resistor C:Capacitor L:Inductor D:Diode A:Audion | C:Normal P:Hi-Power L:Lowohmic A:Array S:Surge H:Hi-Precision V:Hi-Voltage Q:Auto-motive R:Anti-sulfur M:Metal D: LED | 0201 0402 0603 0805 1206 1210 1218 1812 2010 2512 | B:±0.1% C:±0.25% D:±0.5% F:±1% J:±5% P: Jumper | ±5%:E24 3-digits+blank 102=1KΩ 1R0=1Ω ±1%&Below : E24+E96 : 4-digits 1001=1KΩ 1R00=1Ω | T: 7 inch reel Q:10 inch reel R:13 inch reel B:Bulk | S : Sn C : Cu A : Au | N:Normal D : LED |
| Company code | Type code | Functional code | Size code | Tolerance code | Resistance code | Packaging code | Termination code | Special Case |

■尺寸 (Dimension)

| 尺寸 dimension |  | | | | |
|-----------------|--|-----------|-----------|-----------|-----------|
| | 单位 (unit) : mm | | | | |
| 型别 (Type) | L | W | H | T1 | T2 |
| 0201 | 0.60±0.03 | 0.30±0.03 | 0.23±0.03 | 0.10±0.05 | 0.15±0.05 |
| 0402 | 1.00±0.05 | 0.50±0.05 | 0.35±0.05 | 0.20±0.10 | 0.25±0.10 |
| 0603 | 1.60±0.10 | 0.80±0.10 | 0.45±0.10 | 0.25±0.15 | 0.25±0.15 |
| 0805 | 2.00±0.10 | 1.25±0.10 | 0.50±0.10 | 0.35±0.20 | 0.35±0.20 |
| 1206 | 3.10±0.10 | 1.60±0.10 | 0.55±0.10 | 0.45±0.20 | 0.40±0.20 |
| 1210 | 3.10±0.10 | 2.60±0.15 | 0.55±0.10 | 0.45±0.15 | 0.50±0.20 |
| 1218 | 3.10±0.10 | 4.60±0.10 | 0.55±0.10 | 0.45±0.20 | 0.40±0.20 |
| 1812 | 4.50±0.20 | 3.10±0.20 | 0.55±0.10 | 0.55±0.20 | 0.70±0.20 |
| 2010 | 5.00±0.10 | 2.50±0.15 | 0.55±0.10 | 0.45±0.15 | 0.50±0.20 |
| 2512 | 6.35±0.10 | 3.10±0.15 | 0.55±0.10 | 0.60±0.20 | 0.50±0.20 |

■电阻结构 (Construction)



| NO. | 结构 construction | 主要材料 Major material |
|-----|--------------------------------|---|
| 1 | 陶瓷基板 Ceramic substrate | 三氧化二铝 Al ₂ O ₃ |
| 2 | 银电极 Conductive layer | 银 Ag |
| 3 | 侧电极 Side conductive layer | 镍铬合金 NiCr |
| 4 | 阻体层 Resistive layer | 氧化钌+玻璃 RuO ₂ + glass |
| 5 | 内保护层 Inner protective layer | 玻璃 Glass |
| 6 | 外保护层 Outer Protective layer | 环氧树脂 Epoxy |
| 7 | 文字 Marking | 环氧树脂 Epoxy |
| 8 | 镍电极 Ni plating layer | 镍 Ni |
| 9 | 锡电极 Sn plating layer | 锡 Matte Tin |

■功率衰减曲线 (Derating Curve)

| 使用温度范围 | -55°C~+125°C(0201) | -55°C~+155°C |
|---------|----------------------------------|----------------------------------|
| 说明 | 周围温度若超过70°C至125°C之间,功率可照下图曲线予以修订 | 周围温度若超过70°C至155°C之间,功率可照下图曲线予以修订 |
| 功率衰减曲线图 | | |

■电气特性 (Electrical characteristics)

| 型别 Type | 0201 | 0402 | 0603 | 0805 | 1206 | 1210 | 1218 | 1812 | 2010 | 2512 |
|---|-------|-------|-------|-------|-------|-------|-------|-------|-------|-------|
| 绝缘耐压 Dielectric Withstanding Voltage | - | 100V | 100V | 300V | 500V | 500V | 500V | 500V | 500V | 500V |
| 零欧姆阻值 ±1% Resistance Value of Jumper ±1% | - | <30mΩ | <30mΩ | <30mΩ | <30mΩ | <30mΩ | <30mΩ | <30mΩ | <30mΩ | <30mΩ |
| 零欧姆阻值 ±5% Resistance Value of Jumper ±5% | <50mΩ | <50mΩ | <50mΩ | <50mΩ | <50mΩ | <50mΩ | <50mΩ | <50mΩ | <50mΩ | <50mΩ |
| 零欧姆额定电流 Rated Current of Jumper | 0.5A | 1A | 1A | 2A | 2A | 2A | 6A | 2A | 2A | 2A |
| 零欧姆电阻最大电流 Max Current of Jumper | 1A | 2A | 2A | 5A | 10A | 10A | 10A | 10A | 10A | 10A |

■电性规格 (Standard Electrical Specifications)

| 型别 Type | 额定功率 (PowerRating at 70℃) | 最高 工作电压 Max. RCWV | 最大过负荷电压 Max. Overload Voltage | T.C.R. (PPM/°C) | 阻值范围 Resistance Range |
|------------|-----------------------------------|-------------------------|----------------------------------|--------------------|--------------------------|
| 0201 | 1/20W | 25V | 50V | ± 400 | 1Ω~10Ω |
| | | | | ± 200 | 10Ω~10MΩ |
| 0402 | 1/16W | 50V | 100V | ±200 | 1Ω~10Ω |
| | | | | ± 100 | 10MΩ~100MΩ |
| 0603 | 1/10W | 75V | 150V | ± 200 | 10Ω~10MΩ |
| | | | | ± 100 | 1Ω~10Ω |
| 0805 | 1/8W | 150V | 300V | ± 200 | 10MΩ~100MΩ |
| | | | | ± 100 | 1Ω~10Ω |
| 1206 | 1/4W | 200V | 400V | ± 200 | 10Ω~10MΩ |
| | | | | ± 100 | 1Ω~10Ω |
| 1210 | 1/3W | 200V | 400V | ± 200 | 10MΩ~100MΩ |
| | | | | ± 100 | 1Ω~10Ω |
| 1218 | 1W | 200V | 500V | ± 200 | 10Ω~1MΩ |
| | | | | ± 100 | 1Ω~10Ω |
| 1812 | 3/4W | 200V | 400V | ± 200 | 10MΩ~100MΩ |
| | | | | ± 100 | 1Ω~10Ω |
| 2010 | 3/4W | 200V | 400V | ± 200 | 10Ω~10MΩ |
| | | | | ± 100 | 10MΩ~100MΩ |
| 2512 | 1W | 200V | 400V | ± 200 | 1Ω~10Ω |
| | | | | ± 100 | 10MΩ~100MΩ |

如有非标准品的需求,请联系我们的业务部门 For non-standard parts, please contact our sales dept.

■性能 (Performance Specifications)

| 内容 Item | 测试方法 Test Methods | 测试条件 Test Conditions | 规格 Specification |
|---|----------------------|---|---|
| 温度系数 Temperature Coefficient | JIS C 5201 4.8 | $TCR = (R - R_0) / (t - t_0) R_0 \times 10^6$ (ppm) R ₀ 电阻在室温下的阻值(resistance at room temperature) R 电阻在 125℃或-55℃下的阻值(resistance at 125℃ or -55℃) t ₀ 室温(room temperature) t 测试温度 (test temperature 125℃ or -55℃) | 0201 规格 : 1Ω ≤ R ≤ 10Ω: ±400 PPM/℃ 10Ω < R ≤ 10MΩ: ±200 PPM/℃ 0402~2512 规格 : 1Ω ≤ R ≤ 10Ω: ±200 PPM/℃ 10Ω < R ≤ 10MΩ: ±100 PPM/℃ 10MΩ < R ≤ 100MΩ: ±200PPM/℃ |
| 短时间过负荷 Short-time overload | JIS C 5201 4.13 | 加载 2.5 倍的额定电压，时间 5 秒后测量试验前后的阻值变化率。 Applied 2.5 times of rated voltage for 5 second. Measure the variation of resistance. | ±(1.00% +0.05Ω) |
| 焊锡性 Solderability | JIS C 5201 4.17 | 沾助焊剂后浸入锡炉，锡炉温度 245±5℃，时间 3±0.5 秒。 Dip the terminal in a flux and then dip into a soldering bath at 245±5℃ for 3±0.5sec. | > 95%面积上锡 (> 95% coverage) |
| 抗焊锡热 Resist to soldering heat | JIS C 5201 4.18 | 沾助焊剂后浸入锡炉，锡炉温度 260±5℃，时间 10±0.5 秒，测量试验前后的阻值变化率。 Dip the terminal in a flux and then dip into a soldering bath at 260±5℃ for 10±0.5sec. Measure the variation of resistance. | ±(1.00% +0.05Ω) |
| 绝缘电阻 Insulation resistance | JIS C 5201 4.6 | 电阻本体上加载绝缘耐压 60±5 秒后，测量绝缘电阻。 Applied the dielectric withstanding voltage on the center of body for 60±5seconds. Then measure insulation resistance. | >10GΩ |
| 绝缘耐压 Dielectric withstanding voltage | JIS C 5201 4.7 | 电阻本体上加载绝缘耐压 60±5 秒。 Applied the dielectric withstanding voltage on the center of body for 60±5seconds. | 无击穿、飞弧及可见机械性损伤 No evidence of flashover, mechanical damage arcing or insulation breakdown |

| 内容 Item | 测试方法 Test Methods | 测试条件 Test Conditions | 规格 Specification |
|--------------------------------|---------------------------|---|---------------------|
| 端子弯曲 Terminalbending | JIS C 5201 4.33 | 电阻焊接在测试板上进行弯折,弯折保持时间 20±1 秒,1206(含) 以下的尺寸弯曲 5+0.2/0 mm; 1206 以上的尺寸弯曲 2+0.2/0 mm; 量测试前后 阻值变化率 Specimen shall be mounted on test board, then bend the board and maintained for 20±1s. the distance of bending is 5+0.2/0 mm for resistors which size no larger than 1206 or 2+0.2/0 mm which size larger than 1206. Measure the variation of resistance. | ±(1.00% +0.05Ω) |
| 温度循环 Temperature Cycling | JIS C 5201 4.19 | 电阻放入温度循环机中,温度 155±2℃至 -55±3℃,共 5 个循环。量测试前后阻值变化率。 Put specimen in a chamber which temperature can be changed to 155±2℃ or -55±3℃, repeated 5 times. Measure the variation of resistance. | ±(2.00% +0.05Ω) |
| 耐湿特性 Humidity | JIS C 5201 4.24 | 电阻放入恒温恒湿箱,温度 40±2℃,湿度 90~95 %RH;通电额定电压 1.5 小时,断电 0.5 小 时;重复通断电至试验时间 1000 ^{+48/-0} 小时。量 测试前后阻值变化率。 Put the specimen in a chamber at 40±2℃ temperature and 90~95% relative humidity, then applied rated voltage for 1.5H and rested for 0.5H repeatedly till total test time is 1000 ^{+48/-0} H. Measure the variation of resistance. | ±(2.00% +0.05Ω) |
| 负荷寿命 Load life | JIS C 5201 4.25.1 | 电阻放入恒温箱中,温度 70±2℃, ON TIME:1.5H ,OFF TIME:0.5H 通电额定电压 1000 ^{+24/-0} 小时,量测试前后阻值变化率。 Put the specimen in a chamber at 70±2℃ temperature, ON TIME:1.5H , OFF TIME:0.5H , and applied rated voltage for 1000 ^{+24/-0} H. Measure the variation of resistance. | ±(2.00% +0.05Ω) |
| 温湿循环 Moisture resistance | MIL-STD-202 METHOD 106 | 25℃~65℃,90~100%RH, 2.5 小时; 65℃ 90~100%RH, 3 小时; 65℃~25℃,80~100%RH,2.5 小时,10 个循环,试 验结束 24±4 小时后进行测试。 25℃~65℃,90~100%RH, 2.5H; 65℃ 90~100%RH, 3H; 65℃~25℃ 80~100%RH, 2.5H, 10 cycles, Measurement at 24±4 hours after test conclusion. | ±(2.00% +0.05Ω) |

高功率厚膜晶片电阻 High Power Thick Chip Resistor FRP Series



应用 (Application)

- Consumerelectrical
- HomeAppliance:Airconditioner,Refrigerato
- Computer & relative products:Mainboard
- Communication equipment:Cell phone,Faxmachine
- Power equipment: Power supply,Illumination equipment
- Measuring instrument: Electric meter, Navigationequipment
- 消费类电子
- 家电：空调，冰箱
- 计算机及相关产品：主板
- 通讯设备：手机、传真机
- 电源设备：电源、照明设备
- 测量仪器：电表、导航设备

特性 (Features)

- Small size and light weight
- Reliability, high quality
- High Power
- 体积小，重量轻
- 可靠性，高质量
- 高功率

料号说明 (Parts Number Explanation) :

示例 Example: FRP1206J102 TS

| F 公司名 | R 产品别 | P 功能别 | 1206 型别 | J 公差 | 102 字码 | T 包装别 | S 端电极 | 特殊型 |
|-----------------|--|---|--|--|---|--|----------------------------|---------------------|
| FOJAN | R:Resistor C:Capacitor L:Inductor D:Diode A:Audion | C:Normal P:Hi-Power L:Lowohmic A:Array S:Surge H:Hi-Precision V:Hi-Voltage Q:Auto-motive R:Anti-sulfur M:Metal D: LED | 0201 0402 0603 0805 1206 1210 2010 2512 | B:±0.1% C:±0.25% D:±0.5% F:±1% J:±5% P : Jumper | ±5%:E24 3-digits+blank 102=1KΩ 1R0=1Ω ±1%&Below : E24+E96 : 4-digits 1001=1KΩ 1R00=1Ω | T: 7 inch reel Q:10 inch reel R:13 inch reel B:Bulk | S : Sn C : Cu A : Au | N:Normal D : LED |
| Company code | Type code | Functional code | Size code | Tolerance code | Resistance code | Packaging code | Termination code | Special code |

■尺寸 (Dimension) :

| 尺寸 dimension |  | | | | |
|-----------------|--|-----------|-----------|-----------|-----------|
| | 单位 (unit) : mm | | | | |
| 型别 (Type) | L | W | H | T1 | T2 |
| 0201 | 0.60±0.03 | 0.30±0.03 | 0.23±0.03 | 0.10±0.05 | 0.15±0.05 |
| 0402 | 1.00±0.05 | 0.50±0.05 | 0.35±0.05 | 0.20±0.10 | 0.25±0.10 |
| 0603 | 1.60±0.10 | 0.80±0.10 | 0.45±0.10 | 0.25±0.15 | 0.25±0.15 |
| 0805 | 2.00±0.10 | 1.25±0.10 | 0.50±0.10 | 0.35±0.20 | 0.35±0.20 |
| 1206 | 3.10±0.10 | 1.60±0.10 | 0.55±0.10 | 0.45±0.20 | 0.40±0.20 |
| 1210 | 3.10±0.10 | 2.60±0.15 | 0.55±0.10 | 0.45±0.15 | 0.50±0.20 |
| 2010 | 5.00±0.10 | 2.50±0.15 | 0.55±0.10 | 0.45±0.15 | 0.50±0.20 |
| 2512 | 6.35±0.10 | 3.10±0.15 | 0.55±0.10 | 0.60±0.20 | 0.50±0.20 |

■电阻结构 (Construction)



| NO. | 结构 construction | 主要材料 Major material |
|-----|--------------------------------|---|
| 1 | 陶瓷基板 Ceramic substrate | 三氧化二铝 Al ₂ O ₃ |
| 2 | 银电极 Conductive layer | 银 Ag |
| 3 | 侧电极 Side conductive layer | 镍铬合金 NiCr |
| 4 | 阻体层 Resistive layer | 氧化钨+玻璃 RuO ₂ + glass |
| 5 | 内保护层 Inner protective layer | 玻璃 Glass |
| 6 | 外保护层 Outer Protective layer | 环氧树脂 Epoxy |
| 7 | 文字 Marking | 环氧树脂 Epoxy |
| 8 | 镍电极 Ni plating layer | 镍 Ni |
| 9 | 锡电极 Sn plating layer | 锡 Matte Tin |

■ 功率衰减曲线 (Derating Curve) :



■ 电气特性 (Electrical characteristics) :

| 型别 Type | 0402 | 0603 | 0805 | 1206 | 1210 | 2010 | 2512 |
|---|-------|-------|-------|-------|-------|-------|-------|
| 绝缘耐压 Dielectric Withstanding Voltage | 100V | 100V | 300V | 500V | 500V | 500V | 500V |
| 零欧姆阻值 ±5% Resistance Value of Jumper ±5% | <50mΩ | <50mΩ | <50mΩ | <50mΩ | <50mΩ | <50mΩ | <50mΩ |
| 零欧姆额定电流 Rated Current of Jumper | 1A | 1A | 2A | 2A | 2A | 2A | 2A |
| 零欧姆电阻最大电流 Max Current of Jumper | 3A | 4A | 6A | 10A | 12A | 12A | 12A |

■ 电性规格 (Standard Electrical Specifications)

| 型别 Type | 额定功率 (Power Rating at 70°C) | 最高工作电压 Max. RCWV | 最大过负荷电压 Max. Overload Voltage | T.C.R. (PPM/°C) | 阻值范围 Resistance Range |
|---------|----------------------------------|---------------------|----------------------------------|--------------------|--------------------------|
| 0402 | 1/10W | 50V | 100V | ±200 | 1Ω~10MΩ |
| 0603 | 1/5W | 75V | 150V | | |
| 0805 | 1/4W | 150V | 300V | | |
| 1206 | 1/2W | 200V | 400V | | |
| 1210 | 3/4W | 200V | 500V | | |
| 2010 | 1W | 200V | 500V | | |
| 2512 | 2W | 200V | 500V | | |

如有非标准品的需求,请联系我们的业务部门 For non-standard parts, please contact our sales dept.

■性能 (Performance Specifications) :

| 内容 Item | 测试方法 Test Methods | 测试条件 Test Conditions | 规格 Specification |
|---|----------------------|--|--|
| 温度系数 Temperature Coefficient | JIS C 5201 4.8 | $TCR = (R - R_0) / (t - t_0) R_0 \times 10^6$ (ppm) R ₀ 电阻在室温下的阻值(resistance at room temperature) R 电阻在 125℃或-55℃下的阻值(resistance at 125℃ or -55℃) t ₀ 室温(room temperature) t 测试温度 (test temperature 125℃ or -55℃) | 1Ω-10MΩ<R≦22MΩ: ±200 PPM/℃ |
| 短时间过负荷 Short-time overload | JIS C 5201 4.13 | 加载 2.5 倍的额定电压, 时间 5 秒后测量试验前后的阻值变化率。 Applied 2.5 times of rated voltage for 5 second. Measure the variation of resistance. | ±(1.00% +0.05Ω) |
| 焊锡性 Solderability | JIS C 5201 4.17 | 沾助焊剂后浸入锡炉, 锡炉温度 245±5℃, 时间 3±0.5 秒。 Dip the terminal in a flux and then dip into a soldering bath at 245±5℃ for 3±0.5sec. | > 95%面积上锡 (> 95% coverage) |
| 抗焊锡热 Resist to soldering heat | JIS C 5201 4.18 | 沾助焊剂后浸入锡炉, 锡炉温度 260±5℃, 时间 10±0.5 秒, 测量试验前后的阻值变化率。 Dip the terminal in a flux and then dip into a soldering bath at 260±5℃ for 10±0.5sec. Measure the variation of resistance. | ±(1.00% +0.05Ω) |
| 绝缘电阻 Insulation resistance | JIS C 5201 4.6 | 电阻本体上加载绝缘耐压 60±5 秒后, 测量绝缘阻抗。 Applied the dielectric withstanding voltage on the center of body for 60±5seconds. Then measure insulation resistance. | >10GΩ |
| 绝缘耐压 Dielectric withstanding voltage | JIS C 5201 4.7 | 电阻本体上加载绝缘耐压 60±5 秒。 Applied the dielectric withstanding voltage on the center of body for60±5seconds. | 无击穿、飞弧及可见机械性损伤 No evidence of flashover, mechanical damage arcing or insulation breakdown |
| 端子弯曲 Terminal bending | JIS C 5201 4.33 | 电阻焊接在测试板上进行弯折, 弯折保持时间 20±1 秒, 1206(含) 以下的尺寸弯曲 5+0.2/0mm; 1206 以上的尺寸弯曲 2+0.2/0 mm; 量测试验前后阻值变化率 Specimen shall be mounted on test board, then bend the board and maintained for 20±1s. the distance of bending is 5+0.2/0 mm for resistors which size no larger than 1206 or 2+0.2/0 mm which size larger than 1206. Measure the variation of resistance. | ±(1.00% +0.05Ω) |

| 内容 Item | 测试方法 Test Methods | 测试条件 Test Conditions | 规格 Specification |
|--------------------------------|---------------------------|--|----------------------------|
| 温度循环 Temperature Cycling | JIS C 5201 4.19 | 电阻放入温度循环机中，温度 $155\pm 2^{\circ}\text{C}$ 至 $-55\pm 3^{\circ}\text{C}$ ，共 5 个循环。量测试验前后阻值变化率。 Put specimen in a chamber which temperature can be changed to $155\pm 2^{\circ}\text{C}$ or $-55\pm 3^{\circ}\text{C}$, repeated 5 times. Measure the variation of resistance. | $\pm(2.00\% + 0.05\Omega)$ |
| 耐湿特性 Humidity | JIS C 5201 4.24 | 电阻放入恒温恒湿箱，温度 $40\pm 2^{\circ}\text{C}$ ，湿度 90~95 %RH;通电额定电压 1.5 小时，断电 0.5 小时；重复通断电至试验时间 $1000^{+48}/_{-0}$ 小时。量测试验前后阻值变化率。 Put the specimen in a chamber at $40\pm 2^{\circ}\text{C}$ temperature and 90~95% relative humidity, then applied rated voltage for 1.5H and rested for 0.5H repeatedly till total test time is $1000^{+48}/_{-0}$ H. Measure the variation of resistance. | $\pm(2.00\% + 0.05\Omega)$ |
| 负荷寿命 Load life | JIS C 5201 4.25.1 | 电阻放入恒温箱中，温度 $70\pm 2^{\circ}\text{C}$ ，ON TIME:1.5H，OFF TIME:0.5H，通电额定电压 $1000^{+24}/_{-0}$ 小时，量测试验前后阻值变化率。 Put the specimen in a chamber at $70\pm 2^{\circ}\text{C}$ temperature, ON TIME:1.5H，OFF TIME:0.5H，and applied rated voltage for $1000^{+24}/_{-0}$ H. Measure the variation of resistance. | $\pm(2.00\% + 0.05\Omega)$ |
| 温湿循环 Moisture resistance | MIL-STD-202 METHOD 106 | 25°C~65°C,90~100%RH, 2.5 小时; 65°C 90~100%RH, 3 小时; 65°C~25°C,80~100%RH,2.5 小时,10 个循环,试验结束 24±4 小时后进行测试。 25°C~65°C,90~100%RH, 2.5H; 65°C 90~100%RH, 3H; 65°C~25°C 80~100%RH, 2.5H, 10 cycles, Measurement at 24±4 hours after test conclusion. | $\pm(2.00\% + 0.05\Omega)$ |

高压厚膜晶片电阻 High Voltage Thick Film Chip Resistor FRV Series



应用(Application)

- Powersupply,Industrialcontrolsystem
- Measurementinstrument
- Back lightinverter
- Medical, Precisionequipments
- 电源、工控系统
- 测量仪器
- 背光逆变器
- 医疗、精密设备

特性(Features)

- Small size and light weight
- Reliability, high quality
- Specialmaterialanddesignforhighworkingvoltage require
- 体积小，重量轻
- 可靠性，高质量
- 对高工作电压要求的特殊材质和设计

料号说明(Parts Number Explanation) :

示例 Example: FRV1206J103 TS

| E 公司名 | R 产品别 | V 功能别 | 1206 型别 | J 公差 | 103 字码 | I 包装别 | S 端电极 | 特殊型 |
|-----------------|--|--|--|--|---|--|----------------------------|---------------------|
| FOJAN | R:Resistor C:Capacitor L:Inductor D:Diode A:Audion | C:Normal P:Hi-Power L:Lowohmic A:Array S:Surge H:Hi-Precision V:Hi-Voltage Q:Auto-motive R:Anti-sulfur M:Metal D:(LED) | 0603 0805 1206 1210 2010 2512 | B:±0.1% C:±0.25% D:±0.5% F:±1% J:±5% P : Jumper | ±5%:E24 3-digits+blank 102=1KΩ 1R0=1Ω ±1%&Below : E24+E96 : 4-digits 1001=1KΩ 1R00=1Ω | T: 7 inch reel Q:10 inch reel R:13 inch reel B:Bulk | S : Sn C : Cu A : Au | N:Normal D : LED |
| Company code | Type code | Functional code | Size code | Tolerance code | Resistance code | Packaging code | Termination code | Special code |

■尺寸 (Dimension)

| 尺寸 dimension |  | | | | |
|-----------------|--|-----------|-----------|-----------|-----------|
| | 单位 (unit) : mm | | | | |
| 型别 (Type) | L | W | H | T1 | T2 |
| 0603 | 1.60±0.10 | 0.80±0.10 | 0.45±0.10 | 0.25±0.15 | 0.25±0.15 |
| 0805 | 2.00±0.10 | 1.25±0.10 | 0.50±0.10 | 0.35±0.20 | 0.35±0.20 |
| 1206 | 3.10±0.10 | 1.60±0.10 | 0.55±0.10 | 0.45±0.20 | 0.40±0.20 |
| 1210 | 3.10±0.10 | 2.60±0.15 | 0.55±0.10 | 0.45±0.15 | 0.50±0.20 |
| 2010 | 5.00±0.10 | 2.50±0.15 | 0.55±0.10 | 0.45±0.15 | 0.50±0.20 |
| 2512 | 6.35±0.10 | 3.10±0.15 | 0.55±0.10 | 0.60±0.20 | 0.50±0.20 |

■电阻结构 (Construction)



| NO. | 结构 construction | 主要材料 Major material |
|-----|--------------------------------|---|
| 1 | 陶瓷基板 Ceramic substrate | 三氧化二铝 Al ₂ O ₃ |
| 2 | 银电极 Conductive layer | 银 Ag |
| 3 | 侧电极 Side conductive layer | 镍铬合金 NiCr |
| 4 | 阻体层 Resistive layer | 氧化钌+玻璃 RuO ₂ + glass |
| 5 | 内保护层 Inner protective layer | 玻璃 Glass |
| 6 | 外保护层 Outer Protective layer | 环氧树脂 Epoxy |
| 7 | 文字 Marking | 环氧树脂 Epoxy |
| 8 | 镍电极 Ni plating layer | 镍 Ni |
| 9 | 锡电极 Sn plating layer | 锡 Matte Tin |

■功率衰减曲线 (Derating Curve)



■电气特性 (Electrical characteristics)

| 型别 Type | 0603 | 0805 | 1206 | 1210 | 2010 | 2512 |
|---|-------|-------|-------|--------|-------|-------|
| 绝缘耐压 Dielectric Withstanding Voltage | 100V | 300V | 500V | 500V | 500V | 500V |
| 零欧姆阻值 ±5% Resistance Value of Jumper ±5% | <50mΩ | <50mΩ | <50mΩ | <50m Ω | <50mΩ | <50mΩ |
| 零欧姆额定电流 Rated Current of Jumper | 1A | 2A | 2A | 2A | 2A | 2A |
| 零欧姆电阻最大电流 Max Current of Jumper | 2A | 5A | 10A | 10A | 10A | 10A |

■电性规格 (Standard Electrical Specifications)

| 型别 Type | 额定功率 (Power Rating at 70°C) | 最高工作电压 Max. RCWV | 最大过负荷电压 Max. Overload Voltage | T.C.R. (PPM/°C) | 阻值范围 Resistance Range |
|---------|----------------------------------|---------------------|----------------------------------|--------------------|--------------------------|
| 0603 | 1/10W | 350V | 500V | ±200PPM/°C | 47Ω~10MΩ |
| 0805 | 1/8W | 400V | 800V | | |
| 1206 | 1/4W | 500V | 1000V | | |
| 1210 | 1/3W | 500V | 1000V | | |
| 2010 | 3/4W | 500V | 1000V | | |
| 2512 | 1W | 500V | 1000V | | |

如有非标准品的需求,请联系我们的业务部门 For non-standard parts, please contact our sales dept.

■性能 (Performance Specifications)

| 内容 Item | 测试方法 Test Methods | 测试条件 Test Conditions | 规格 Specification |
|---|----------------------|--|--|
| 温度系数 Temperature Coefficient | JIS C 5201 4.8 | $TCR = (R - R_0) / (t - t_0) R_0 \times 10^6$ (ppm) R_0 电阻在室温下的阻值(resistance at room temperature) R 电阻在 125℃或-55℃下的阻值 (resistance at 125℃ or -55℃) t_0 室温(room temperature) t 测试温度 (test temperature 125℃ or -55℃) | $47\Omega < R \leq 10M\Omega$: ± 200 PPM/℃ |
| 短时间过负荷 Short-time overload | JIS C 5201 4.13 | 加载 2.5 倍的额定电压 ,时间 5 秒后测量试验前后的阻值变化率。 Applied 2.5 times of rated voltage for 5 second. Measure the variation of resistance. | $\pm(1.00\% + 0.05\Omega)$ |
| 焊锡性 Solderability | JIS C 5201 4.17 | 沾助焊剂后浸入锡炉, 锡炉温度 $245 \pm 5^\circ\text{C}$, 时间 3 ± 0.5 秒。 Dip the terminal in a flux and then dip into a soldering bath at $245 \pm 5^\circ\text{C}$ for $3 \pm 0.5\text{sec}$. | $> 95\%$ 面积上锡 (> 95% coverage) |
| 抗焊锡热 Resist to soldering heat | JIS C 5201 4.18 | 沾助焊剂后浸入锡炉, 锡炉温度 $260 \pm 5^\circ\text{C}$, 时间 10 ± 0.5 秒, 测量试验前后的阻值变化率。 Dip the terminal in a flux and then dip into a soldering bath at $260 \pm 5^\circ\text{C}$ for $10 \pm 0.5\text{sec}$. Measure the variation of resistance. | $\pm(1.00\% + 0.05\Omega)$ |
| 绝缘电阻 Insulation resistance | JIS C 5201 4.6 | 电阻本体上加载绝缘耐压 60 ± 5 秒后, 测量绝缘阻抗。 Applied the dielectric withstanding voltage on the center of body for $60 \pm 5\text{seconds}$. Then measure insulation resistance. | $> 10G\Omega$ |
| 绝缘耐压 Dielectric withstanding voltage | JIS C 5201 4.7 | 电阻本体上加载绝缘耐压 60 ± 5 秒。 Applied the dielectric withstanding voltage on the center of body for $60 \pm 5\text{seconds}$. | 无击穿、飞弧及可见机械性损伤 No evidence of flashover, mechanical damage arcing or insulation breakdown |

| 内容 Item | 测试方法 Test Methods | 测试条件 Test Conditions | 规格 Specification |
|-----------------------------|------------------------|--|---------------------|
| 端子弯曲 Terminal bending | JIS C 5201 4.33 | 电阻焊接在测试板上进行弯折,弯折保持时间 20±1 秒, 1206(含) 以下的尺寸弯曲 5+0.2/0 mm; 1206 以上的尺寸弯曲 2+0.2/0 mm; 量测试验前后阻值变化率 Specimen shall be mounted on test board, then bend the board and maintained for 20±1s. the distance of bending is 5+0.2/0 mm for resistors which size no larger than 1206 or 2+0.2/0 mm which size larger than 1206. Measure the variation of resistance. | ±(1.00% +0.05Ω) |
| 温度循环 Temperature Cycling | JIS C 5201 4.19 | 电阻放入温度循环机中,温度 155±2℃ 至-55±3℃, 共 5 个循环。量测试验前后阻值变化率。 Put specimen in a chamber which temperature can be changed to 155±2℃ or -55±3℃, repeated 5 times. Measure the variation of resistance. | ±(2.00% +0.05Ω) |
| 耐湿特性 Humidity | JIS C 5201 4.24 | 电阻放入恒温恒湿箱, 温度 40±2℃, 湿度 90~95 %RH;通电额定电压 1.5 小时, 断电 0.5 小时;重复通断电至试验时间 1000 ^{+48/-0} 小时。量测试验前后阻值变化率。 Put the specimen in a chamber at 40±2℃ temperature and 90~95% relative humidity, then applied rated voltage for 1.5H and rested for 0.5H repeatedly till total test time is 1000 ^{+48/-0} H. Measure the variation of resistance. | ±(2.00% +0.05Ω) |
| 负荷寿命 Load life | JIS C 5201 4.25.1 | 电阻放入恒温箱中,温度 70±2℃, ON TIME:1.5H, OFF TIME:0.5H, 通电额定电压 1000 ^{+24/-0} 小时,量测试验前后阻值变化率。 Put the specimen in a chamber at 70±2℃ temperature, ON TIME:1.5H, OFF TIME:0.5H, and applied rated voltage for 1000 ^{+24/-0} H. Measure the variation of resistance. | ±(2.00% +0.05Ω) |
| 温湿循环 Moisture resistance | MIL-STD-202 METHOD 106 | 25℃~65℃,90~100%RH, 2.5 小时; 65℃ 90~100%RH, 3 小时; 65℃~25℃,80~100%RH,2.5 小时,10 个循环,试验结束 24±4 小时后进行测试。 25℃~65℃,90~100%RH, 2.5H; 65℃ 90~100%RH, 3H; 65℃~25℃ 80~100%RH, 2.5H, 10 cycles, Measurement at 24±4 hours after test conclusion. | ±(2.00% +0.05Ω) |

低阻厚膜晶片电阻
Low Resistance Thick Chip Resistor
FRL series



■应用 (Application)

- Entertainment : Stereo , TV tuners , Tape recorder
- Appliance: Air conditioner, Refrigerator
- Computer & relative products : Main board, PDA
- Communication equipment: Cell phone, Fax machine
- Power equipment: Power supply , II Lumination equipment
- Measuring instrument: Electric meter, Navigation equipment

- 娱乐：立体声，电视调谐器，录音机
- 电器：空调、冰箱
- 电脑及相关产品：主板、掌上电脑
- 通讯设备：手机、传真机
- 电源设备：电源、二级照明设备
- 测量仪器：电表、导航设备

■特点 (Features)

- Small size and light weight
- Reliability, high quality
- Low Resistance & Suitable for Large Current Application
- Ultra-low Value

- 体积小，重量轻
- 可靠性，高质量
- 低阻值，适合大电流通过
- 超低阻值

■料号说明 (Parts Number Explanation) :

示例 Example: FRL1206JR470 TS

| <u>F</u> 公司名 | <u>R</u> 产品别 | <u>L</u> 功能别 | <u>1206</u> 型别 | <u>F</u> 公差 | <u>R470</u> 字码 | <u>I</u> 包装别 | <u>S</u> 端电极 | 特殊型 |
|-----------------|--|---|--|--|--|--|----------------------------|---------------------|
| FOJAN | R:Resistor C:Capacitor L:Inductor D:Diode A:Audion | C:Normal P:Hi-Power L:Lowohmic A:Array S:Surge H:Hi-Precision V:Hi-Voltage Q:Auto-motive R:Anti-sulfur M:Metal D: LED | 0402 0603 0805 1206 1210 2010 1812 2512 | B:±0.1% C:±0.25% D:±0.5% F:±1% J:±5% P : Jumper | 0603:E24/E96 3-digits+blank R10=100mR R91=910mR 02Z=102mR Others type: E24/E96 4-digits R100=100mR R102=102mR R910=910mR | T: 7 inch reel Q:10 inch reel R:13 inch reel B:Bulk | S : Sn C : Cu A : Au | N:Normal D : LED |
| Company code | Type code | Functional code | Size code | Tolerance code | Resistance code | Packaging code | Termination code | Special code |

■尺寸 (Dimension)

| 尺寸 dimension |  | | | | |
|-----------------|--|-----------|-----------|-----------|-----------|
| | 单位 (unit) : mm | | | | |
| 型别 (Type) | L | W | H | T1 | T2 |
| 0402 | 1.00±0.05 | 0.50±0.05 | 0.35±0.05 | 0.20±0.10 | 0.25±0.10 |
| 0603 | 1.60±0.10 | 0.80±0.10 | 0.45±0.10 | 0.25±0.15 | 0.25±0.15 |
| 0805 | 2.00±0.10 | 1.25±0.10 | 0.50±0.10 | 0.35±0.20 | 0.35±0.20 |
| 1206 | 3.10±0.10 | 1.60±0.10 | 0.55±0.10 | 0.45±0.20 | 0.40±0.20 |
| 1210 | 3.10±0.10 | 2.60±0.15 | 0.55±0.10 | 0.45±0.15 | 0.50±0.20 |
| 2010 | 5.00±0.10 | 2.50±0.15 | 0.55±0.10 | 0.45±0.15 | 0.50±0.20 |
| 1812 | 4.50±0.20 | 3.10±0.20 | 0.55±0.10 | 0.55±0.20 | 0.70±0.20 |
| 2512 | 6.35±0.10 | 3.10±0.15 | 0.55±0.10 | 0.60±0.20 | 0.50±0.20 |

■电阻结构 (Construction)



| NO. | 结构 construction | 主要材料 Major material |
|-----|--------------------------------|---|
| 1 | 陶瓷基板 Ceramic substrate | 三氧化二铝 Al ₂ O ₃ |
| 2 | 银电极 Conductive layer | 银 Ag |
| 3 | 侧电极 Side conductive layer | 镍铬合金 NiCr |
| 4 | 阻体层 Resistive layer | 氧化钌+玻璃 RuO ₂ + glass |
| 5 | 内保护层 Inner protective layer | 玻璃 Glass |
| 6 | 外保护层 Outer Protective layer | 环氧树脂 Epoxy |
| 7 | 文字 Marking | 环氧树脂 Epoxy |
| 8 | 镍电极 Ni plating layer | 镍 Ni |
| 9 | 锡电极 Sn plating layer | 锡 Matte Tin |

■功率衰减曲线 (Derating Curve)



■电气特性 (Electrical characteristics)

| 型别 Type | 额定功率 (Power Rating at 70°C) | 绝缘耐压 Dielectric Withstanding Voltage | 额定电流 Rated Current of Jumper | 最大电流 Max Current of Jumper | T.C.R. (PPM/°C) | 阻值范围 Resistance Range |
|------------|----------------------------------|---|---------------------------------|-------------------------------|-------------------------------|--------------------------|
| 0402 | 1/16W | 100V | 0.79A | 1.97A | 0.02Ω~0.06(含): ±1200PPM/°C | 0R1~1Ω |
| 0603 | 1/10W | 100V | 2.23A | 5.59A | | |
| 0805 | 1/8W | 300V | 2.5A | 6.25A | 0.06Ω~0.2(含): ±600PPM/°C | 0R01~1Ω |
| 1206 | 1/4W | 500V | 3.53A | 8.83A | | |
| 1210 | 1/3W | 500V | 5A | 12.50A | 0.2Ω~0.5(含): ±300PPM/°C | |
| 2010 | 3/4W | 500V | 6.12A | 15.30A | | |
| 2512 | 1W | 500V | 7.07A | 17.67A | >0.5Ω:±200PPM/°C | |

如有非标准品的需求,请联系我们的业务部门 For non-standard parts, please contact our sales dept.

■性能 (Performance Specifications)

| 内容 Item | 测试方法 Test Methods | 测试条件 Test Conditions | 规格 Specification |
|-------------------------------------|----------------------|---|--|
| 温度系数 Temperature Coefficient | JIS C 5201 4.8 | $TCR = (R - R_0) / (t - t_0) R_0 \times 10^6$ (ppm) R_0 电阻在室温下的阻值(resistance at room temperature) R 电阻在 125℃或-55℃下的阻值 (resistance at 125℃ or -55℃) t_0 室温(room temperature) t 测试温度 (test temperature 125℃ or -55℃) | 0.02Ω~0.06(含): ±1200PPM/℃ 0.06Ω~0.2(含): ±600PPM/℃ 0.2Ω~0.5(含): ±300PPM/℃ >0.5Ω: ±200PPM/℃ |
| 短时间过负荷 Short-time overload | JIS C 5201 4.13 | 加载 2.5 倍的额定电压，时间 5 秒后测量 试验前后的阻值变化率。 Applied 2.5 times of rated voltage for 5 second. Measure the variation of resistance. | ±(1.00% +0.05Ω) |
| 焊锡性 Solderability | JIS C 5201 4.17 | 沾助焊剂后浸入锡炉，锡炉温度 245±5℃， 时间 3±0.5 秒。 Dip the terminal in a flux and then dip into a soldering bath at 245±5℃ for 3±0.5sec. | > 95%面积上锡 (> 95% coverage) |
| 抗焊锡热 Resist to soldering heat | JIS C 5201 4.18 | 沾助焊剂后浸入锡炉，锡炉温度 260±5℃， 时间 10±0.5 秒，测量试验前后的阻值变 化率。 Dip the terminal in a flux and then dip into a soldering bath at 260±5℃ for 10±0.5sec. Measure the variation of resistance. | ±(1.00% +0.05Ω) |

| 内容 Item | 测试方法 Test Methods | 测试条件 Test Conditions | 规格 Specification |
|---|----------------------|---|--|
| 绝缘电阻 Insulation resistance | JIS C 5201 4.6 | 电阻本体上加载绝缘耐压 60±5 秒后，测量绝缘阻抗。 Applied the dielectric withstanding voltage on the center of body for 60±5seconds. Then measure insulation resistance. | >10GΩ |
| 绝缘耐压 Dielectric withstanding voltage | JIS C 5201 4.7 | 电阻本体上加载绝缘耐压 60±5 秒。 Applied the dielectric withstanding voltage on the center of body for 60±5seconds. | 无击穿、飞弧及可见机械性损伤 No evidence of flashover, mechanical damage arcing or insulation breakdown |
| 端子弯曲 Terminal bending | JIS C 5201 4.33 | 电阻焊接在测试板上进行弯折,弯折保持时间 20±1 秒,1206(含) 以下的尺寸弯曲 5+0.2/0 mm; 1206 以上的尺寸弯曲 2+0.2/0 mm; 量测试验前后阻值变化率 Specimen shall be mounted on test board, then bend the board and maintained for 20±1s. the distance of bending is 5+0.2/0 mm for resistors which size no larger than 1206 or 2+0.2/0 mm which size larger than 1206. Measure the variation of resistance. | ±(1.00% +0.05Ω) |
| 温度循环 Temperature Cycling | JIS C 5201 4.19 | 电阻放入温度循环机中,温度 155±2℃至 -55±3℃, 共 5 个循环。量测试验前后阻值变化率。 Put specimen in a chamber which temperature can be changed to 155±2℃ or -55±3℃, repeated 5 times. Measure the variation of resistance. | ±(2.00% +0.05Ω) |

| 内容 Item | 测试方法 Test Methods | 测试条件 Test Conditions | 规格 Specification |
|-----------------------------|------------------------|--|---------------------------|
| 耐湿特性 Humidity | JIS C 5201 4.24 | <p>电阻放入恒温恒湿箱，温度 $40\pm 2^{\circ}\text{C}$，湿度 90~95 %RH;通电额定电压 1.5 小时，断电 0.5 小时；重复通断电至试验时间 $1000^{+48}/_{-0}$ 小时。量测试验前后阻值变化率。</p> <p>Put the specimen in a chamber at $40\pm 2^{\circ}\text{C}$ temperature and 90~95% relative humidity, then applied rated voltage for 1.5H and rested for 0.5H repeatedly till total test time is $1000^{+48}/_{-0}$ H. Measure the variation of resistance.</p> | $\pm(2.00\% +0.05\Omega)$ |
| 负荷寿命 Load life | JIS C 5201 4.25.1 | <p>电阻放入恒温箱中，温度 $70\pm 2^{\circ}\text{C}$，ON TIME:1.5H，OFF TIME:0.5H，通电额定电压 $1000^{+24}/_{-0}$ 小时，量测试验前后阻值变化率。</p> <p>Put the specimen in a chamber at $70\pm 2^{\circ}\text{C}$ temperature, ON TIME:1.5H，OFF TIME:0.5H，and applied rated voltage for $1000^{+24}/_{-0}$H. Measure the variation of resistance.</p> | $\pm(2.00\% +0.05\Omega)$ |
| 温湿循环 Moisture resistance | MIL-STD-202 METHOD 106 | <p>$25^{\circ}\text{C}\sim 65^{\circ}\text{C}$,90~100%RH, 2.5 小时; 65°C 90~100%RH, 3 小时;</p> <p>$65^{\circ}\text{C}\sim 25^{\circ}\text{C}$,80~100%RH,2.5 小时,10 个循环,试验结束 24 ± 4 小时后进行测试。</p> <p>$25^{\circ}\text{C}\sim 65^{\circ}\text{C}$,90~100%RH, 2.5H; 65°C 90~100%RH, 3H; $65^{\circ}\text{C}\sim 25^{\circ}\text{C}$ 80~100%RH, 2.5H, 10 cycles, Measurement at 24 ± 4 hours after test conclusion.</p> | $\pm(2.00\% +0.05\Omega)$ |

LED 厚膜晶片电阻
Thick Chip Resistor Product FOR LED
FRD Series



■应用 (Application)

- Soft Circuit board
- Soft lamp circuit
- 软性电路板
- 软灯条电路

■特性 (Features)

- Small size and light weight
- Reliability, high quality
- Stenghtened terminals &Suitable for Special Flexible PCB
- 体积小, 重量轻
- 可靠性, 高质量
- 电极强化, 更符合柔性线路板应用

■料号说明 (Parts Number Explanation)

示例 Example: FRD1206J331 TS

| E 公司名 | R 产品别 | D 功能别 | 1206 型别 | J 公差 | 331 字码 | I 包装别 | S 端电极 | 特殊型 |
|-----------------|-----------------|-----------------|-------------------|--|---|--|----------------------------|---------------------|
| FOJAN | R:Resistor | D: LED | 0805 1206 | B:±0.1% C:±0.25% D:±0.5% F:±1% J:±5% P : Jumper | ±5%:E24 3-digits+blank 102=1KΩ 1R0=1Ω ±1%&Below : E24+E96 : 4-digits 1001=1KΩ 1R00=1Ω | T: 7 inch reel Q:10 inch reel R:13 inch reel B:Bulk | S : Sn C : Cu A : Au | N:Normal D : LED |
| Company code | Type code | Functional code | Size code | Tolerance code | Resistance code | Packaging code | Termination code | Special code |

■尺寸 (Dimension)

| | | | | | | |
|-----------------|--|-----------|-----------|-----------|-----------|----------------|
| 尺寸 dimension |  | | | | | 单位 (unit) : mm |
| | 型别 (Type) | L | W | H | T1 | |
| 0805 | 2.00±0.10 | 1.25±0.10 | 0.50±0.10 | 0.35±0.20 | 0.40±0.20 | |
| 1206 | 3.10±0.10 | 1.60±0.10 | 0.55±0.10 | 0.45±0.20 | 0.45±0.20 | |

■功率衰减曲线 (Derating Curve)



■电气特性 (Electrical characteristics)

| 型别 Type | 0805 | 1206 |
|---|-------|-------|
| 绝缘耐压 Dielectric Withstanding Voltage | 300V | 500V |
| 零欧姆阻值 ±1% Resistance Value of Jumper ±1% | <30mΩ | <30mΩ |
| 零欧姆阻值 ±5% Resistance Value of Jumper ±5% | <50mΩ | <50mΩ |
| 零欧姆额定电流 Rated Current of Jumper | 2A | 2A |
| 零欧姆电阻最大电流 Max Current of Jumper | 5A | 10A |

■电性规格 (Standard Electrical Specifications)

| 型别 Type | 额定功率 (Power Rating at 70°C) | 最高工作电压 Max. RCWV | 最大过负荷电压 Max. Overload Voltage | T.C.R. (PPM/°C) | 阻值范围 Resistance Range |
|------------|----------------------------------|---------------------|----------------------------------|--------------------|--------------------------|
| 0805 | 1/8W | 150V | 300V | ± 400 | 1Ω~10Ω |
| | | | | ± 200 | 10 MΩ~22 MΩ |
| | | | | ± 100 | 10Ω~10MΩ |
| 1206 | 1/4W | 200V | 400V | ± 400 | 1Ω~10Ω |
| | | | | ± 200 | 10 MΩ~22 MΩ |
| | | | | ± 100 | 10Ω~10MΩ |

如有非标准品的需求,请联系我们的业务部门 For non-standard parts, please contact our sales dept.

■性能 (Performance Specifications)

| 内容 Item | 测试方法 Test Methods | 测试条件 Test Conditions | 规格 Specification |
|---------------------------------|----------------------|---|---|
| 温度系数 Temperature Coefficient | JIS C 5201 4.8 | $TCR = (R - R_0) / (t - t_0) R_0 \times 10^6$ (ppm) R_0 电阻在室温下的阻值(resistance at room temperature) R 电阻在 125°C或-55°C下的阻值(resistance at 125°C or -55°C) t_0 室温(room temperature) t 测试温度 (test temperature 125°C or -55°C) | $1\Omega \leq R \leq 10\Omega$: ±400 PPM/°C $10\text{ M}\Omega \sim 22\text{ M}\Omega$ ±200 PPM/°C $10\Omega < R \leq 10\text{M}\Omega$: ±100 PPM/°C |

| 内容 Item | 测试方法 Test Methods | 测试条件 Test Conditions | 规格 Specification |
|---|----------------------|---|--|
| 短时间过负荷 Short-time overload | JIS C 5201 4.13 | 加载 2.5 倍的额定电压，时间 5 秒后测量试验前后的阻值变化率。 Applied 2.5 times of rated voltage for 5 second. Measure the variation of resistance. | $\pm(1.00\% + 0.05\Omega)$ |
| 焊锡性 Solderability | JIS C 5201 4.17 | 沾助焊剂后浸入锡炉，锡炉温度 $245\pm 5^{\circ}\text{C}$ ，时间 3 ± 0.5 秒。 Dip the terminal in a flux and then dip into a soldering bath at $245\pm 5^{\circ}\text{C}$ for $3\pm 0.5\text{sec}$. | > 95%面积上锡 (> 95% coverage) |
| 抗焊锡热 Resist to soldering heat | JIS C 5201 4.18 | 沾助焊剂后浸入锡炉，锡炉温度 $260\pm 5^{\circ}\text{C}$ ，时间 10 ± 0.5 秒，测量试验前后的阻值变化率。 Dip the terminal in a flux and then dip into a soldering bath at $260\pm 5^{\circ}\text{C}$ for $10\pm 0.5\text{sec}$. Measure the variation of resistance. | $\pm(1.00\% + 0.05\Omega)$ |
| 绝缘电阻 Insulation resistance | JIS C 5201 4.6 | 电阻本体上加载绝缘耐压 60 ± 5 秒后，测量绝缘阻抗。 Applied the dielectric withstanding voltage on the center of body for $60\pm 5\text{seconds}$. Then measure insulation resistance. | >10G Ω |
| 绝缘耐压 Dielectric withstanding voltage | JIS C 5201 4.7 | 电阻本体上加载绝缘耐压 60 ± 5 秒。 Applied the dielectric withstanding voltage on the center of body for $60\pm 5\text{seconds}$. | 无击穿、飞弧及可见机械性损伤 No evidence of flashover, mechanical damage arcing or insulation breakdown |
| 端子弯曲 Terminal bending | JIS C 5201 4.33 | 电阻焊接在测试板上进行弯折，弯折保持时间 20 ± 1 秒，1206(含) 以下的尺寸弯曲 $5+0.2/0$ mm; 1206 以上的尺寸弯曲 $2+0.2/0$ mm; 量测试验前后阻值变化率 Specimen shall be mounted on test board, then bend the board and maintained for $20\pm 1\text{s}$. the distance of bending is $5+0.2/0$ mm for resistors which size no larger than 1206 or $2+0.2/0$ mm which size larger than 1206. Measure the variation of resistance. | $\pm(1.00\% + 0.05\Omega)$ |

| 内容 Item | 测试方法 Test Methods | 测试条件 Test Conditions | 规格 Specification |
|--------------------------------|------------------------|--|----------------------------|
| 温度循环 Temperature Cycling | JIS C 5201 4.19 | 电阻放入温度循环机中，温度 $155\pm 2^{\circ}\text{C}$ 至 $-55\pm 3^{\circ}\text{C}$ ，共 5 个循环。量测试验前后阻值变化率。 Put specimen in a chamber which temperature can be changed to $155\pm 2^{\circ}\text{C}$ or $-55\pm 3^{\circ}\text{C}$, repeated 5 times. Measure the variation of resistance. | $\pm(2.00\% + 0.05\Omega)$ |
| 耐湿特性 Humidity | JIS C 5201 4.24 | 电阻放入恒温恒湿箱，温度 $40\pm 2^{\circ}\text{C}$ ，湿度 90~95 %RH；通电额定电压 1.5 小时，断电 0.5 小时；重复通断电至试验时间 $1000^{+48}/_{-0}$ 小时。量测试验前后阻值变化率。 Put the specimen in a chamber at $40\pm 2^{\circ}\text{C}$ temperature and 90~95% relative humidity, then applied rated voltage for 1.5H and rested for 0.5H repeatedly till total test time is $1000^{+48}/_{-0}$ H. Measure the variation of resistance. | $\pm(2.00\% + 0.05\Omega)$ |
| 负荷寿命 Load life | JIS C 5201 4.25.1 | 电阻放入恒温箱中，温度 $70\pm 2^{\circ}\text{C}$ ，ON TIME:1.5H，OFF TIME:0.5H，通电额定电压 $1000^{+24}/_{-0}$ 小时，量测试验前后阻值变化率。 Put the specimen in a chamber at $70\pm 2^{\circ}\text{C}$ temperature, ON TIME:1.5H，OFF TIME:0.5H，and applied rated voltage for $1000^{+24}/_{-0}$ H. Measure the variation of resistance. | $\pm(2.00\% + 0.05\Omega)$ |
| 温湿循环 Moisture resistance | MIL-STD-202 METHOD 106 | 25°C~65°C,90~100%RH, 2.5 小时; 65°C 90~100%RH, 3 小时; 65°C~25°C,80~100%RH,2.5 小时,10 个循环,试验结束 24 ± 4 小时后进行测试。 25°C~65°C,90~100%RH, 2.5H; 65°C 90~100%RH, 3H; 65°C~25°C 80~100%RH, 2.5H, 10 cycles, Measurement at 24 ± 4 hours after test conclusion. | $\pm(2.00\% + 0.05\Omega)$ |

车用厚膜晶片电阻
Automotive Thick Chip Resistor
FRQ Series



■应用 (Application)

- Automotive electronics
- Navigation equipment, TPMS
- Heating, Ventilating and Air conditioning
- Indoor lighting, Central door locking, Wiper module

- 汽车电子
- 导航设备、胎压监测
- 暖气系统、通风系统、空调
- 室内照明、中央门锁、雨刮器模块

■特性 (Features)

- Small size and lightweight
- Reliability, high quality
- CCD visual quality inspection
- Comply with AEC-Q200 standard

- 体积小、重量轻
- 可靠性、高质量
- 通过 CCD 外观品质检测
- 符合 AEC-Q200 标准

■料号说明 (Parts Number Explanation)

示例 : Example: FRQ0805J102 TS

| F 公司名 | R 产品别 | Q 功能别 | 0805 型别 | J 公差 | 102 字码 | I 包装别 | S 端电极 | 特殊型 |
|-----------------|-----------------|-----------------|--|--|---|--|----------------------------|--------------|
| FOJAN | R:Resistor | Q:Auto-motive | 0201 0402 0603 0805 1206 1210 2010 1812 2512 | B:±0.1% C:±0.25% D:±0.5% F:±1% J:±5% P : Jumper | ±5%:E24 3-digits+blank 102=1KΩ 1R0=1Ω ±1%&Below : E24+E96 : 4-digits 1001=1KΩ 1R00=1Ω | T: 7 inch reel Q:10 inch reel R:13 inch reel B:Bulk | S : Sn C : Cu A : Au | N:Normal |
| Company code | Type code | Functional code | Size code | Tolerance code | Resistance code | Packaging code | Termination code | Special code |

■尺寸 (Dimension)

| 尺寸 dimension |  | | | | |
|-----------------|--|-----------|-----------|-----------|-----------|
| | 单位 (unit) : mm | | | | |
| 型别 (Type) | L | W | H | T1 | T2 |
| 0201 | 0.60±0.03 | 0.30±0.03 | 0.23±0.03 | 0.10±0.05 | 0.15±0.05 |
| 0402 | 1.00±0.05 | 0.50±0.05 | 0.35±0.05 | 0.20±0.10 | 0.25±0.10 |
| 0603 | 1.60±0.10 | 0.80±0.10 | 0.45±0.10 | 0.25±0.15 | 0.25±0.15 |
| 0805 | 2.00±0.10 | 1.25±0.10 | 0.50±0.10 | 0.35±0.20 | 0.35±0.20 |
| 1206 | 3.10±0.10 | 1.60±0.10 | 0.55±0.10 | 0.45±0.20 | 0.40±0.20 |
| 1210 | 3.10±0.10 | 2.60±0.15 | 0.55±0.10 | 0.45±0.15 | 0.50±0.20 |
| 2010 | 5.00±0.10 | 2.50±0.15 | 0.55±0.10 | 0.45±0.15 | 0.50±0.20 |
| 1812 | 4.50±0.20 | 3.10±0.20 | 0.55±0.10 | 0.55±0.20 | 0.70±0.20 |
| 2512 | 6.35±0.10 | 3.10±0.15 | 0.55±0.10 | 0.60±0.20 | 0.50±0.20 |

■电阻结构 (Construction)



| NO. | 结构 construction | 主要材料 Major material |
|-----|--------------------------------|---|
| 1 | 陶瓷基板 Ceramic substrate | 三氧化二铝 Al ₂ O ₃ |
| 2 | 银电极 Conductive layer | 银 Ag |
| 3 | 侧电极 Side conductive layer | 镍铬合金 NiCr |
| 4 | 阻体层 Resistive layer | 氧化钌+玻璃 RuO ₂ + glass |
| 5 | 内保护层 Inner protective layer | 玻璃 Glass |
| 6 | 外保护层 Outer Protective layer | 环氧树脂 Epoxy |
| 7 | 文字 Marking | 环氧树脂 Epoxy |
| 8 | 镍电极 Ni plating layer | 镍 Ni |
| 9 | 锡电极 Sn plating layer | 锡 Matte Tin |

■功率衰减曲线 (Derating Curve)

| 使用温度范围 | -55°C~+125°C(0201) | -55°C~+155°C |
|---------|--|---|
| 说明 | 周围温度若超过70°C至125°C之间,功率可照下图曲线予以修订 | 周围温度若超过70°C至155°C之间,功率可照下图曲线予以修订 |
| 功率衰减曲线图 | <p>Graph showing Load Power Ratio (%) vs Ambient Temperature (°C) for 0201 resistor. The curve is constant at 100% until 70°C, then decreases linearly to 0% at 125°C.</p> | <p>Graph showing Load Power Ratio (%) vs Ambient Temperature (°C) for 155°C resistor. The curve is constant at 100% until 70°C, then decreases linearly to 0% at 155°C.</p> |

■电气特性 (Electrical characteristics)

| 型别 Type | 0201 | 0402 | 0603 | 0805 | 1206 | 1210 | 2010 | 2512 |
|---|-------|-------|-------|-------|-------|-------|-------|-------|
| 绝缘耐压 Dielectric Withstanding Voltage | 75V | 100V | 100V | 300V | 500V | 500V | 500V | 500V |
| 零欧姆阻值 ±5% Resistance Value of Jumper ±5% | <50mΩ | <50mΩ | <50mΩ | <50mΩ | <50mΩ | <50mΩ | <50mΩ | <50mΩ |
| 零欧姆额定电流 Rated Current of Jumper | 0.5A | 1A | 1A | 2A | 2A | 2A | 2A | 2A |
| 零欧姆电阻最大电流 Max Current of Jumper | 1A | 2A | 2A | 5A | 10A | 10A | 10A | 10A |

■电性规格 (Standard Electrical Specifications)

| 型别 Type | 额定功率 (Power Rating at 70°C) | 最高工作电压 Max. RCWV | 最大过负荷电压 Max. Overload Voltage | T.C.R. (PPM/°C) | 阻值范围 Resistance Range |
|------------|-------------------------------------|---------------------|-------------------------------------|--------------------|--------------------------|
| 0201 | 1/20W | 25V | 50V | -100~+300 | 1Ω~10Ω 10 MΩ~22 MΩ |
| | | | | ± 200 | 10Ω~10MΩ |
| 0402 | 1/16W | 50V | 100V | ±200 | 1Ω~10Ω 10 MΩ~22MΩ |
| | | | | ± 100 | 10Ω~10MΩ |
| 0603 | 1/10W | 75V | 150V | ± 200 | 1Ω~10Ω 10 MΩ~22MΩ |
| | | | | ± 100 | 10Ω~10MΩ |
| 0805 | 1/8W | 150V | 300V | ± 200 | 1Ω~10Ω 10 MΩ~22MΩ |
| | | | | ± 100 | 10Ω~10MΩ |
| 1206 | 1/4W | 200V | 400V | ± 200 | 1Ω~10Ω 10 MΩ~22 MΩ |
| | | | | ± 100 | 10Ω~10MΩ |
| 1210 | 1/3W | 200V | 500V | ± 200 | 1Ω~10Ω 10 MΩ~22MΩ |
| | | | | ± 100 | 10Ω~10MΩ |
| 2010 | 3/4W | 200V | 500V | ± 200 | 1Ω~10Ω 10 MΩ~22MΩ |
| | | | | ± 100 | 10Ω~10MΩ |
| 2512 | 1W | 200V | 500V | ± 200 | 1Ω~10Ω 10 MΩ~22MΩ |
| | | | | ± 100 | 10Ω~10MΩ |

如有非标准品的需求,请联系我们的业务部门 For non-standard parts, please contact our sales dept.

■性能 (Performance Specifications)

| 内容 Item | 测试方法 Test Methods | 测试条件 Test Conditions | 规格 Specification |
|---|---------------------------|---|--|
| 温度系数 Temperature Coefficient | JIS C 5201 4.8 | $TCR = (R - R_0) / (t - t_0) R_0 \times 10^6$ (ppm) R_0 电阻在室温下的阻值(resistance at room temperature) R 电阻在 125°C或-55°C下的阻值(resistance at 125°C or -55°C) t_0 室温(room temperature) t 测试温度 (test temperature 125°C or -55°C) | 0201 规格 : $1\Omega \leq R \leq 10\Omega$: -100~+300PPM/°C $10\Omega < R \leq 10M\Omega$: ± 200 PPM/°C 0402~2512 规格 : $1\Omega \leq R \leq 10\Omega$: ± 200 PPM/°C $10\Omega < R \leq 10M\Omega$: ± 100 PPM/°C $10M\Omega < R \leq 22M\Omega$: ± 200 PPM/°C |
| 短时间过负荷 Short-time overload | JIS C 5201 4.13 | 加载 2.5 倍的额定电压 ,时间 5 秒后测量试验前后的阻值变化率。 Applied 2.5 times of rated voltage for 5 second. Measure the variation of resistance. | $\pm(1.00\% + 0.05\Omega)$ |
| 焊锡性 Solderability | JIS C 5201 4.17 | 沾助焊剂后浸入锡炉 ,锡炉温度 245±5°C ,时间 3±0.5 秒。 Dip the terminal in a flux and then dip into a soldering bath at 245±5°C for 3±0.5sec. | > 95%面积上锡 (> 95% coverage) |
| 抗焊锡热 Resist to soldering heat | MIL-STD-202 METHOD 210 | 沾助焊剂后浸入锡炉 ,锡炉温度 260±5°C ,时间 10±0.5 秒, 测量试验前后的阻值变化率。 Dip the terminal in a flux and then dip into a soldering bath at 260±5°C for 10±0.5sec. Measure the variation of resistance. | $\pm(1.00\% + 0.05\Omega)$ |
| 绝缘电阻 Insulation resistance | JIS C 5201 4.6 | 电阻本体上加载绝缘耐压 60±5 秒后 , 测量绝缘阻抗。 Applied the dielectric withstanding voltage on the center of body for 60±5seconds. Then measure insulation resistance. | >10GΩ |
| 绝缘耐压 Dielectric withstanding voltage | JIS C 5201 4.7 | 电阻本体上加载绝缘耐压 60±5 秒。 Applied the dielectric withstanding voltage on the center of body for60±5seconds. | 无击穿、飞弧及可见机械性损伤 No evidence of flashover, mechanical damage arcing or insulation breakdown |

| 内容 Item | 测试方法 Test Methods | 测试条件 Test Conditions | 规格 Specification |
|--|---------------------------|--|---------------------|
| 温度循环 Temperature Cycling | JESD22 METHOD JA-104 | -55℃~+155℃, 循环 1000 次, 在每一个极限温度持续时间不超过 30 分钟, 且温度转换时间不超过 1 分钟, 试验结束 24±4 小时后进行测试. 1000 Cycles (-55℃ to +155℃) Measurement at 24±4 hours after test conclusion. 30min maximum dwell time at each temperature extreme. 1min. maximum transition time. | ±(2.00% +0.05Ω) |
| 耐湿特性 Humidity | MIL-STD-202 METHOD 103 | 加载 10%额定功率, 85℃/85%RH, 持续通电 1000H, 试验结束 24±4 小时后进行测试 1000 hours 85℃/85%RH. Note: Specified conditions: 10% of operating power. Measurement at 24±4 hours after test conclusion. | ±(2.00% +0.05Ω) |
| 负荷寿命 Load life | MIL-STD-202 METHOD 108 | 电阻放入恒温箱中, 温度 125±2℃, ON TIME:1.5H, OFF TIME:0.5H, 通电额定电压 1000 ^{+24/-0} 小时, 量测试验前后阻值变化率. Put the specimen in a chamber at 125±2℃ temperature, ON TIME:1.5H, OFF TIME:0.5H, and applied rated voltage for 1000 ^{+24/-0} H. Measure the variation of resistance. | ±(2.00% +0.05Ω) |
| 温湿循环 Moisture resistance | MIL-STD-202 METHOD 106 | 25℃~65℃,90~100%RH, 2.5 小时; 65℃ 90~100%RH, 3 小时; 65℃~25℃,80~100%RH,2.5 小时,10 个循环,试验结束 24±4 小时后进行测试. 25℃~65℃,90~100%RH, 2.5H; 65℃ 90~100%RH, 3H; 65℃~25℃ 80~100%RH, 2.5H, 10 cycles, Measurement at 24±4 hours after test conclusion. | ±(2.00% +0.05Ω) |
| 高温储存 High Temperature Exposure(Storag) | MIL-STD-202 METHOD 108 | 155℃下放置 1000h,不加载功率, 试验结束 24±4 小时后进行测试. 1000 hrs. @ T=155℃. Unpowered. Measurement at 24±4 hours after test conclusion | ±(1.00%+0.05Ω) |

| 内容 Item | 测试方法 Test Methods | 测试条件 Test Conditions | 规格 Specification |
|---------------------------|----------------------|---|---------------------|
| 端子弯曲 Terminal bending | AEC-Q200-005 | 电阻焊接在测试板上进行弯折,弯折保持时间 20±1 秒, 1206(含) 以下的尺寸弯曲 5+0.2/0 mm; 1210 以上的尺寸弯曲 2+0.2/0 mm; 量测试验前后阻值变化率 Specimen shall be mounted on test board, then bend the board and maintained for 20±1s. the distance of bending is 5+0.2/0 mm for resistors which size no larger than 1206 or 2+0.2/0 mm which size larger than 1206. Measure the variation of resistance. | ±(1.00% +0.05Ω) |
| ESD 试验 ESD test | AEC-Q200-002 | 加载规定静电电压2次/间隔1秒, 0201/0402规格:0.5KV, 0603规格:1KV, 其它规格2KV. 0201/0402: 0.5KV, 0603: 1.0KV, Other:2KV, 2times/1s | ±(3.0%+0.05Ω) |
| 抗硫化试验 Sulfuration test | ASTM-B-809-95 | 方法一: 温度60℃, 湿热蒸硫粉试验(加饱和硝酸钾) 750hrs 方法二: 切削油:硫粉=96.5:3.5, 温度60℃, 100 hrs; 预处理: 前后先经历3次回流焊+100次温冲 Method 1: steam sulfur powder test (with saturated potassium nitrate) at 60℃ with humidity and heat (750hrs) Method 2: cutting oil: sulfur powder =96.5:3.5, temperature 60℃, 100 hrs; Pretreatment: before and after three reflow soldering +100 thermal shock | ±(1.0% +0.05Ω) |

抗浪涌厚膜晶片电阻
Anti-Surgege Thick Film Chip Resistor
FRS



■应用(Application)

- Telecommunications
- Power supplies
- Car electronics
- 电信
- 电源供应器
- 汽车电力

■特性(Features)

- Small size and light weight
- Reliability, high quality
- Special material and design for high working voltage require
- 体积小，重量轻
- 可靠性，高质量
- 对高工作电压要求的特殊材质和设计

■料号说明(Parts Number Explanation) :

示例 Example: FRS1206J103 TS

| E 公司名 | R 产品别 | S 功能别 | 1206 型别 | J 公差 | 103 字码 | I 包装别 | S 端电极 | 特殊型 |
|-----------------|--|--|--|--|---|--|----------------------------|---------------------|
| FOJAN | R:Resistor C:Capacitor L:Inductor D:Diode A:Audion | C:Normal P:Hi-Power L:Lowohmic A:Array S:Surge H:Hi-Precision V:Hi-Voltage Q:Auto-motive R:Anti-sulfur M:Metal D:(LED) | 0603 0805 1206 1210 2010 2512 | B:±0.1% C:±0.25% D:±0.5% F:±1% J:±5% P : Jumper | ±5%:E24 3-digits+blank 102=1KΩ 1R0=1Ω ±1%&Below : E24+E96 : 4-digits 1001=1KΩ 1R00=1Ω | T: 7 inch reel Q:10 inch reel R:13 inch reel B:Bulk | S : Sn C : Cu A : Au | N:Normal D : LED |
| Company code | Type code | Functional code | Size code | Tolerance code | Resistance code | Packaging code | Termination code | Special code |

■尺寸 (Dimension)

| 尺寸 dimension |  | | | | |
|-----------------|--|-----------|-----------|-----------|-----------|
| 型别 (Type) | L | W | H | T1 | T2 |
| 0603 | 1.60±0.10 | 0.80±0.10 | 0.45±0.10 | 0.25±0.15 | 0.25±0.15 |
| 0805 | 2.00±0.10 | 1.25±0.10 | 0.50±0.10 | 0.35±0.20 | 0.35±0.20 |
| 1206 | 3.10±0.10 | 1.60±0.10 | 0.55±0.10 | 0.45±0.20 | 0.40±0.20 |
| 1210 | 3.10±0.10 | 2.60±0.15 | 0.55±0.10 | 0.45±0.15 | 0.50±0.20 |
| 2010 | 5.00±0.10 | 2.50±0.15 | 0.55±0.10 | 0.45±0.15 | 0.50±0.20 |
| 2512 | 6.35±0.10 | 3.10±0.15 | 0.55±0.10 | 0.60±0.20 | 0.50±0.20 |

单位 (unit) : mm

■电阻结构 (Construction)

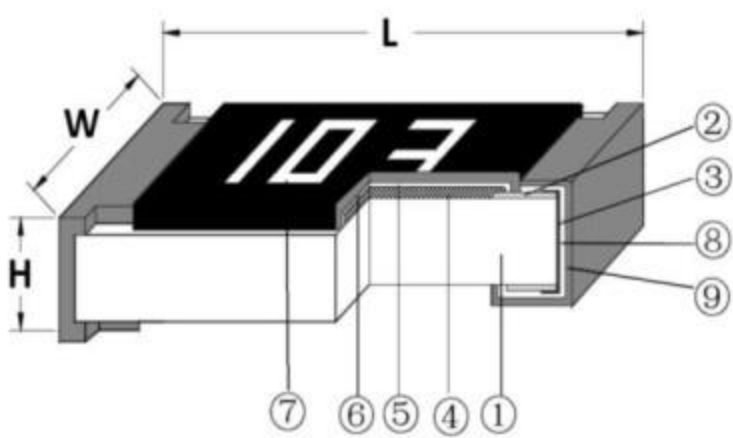

| NO. | 结构 construction | 主要材料 Major material |
|-----|--------------------------------|---|
| 1 | 陶瓷基板 Ceramic substrate | 三氧化二铝 Al ₂ O ₃ |
| 2 | 银电极 Conductive layer | 银 Ag |
| 3 | 侧电极 Side conductive layer | 镍铬合金 NiCr |
| 4 | 阻体层 Resistive layer | 氧化钌+玻璃 RuO ₂ +glass |
| 5 | 内保护层 Inner protective layer | 玻璃 Glass |
| 6 | 外保护层 Outer Protective layer | 环氧树脂 Epoxy |
| 7 | 文字 Marking | 环氧树脂 Epoxy |
| 8 | 镍电极 Ni plating layer | 镍 Ni |
| 9 | 锡电极 Sn plating layer | 锡 Matte Tin |

■尺寸 (Dimension)

| 尺寸 dimension |  | | | | |
|-----------------|--|-----------|-----------|-----------|-----------|
| 单位 (unit) : mm | | | | | |
| 型别 (Type) | L | W | H | T1 | T2 |
| 0603 | 1.60±0.10 | 0.80±0.10 | 0.45±0.10 | 0.25±0.15 | 0.25±0.15 |
| 0805 | 2.00±0.10 | 1.25±0.10 | 0.50±0.10 | 0.35±0.20 | 0.35±0.20 |
| 1206 | 3.10±0.10 | 1.60±0.10 | 0.55±0.10 | 0.45±0.20 | 0.40±0.20 |
| 1210 | 3.10±0.10 | 2.60±0.15 | 0.55±0.10 | 0.45±0.15 | 0.50±0.20 |
| 2010 | 5.00±0.10 | 2.50±0.15 | 0.55±0.10 | 0.45±0.15 | 0.50±0.20 |
| 2512 | 6.35±0.10 | 3.10±0.15 | 0.55±0.10 | 0.60±0.20 | 0.50±0.20 |

■电阻结构 (Construction)



| NO. | 结构 construction | 主要材料 Major material |
|-----|--------------------------------|---|
| 1 | 陶瓷基板 Ceramic substrate | 三氧化二铝 Al ₂ O ₃ |
| 2 | 银电极 Conductive layer | 银 Ag |
| 3 | 侧电极 Side conductive layer | 镍铬合金 NiCr |
| 4 | 阻体层 Resistive layer | 氧化钌+玻璃 RuO ₂ +glass |
| 5 | 内保护层 Inner protective layer | 玻璃 Glass |
| 6 | 外保护层 Outer Protective layer | 环氧树脂 Epoxy |
| 7 | 文字 Marking | 环氧树脂 Epoxy |
| 8 | 镍电极 Ni plating layer | 镍 Ni |
| 9 | 锡电极 Sn plating layer | 锡 Matte Tin |

■脉冲曲线 (Pulse Load Behavior)

公差 Tolerance : $\pm 0.05\%$ 、 $\pm 1.00\%$ 如下 :



公差 Tolerance : $\pm 5.00\%$ 、 $\pm 10.00\%$ 、 $\pm 20.00\%$ 如下 :



■性能 (Performance Specifications)

| 内容 Item | 测试方法 Test Methods | 测试条件 Test Conditions | 规格 Specification |
|------------------------------------|----------------------|--|--|
| 温度系数 Temperature Coefficient | JIS C 5201 4.8 | $TCR = (R - R_0) / (t - t_0) R_0 \times 10^6$ (ppm) R ₀ 电阻在室温下的阻值(resistance at room temperature) R 电阻在 125℃或-55℃下的阻值 (resistance at 125℃ or -55℃) t ₀ 室温(room temperature) t 测试温度 (test temperature 125℃ or -55℃) | 1Ω<R≤10Ω: ±200 PPM/℃ 10Ω<R≤10MΩ: ±100 PPM/℃ |
| 短时间过负荷 Short-time overload | JIS C 5201 4.13 | 加载 2.5 倍的额定电压 ,时间 5 秒后测量试验前后的阻值变化率。 Applied 2.5 times of rated voltage for 5 second. Measure the variation of resistance. | ±(1.00% +0.05Ω) |
| 焊锡性 Solderability | JIS C 5201 4.17 | 沾助焊剂后浸入锡炉, 锡炉温度 245±5℃, 时间 3±0.5 秒。 Dip the terminal in a flux and then dip into a soldering bath at 245±5℃ for 3±0.5sec. | > 95%面积上锡 (> 95% coverage) |
| 抗焊锡热 Resist to soldering heat | JIS C 5201 4.18 | 沾助焊剂后浸入锡炉, 锡炉温度 260±5℃, 时间 10±0.5 秒, 测量试验前后的阻值变化率。 Dip the terminal in a flux and then dip into a soldering bath at 260±5℃ for 10±0.5sec. Measure the variation of resistance. | ±(1.00% +0.05Ω) |
| 绝缘电阻 Insulation resistance | JIS C 5201 4.6 | 电阻本体上加载绝缘耐压 60±5 秒后, 测量绝缘阻抗。 Applied the dielectric withstanding voltage on the center of body for 60±5seconds. Then measure insulation resistance. | >10GΩ |

| 内容 Item | 测试方法 Test Methods | 测试条件 Test Conditions | 规格 Specification |
|---|----------------------|---|--|
| 绝缘耐压 Dielectric withstanding voltage | JIS C 5201 4.7 | 电阻本体上加载绝缘耐压 60±5 秒。 Applied the dielectric withstanding voltage on the center of body for 60±5 seconds. | 无击穿、飞弧及可见机械性损伤 No evidence of flashover, mechanical damage arcing or insulation breakdown |
| 端子弯曲 Terminal bending | JIS C 5201 4.33 | 电阻焊接在测试板上进行弯折,弯折保持时间 20±1 秒, 1206(含) 以下的尺寸弯曲 5+0.2/0 mm; 1206 以上的尺寸弯曲 2+0.2/0 mm; 量测试前后阻值变化率 Specimen shall be mounted on test board, then bend the board and maintained for 20±1s. the distance of bending is 5+0.2/0 mm for resistors which size no larger than 1206 or 2+0.2/0 mm which size larger than 1206. Measure the variation of resistance. | ±(1.00% +0.05Ω) |
| 温度循环 Temperature Cycling | JIS C 5201 4.19 | 电阻放入温度循环机中,温度 155±2℃ 至-55±3℃, 共 5 个循环。量测试前后阻值变化率。 Put specimen in a chamber which temperature can be changed to 155±2℃ or -55±3℃, repeated 5 times. Measure the variation of resistance. | ±(2.00% +0.05Ω) |

| 内容 Item | 测试方法 Test Methods | 测试条件 Test Conditions | 规格 Specification |
|-----------------------------|------------------------|---|----------------------------|
| 耐湿特性 Humidity | JIS C 5201 4.24 | <p>电阻放入恒温恒湿箱，温度 $40\pm 2^{\circ}\text{C}$，湿度 90~95 %RH;通电额定电压 1.5 小时，断电 0.5 小时；重复通断电至试验时间 $1000^{+48}/_{-0}$ 小时。量测试验前后阻值变化率。</p> <p>Put the specimen in a chamber at $40\pm 2^{\circ}\text{C}$ temperature and 90~95% relative humidity, then applied rated voltage for 1.5H and rested for 0.5H repeatedly till total test time is $1000^{+48}/_{-0}$ H. Measure the variation of resistance.</p> | $\pm(2.00\% + 0.05\Omega)$ |
| 负荷寿命 Load life | JIS C 5201 4.25.1 | <p>电阻放入恒温箱中，温度 $70\pm 2^{\circ}\text{C}$，ON TIME:1.5H，OFF TIME:0.5H，通电额定电压 $1000^{+24}/_{-0}$ 小时，量测试验前后阻值变化率。</p> <p>Put the specimen in a chamber at $70\pm 2^{\circ}\text{C}$ temperature, ON TIME:1.5H，OFF TIME:0.5H，and applied rated voltage for $1000^{+24}/_{-0}$H. Measure the variation of resistance.</p> | $\pm(2.00\% + 0.05\Omega)$ |
| 温湿循环 Moisture resistance | MIL-STD-202 METHOD 106 | <p>$25^{\circ}\text{C}\sim 65^{\circ}\text{C}$,90~100%RH, 2.5 小时; 65°C 90~100%RH, 3 小时; $65^{\circ}\text{C}\sim 25^{\circ}\text{C}$,80~100%RH,2.5 小时,10 个循环,试验结束 24 ± 4 小时后进行测试。</p> <p>$25^{\circ}\text{C}\sim 65^{\circ}\text{C}$,90~100%RH, 2.5H; 65°C 90~100%RH, 3H; $65^{\circ}\text{C}\sim 25^{\circ}\text{C}$ 80~100%RH, 2.5H, 10 cycles, Measurement at 24 ± 4 hours after test conclusion.</p> | $\pm(2.00\% + 0.05\Omega)$ |

晶片厚膜排列电阻 Thick Film Chip Resistor Array FRA Series



应用(Application)

- Terminal for SDRAM and DDRAM
- Computer applications : laptop ; desktop
- Consume electronic equipments : PDAs ; PNDs
- Mobile phone telecom...
- SDRAM 和 DDRAM 终端
- 计算机应用
- 消费电子设备 : PDA ; PND
- 手机, 电信等

特性(Features)

- Small size and light weight
- Reliability, high quality
- Saving of PCB space
- 体积小, 重量轻
- 可靠性, 高质量
- 节省空间

料号说明(Parts Number Explanation) :

示例 Example: FRA064RJ750 TS

| E 公司名 | R 产品别 | A 功能别 | 064R 型别 | J 公差 | 103 字码 | I 包装别 | S 端电极 | 特殊型 |
|-----------------|--|---|-------------------|--|---|--|----------------------------|----------------------|
| FOJAN | R:Resistor C:Capacitor L:Inductor D:Diode A:Audion | C:Normal P:Hi-Power L:Lowohmic A:Array S:Surge H:Hi-Precision V:Hi-Voltage Q:Auto-motive R:Anti-sulfur M:Metal D: (LED) | 064R 044R | B:±0.1% C:±0.25% D:±0.5% F:±1% J:±5% P : Jumper | ±5%:E24 3-digits+blank 102=1KΩ 1R0=1Ω ±1%&Below : E24+E96 : 4-digits 1001=1KΩ 1R00=1Ω | T: 7 inch reel Q:10 inch reel R:13 inch reel B:Bulk | S : Sn C : Cu A : Au | N: Normal D : LED |
| Company code | Type code | Functional code | Size code | Tolerance code | Resistance code | Packaging code | Termination code | Special code |

■尺寸 (Dimension)

| | | | | | | | | |
|-----------------|--|-----------|-----------|-----------|-----------|-----------|-----------|----------------|
| 尺寸 dimension |  | | | | | | | 单位 (unit) : mm |
| | 型别 (Type) | L | W | H | L1 | Q | P | L2 |
| 064R | 3.20±0.15 | 1.60±0.15 | 0.60±0.10 | 0.30±0.15 | 0.50±0.15 | 0.80±0.15 | 0.30±0.15 | |
| 044R | 2.00±0.10 | 1.00±0.10 | 0.45±0.10 | 0.20±0.10 | 0.30±0.10 | 0.50±0.10 | 0.20±0.10 | |

■电阻结构 (Construction)



| NO. | 结构 construction | 主要材料 Major material |
|-----|--------------------------------|---|
| 1 | 陶瓷基板 Ceramic substrate | 三氧化二铝 Al ₂ O ₃ |
| 2 | 银电极 Conductive layer | 银 Ag |
| 3 | 阻体层 Resistive layer | 氧化钌+玻璃 RuO ₂ + glass |
| 4 | 内保护层 Inner protective layer | 玻璃 Glass |
| 5 | 外保护层 Outer Protective layer | 环氧树脂 Epoxy |
| 6 | 文字 Marking | 环氧树脂 Epoxy |
| 7 | 镍电极 Ni plating layer | 镍 Ni |
| 8 | 锡电极 Sn plating layer | 锡 Matte Tin |

■功率衰减曲线 (Derating Curve)



■电性规格 (Standard Electrical Specifications)

| 型别 Type | 额定功率 (Power Rating at 70°C) | 最高工作电压 Max. RCWV | 最大过负荷电压 Max. Overload Voltage | 绝缘耐压 Dielectric Withstanding Voltage | T.C.R. (PPM/°C) | 阻值范围 Resistance Range |
|------------|----------------------------------|---------------------|----------------------------------|---|--------------------|--------------------------|
| 064R | 1/10W | 50V | 100V | 100V | ± 200 | 1Ω~1MΩ |
| 044R | 1/16W | 25V | 50V | 100V | ± 250 | 1Ω~10Ω |
| | | | | | ± 200 | 10Ω~1MΩ |

如有非标准品的需求,请联系我们的业务部门 For non-standard parts, please contact our sales dept.

■性能 (Performance Specifications)

| 内容 Item | 测试方法 Test Methods | 测试条件 Test Conditions | 规格 Specification |
|---------------------------------|----------------------|---|--|
| 温度系数 Temperature Coefficient | JIS C 5201 4.8 | $TCR = (R - R_0) / (t - t_0) R_0 \times 10^6$ (ppm) R_0 电阻在室温下的阻值(resistance at room temperature) R 电阻在 125°C或-55°C下的阻值(resistance at 125°C or -55°C) t_0 室温(room temperature) t 测试温度 (test temperature 125°C or -55°C) | 044R : 1Ω<R≦10Ω: ±250 PPM/°C 10Ω<R≦1MΩ: ±200 PPM/°C 064R : ±200 PPM/°C |

| 内容 Item | 测试方法 Test Methods | 测试条件 Test Conditions | 规格 Specification |
|---|----------------------|---|--|
| 短时间过负荷 Short-time overload | JIS C 5201 4.13 | 加载 2.5 倍的额定电压 ,时间 5 秒后测量试验前后的阻值变化率。 Applied 2.5 times of rated voltage for 5 second. Measure the variation of resistance. | $\pm(1.00\% +0.05\Omega)$ |
| 焊锡性 Solderability | JIS C 5201 4.17 | 沾助焊剂后浸入锡炉，锡炉温度 $245\pm 5^{\circ}\text{C}$ ，时间 3 ± 0.5 秒。 Dip the terminal in a flux and then dip into a soldering bath at $245\pm 5^{\circ}\text{C}$ for $3\pm 0.5\text{sec}$. | > 95%面积上锡 (> 95% coverage) |
| 抗焊锡热 Resist to soldering heat | JIS C 5201 4.18 | 沾助焊剂后浸入锡炉，锡炉温度 $260\pm 5^{\circ}\text{C}$ ，时间 10 ± 0.5 秒，测量试验前后的阻值变化率。 Dip the terminal in a flux and then dip into a soldering bath at $260\pm 5^{\circ}\text{C}$ for $10\pm 0.5\text{sec}$. Measure the variation of resistance. | $\pm(1.00\% +0.05\Omega)$ |
| 绝缘电阻 Insulation resistance | JIS C 5201 4.6 | 电阻本体上加载绝缘耐压 60 ± 5 秒后，测量绝缘阻抗。 Applied the dielectric withstanding voltage on the center of body for $60\pm 5\text{seconds}$. Then measure insulation resistance. | >10G Ω |
| 绝缘耐压 Dielectric withstanding voltage | JIS C 5201 4.7 | 电阻本体上加载绝缘耐压 60 ± 5 秒。 Applied the dielectric withstanding voltage on the center of body for $60\pm 5\text{seconds}$. | 无击穿、飞弧及可见机械性损伤 No evidence of flashover, mechanical damage arcing or insulation breakdown |

| 内容 Item | 测试方法 Test Methods | 测试条件 Test Conditions | 规格 Specification |
|-----------------------------|------------------------|---|---------------------|
| 端子弯曲 Terminal bending | JIS C 5201 4.33 | 电阻焊接在测试板上进行弯折,弯折保持时间 20±1 秒, 1206(含) 以下的尺寸弯曲 5+0.2/0 mm; 1206 以上的尺寸弯曲 2+0.2/0 mm; 量测试前后阻值变化率 Specimen shall be mounted on test board, then bend the board and maintained for 20±1s. the distance of bending is 5+0.2/0 mm for resistors which size no larger than 1206 or 2+0.2/0 mm which size larger than 1206. Measure the variation of resistance. | ±(1.00% +0.05Ω) |
| 温度循环 Temperature Cycling | JIS C 5201 4.19 | 电阻放入温度循环机中,温度 155±2℃ 至-55±3℃, 共 5 个循环。量测试前后阻值变化率。 Put specimen in a chamber which temperature can be changed to 155±2℃ or -55±3℃, repeated 5 times. Measure the variation of resistance. | ±(2.00% +0.05Ω) |
| 耐湿特性 Humidity | JIS C 5201 4.24 | 电阻放入恒温恒湿箱, 温度 40±2℃, 湿度 90~95 %RH;通电额定电压 1.5 小时, 断电 0.5 小时;重复通断电至试验时间 1000 ^{+48/-0} 小时。量测试前后阻值变化率。 Put the specimen in a chamber at 40±2℃ temperature and 90~95% relative humidity, then applied rated voltage for 1.5H and rested for 0.5H repeatedly till total test time is 1000 ^{+48/-0} H. Measure the variation of resistance. | ±(2.00% +0.05Ω) |
| 负荷寿命 Load life | JIS C 5201 4.25.1 | 电阻放入恒温箱中,温度 70±2℃, ON TIME:1.5H, OFF TIME:0.5H, 通电额定电压 1000 ^{+24/-0} 小时,量测试前后阻值变化率。 Put the specimen in a chamber at 70±2℃ temperature, ON TIME:1.5H OFF TIME:0.5H, and applied rated voltage for 1000 ^{+24/-0} H. Measure the variation of resistance. | ±(2.00% +0.05Ω) |
| 温湿循环 Moisture resistance | MIL-STD-202 METHOD 106 | 25℃~65℃,90~100%RH, 2.5 小时; 65℃ 90~100%RH, 3 小时; 65℃~25℃,80~100%RH,2.5 小时,10 个循环,试验结束 24±4 小时后进行测试。 25℃~65℃,90~100%RH, 2.5H; 65℃ 90~100%RH, 3H; 65℃~25℃ 80~100%RH, 2.5H, 10 cycles, Measurement at 24±4 hours after test conclusion. | ±(2.00% +0.05Ω) |

抗硫化厚膜晶片电阻 Anti-Sulfur Thick Film Chip Resistor FRR Series



应用 (Application)

- Industrial Equipent
- Power Application
- Networking Application
- High-end Computer & Multimedia Electronics in high sulfur environment
- Automotive electronics
- 工业设备
- 电源应用
- 网络应用
- 高硫环境下的高端计算机与多媒体电子
- 汽车电子

特性 (Features)

- AEC-Q200 qualified
- Superior resistance against sulfur containing atmosphere
- AEC-Q200 合格
- 优异的抗硫性

料号说明 (Parts Number Explanation)

示例 Example: FRR1206J101 TS

| F 公司名 | R 产品别 | R 功能别 | 1206 尺寸 | J 公差 | 101 字码 | T 包装别 | S 端电极 | 特殊码 |
|-----------------|--|---|--|---|---|--|----------------------------|---------------------|
| FOJAN | R:Resistor C:Capacitor L:Inductor D:Diode A:Audion | C:Normal P:Hi-Power L:Lowohmic A:Array S:Surge H:Hi-Precision V:Hi-Voltage Q:Auto-motive R:Anti-sulfur M:Metal D: LED | 0201 0402 0603 0805 1206 1210 1218 1812 2010 2512 | B:±0.1% C:±0.25% D:±0.5% F:±1% J:±5% P: Jumper | ±5%:E24 3-digits+blank 102=1KΩ 1R0=1Ω ±1%&Below : E24+E96 : 4-digits 1001=1KΩ 1R00=1Ω | T: 7 inch reel Q:10 inch reel R:13 inch reel B:Bulk | S : Sn C : Cu A : Au | N:Normal D : LED |
| Company code | Type code | Functional code | Size code | Tolerance code | Resistance code | Packaging code | Termination code | Special Case |

■尺寸 (Dimension):

| 尺寸 dimension |  | | | | |
|-----------------|--|-----------|-----------|-----------|-----------|
| | 单位 (unit) : mm | | | | |
| 型别 (Type) | L | W | H | T1 | T2 |
| 0402 | 1.00±0.05 | 0.50±0.05 | 0.35±0.05 | 0.20±0.10 | 0.25±0.10 |
| 0603 | 1.60±0.10 | 0.80±0.10 | 0.45±0.10 | 0.25±0.15 | 0.25±0.15 |
| 0805 | 2.00±0.10 | 1.25±0.10 | 0.50±0.10 | 0.35±0.20 | 0.35±0.20 |
| 1206 | 3.10±0.10 | 1.60±0.10 | 0.55±0.10 | 0.45±0.20 | 0.40±0.20 |
| 1210 | 3.10±0.10 | 2.60±0.15 | 0.55±0.10 | 0.45±0.15 | 0.50±0.20 |
| 2010 | 5.00±0.10 | 2.50±0.15 | 0.55±0.10 | 0.45±0.15 | 0.50±0.20 |
| 2512 | 6.35±0.10 | 3.10±0.15 | 0.55±0.10 | 0.60±0.20 | 0.50±0.20 |

■电阻结构 (Construction)



| NO. | 结构 construction | 主要材料 Major material |
|-----|--------------------------------|---|
| 1 | 陶瓷基板 Ceramic substrate | 三氧化二铝 Al ₂ O ₃ |
| 2 | 银电极 Conductive layer | 银 Ag |
| 3 | 侧电极 Side conductive layer | 镍铬合金 NiCr |
| 4 | 阻体层 Resistive layer | 氧化钌+玻璃 RuO ₂ +glass |
| 5 | 内保护层 Inner protective layer | 玻璃 Glass |
| 6 | 外保护层 Outer Protective layer | 环氧树脂 Epoxy |
| 7 | 文字 Marking | 环氧树脂 Epoxy |
| 8 | 镍电极 Ni plating layer | 镍 Ni |
| 9 | 锡电极 Sn plating layer | 锡 Matte Tin |

■ 功率衰减曲线 (Derating Curve) :



■ 电气特性 (Electrical characteristics) :

| 型别 Type | 0402 | 0603 | 0805 | 1206 | 1210 | 2010 | 2512 |
|---|-------|-------|-------|-------|-------|-------|-------|
| 绝缘耐压 Dielectric Withstanding Voltage | 100V | 100V | 300V | 500V | 500V | 500V | 500V |
| 零欧姆阻值 ±5% Resistance Value of Jumper ±5% | <50mΩ | <50mΩ | <50mΩ | <50mΩ | <50mΩ | <50mΩ | <50mΩ |
| 零欧姆额定电流 Rated Current of Jumper | 1A | 1A | 2A | 2A | 2A | 2A | 2A |
| 零欧姆电阻最大电流 Max Current of Jumper | 2A | 2A | 5A | 10A | 10A | 10A | 10A |

■ 电性规格 (Standard Electrical Specifications)

| 型别 Type | 额定功率 (Power Rating at 70°C) | 最高工作电压 Max. RCWV | 最大过负荷电压 Max. Overload Voltage | T.C.R. (PPM/°C) | 阻值范围 Resistance Range |
|------------|-------------------------------------|---------------------|-------------------------------------|--------------------|--------------------------|
| 0402 | 1/16W | 50V | 100V | ±200 PPM/°C | 1Ω~10Ω 10M Ω~22M Ω |
| | | | | ±100 PPM/°C | 10 Ω~10M Ω |
| 0603 | 1/10W | 75V | 150V | ±200 PPM/°C | 1Ω~10Ω 10M Ω~22M Ω |
| | | | | ±100 PPM/°C | 10 Ω~10M Ω |
| 0805 | 1/8W | 150V | 300V | ±200 PPM/°C | 1Ω~10Ω 10M Ω~22M Ω |
| | | | | ±100 PPM/°C | 10 Ω~10M Ω |

| 型别 Type | 额定功率 (Power Rating at 70°C) | 最高工作电压 Max. RCWV | 最大过负荷电压 Max. Overload Voltage | T.C.R. (PPM/°C) | 阻值范围 Resistance Range |
|------------|-------------------------------------|---------------------|-------------------------------------|--------------------|--------------------------|
| 1206 | 1/4W | 200V | 400V | ±200 PPM/°C | 1Ω~10Ω 10M Ω~22M Ω |
| | | | | ±100 PPM/°C | 10 Ω~10M Ω |
| 1210 | 1/2W | 200V | 500V | ±200 PPM/°C | 1Ω~10Ω |
| | | | | ±100 PPM/°C | 10 Ω~10M Ω |
| 2010 | 3/4W | 200V | 500V | ±200 PPM/°C | 1Ω~10Ω |
| | | | | ±100 PPM/°C | 10 Ω~10M Ω |
| 2512 | 1W | 200V | 500V | ±200 PPM/°C | 1Ω~10Ω |
| | | | | ±100 PPM/°C | 10 Ω~10M Ω |

如有非标准品的需求,请联系我们的业务部门 For non-standard parts, please contact our sales dept.

■性能 (Performance Specifications) :

| 内容 Item | 测试方法 Test Methods | 测试条件 Test Conditions | 规格 Specification |
|-------------------------------------|----------------------|---|---|
| 温度系数 Temperature Coefficient | JIS C 5201 4.8 | $TCR = (R - R_0) / (t - t_0) R_0 \times 10^6$ (ppm) R_0 电阻在室温下的阻值(resistance at room temperature) R 电阻在 125°C或-55°C下的阻值(resistance at 125°C or -55°C) t_0 室温(room temperature) t 测试温度 (test temperature 125°C or -55°C) | 1Ω<R≦10Ω: ±200 PPM/°C 10Ω<R≦10MΩ: ±100 PPM/°C 10MΩ<R≦22MΩ: ±200 PPM/°C |
| 短时间过负荷 Short-time overload | JIS C 5201 4.13 | 加载 2.5 倍的额定电压, 时间 5 秒后测量试验前后的阻值变化率。 Applied 2.5 times of rated voltage for 5 second. Measure the variation of resistance. | ±(1.00% +0.05Ω) |
| 焊锡性 Solderability | JIS C 5201 4.17 | 沾助焊剂后浸入锡炉, 锡炉温度 245±5°C, 时间 3±0.5 秒。 Dip the terminal in a flux and then dip into a soldering bath at 245±5°C for 3±0.5sec. | > 95%面积上锡 (> 95% coverage) |
| 抗焊锡热 Resist to soldering heat | JIS C 5201 4.18 | 沾助焊剂后浸入锡炉, 锡炉温度 260±5°C, 时间 10±0.5 秒, 测量试验前后的阻值变化率。 Dip the terminal in a flux and then dip into a soldering bath at 260±5°C for 10±0.5sec. Measure the variation of resistance. | ±(1.00% +0.05Ω) |

| 内容 Item | 测试方法 Test Methods | 测试条件 Test Conditions | 规格 Specification |
|---|----------------------|---|--|
| 绝缘电阻 Insulation resistance | JIS C 5201 4.6 | 电阻本体上加载绝缘耐压 60±5 秒后，测量绝缘阻抗。 Applied the dielectric withstanding voltage on the center of body for 60±5seconds. Then measure insulation resistance. | >10GΩ |
| 绝缘耐压 Dielectric withstanding voltage | JIS C 5201 4.7 | 电阻本体上加载绝缘耐压 60±5 秒。 Applied the dielectric withstanding voltage on the center of body for 60±5seconds. | 无击穿、飞弧及可见机械性损伤 No evidence of flashover, mechanical damage arcing or insulation breakdown |
| 端子弯曲 Terminal bending | JIS C 5201 4.33 | 电阻焊接在测试板上进行弯折,弯折保持时间 20±1 秒，1206(含) 以下的尺寸弯曲 5+0.2/0 mm; 1206 以上的尺寸弯曲 2+0.2/0 mm; 量测试验前后阻值变化率 Specimen shall be mounted on test board, then bend the board and maintained for 20±1s. the distance of bending is 5+0.2/0 mm for resistors which size no larger than 1206 or 2+0.2/0 mm which size larger than 1206. Measure the variation of resistance. | ±(1.00% +0.05Ω) |
| 温度循环 Temperature Cycling | JIS C 5201 4.19 | 电阻放入温度循环机中，温度 155±2℃至 -55±3℃，共 5 个循环。量测试验前后阻值变化率。 Put specimen in a chamber which temperature can be changed to 155±2℃ or -55±3℃, repeated 5 times. Measure the variation of resistance. | ±(2.00% +0.05Ω) |

| 内容 Item | 测试方法 Test Methods | 测试条件 Test Conditions | 规格 Specification |
|--------------------------------|---------------------------|--|---|
| 负荷寿命 Load life | JIS C 5201 4.25.1 | 电阻放入恒温箱中，温度 $70\pm 2^{\circ}\text{C}$ ，ON TIME:1.5H，OFF TIME:0.5H，通电额定电压 1000 $^{+24}/_{-0}$ 小时，量测试验前后阻值变化率。 Put the specimen in a chamber at $70\pm 2^{\circ}\text{C}$ temperature, ON TIME:1.5H，OFF TIME:0.5H， and applied rated voltage for 1000 $^{+24}/_{-0}$ H. Measure the variation of resistance. | $\pm(2.00\% + 0.05\Omega)$ |
| 温湿循环 Moisture resistance | MIL-STD-202 METHOD 106 | 25 $^{\circ}\text{C}$ ~65 $^{\circ}\text{C}$,90~100%RH, 2.5 小时; 65 $^{\circ}\text{C}$ 90~100%RH, 3 小时; 65 $^{\circ}\text{C}$ ~25 $^{\circ}\text{C}$,80~100%RH,2.5 小时,10 个循环,试 验结束 24 \pm 4 小时后进行测试。 25 $^{\circ}\text{C}$ ~65 $^{\circ}\text{C}$,90~100%RH, 2.5H; 65 $^{\circ}\text{C}$ 90~100%RH, 3H; 65 $^{\circ}\text{C}$ ~25 $^{\circ}\text{C}$ 80~100%RH, 2.5H, 10 cycles, Measurement at 24 \pm 4 hours after test conclusion. | $\pm(2.00\% + 0.05\Omega)$ |
| 抗硫化试验 Sulfuration test | ASTM-B-809-95 | Sulfur 750 hours at 105 $^{\circ}\text{C}$ unpowered | $\pm(4.0\% + 0.05 \Omega) \text{ Max}$ |
| 耐湿特性 Biased Humidity | MIL-STD-202 METHOD 103 | 加载 10% 额定功率，85 $^{\circ}\text{C}$ /85%RH, 持续通电1000H, 试验结束24 \pm 4 小时后进行测试 1000 hours 85 $^{\circ}\text{C}$ /85%RH. Note: Specified conditions: 10% of operating power. Measurement at 24 \pm 4 hours after test conclusion. | $\pm(2.00\% + 0.05\Omega) \text{ Max}$ |

高精度厚膜晶片电阻 High Precision Thick Film Chip Resistor FRH Series



应用 (Application)

- Medical, Precision equipments, Electricmeter
- Converters, Communication devices, Battery
- Measuring instrument , Printers, SmartPhone

- 医疗,精密设备,电表
- 转换器,通信设备,电池
- 测量仪器,印表机,智能手机

特性 (Features)

- Tight tolerance from $\pm 0.1\%$, $\pm 0.25\%$, $\pm 0.5\%$,

- 精密公差 $\pm 0.1\%$, $\pm 0.25\%$, $\pm 0.5\%$,

料号说明 (Parts Number Explanation)

示例 Example: FRH1206D1001 TS

| <u>F</u> 公司名 | <u>R</u> 产品别 | <u>H</u> 功能别 | <u>1206</u> 型别 | <u>D</u> 公差 | <u>1001</u> 字码 | <u>I</u> 包装别 | <u>S</u> 端电极 | 特殊型 |
|-----------------|-----------------|-----------------|--|---|---|--|----------------------------|--------------|
| FOJAN | R:Resistor | H:Hi-Precision | 0402 0603 0805 1206 1210 2010 2512 | B: $\pm 0.1\%$ C: $\pm 0.25\%$ D: $\pm 0.5\%$ F: $\pm 1\%$ J: $\pm 5\%$ P : Jumper | $\pm 5\%$:E24 3-digits+blank 102=1K Ω 1R0=1 Ω $\pm 1\%$ &Below : E24+E96 : 4-digits 1001=1K Ω 1R00=1 Ω | T: 7 inch reel Q:10 inch reel R:13 inch reel B:Bulk | S : Sn C : Cu A : Au | N:Normal |
| Company code | Type code | Functional code | Size code | Tolerance code | Resistance code | Packaging code | Termination code | Special code |

■尺寸 (Dimension)

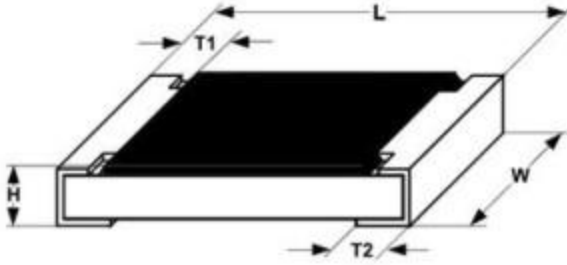
| 尺寸 dimension |  | | | | |
|-----------------|--|-----------|-----------|-----------|-----------|
| | 单位 (unit) : mm | | | | |
| 型别 (Type) | L | W | H | T1 | T2 |
| 0402 | 1.00±0.05 | 0.50±0.05 | 0.35±0.05 | 0.20±0.10 | 0.25±0.10 |
| 0603 | 1.60±0.10 | 0.80±0.10 | 0.45±0.10 | 0.25±0.15 | 0.25±0.15 |
| 0805 | 2.00±0.10 | 1.25±0.10 | 0.50±0.10 | 0.35±0.20 | 0.35±0.20 |
| 1206 | 3.10±0.10 | 1.60±0.10 | 0.55±0.10 | 0.45±0.20 | 0.40±0.20 |
| 1210 | 3.10±0.10 | 2.60±0.15 | 0.55±0.10 | 0.45±0.15 | 0.50±0.20 |
| 2010 | 5.00±0.10 | 2.50±0.15 | 0.55±0.10 | 0.45±0.15 | 0.50±0.20 |
| 2512 | 6.35±0.10 | 3.10±0.15 | 0.55±0.10 | 0.60±0.20 | 0.50±0.20 |

■电阻结构 (Construction)



| NO. | 结构 construction | 主要材料 Major material |
|-----|--------------------------------|---|
| 1 | 陶瓷基板 Ceramic substrate | 三氧化二铝 Al ₂ O ₃ |
| 2 | 银电极 Conductive layer | 银 Ag |
| 3 | 侧电极 Side conductive layer | 镍铬合金 NiCr |
| 4 | 阻体层 Resistive layer | 氧化钌+玻璃 RuO ₂ + glass |
| 5 | 内保护层 Inner protective layer | 玻璃 Glass |
| 6 | 外保护层 Outer Protective layer | 环氧树脂 Epoxy |
| 7 | 文字 Marking | 环氧树脂 Epoxy |
| 8 | 镍电极 Ni plating layer | 镍 Ni |
| 9 | 锡电极 Sn plating layer | 锡 Matte Tin |

■ 功率衰减曲线 (Derating Curve)



■ 阻值范围 (Resistance range)

| 型别 Type | 阻值范围 Resistance Range | |
|---------|--------------------------|---------|
| | 0.5% | 0.1% |
| 0402 | 10Ω~1MΩ | 10Ω~1MΩ |
| 0603 | 10Ω~1MΩ | 10Ω~1MΩ |
| 0805 | 10Ω~1MΩ | 10Ω~1MΩ |
| 1206 | 10Ω~1MΩ | 10Ω~1MΩ |
| 1210 | 10Ω~1MΩ | 10Ω~1MΩ |
| 2010 | 10Ω~1MΩ | 10Ω~1MΩ |
| 2512 | 10Ω~1MΩ | 10Ω~1MΩ |

如有非标准品的需求,请联系我们的业务部门 For non-standard parts, please contact our sales dept.

■ 电气特性 (Electrical characteristics)

| 型别 Type | 0402 | 0603 | 0805 | 1206 | 1210 | 2010 | 2512 |
|---|-------|-------|------|------|------|------|------|
| 额定功率 Rated power | 1/16W | 1/10W | 1/8W | 1/4W | 1/2W | 3/4W | 1W |
| 最大工作电压 Max Working Voltage | 50V | 75V | 150V | 200V | 200V | 200V | 200V |
| 最大过负荷电压 Max Overload Voltage | 100V | 150V | 300V | 400V | 400V | 400V | 400V |
| 绝缘耐压 Dielectric Withstanding Voltage | 100V | 100V | 300V | 500V | 500V | 500V | 500V |

| 型别 Type | 0402 | 0603 | 0805 | 1206 | 1210 | 2010 | 2512 |
|---|-------|-------|-------|-------|-------|-------|-------|
| 零欧姆阻值 ±1% Resistance Value of Jumper ±1% | <30mΩ | <30mΩ | <30mΩ | <30mΩ | <30mΩ | <30mΩ | <30mΩ |
| 零欧姆阻值 ±5% Resistance Value of Jumper ±5% | <50mΩ | <50mΩ | <50mΩ | <50mΩ | <50mΩ | <50mΩ | <50mΩ |
| 零欧姆额定电流 Rated Current of Jumper | 1A | 1A | 2A | 2A | 2A | 2A | 2A |
| 零欧姆电阻最大电流 Max Current of Jumper | 2A | 2A | 5A | 10A | 10A | 10A | 10A |





性能 (Performance Specifications)

| 内容 Item | 测试方法 Test Methods | 测试条件 Test Conditions | 规格 Specification |
|----------------------------------|-------------------|---|---|
| 温度系数 Temperature Coefficient | JIS C 5201 4.8 | $TCR = (R - R_0) / (t - t_0) R_0 \times 10^6$ (ppm) R_0 电阻在室温下的阻值(resistance at room temperature) R 电阻在 125℃或-55℃下的阻值(resistance at 125℃ or -55℃) t_0 室温(room temperature) t 测试温度 (test temperature 125℃ or -55℃) | $1\Omega \leq R \leq 10\Omega$: ± 200 PPM/℃ $10\Omega < R \leq 10M\Omega$: ± 100 PPM/℃ |
| 短时间过负荷 Short-time overload | JIS C 5201 4.13 | 加载 2.5 倍的额定电压，时间 5 秒后测量试验前后的阻值变化率。 Applied 2.5 times of rated voltage for 5 second. Measure the variation of resistance. | $\pm(1.00\% + 0.05\Omega)$ |
| 焊锡性 Solderability | JIS C 5201 4.17 | 沾助焊剂后浸入锡炉，锡炉温度 245±5℃，时间 3±0.5 秒。 Dip the terminal in a flux and then dip into a soldering bath at 245±5℃ for 3±0.5sec. | > 95%面积上锡 (> 95% coverage) |
| 抗焊锡热 Resist to soldering heat | JIS C 5201 4.18 | 沾助焊剂后浸入锡炉，锡炉温度 260±5℃，时间 10±0.5 秒，测量试验前后的阻值变化率。 Dip the terminal in a flux and then dip into a soldering bath at 260±5℃ for 10±0.5sec. Measure the variation of resistance. | $\pm(1.00\% + 0.05\Omega)$ |

| 内容 Item | 测试方法 Test Methods | 测试条件 Test Conditions | 规格 Specification |
|---|----------------------|---|--|
| 绝缘电阻 Insulation resistance | JIS C 5201 4.6 | 电阻本体上加载绝缘耐压 60±5 秒后 ,测量绝缘阻抗。 Applied the dielectric withstanding voltage on the center of body for 60±5seconds. Then measure insulation resistance. | >10GΩ |
| 绝缘耐压 Dielectric withstanding voltage | JIS C 5201 4.7 | 电阻本体上加载绝缘耐压 60±5 秒。 Applied the dielectric withstanding voltage on the center of body for60±5seconds. | 无击穿、飞弧及可见机械性损伤 No evidence of flashover, mechanical damage arcing or insulation breakdown |
| 端子弯曲 Terminal bending | JIS C 5201 4.33 | 电阻焊接在测试板上进行弯折,弯折保持时间 20±1 秒, 1206(含) 以下的尺寸弯曲 5+0.2/0 mm; 1206 以上的尺寸弯曲 2+0.2/0 mm; 量测试前后阻值变化率 Specimen shall be mounted on test board, then bend the board and maintained for 20±1s. the distance of bending is 5+0.2/0 mm for resistors which size no larger than 1206 or 2+0.2/0 mm which size larger than 1206. Measure the variation of resistance. | ±(1.00% +0.05Ω) |
| 温度循环 Temperature Cycling | JIS C 5201 4.19 | 电阻放入温度循环机中, 温度 155±2℃至 -55±3℃, 共 5 个循环。量测试前后阻值变化率。 Put specimen in a chamber which temperature can be changed to 155±2℃ or -55±3℃, repeated 5 times. Measure the variation of resistance. | ±(2.00% +0.05Ω) |

| 内容 Item | 测试方法 Test Methods | 测试条件 Test Conditions | 规格 Specification |
|-----------------------------|------------------------|---|---------------------------|
| 耐湿特性 Humidity | JIS C 5201 4.24 | <p>电阻放入恒温恒湿箱，温度 $40\pm 2^{\circ}\text{C}$，湿度 90~95 %RH;通电额定电压 1.5 小时，断电 0.5 小时；重复通断电至试验时间 $1000^{+48}/_{-0}$ 小时。量测试验前后阻值变化率。</p> <p>Put the specimen in a chamber at $40\pm 2^{\circ}\text{C}$ temperature and 90~95% relative humidity, then applied rated voltage for 1.5H and rested for 0.5H repeatedly till total test time is $1000^{+48}/_{-0}$ H. Measure the variation of resistance.</p> | $\pm(2.00\% +0.05\Omega)$ |
| 负荷寿命 Load life | JIS C 5201 4.25.1 | <p>电阻放入恒温箱中，温度 $70\pm 2^{\circ}\text{C}$，ON TIME:1.5H，OFF TIME:0.5H，通电额定电压 $1000^{+24}/_{-0}$ 小时，量测试验前后阻值变化率。</p> <p>Put the specimen in a chamber at $70\pm 2^{\circ}\text{C}$ temperature, ON TIME:1.5H，OFF TIME:0.5H，and applied rated voltage for $1000^{+24}/_{-0}$H. Measure the variation of resistance.</p> | $\pm(2.00\% +0.05\Omega)$ |
| 温湿循环 Moisture resistance | MIL-STD-202 METHOD 106 | <p>$25^{\circ}\text{C}\sim 65^{\circ}\text{C}$,90~100%RH, 2.5 小时; 65°C 90~100%RH, 3 小时; $65^{\circ}\text{C}\sim 25^{\circ}\text{C}$,80~100%RH,2.5 小时,10 个循环,试验结束 24 ± 4 小时后进行测试。</p> <p>$25^{\circ}\text{C}\sim 65^{\circ}\text{C}$,90~100%RH, 2.5H; 65°C 90~100%RH, 3H; $65^{\circ}\text{C}\sim 25^{\circ}\text{C}$ 80~100%RH, 2.5H, 10 cycles, Measurement at 24 ± 4 hours after test conclusion.</p> | $\pm(2.00\% +0.05\Omega)$ |

电阻本体字码标识 Marking on the Resistor's Body

| | | |
|---|--|--|
| <p>0201 及 0402 因本体太小，本体上无字码标示 For 0201 and 0402 size, no marking on the body due to the small size of the resistor</p> <p>公差±5%的产品，以三字码标示，前两位表示阻值的有效数字，最后一位表示 10 的乘幂 ±5% tolerance product: the marking is 3 digits, the first 2 digits are significant figures of resistance value and the 3rd one denotes the power number of 10, (10X)</p> <p>±0.5%, ±1%, ±2%的产品，以四字码标示，前三位表示阻值的有效数字，最后一位表示 10 的乘幂 ±0.5%, ±1%, ±2% tolerance product: the marking is 4 digits, the first 3 digits are significant figures of resistance value and the 4th one denotes the power number of 10, (10X)</p> <p>0603 ±1% E96 系列的标准阻值，因电阻本体太小，采用三位代码标示。 Standard E96 series values of 0603 ±1%: due to the small size of the resistor's body, use 3digits code to indicate the resistance value.</p> |     | <p>472=47×10²=4.7KΩ</p> <hr/> <p>10Ω以下标示：5R6=5.6Ω Below 10Ω: 5R6=5.6Ω</p> <hr/> <p>4992=499×10²=49.9KΩ</p> <hr/> <p>100Ω以下标示：6R81=6.81Ω Below 100Ω: 6R81=6.81Ω</p> |
|---|--|--|

用于 0603±1%标记的标准 E96 系列电阻值代码 Standard E96 Series Resistance Value Code for 0603 ±1% Marking

| 代码 Code | 阻值 Value | 代码 Code | 阻值 Value | 代码 Code | 阻值 Value | 代码 Code | 阻值 Value | 代码 Code | 阻值 Value | 代码 Code | 阻值 Value |
|------------|-------------|------------|-------------|------------|-------------|------------|-------------|------------|-------------|------------|-------------|
| 01 | 100 | 17 | 147 | 33 | 215 | 49 | 316 | 65 | 464 | 81 | 681 |
| 02 | 102 | 18 | 150 | 34 | 221 | 50 | 324 | 66 | 475 | 82 | 698 |
| 03 | 105 | 19 | 154 | 35 | 226 | 51 | 332 | 67 | 487 | 83 | 715 |
| 04 | 107 | 20 | 158 | 36 | 223 | 52 | 340 | 68 | 499 | 84 | 732 |
| 05 | 110 | 21 | 162 | 37 | 237 | 53 | 348 | 69 | 511 | 85 | 750 |
| 06 | 113 | 22 | 165 | 38 | 243 | 54 | 357 | 70 | 523 | 86 | 768 |
| 07 | 115 | 23 | 169 | 39 | 249 | 55 | 365 | 71 | 536 | 87 | 787 |
| 08 | 118 | 24 | 174 | 40 | 255 | 56 | 374 | 72 | 549 | 88 | 806 |
| 09 | 121 | 25 | 178 | 41 | 261 | 57 | 383 | 73 | 562 | 89 | 825 |
| 10 | 124 | 26 | 182 | 42 | 267 | 58 | 392 | 74 | 576 | 90 | 845 |
| 11 | 127 | 27 | 187 | 43 | 274 | 59 | 402 | 75 | 590 | 91 | 866 |
| 12 | 130 | 28 | 191 | 44 | 280 | 60 | 412 | 76 | 604 | 92 | 887 |
| 13 | 133 | 29 | 196 | 45 | 287 | 61 | 422 | 77 | 619 | 93 | 909 |
| 14 | 137 | 30 | 200 | 46 | 294 | 62 | 432 | 78 | 634 | 94 | 931 |
| 15 | 140 | 31 | 205 | 47 | 301 | 63 | 442 | 79 | 649 | 95 | 953 |
| 16 | 143 | 32 | 210 | 48 | 309 | 64 | 453 | 80 | 665 | 96 | 976 |

0603±1%标记的倍增码：Multiplier Code for 0603 ±1% Marking:

| 代码 Code | Y | X | A | B | C | D | E | F |
|---------------|-----------|-----------|--------|--------|--------|--------|--------|--------|
| 指数 Multiplier | 10^{-2} | 10^{-1} | 10^0 | 10^1 | 10^2 | 10^3 | 10^4 | 10^5 |

阻值标示如下(So the resistance value are marked as the following examples)



$$10D = 124 \times 10^3 = 124K\Omega$$



$$38Y = 243 \times 10^{-2} = 2.43\Omega$$

0603 ±1%的产品，在标准 E24 系列中，但不属于 E96 系列，标示与 5%的字码相同，但是在中间字码下加一条线 (Standard E24 and not belong to E96 series values of 0603 ±1%, the marking is the same as 5% tolerance but marking as underline)



$$33\underline{1} = 33 \times 10^1 = 330\Omega$$



$$56\underline{0} = 56 \times 10^0 = 56\Omega$$

FRL 系列低阻本体标识 (Marking on the Low Resistor's Body)

0402 因本体太小，本体上无字码标示。

For 0402 size, no marking on the body due to the small size of the resistor

0603 尺寸的产品，以三字码标示，第一位码R 表示 10^{-3} ，后两位表示阻值的有效数字；第一位码0表示小于100毫欧产品，后两位表示阻值的有效数字。

For 0603 size, use three digitals to declare resistance. The first letter 'R' denotes 10^{-3} , The other two digitals declare resistance ; The first letter '0' means less than 100 mohm products, The other two digitals declare resistance.

0603 以上尺寸的产品，以四字码标示，第一位码R表示 10^{-3} ，后三位表示阻值的有效数字。

The size larger than 0603, use four digitals to declare resistance. The first letter 'R' denotes 10^{-3} , The other three digitals declare resistance.



$$R10 = 0R10 = 0.1\Omega$$

$$R47 = 0R47 = 0.47\Omega$$

$$R010 = R010 = 0.010\Omega$$

$$R220 = 0R22 = 0.22\Omega$$

$$R330 = 0R33 = 0.33\Omega$$

▪标准阻段 (Standard Nominal Resistance Values)

IEC-63 Nominal Resistance/Capacitance

| E1 | E3 | E6 | E12 | E24 | E96 | | | | |
|-----|-----|-----|-----|-----|-----|-----|-----|-----|-----|
| 100 | 100 | 100 | 100 | 100 | 100 | 105 | 110 | 115 | |
| | | | | 110 | 102 | 107 | 113 | 118 | |
| | | | 120 | 120 | 121 | 127 | 133 | 140 | |
| | | | | 130 | 124 | 130 | 137 | 143 | |
| | | | 150 | 150 | 150 | 147 | 154 | 162 | 169 |
| | | | | | 160 | 150 | 158 | 165 | 174 |
| | | 180 | | 180 | 178 | 187 | 196 | 205 | |
| | | | | 200 | 182 | 191 | 200 | 210 | |
| | | 220 | 220 | 220 | 220 | 215 | 226 | 237 | 249 |
| | | | | | 240 | 221 | 232 | 243 | 255 |
| | | | | 270 | 270 | 261 | 274 | 287 | 301 |
| | | | | | 300 | 267 | 280 | 294 | 309 |
| | 330 | | | 330 | 330 | 316 | 332 | 348 | 365 |
| | | | | | 360 | 324 | 340 | 357 | 374 |
| | | | 390 | 390 | 383 | 402 | 422 | 442 | |
| | | | | 430 | 392 | 412 | 432 | 453 | |
| | 470 | | 470 | 470 | 470 | 464 | 487 | 511 | 536 |
| | | | | | 510 | 475 | 499 | 523 | 549 |
| | | | | 560 | 560 | 562 | 590 | 619 | 649 |
| | | | | | 620 | 576 | 604 | 634 | 665 |
| | | 680 | | 680 | 680 | 681 | 715 | 750 | 787 |
| | | | | | 750 | 698 | 732 | 768 | 806 |
| | | | 820 | 820 | 825 | 866 | 909 | 953 | |
| | | | | 910 | 845 | 887 | 931 | 976 | |

$$E6 : \sqrt[6]{10}=1.46 \quad E12 \sqrt[12]{10}=1.21$$

E1 series resistance: 1Ω. 10Ω. 100Ω. 1000Ω. 10000Ω. 100000Ω

包装规格

Tapping Specification

Reel

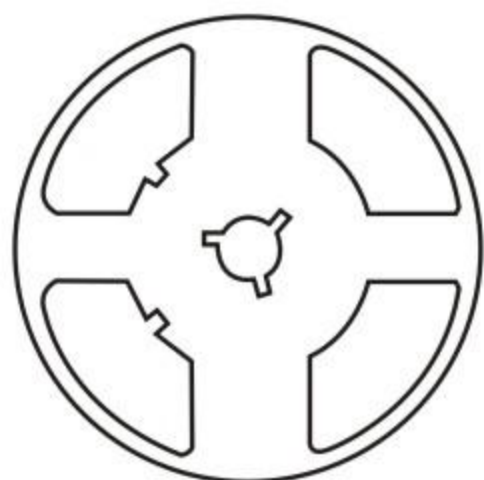

Standard Quantity per Reel
5,000 pcs/Reel

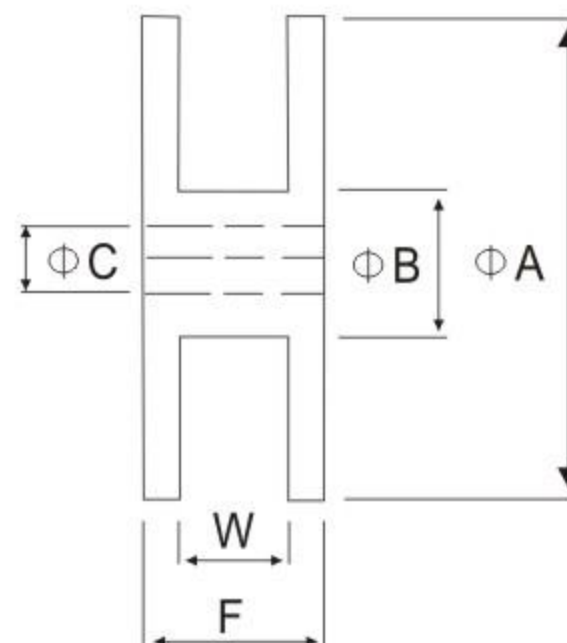

Unit: mm

■卷盘尺寸 (Reel dimension)

| Type | Size | | Unit | A | B | C | F | W |
|----------------------------------|------|-----------------------------------|------|---------|----------|----------|----------|----------|
| 0201/0402 | 7" | 10K/Reel 15K/Reel 0201 only | mm | 178±2.0 | 60.0±1.0 | 13.5±0.5 | 11.4±0.1 | 9.00±0.3 |
| 0402 | 13" | 40K/50K Reel | mm | 178±2.0 | 60.0±1.0 | 13.5±0.5 | 11.4±0.1 | 9.00±0.3 |
| 0603/0805/1206/1210 044R/064R | 7" | 5K/Reel | mm | 178±2.0 | 60.0±1.0 | 13.5±0.5 | 11.4±0.1 | 9.00±0.3 |
| 0603/0805/1206 | 10" | 10K/Reel | mm | 178±2.0 | 60.0±1.0 | 13.5±0.5 | 11.4±0.1 | 9.00±0.3 |
| 0603/0805/1206 | 13" | 20K/Reel | mm | 178±2.0 | 60.0±1.0 | 13.5±0.5 | 11.4±0.1 | 9.00±0.3 |
| 1218/1812/2010/2512 | 7" | 4K/Reel | mm | 178±2.0 | 60.0±1.0 | 13.5±0.5 | 15.4±1.0 | 13.0±0.3 |

备注 (Remark) :

(1) 0201/0402 每卷 10,000pcs

0201/0402 Quantity per Reel 10,000pcs/Reel

(2) 0603/0805/1206/1210/044R/064R 每卷 5,000pcs

0603/0805/1206/1210/044R/064R Quantity per Reel 5,000pcs/Reel

(3) 1812/2010/2512/1218 每卷 4,000pcs

1812/2010/2512/1218 Quantity per Reel 4,000pcs/Reel

■包装尺寸 (packing dimension)

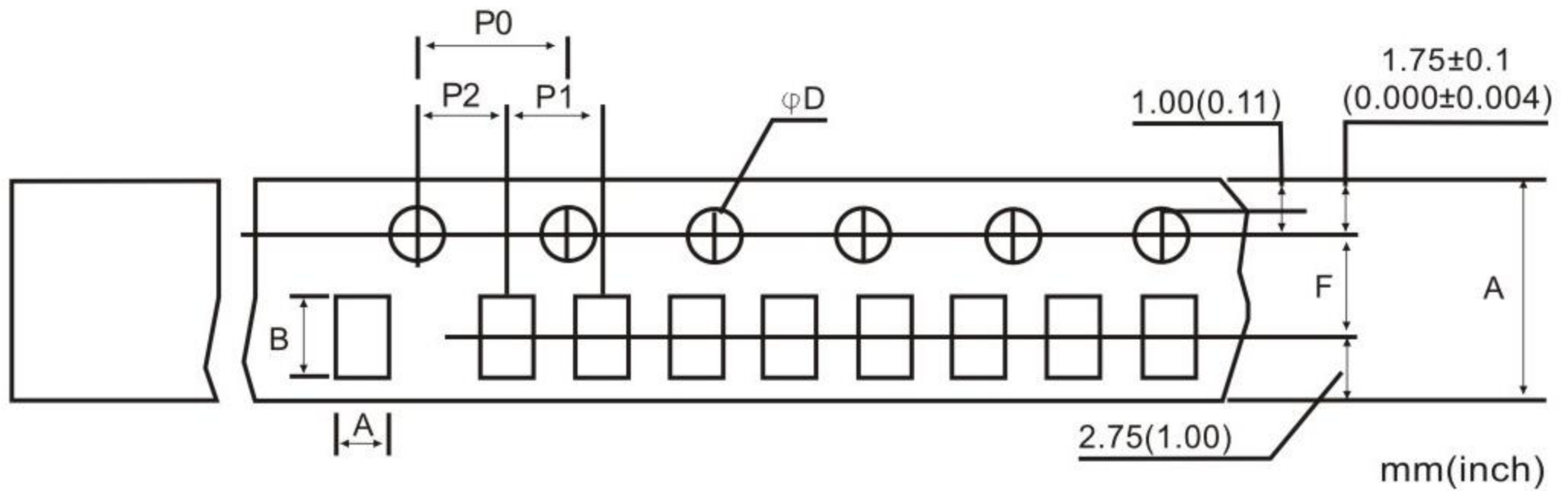

| Dimensions | A | B | D | F | P0 | P1 | P2 | W |
|------------|-----------|-----------|--|-----------|-----------|-----------|-----------|-----------|
| 0201 | 0.38±0.05 | 0.68±0.05 | 1.50± $\begin{smallmatrix} 0.1 \\ 0.0 \end{smallmatrix}$ | 3.50±0.05 | 4.00±0.10 | 2.00±0.10 | 2.00±0.05 | 8.00±0.20 |
| 0402 | 0.65±0.10 | 1.15±0.10 | 1.50± $\begin{smallmatrix} 0.1 \\ 0.0 \end{smallmatrix}$ | 3.50±0.05 | 4.00±0.10 | 2.00±0.10 | 2.00±0.05 | 8.00±0.20 |
| 0603 | 1.10±0.10 | 1.90±0.10 | 1.50± $\begin{smallmatrix} 0.1 \\ 0.0 \end{smallmatrix}$ | 3.50±0.05 | 4.00±0.10 | 4.00±0.10 | 2.00±0.05 | 8.00±0.20 |
| 0805 | 1.65±0.20 | 2.40±0.20 | 1.50± $\begin{smallmatrix} 0.1 \\ 0.0 \end{smallmatrix}$ | 3.50±0.05 | 4.00±0.10 | 4.00±0.10 | 2.00±0.05 | 8.00±0.20 |
| 044R | 1.20±0.20 | 2.20±0.20 | 1.50± $\begin{smallmatrix} 0.1 \\ 0.0 \end{smallmatrix}$ | 3.50±0.05 | 4.00±0.10 | 4.00±0.10 | 2.00±0.05 | 8.00±0.20 |
| 1206/064R | 1.90±0.20 | 3.50±0.20 | 1.50± $\begin{smallmatrix} 0.1 \\ 0.0 \end{smallmatrix}$ | 3.50±0.05 | 4.00±0.10 | 4.00±0.10 | 2.00±0.05 | 8.00±0.20 |
| 1210 | 2.80±0.20 | 3.50±0.20 | 1.50± $\begin{smallmatrix} 0.1 \\ 0.0 \end{smallmatrix}$ | 3.50±0.05 | 4.00±0.10 | 4.00±0.10 | 2.00±0.05 | 8.00±0.20 |
| 1218 | 2.80±0.20 | 4.60±0.20 | 1.50± $\begin{smallmatrix} 0.1 \\ 0.0 \end{smallmatrix}$ | 5.50±0.05 | 4.00±0.10 | 4.00±0.10 | 2.00±0.05 | 12.0±0.10 |
| 1812 | 3.30±0.20 | 4.60±0.20 | 1.50± $\begin{smallmatrix} 0.1 \\ 0.0 \end{smallmatrix}$ | 5.50±0.05 | 4.00±0.10 | 4.00±0.10 | 2.00±0.05 | 12.0±0.10 |
| 2010 | 2.90±0.10 | 5.30±0.10 | 1.50± $\begin{smallmatrix} 0.1 \\ 0.0 \end{smallmatrix}$ | 5.50±0.05 | 4.00±0.10 | 4.00±0.10 | 2.00±0.05 | 12.0±0.10 |
| 2512 | 3.40±0.10 | 6.60±0.10 | 1.50± $\begin{smallmatrix} 0.1 \\ 0.0 \end{smallmatrix}$ | 5.50±0.05 | 4.00±0.10 | 4.00±0.10 | 2.00±0.05 | 12.0±0.10 |

包装材料资料/储存资料 Packing Material Data/Storage Data

前/后导带尺寸 (Front & Back Lead Dimension)



上胶带剥离力测试 (Peel force of top cover tape)

上胶带以 200mm/分钟的速度，沿 165~180 度角的方向进行剥离，如下图所示。纸带的剥离力范围为 10g~70g；载带的剥离力范围为 30~100g。

The top cover tape is pulled at a speed of 200 mm/min with the angle between the tape during peel and the direction of unreeling maintained at 165 to 180 degree as following picture. The peel force of paper carrier tape shall be 0.1N to 0.7N(10 to 70 g), the peel force of plastic carrier tape shall be 0.3N to 1N (30 to 100 g)



储存资料 (Storage Data)

Storage time at the environment temp: $25\pm 5^{\circ}\text{C}$ & humidity: $60\pm 20\%$ is valid for two year from the date of delivery.

储存效期：在环境温度： $25\pm 5^{\circ}\text{C}$ ，湿度： $60\pm 20\%$ ，自交付日起二年

焊接 soldering

■ 建议回流焊曲线 (Recommend reflow soldering profile)



■ 建议波峰焊曲线 (Recommend wave soldering profile)



■ 手工焊温度 (hand soldering temperature)

烙铁温度 $350 \pm 10^\circ\text{C}$ 3 秒之内，避免烙铁接触电阻本体

The iron temperature is $350 \pm 10^\circ\text{C}$, hand soldering time less than 3S. Avoid solder iron tip direct touch the components body

安徽省富捷电子科技有限公司

安徽省马鞍山市郑蒲港新区金蒲电子信息产业园

www.fojan.cn

X-ON Electronics

Largest Supplier of Electrical and Electronic Components

Click to view similar products for [Thick Film Resistors - SMD category:](#)

Click to view products by [FOJAN Electronics manufacturer:](#)

Other Similar products are found below :

[CR-05FL7--150R](#) [CR-05FL7--698K](#) [CR-12JP4--680R](#) [CRCW04021K20FKEE](#) [CRCW04028R20JNEE](#) [CRCW06032K10FKEC](#)

[CRCW06036K80FKEE](#) [M55342K03B499DRS6](#) [M55342K06B14E0RS6](#) [M55342K06B1E78RS3](#) [M55342K06B6E19RWL](#)

[M55342K06B6E81RS3](#) [M55342K09B5D62RS6](#) [M55342M05B200DRWB](#) [M55342M06B26E7RS3](#) [M55342M06B4K70MS3](#)

[742C083750JTR](#) [MCR01MZPF1202](#) [MCR01MZPF1601](#) [MCR01MZPF1800](#) [MCR01MZPF6201](#) [MCR01MZPF9102](#) [MCR01MZPJ121](#)

[MCR01MZPJ125](#) [MCR01MZPJ751](#) [MCR03EZHJ103](#) [MCR03EZPFX2004](#) [MCR03EZPJ270](#) [MCR03EZPJ821](#) [MCR10EZPF1102](#)

[MCR10EZPF2700](#) [MCR18EZPJ330](#) [RC1005F1152CS](#) [RC1005F1372CS](#) [RC1005F1912CS](#) [RC1005F2052CS](#) [RC1005F3011CS](#)

[RC1005F471CS](#) [RC1005F4751CS](#) [RC1005F5621CS](#) [RC1005F6041CS](#) [RC1005J121CS](#) [RC1005J122CS](#) [RC1005J154CS](#) [RC1005J180CS](#)

[RC1005J181CS](#) [RC1005J202CS](#) [RC1005J391CS](#) [RC1005J560CS](#) [RC1005J683CS](#)