

常规系列厚膜晶片电阻  
Thick Film Chip Resistor  
FRC Series



■应用 ( Application )

- Entertainment : Stereo, TV tuners , Tape recorder
- Appliance: Air conditioner, Refrigerator
- Computer & relative products : Main board, PDA
- Communication equipment: Cell phone, Fax machine
- Power equipment: Power supply , II Lumination equipment
- Measuring instrument: Electric meter, Navigation equipment

- 娱乐：立体声、电视调谐器、录音机
- 电器：空调、冰箱
- 电脑及相关产品：主板、PDA
- 通讯设备：手机、传真机
- 电源设备：电源、二级照明设备
- 测量仪器：电表、导航设备

■特点 ( Features )

- small size and light weight
- Reliability, high quality

- 体积小、重量轻
- 可靠性，高质量

■产品料号 ( Parts Number Explanation )

示例 ( Example ) : FRC1206F1001 TSD

| F<br>公司名     | R<br>产品别   | C<br>功能别  | 1206<br>尺寸   | F<br>公差   | 1001<br>字码  | T<br>包装别   | S<br>端电极                   | D<br>特殊码            |
|--------------|--|---|--|---|---|--|----------------------------|---------------------|
| FOJAN        | R:Resistor<br>C:Capacitor<br>L:Inductor<br>D:Diode<br>A:Audion | C:Normal<br>P:Hi-Power<br>L:Lowohmic<br>A:Array<br>S:Surge<br>H:Hi-Precision<br>V:Hi-Voltage<br>Q:Auto-motive<br>R:Anti-sulfur<br>M:Metal<br>D: LED | 0201<br>0402<br>0603<br>0805<br>1206<br>1210<br>1218<br>1812<br>2010<br>2512 | B:±0.1%<br>C:±0.25%<br>D:±0.5%<br>F:±1%<br>J:±5%<br>P: Jumper | ±5%:E24<br>3-digits+blank<br>102=1KΩ<br>1R0=1Ω<br><br>±1%&Below :<br>E24+E96 :<br>4-digits<br>1001=1KΩ<br>1R00=1Ω | T: 7 inch reel<br>Q:10 inch reel<br>R:13 inch reel<br>B:Bulk | S : Sn<br>C : Cu<br>A : Au | N:Normal<br>D : LED |
| Company code | Type code  | Functional code   | Size code  | Tolerance code  | Resistance code   | Packaging code   | Termination code           | Special Case        |

■尺寸 (Dimension)

| 尺寸<br>dimension |  |           |           |           |           |
|-----------------|--|-----------|-----------|-----------|-----------|
|                 | 单位 (unit) : mm   |           |           |           |           |
| 型别 ( Type )     | L  | W         | H         | T1        | T2        |
| 0201            | 0.60±0.03  | 0.30±0.03 | 0.23±0.03 | 0.10±0.05 | 0.15±0.05 |
| 0402            | 1.00±0.05  | 0.50±0.05 | 0.35±0.05 | 0.20±0.10 | 0.25±0.10 |
| 0603            | 1.60±0.10  | 0.80±0.10 | 0.45±0.10 | 0.25±0.15 | 0.25±0.15 |
| 0805            | 2.00±0.10  | 1.25±0.10 | 0.50±0.10 | 0.35±0.20 | 0.35±0.20 |
| 1206            | 3.10±0.10  | 1.60±0.10 | 0.55±0.10 | 0.45±0.20 | 0.40±0.20 |
| 1210            | 3.10±0.10  | 2.60±0.15 | 0.55±0.10 | 0.45±0.15 | 0.50±0.20 |
| 1218            | 3.10±0.10  | 4.60±0.10 | 0.55±0.10 | 0.45±0.20 | 0.40±0.20 |
| 1812            | 4.50±0.20  | 3.10±0.20 | 0.55±0.10 | 0.55±0.20 | 0.70±0.20 |
| 2010            | 5.00±0.10  | 2.50±0.15 | 0.55±0.10 | 0.45±0.15 | 0.50±0.20 |
| 2512            | 6.35±0.10  | 3.10±0.15 | 0.55±0.10 | 0.60±0.20 | 0.50±0.20 |

■电阻结构 ( Construction )

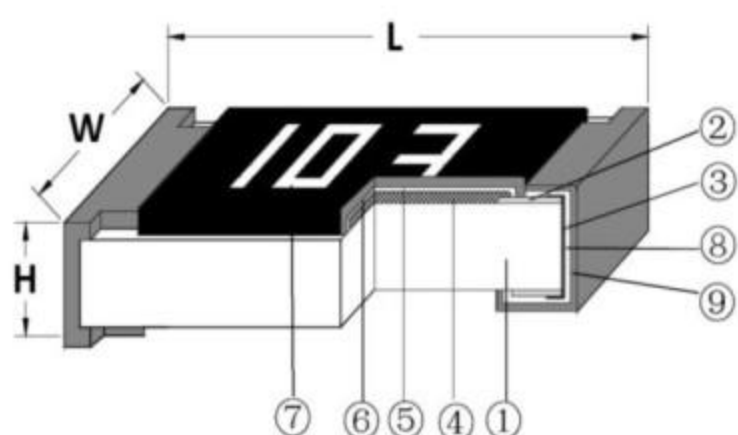

| NO. | 结构<br>construction             | 主要材料<br>Major material                  |
|-----|--------------------------------|---|
| 1   | 陶瓷基板<br>Ceramic substrate      | 三氧化二铝<br>Al <sub>2</sub> O <sub>3</sub> |
| 2   | 银电极<br>Conductive layer        | 银<br>Ag                                 |
| 3   | 侧电极<br>Side conductive layer   | 镍铬合金<br>NiCr                            |
| 4   | 阻体层<br>Resistive layer         | 氧化钌+玻璃<br>RuO <sub>2</sub> + glass      |
| 5   | 内保护层<br>Inner protective layer | 玻璃<br>Glass                             |
| 6   | 外保护层<br>Outer Protective layer | 环氧树脂<br>Epoxy                           |
| 7   | 文字<br>Marking                  | 环氧树脂<br>Epoxy                           |
| 8   | 镍电极<br>Ni plating layer        | 镍<br>Ni                                 |
| 9   | 锡电极<br>Sn plating layer        | 锡<br>Matte Tin                          |



■功率衰减曲线 ( Derating Curve )

| 使用温度范围  | -55°C~+125°C(0201)               | -55°C~+155°C                     |
|---------|----------------------------------|----------------------------------|
| 说明      | 周围温度若超过70°C至125°C之间,功率可照下图曲线予以修订 | 周围温度若超过70°C至155°C之间,功率可照下图曲线予以修订 |
| 功率衰减曲线图 |                                  |                                  |

■电气特性 ( Electrical characteristics )

| 型别 Type                                     | 0201  | 0402  | 0603  | 0805  | 1206  | 1210  | 1218  | 1812  | 2010  | 2512  |
|---|-------|-------|-------|-------|-------|-------|-------|-------|-------|-------|
| 绝缘耐压<br>Dielectric Withstanding Voltage     | -     | 100V  | 100V  | 300V  | 500V  | 500V  | 500V  | 500V  | 500V  | 500V  |
| 零欧姆阻值 ±1%<br>Resistance Value of Jumper ±1% | -     | <30mΩ | <30mΩ | <30mΩ | <30mΩ | <30mΩ | <30mΩ | <30mΩ | <30mΩ | <30mΩ |
| 零欧姆阻值 ±5%<br>Resistance Value of Jumper ±5% | <50mΩ | <50mΩ | <50mΩ | <50mΩ | <50mΩ | <50mΩ | <50mΩ | <50mΩ | <50mΩ | <50mΩ |
| 零欧姆额定电流<br>Rated Current of Jumper          | 0.5A  | 1A    | 1A    | 2A    | 2A    | 2A    | 6A    | 2A    | 2A    | 2A    |
| 零欧姆电阻最大电流<br>Max Current of Jumper          | 1A    | 2A    | 2A    | 5A    | 10A   | 10A   | 10A   | 10A   | 10A   | 10A   |

■电性规格 ( Standard Electrical Specifications )

| 型别<br>Type | 额定功率<br>( PowerRating<br>at 70℃ ) | 最高<br>工作电压<br>Max. RCWV | 最大过负荷电压<br>Max. Overload Voltage | T.C.R.<br>(PPM/°C) | 阻值范围<br>Resistance Range |
|------------|-----------------------------------|-------------------------|----------------------------------|--------------------|--------------------------|
| 0201       | 1/20W                             | 25V                     | 50V                              | ± 400              | 1Ω~10Ω                   |
|            |                                   |                         |                                  | ± 200              | 10Ω~10MΩ                 |
| 0402       | 1/16W                             | 50V                     | 100V                             | ±200               | 1Ω~10Ω                   |
|            |                                   |                         |                                  | ± 100              | 10MΩ~100MΩ               |
| 0603       | 1/10W                             | 75V                     | 150V                             | ± 200              | 10Ω~10MΩ                 |
|            |                                   |                         |                                  | ± 100              | 1Ω~10Ω                   |
| 0805       | 1/8W                              | 150V                    | 300V                             | ± 200              | 10MΩ~100MΩ               |
|            |                                   |                         |                                  | ± 100              | 1Ω~10Ω                   |
| 1206       | 1/4W                              | 200V                    | 400V                             | ± 200              | 10Ω~10MΩ                 |
|            |                                   |                         |                                  | ± 100              | 1Ω~10Ω                   |
| 1210       | 1/3W                              | 200V                    | 400V                             | ± 200              | 10MΩ~100MΩ               |
|            |                                   |                         |                                  | ± 100              | 1Ω~10Ω                   |
| 1218       | 1W                                | 200V                    | 500V                             | ± 200              | 10Ω~1MΩ                  |
|            |                                   |                         |                                  | ± 100              | 1Ω~10Ω                   |
| 1812       | 3/4W                              | 200V                    | 400V                             | ± 200              | 10MΩ~100MΩ               |
|            |                                   |                         |                                  | ± 100              | 1Ω~10Ω                   |
| 2010       | 3/4W                              | 200V                    | 400V                             | ± 200              | 10Ω~10MΩ                 |
|            |                                   |                         |                                  | ± 100              | 10MΩ~100MΩ               |
| 2512       | 1W                                | 200V                    | 400V                             | ± 200              | 1Ω~10Ω                   |
|            |                                   |                         |                                  | ± 100              | 10MΩ~100MΩ               |

如有非标准品的需求,请联系我们的业务部门 For non-standard parts, please contact our sales dept.







■性能 ( Performance Specifications )

| 内容<br>Item                                    | 测试方法<br>Test Methods | 测试条件<br>Test Conditions   | 规格<br>Specification   |
|---|----------------------|---|---|
| 温度系数<br>Temperature<br>Coefficient            | JIS C 5201 4.8       | $TCR = (R - R_0) / (t - t_0) R_0 \times 10^6$ ( ppm )<br>R <sub>0</sub> 电阻在室温下的阻值(resistance at room temperature)<br>R 电阻在 125℃或-55℃下的阻值(resistance at 125℃ or -55℃)<br>t <sub>0</sub> 室温(room temperature)<br>t 测试温度 ( test temperature 125℃ or -55℃ ) | 0201 规格 :<br>1Ω ≤ R ≤ 10Ω:<br>±400 PPM/℃<br>10Ω < R ≤ 10MΩ:<br>±200 PPM/℃<br>0402~2512 规格 :<br>1Ω ≤ R ≤ 10Ω:<br>±200 PPM/℃<br>10Ω < R ≤ 10MΩ:<br>±100 PPM/℃<br>10MΩ < R ≤ 100MΩ:<br>±200PPM/℃ |
| 短时间过负荷<br>Short-time<br>overload              | JIS C 5201 4.13      | 加载 2.5 倍的额定电压，时间 5 秒后测量试验前后的阻值变化率。<br>Applied 2.5 times of rated voltage for 5 second.<br>Measure the variation of resistance.  | ±(1.00% +0.05Ω)   |
| 焊锡性<br>Solderability                          | JIS C 5201 4.17      | 沾助焊剂后浸入锡炉，锡炉温度 245±5℃，时间 3±0.5 秒。<br>Dip the terminal in a flux and then dip into a soldering bath at 245±5℃ for 3±0.5sec.  | > 95%面积上锡<br>( > 95% coverage)  |
| 抗焊锡热<br>Resistto soldering<br>heat            | JIS C 5201 4.18      | 沾助焊剂后浸入锡炉，锡炉温度 260±5℃，时间 10±0.5 秒，测量试验前后的阻值变化率。<br>Dip the terminal in a flux and then dip into a soldering bath at 260±5℃ for 10±0.5sec.<br>Measure the variation of resistance.   | ±(1.00% +0.05Ω)   |
| 绝缘电阻<br>Insulation<br>resistance              | JIS C 5201 4.6       | 电阻本体上加载绝缘耐压 60±5 秒后 测量绝缘阻抗。<br>Applied the dielectric withstanding voltage on the center of body for 60±5seconds. Then measure insulation resistance.   | >10GΩ   |
| 绝缘耐压<br>Dielectric<br>withstanding<br>voltage | JIS C 5201 4.7       | 电阻本体上加载绝缘耐压 60±5 秒。<br>Applied the dielectric withstanding voltage on the center of body for60±5seconds.  | 无击穿、飞弧及可见机械性损伤<br>No evidence of flashover, mechanical damage arcing or insulation breakdown  |

| 内容<br>Item                     | 测试方法<br>Test Methods      | 测试条件<br>Test Conditions  | 规格<br>Specification |
|--------------------------------|---------------------------|--|---------------------|
| 端子弯曲<br>Terminalbending        | JIS C 5201 4.33           | 电阻焊接在测试板上进行弯折,弯折保持时间<br>20±1 秒,1206(含) 以下的尺寸弯曲 5+0.2/0 mm;<br>1206 以上的尺寸弯曲 2+0.2/0 mm; 量测试验前<br>后阻值变化率<br>Specimen shall be mounted on test board, then<br>bend the board and maintained for 20±1s. the<br>distance of bending is 5+0.2/0 mm for resistors<br>which size no larger than 1206 or 2+0.2/0 mm<br>which size larger than 1206. Measure the<br>variation of resistance. | ±(1.00% +0.05Ω)     |
| 温度循环<br>Temperature<br>Cycling | JIS C 5201 4.19           | 电阻放入温度循环机中,温度 155±2℃至<br>-55±3℃,共 5 个循环。量测试验前后阻值变化率。<br>Put specimen in a chamber which temperature<br>can be changed to 155±2℃ or -55±3℃,<br>repeated 5 times. Measure the variation of<br>resistance.  | ±(2.00% +0.05Ω)     |
| 耐湿特性<br>Humidity               | JIS C 5201 4.24           | 电阻放入恒温恒湿箱,温度 40±2℃,湿度<br>90~95 %RH;通电额定电压 1.5 小时,断电 0.5 小<br>时;重复通断电至试验时间 1000 <sup>+48/-0</sup> 小时。量<br>测试验前后阻值变化率。<br>Put the specimen in a chamber at 40±2℃<br>temperature and 90~95% relative humidity, then<br>applied rated voltage for 1.5H and rested for<br>0.5H repeatedly till total test time is 1000 <sup>+48/-0</sup><br>H. Measure the variation of resistance.     | ±(2.00% +0.05Ω)     |
| 负荷寿命<br>Load life              | JIS C 5201 4.25.1         | 电阻放入恒温箱中,温度 70±2℃, ON<br>TIME:1.5H ,OFF TIME:0.5H 通电额定电压 1000 <sup>+24/-0</sup><br>小时,量测试验前后阻值变化率。<br>Put the specimen in a chamber at 70±2℃<br>temperature, ON TIME:1.5H , OFF TIME:0.5H ,<br>and applied rated voltage for 1000 <sup>+24/-0</sup> H.<br>Measure the variation of resistance.   | ±(2.00% +0.05Ω)     |
| 温湿循环<br>Moisture<br>resistance | MIL-STD-202<br>METHOD 106 | 25℃~65℃,90~100%RH, 2.5 小时; 65℃<br>90~100%RH, 3 小时;<br>65℃~25℃,80~100%RH,2.5 小时,10 个循环,试<br>验结束 24±4 小时后进行测试。<br>25℃~65℃,90~100%RH, 2.5H; 65℃<br>90~100%RH, 3H; 65℃~25℃<br>80~100%RH, 2.5H, 10 cycles, Measurement at<br>24±4 hours after test conclusion.  | ±(2.00% +0.05Ω)     |



## 电阻本体字码标识 Marking on the Resistor's Body

|   |  |  |
|---|--|--|
| <p>0201 及 0402 因本体太小，本体上无字码标示<br/>For 0201 and 0402 size, no marking on the body due to the small size of the resistor</p> <p>公差±5%的产品，以三字码标示，前两位表示阻值的有效数字，最后一位表示 10 的乘幂<br/>±5% tolerance product: the marking is 3 digits, the first 2 digits are significant figures of resistance value and the 3rd one denotes the power number of 10, (10X)</p> <p>±0.5%, ±1%, ±2%的产品，以四字码标示，前三位表示阻值的有效数字，最后一位表示 10 的乘幂<br/>±0.5%, ±1%, ±2% tolerance product: the marking is 4 digits, the first 3 digits are significant figures of resistance value and the 4th one denotes the power number of 10, (10X)</p> <p>0603 ±1% E96 系列的标准阻值，因电阻本体太小，采用三位代码标示。<br/>Standard E96 series values of 0603 ±1%: due to the small size of the resistor's body, use 3digits code to indicate the resistance value.</p> | <br><br><br><br><br><br> | <p>472=47×10<sup>2</sup>=4.7KΩ</p> <hr/> <p>10Ω以下标示：5R6=5.6Ω<br/>Below 10Ω: 5R6=5.6Ω</p> <hr/> <p>4992=499×10<sup>2</sup>=49.9KΩ</p> <hr/> <p>100Ω以下标示：6R81=6.81Ω<br/>Below 100Ω: 6R81=6.81Ω</p> |
|---|--|--|

### 用于 0603±1%标记的标准 E96 系列电阻值代码 Standard E96 Series Resistance Value Code for 0603 ±1% Marking

| 代码<br>Code | 阻值<br>Value | 代码<br>Code | 阻值<br>Value | 代码<br>Code | 阻值<br>Value | 代码<br>Code | 阻值<br>Value | 代码<br>Code | 阻值<br>Value | 代码<br>Code | 阻值<br>Value |
|------------|-------------|------------|-------------|------------|-------------|------------|-------------|------------|-------------|------------|-------------|
| 01         | 100         | 17         | 147         | 33         | 215         | 49         | 316         | 65         | 464         | 81         | 681         |
| 02         | 102         | 18         | 150         | 34         | 221         | 50         | 324         | 66         | 475         | 82         | 698         |
| 03         | 105         | 19         | 154         | 35         | 226         | 51         | 332         | 67         | 487         | 83         | 715         |
| 04         | 107         | 20         | 158         | 36         | 223         | 52         | 340         | 68         | 499         | 84         | 732         |
| 05         | 110         | 21         | 162         | 37         | 237         | 53         | 348         | 69         | 511         | 85         | 750         |
| 06         | 113         | 22         | 165         | 38         | 243         | 54         | 357         | 70         | 523         | 86         | 768         |
| 07         | 115         | 23         | 169         | 39         | 249         | 55         | 365         | 71         | 536         | 87         | 787         |
| 08         | 118         | 24         | 174         | 40         | 255         | 56         | 374         | 72         | 549         | 88         | 806         |
| 09         | 121         | 25         | 178         | 41         | 261         | 57         | 383         | 73         | 562         | 89         | 825         |
| 10         | 124         | 26         | 182         | 42         | 267         | 58         | 392         | 74         | 576         | 90         | 845         |
| 11         | 127         | 27         | 187         | 43         | 274         | 59         | 402         | 75         | 590         | 91         | 866         |
| 12         | 130         | 28         | 191         | 44         | 280         | 60         | 412         | 76         | 604         | 92         | 887         |
| 13         | 133         | 29         | 196         | 45         | 287         | 61         | 422         | 77         | 619         | 93         | 909         |
| 14         | 137         | 30         | 200         | 46         | 294         | 62         | 432         | 78         | 634         | 94         | 931         |
| 15         | 140         | 31         | 205         | 47         | 301         | 63         | 442         | 79         | 649         | 95         | 953         |
| 16         | 143         | 32         | 210         | 48         | 309         | 64         | 453         | 80         | 665         | 96         | 976         |



■0603±1%标记的倍增码：Multiplier Code for 0603 ±1% Marking:

| 代码 Code       | Y         | X         | A      | B      | C      | D      | E      | F      |
|---------------|-----------|-----------|--------|--------|--------|--------|--------|--------|
| 指数 Multiplier | $10^{-2}$ | $10^{-1}$ | $10^0$ | $10^1$ | $10^2$ | $10^3$ | $10^4$ | $10^5$ |

阻值标示如下(So the resistance value are marked as the following examples)



$$10D=124 \times 10^3=124K\Omega$$



$$38Y=243 \times 10^{-2}=2.43\Omega$$

0603 ±1%的产品，在标准 E24 系列中，但不属于 E96 系列，标示与 5%的字码相同，但是在中间字码下加一条线 ( Standard E24 and not belong to E96 series values of 0603 ±1%, the marking is the same as 5% tolerance but marking as underline )



$$33\underline{1}=33 \times 10^1=330\Omega$$



$$56\underline{0}=56 \times 10^0=56\Omega$$

■FRL 系列低阻本体标识 ( Marking on the Low Resistor's Body )

|  |  |                         |
|--|--|-------------------------|
| <p>0402 因本体太小，本体上无字码标示。<br/>For 0402 size, no marking on the body due to the small size of the resistor</p>  |  | $R10=0R10=0.1\Omega$    |
| <p>0603 尺寸的产品，以三字码标示，第一位码R 表示<math>10^{-3}</math>，后两位表示阻值的有效数字；第一位码0表示小于100毫欧产品，后两位表示阻值的有效数字。<br/>For 0603 size, use three digitals to declare resistance. The first letter 'R'denotes <math>10^{-3}</math>, The other two digitals declare resistance ; The first letter '0'means less than 100 mohm products, The other two digitals declare resistance.</p> |  | $R47=0R47=0.47\Omega$   |
| <p>0603 以上尺寸的产品，以四字码标示，第一位码R表示<math>10^{-3}</math>，后三位表示阻值的有效数字。<br/>The size larger than 0603, use four digitals to declare resistance. The first letter 'R'denotes <math>10^{-3}</math>, The other three digitals declare resistance.</p>  |  | $R010=R010=0.010\Omega$ |
|  |  | $R220=0R22=0.22\Omega$  |
|  |  | $R330=0R33=0.33\Omega$  |



### ▪标准阻段 ( Standard Nominal Resistance Values )

IEC-63 Nominal Resistance/Capacitance

| E1  | E3  | E6  | E12 | E24 | E96 |     |     |     |     |
|-----|-----|-----|-----|-----|-----|-----|-----|-----|-----|
| 100 | 100 | 100 | 100 | 100 | 100 | 105 | 110 | 115 |     |
|     |     |     |     | 110 | 102 | 107 | 113 | 118 |     |
|     |     |     | 120 | 120 | 121 | 127 | 133 | 140 |     |
|     |     |     |     | 130 | 124 | 130 | 137 | 143 |     |
|     |     |     | 150 | 150 | 150 | 147 | 154 | 162 | 169 |
|     |     |     |     |     | 160 | 150 | 158 | 165 | 174 |
|     |     | 180 |     | 180 | 178 | 187 | 196 | 205 |     |
|     |     |     |     | 200 | 182 | 191 | 200 | 210 |     |
|     |     | 220 | 220 | 220 | 220 | 215 | 226 | 237 | 249 |
|     |     |     |     |     | 240 | 221 | 232 | 243 | 255 |
|     |     |     |     | 270 | 270 | 261 | 274 | 287 | 301 |
|     |     |     |     |     | 300 | 267 | 280 | 294 | 309 |
|     | 330 |     |     | 330 | 330 | 316 | 332 | 348 | 365 |
|     |     |     |     |     | 360 | 324 | 340 | 357 | 374 |
|     |     |     | 390 | 390 | 383 | 402 | 422 | 442 |     |
|     |     |     |     | 430 | 392 | 412 | 432 | 453 |     |
|     | 470 |     | 470 | 470 | 470 | 464 | 487 | 511 | 536 |
|     |     |     |     |     | 510 | 475 | 499 | 523 | 549 |
|     |     |     |     | 560 | 560 | 562 | 590 | 619 | 649 |
|     |     |     |     |     | 620 | 576 | 604 | 634 | 665 |
|     |     | 680 |     | 680 | 680 | 681 | 715 | 750 | 787 |
|     |     |     |     |     | 750 | 698 | 732 | 768 | 806 |
|     |     |     | 820 | 820 | 825 | 866 | 909 | 953 |     |
|     |     |     |     | 910 | 845 | 887 | 931 | 976 |     |

$E6 : \sqrt[6]{10}=1.46$      $E12 \sqrt[12]{10}=1.21$

E1 series resistance: 1Ω. 10Ω. 100Ω. 1000Ω. 10000Ω. 100000Ω

包装规格

Tapping Specification

Reel



Standard Quantity per Reel  
5,000 pcs/Reel



Unit: mm

■卷盘尺寸 ( Reel dimension )

| Type                             | Size |                                   | Unit | A       | B        | C        | F        | W        |
|----------------------------------|------|-----------------------------------|------|---------|----------|----------|----------|----------|
| 0201/0402                        | 7"   | 10K/Reel<br>15K/Reel<br>0201 only | mm   | 178±2.0 | 60.0±1.0 | 13.5±0.5 | 11.4±0.1 | 9.00±0.3 |
| 0402                             | 13"  | 40K/50K<br>Reel                   | mm   | 178±2.0 | 60.0±1.0 | 13.5±0.5 | 11.4±0.1 | 9.00±0.3 |
| 0603/0805/1206/1210<br>044R/064R | 7"   | 5K/Reel                           | mm   | 178±2.0 | 60.0±1.0 | 13.5±0.5 | 11.4±0.1 | 9.00±0.3 |
| 0603/0805/1206                   | 10"  | 10K/Reel                          | mm   | 178±2.0 | 60.0±1.0 | 13.5±0.5 | 11.4±0.1 | 9.00±0.3 |
| 0603/0805/1206                   | 13"  | 20K/Reel                          | mm   | 178±2.0 | 60.0±1.0 | 13.5±0.5 | 11.4±0.1 | 9.00±0.3 |
| 1218/1812/2010/2512              | 7"   | 4K/Reel                           | mm   | 178±2.0 | 60.0±1.0 | 13.5±0.5 | 15.4±1.0 | 13.0±0.3 |

备注 ( Remark ) :

- (1) 0201/0402 每卷 10,000pcs  
0201/0402 Quantity per Reel 10,000pcs/Reel
- (2) 0603/0805/1206/1210/044R/064R 每卷 5,000pcs  
0603/0805/1206/1210/044R/064R Quantity per Reel 5,000pcs/Reel
- (3) 1812/2010/2512/1218 每卷 4,000pcs  
1812/2010/2512/1218 Quantity per Reel 4,000pcs/Reel



▪包装尺寸 ( packing dimension )

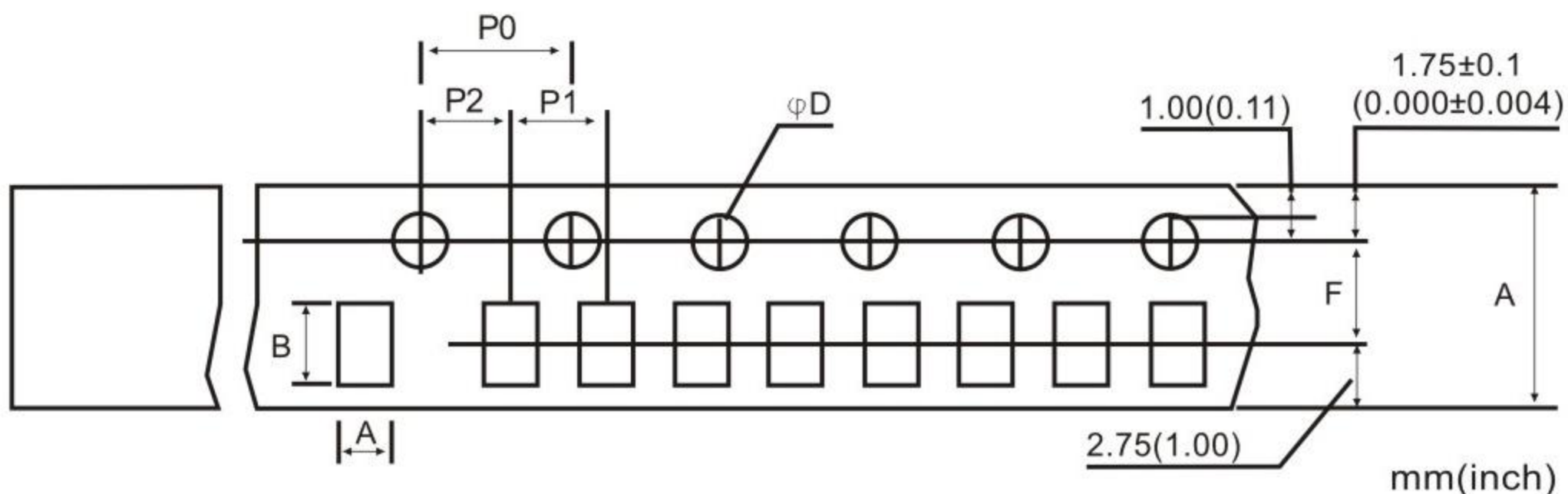

| Dimensions | A         | B         | D                                     | F         | P0        | P1        | P2        | W         |
|------------|-----------|-----------|---------------------------------------|-----------|-----------|-----------|-----------|-----------|
| 0201       | 0.38±0.05 | 0.68±0.05 | 1.50± <sup>0.1</sup> / <sub>0.0</sub> | 3.50±0.05 | 4.00±0.10 | 2.00±0.10 | 2.00±0.05 | 8.00±0.20 |
| 0402       | 0.65±0.10 | 1.15±0.10 | 1.50± <sup>0.1</sup> / <sub>0.0</sub> | 3.50±0.05 | 4.00±0.10 | 2.00±0.10 | 2.00±0.05 | 8.00±0.20 |
| 0603       | 1.10±0.10 | 1.90±0.10 | 1.50± <sup>0.1</sup> / <sub>0.0</sub> | 3.50±0.05 | 4.00±0.10 | 4.00±0.10 | 2.00±0.05 | 8.00±0.20 |
| 0805       | 1.65±0.20 | 2.40±0.20 | 1.50± <sup>0.1</sup> / <sub>0.0</sub> | 3.50±0.05 | 4.00±0.10 | 4.00±0.10 | 2.00±0.05 | 8.00±0.20 |
| 044R       | 1.20±0.20 | 2.20±0.20 | 1.50± <sup>0.1</sup> / <sub>0.0</sub> | 3.50±0.05 | 4.00±0.10 | 4.00±0.10 | 2.00±0.05 | 8.00±0.20 |
| 1206/064R  | 1.90±0.20 | 3.50±0.20 | 1.50± <sup>0.1</sup> / <sub>0.0</sub> | 3.50±0.05 | 4.00±0.10 | 4.00±0.10 | 2.00±0.05 | 8.00±0.20 |
| 1210       | 2.80±0.20 | 3.50±0.20 | 1.50± <sup>0.1</sup> / <sub>0.0</sub> | 3.50±0.05 | 4.00±0.10 | 4.00±0.10 | 2.00±0.05 | 8.00±0.20 |
| 1218       | 2.80±0.20 | 4.60±0.20 | 1.50± <sup>0.1</sup> / <sub>0.0</sub> | 5.50±0.05 | 4.00±0.10 | 4.00±0.10 | 2.00±0.05 | 12.0±0.10 |
| 1812       | 3.30±0.20 | 4.60±0.20 | 1.50± <sup>0.1</sup> / <sub>0.0</sub> | 5.50±0.05 | 4.00±0.10 | 4.00±0.10 | 2.00±0.05 | 12.0±0.10 |
| 2010       | 2.90±0.10 | 5.30±0.10 | 1.50± <sup>0.1</sup> / <sub>0.0</sub> | 5.50±0.05 | 4.00±0.10 | 4.00±0.10 | 2.00±0.05 | 12.0±0.10 |
| 2512       | 3.40±0.10 | 6.60±0.10 | 1.50± <sup>0.1</sup> / <sub>0.0</sub> | 5.50±0.05 | 4.00±0.10 | 4.00±0.10 | 2.00±0.05 | 12.0±0.10 |

包装材料资料/储存资料  
Packing Material Data/Storage Data

▪前/后导带尺寸 (Front & Back Lead Dimension )

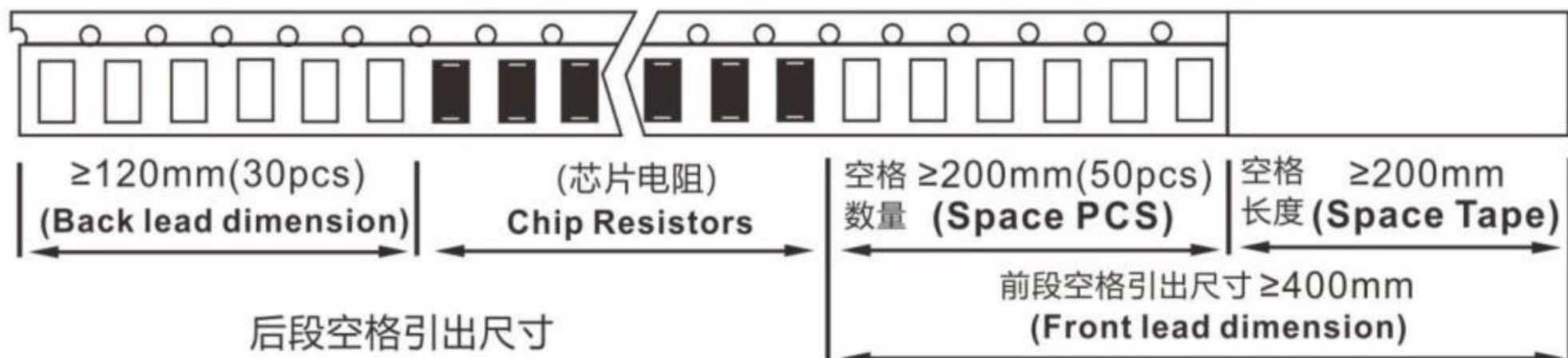

▪上胶带剥离力测试 (Peel force of top cover tape )

上胶带以 200mm/分钟的速度，沿 165~180 度角的方向进行剥离，如下图所示。纸带的剥离力范围为 10g~70g；载带的剥离力范围为 30~100g。

The top cover tape is pulled at a speed of 200 mm/min with the angle between the tape during peel and the direction of unreeling maintained at 165 to 180 degree as following picture. The peel force of paper carrier tape shall be 0.1N to 0.7N(10 to 70 g), the peel force of plastic carrier tape shall be 0.3N to 1N (30 to 100 g)

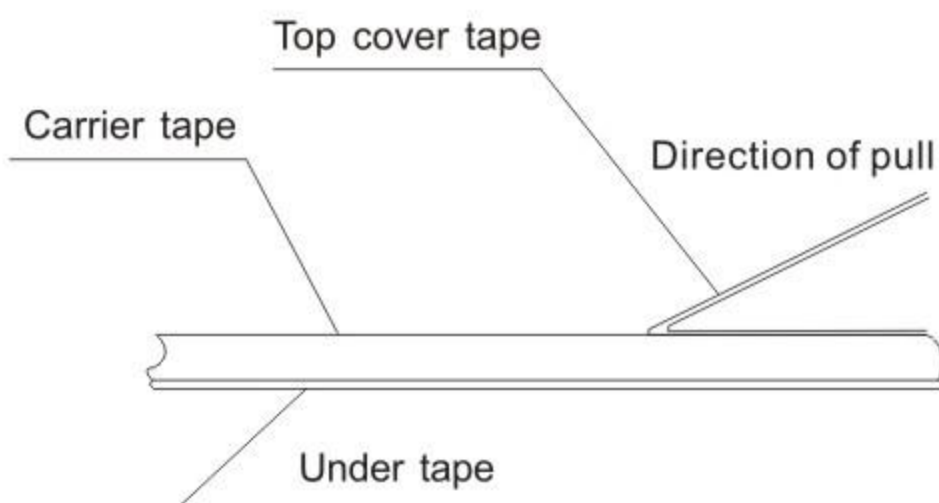

▪储存资料 (Storage Data )

Storage time at the environment temp:  $25\pm 5^\circ\text{C}$  & humidity:  $60\pm 20\%$  is valid for two year from the date of delivery.

储存效期：在环境温度： $25\pm 5^\circ\text{C}$ ，湿度： $60\pm 20\%$ ，自交付日起二年



## 焊接 soldering

### ■ 建议回流焊曲线 ( Recommend reflow soldering profile )

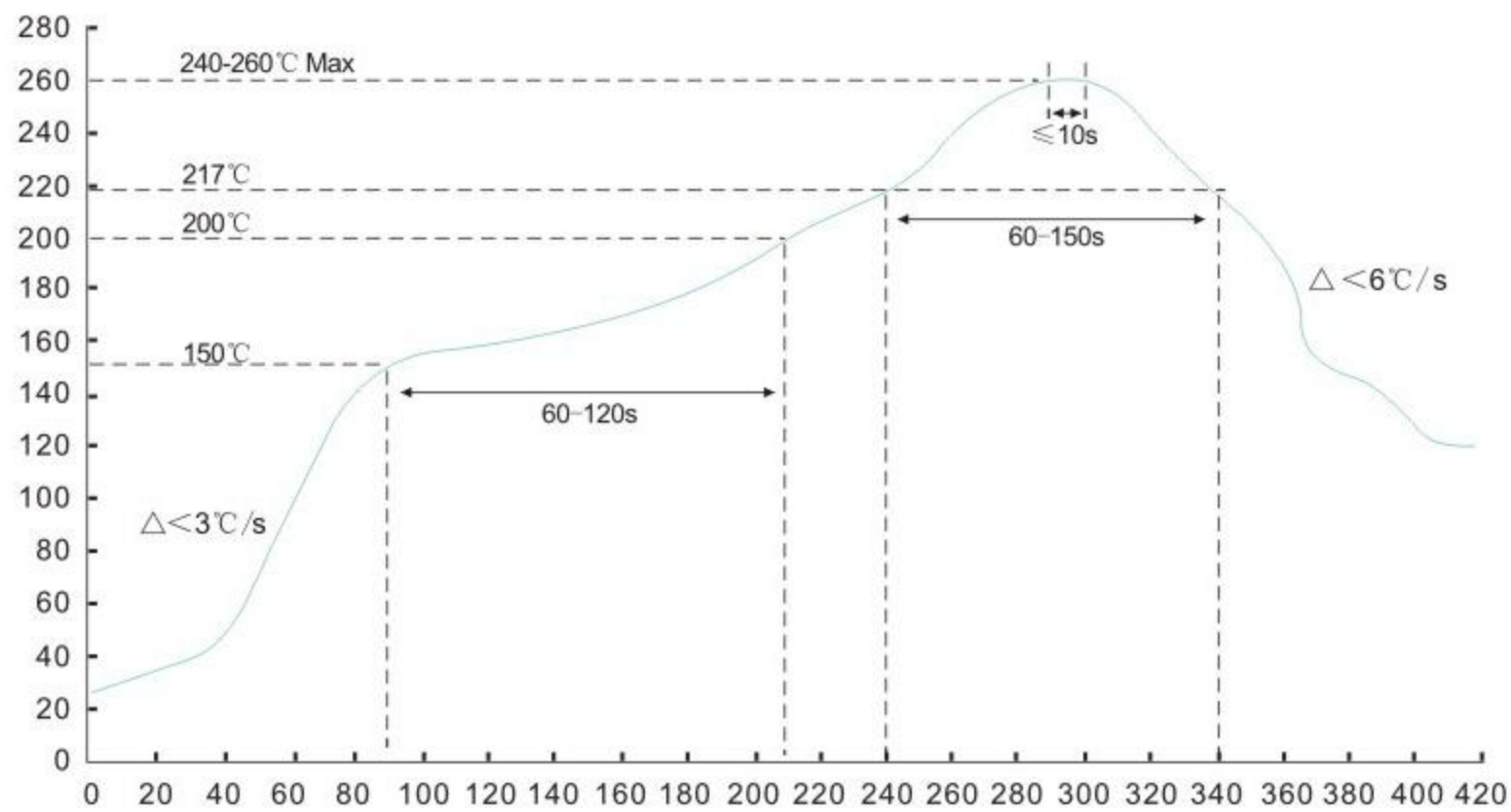

### ■ 建议波峰焊曲线 ( Recommend wave soldering profile )

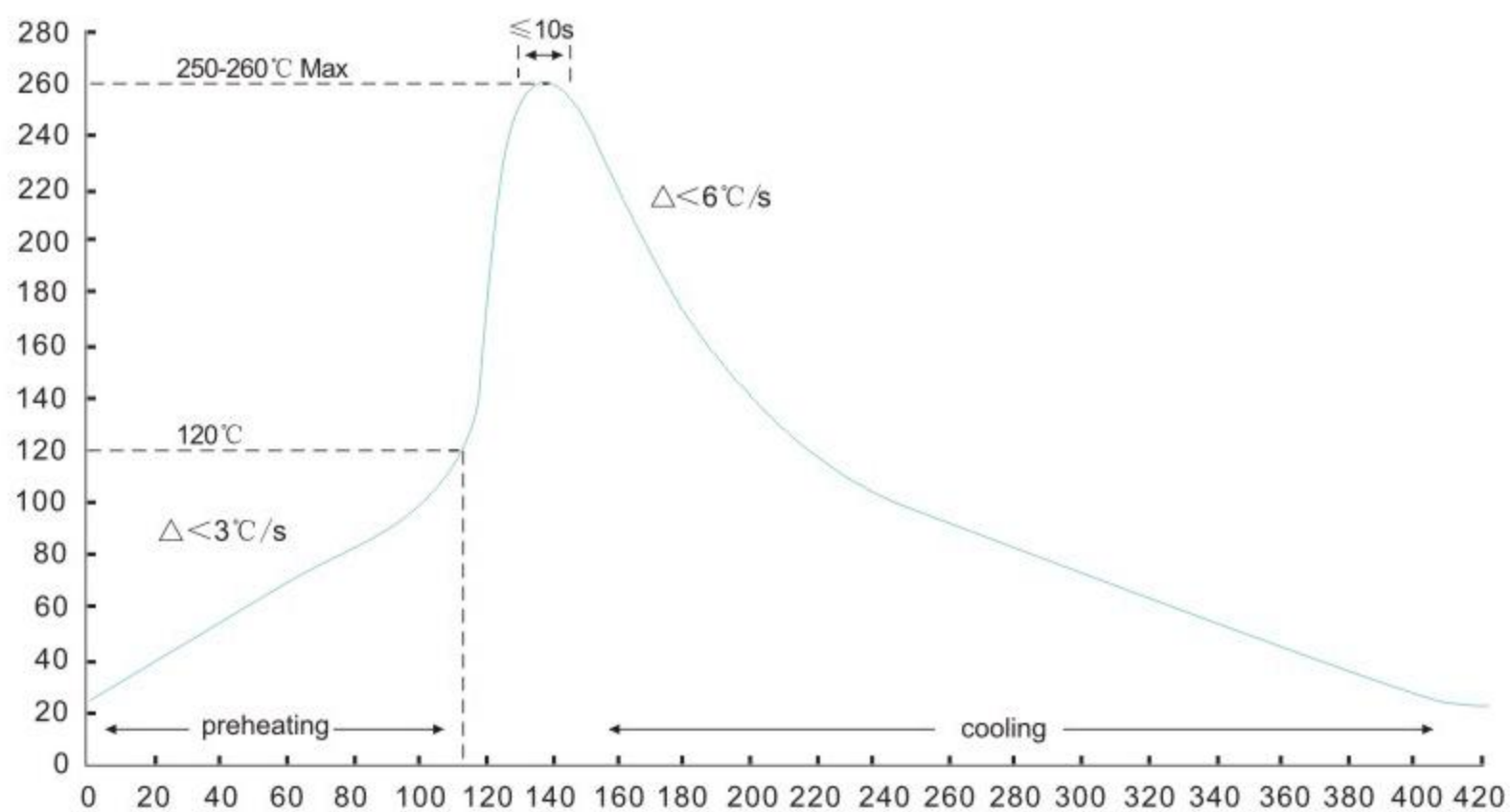

### ■ 手工焊温度 ( hand soldering temperature )

烙铁温度  $350 \pm 10^\circ\text{C}$  3 秒之内，避免烙铁接触电阻本体

The iron temperature is  $350 \pm 10^\circ\text{C}$ , hand soldering time less than 3S. Avoid solder iron tip direct touch the components body

## X-ON Electronics

Largest Supplier of Electrical and Electronic Components

*Click to view similar products for* [Thick Film Resistors - SMD category:](#)

*Click to view products by* [FOJAN Electronics manufacturer:](#)

Other Similar products are found below :

[CR-05FL7--150R](#) [CR-05FL7--19K6](#) [CR-05FL7--243R](#) [CR-05FL7--40K2](#) [CR-05FL7--698K](#) [CR-12FP4--324R](#) [CR-12JP4--680R](#)

[M55342K06B1E78RS3](#) [M55342K06B6E19RWL](#) [M55342K06B6E81RS3](#) [M55342M05B200DRWB](#) [M55342M06B4K70MS3](#) [MC0603-511-](#)

[JTW](#) [742C083750JTR](#) [MCR01MZPF1202](#) [MCR01MZPF1601](#) [MCR01MZPF1800](#) [MCR01MZPF6201](#) [MCR01MZPF9102](#) [MCR01MZPJ113](#)

[MCR01MZPJ121](#) [MCR01MZPJ125](#) [MCR01MZPJ751](#) [MCR03EZHJ103](#) [MCR03EZPFX2004](#) [MCR03EZPJ270](#) [MCR03EZPJ821](#)

[MCR10EZPF1102](#) [MCR18EZPJ330](#) [RC0603F1473CS](#) [RC0603F150CS](#) [RC1005F1152CS](#) [RC1005F1182CS](#) [RC1005F1372CS](#)

[RC1005F183CS](#) [RC1005F1911CS](#) [RC1005F1912CS](#) [RC1005F203CS](#) [RC1005F2052CS](#) [RC1005F241CS](#) [RC1005F2431CS](#)

[RC1005F3011CS](#) [RC1005F303CS](#) [RC1005F4321CS](#) [RC1005F4642CS](#) [RC1005F471CS](#) [RC1005F4751CS](#) [RC1005F5621CS](#)

[RC1005F6041CS](#) [RC1005J106CS](#)