

高精度厚膜晶片电阻 High Precision Thick Film Chip Resistor FRH Series



■应用 (Application)

- Medical, Precision equipments, Electricmeter
- Converters, Communication devices, Battery
- Measuring instrument , Printers, SmartPhone

- 医疗,精密设备,电表
- 转换器,通信设备,电池
- 测量仪器,印表机,智能手机

■特性 (Features)

- Tight tolerance from $\pm 0.1\%$, $\pm 0.25\%$, $\pm 0.5\%$,

- 精密公差 $\pm 0.1\%$, $\pm 0.25\%$, $\pm 0.5\%$,

■料号说明 (Parts Number Explanation)

示例 Example: FRH1206D1001 TS

<u>F</u> 公司名	<u>R</u> 产品别	<u>H</u> 功能别	<u>1206</u> 型别	<u>D</u> 公差	<u>1001</u> 字码	<u>I</u> 包装别	<u>S</u> 端电极	特殊型
FOJAN	R:Resistor	H:Hi-Precision	0402 0603 0805 1206 1210 2010 2512	B: $\pm 0.1\%$ C: $\pm 0.25\%$ D: $\pm 0.5\%$ F: $\pm 1\%$ J: $\pm 5\%$ P : Jumper	$\pm 5\%$:E24 3-digits+blank 102=1K Ω 1R0=1 Ω $\pm 1\%$ &Below : E24+E96 : 4-digits 1001=1K Ω 1R00=1 Ω	T: 7 inch reel Q:10 inch reel R:13 inch reel B:Bulk	S : Sn C : Cu A : Au	N:Normal
Company code	Type code	Functional code	Size code	Tolerance code	Resistance code	Packaging code	Termination code	Special code

■尺寸 (Dimension)

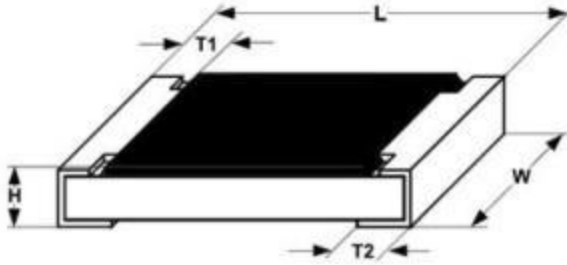
尺寸 dimension					
	单位 (unit) : mm				
型别 (Type)	L	W	H	T1	T2
0402	1.00±0.05	0.50±0.05	0.35±0.05	0.20±0.10	0.25±0.10
0603	1.60±0.10	0.80±0.10	0.45±0.10	0.25±0.15	0.25±0.15
0805	2.00±0.10	1.25±0.10	0.50±0.10	0.35±0.20	0.35±0.20
1206	3.10±0.10	1.60±0.10	0.55±0.10	0.45±0.20	0.40±0.20
1210	3.10±0.10	2.60±0.15	0.55±0.10	0.45±0.15	0.50±0.20
2010	5.00±0.10	2.50±0.15	0.55±0.10	0.45±0.15	0.50±0.20
2512	6.35±0.10	3.10±0.15	0.55±0.10	0.60±0.20	0.50±0.20

■电阻结构 (Construction)

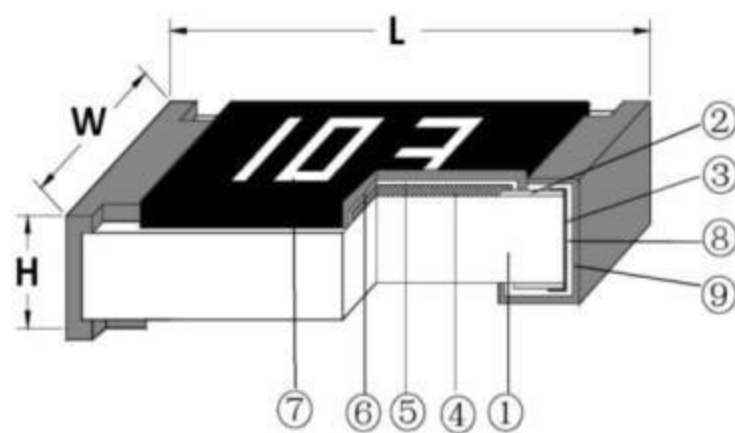

NO.	结构 construction	主要材料 Major material
1	陶瓷基板 Ceramic substrate	三氧化二铝 Al ₂ O ₃
2	银电极 Conductive layer	银 Ag
3	侧电极 Side conductive layer	镍铬合金 NiCr
4	阻体层 Resistive layer	氧化钌+玻璃 RuO ₂ + glass
5	内保护层 Inner protective layer	玻璃 Glass
6	外保护层 Outer Protective layer	环氧树脂 Epoxy
7	文字 Marking	环氧树脂 Epoxy
8	镍电极 Ni plating layer	镍 Ni
9	锡电极 Sn plating layer	锡 Matte Tin

■功率衰减曲线 (Derating Curve)

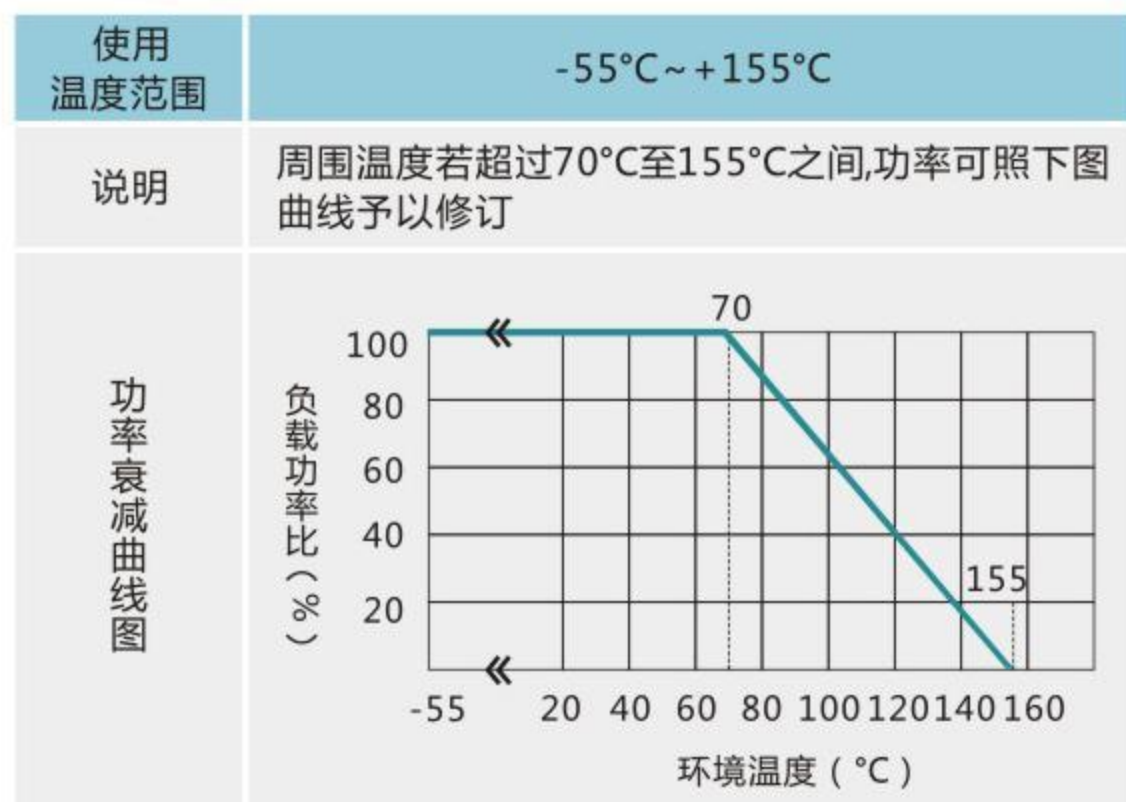

■阻值范围 (Resistance range)

型别 Type	阻值范围 Resistance Range	
	0.5%	0.1%
0402	10Ω~1MΩ	10Ω~1MΩ
0603	10Ω~1MΩ	10Ω~1MΩ
0805	10Ω~1MΩ	10Ω~1MΩ
1206	10Ω~1MΩ	10Ω~1MΩ
1210	10Ω~1MΩ	10Ω~1MΩ
2010	10Ω~1MΩ	10Ω~1MΩ
2512	10Ω~1MΩ	10Ω~1MΩ

如有非标准品的需求,请联系我们的业务部门 For non-standard parts, please contact our sales dept.

■电气特性 (Electrical characteristics)

型别 Type	0402	0603	0805	1206	1210	2010	2512
额定功率 Rated power	1/16W	1/10W	1/8W	1/4W	1/2W	3/4W	1W
最大工作电压 Max Working Voltage	50V	75V	150V	200V	200V	200V	200V
最大过负荷电压 Max Overload Voltage	100V	150V	300V	400V	400V	400V	400V
绝缘耐压 Dielectric Withstanding Voltage	100V	100V	300V	500V	500V	500V	500V

型别 Type	0402	0603	0805	1206	1210	2010	2512
零欧姆阻值 ±1% Resistance Value of Jumper ±1%	<30mΩ	<30mΩ	<30mΩ	<30mΩ	<30mΩ	<30mΩ	<30mΩ
零欧姆阻值 ±5% Resistance Value of Jumper ±5%	<50mΩ	<50mΩ	<50mΩ	<50mΩ	<50mΩ	<50mΩ	<50mΩ
零欧姆额定电流 Rated Current of Jumper	1A	1A	2A	2A	2A	2A	2A
零欧姆电阻最大电流 Max Current of Jumper	2A	2A	5A	10A	10A	10A	10A





性能 (Performance Specifications)

内容 Item	测试方法 Test Methods	测试条件 Test Conditions	规格 Specification
温度系数 Temperature Coefficient	JIS C 5201 4.8	$TCR = (R - R_0) / (t - t_0) R_0 \times 10^6$ (ppm) R_0 电阻在室温下的阻值(resistance at room temperature) R 电阻在 125℃或-55℃下的阻值(resistance at 125℃ or -55℃) t_0 室温(room temperature) t 测试温度 (test temperature 125℃ or -55℃)	$1\Omega \leq R \leq 10\Omega$: ±200 PPM/℃ $10\Omega < R \leq 10M\Omega$: ±100 PPM/℃
短时间过负荷 Short-time overload	JIS C 5201 4.13	加载 2.5 倍的额定电压，时间 5 秒后测量试验前后的阻值变化率。 Applied 2.5 times of rated voltage for 5 second. Measure the variation of resistance.	±(1.00% +0.05Ω)
焊锡性 Solderability	JIS C 5201 4.17	沾助焊剂后浸入锡炉，锡炉温度 245±5℃，时间 3±0.5 秒。 Dip the terminal in a flux and then dip into a soldering bath at 245±5℃ for 3±0.5sec.	> 95%面积上锡 (> 95% coverage)
抗焊锡热 Resist to soldering heat	JIS C 5201 4.18	沾助焊剂后浸入锡炉，锡炉温度 260±5℃，时间 10±0.5 秒，测量试验前后的阻值变化率。 Dip the terminal in a flux and then dip into a soldering bath at 260±5℃ for 10±0.5sec. Measure the variation of resistance.	±(1.00% +0.05Ω)

内容 Item	测试方法 Test Methods	测试条件 Test Conditions	规格 Specification
绝缘电阻 Insulation resistance	JIS C 5201 4.6	电阻本体上加载绝缘耐压 60±5 秒后, 测量绝缘阻抗。 Applied the dielectric withstanding voltage on the center of body for 60±5seconds. Then measure insulation resistance.	>10GΩ
绝缘耐压 Dielectric withstanding voltage	JIS C 5201 4.7	电阻本体上加载绝缘耐压 60±5 秒。 Applied the dielectric withstanding voltage on the center of body for 60±5seconds.	无击穿、飞弧及可见机械性损伤 No evidence of flashover, mechanical damage arcing or insulation breakdown
端子弯曲 Terminal bending	JIS C 5201 4.33	电阻焊接在测试板上进行弯折, 弯折保持时间 20±1 秒, 1206(含) 以下的尺寸弯曲 5+0.2/0 mm; 1206 以上的尺寸弯曲 2+0.2/0 mm; 量测试前后阻值变化率 Specimen shall be mounted on test board, then bend the board and maintained for 20±1s. the distance of bending is 5+0.2/0 mm for resistors which size no larger than 1206 or 2+0.2/0 mm which size larger than 1206. Measure the variation of resistance.	±(1.00% +0.05Ω)
温度循环 Temperature Cycling	JIS C 5201 4.19	电阻放入温度循环机中, 温度 155±2℃至 -55±3℃, 共 5 个循环。量测试前后阻值变化率。 Put specimen in a chamber which temperature can be changed to 155±2℃ or -55±3℃, repeated 5 times. Measure the variation of resistance.	±(2.00% +0.05Ω)

内容 Item	测试方法 Test Methods	测试条件 Test Conditions	规格 Specification
耐湿特性 Humidity	JIS C 5201 4.24	<p>电阻放入恒温恒湿箱，温度 $40\pm 2^{\circ}\text{C}$，湿度 90~95 %RH;通电额定电压 1.5 小时，断电 0.5 小时；重复通断电至试验时间 $1000^{+48}/_{-0}$ 小时。量测试验前后阻值变化率。</p> <p>Put the specimen in a chamber at $40\pm 2^{\circ}\text{C}$ temperature and 90~95% relative humidity, then applied rated voltage for 1.5H and rested for 0.5H repeatedly till total test time is $1000^{+48}/_{-0}$ H. Measure the variation of resistance.</p>	$\pm(2.00\% +0.05\Omega)$
负荷寿命 Load life	JIS C 5201 4.25.1	<p>电阻放入恒温箱中，温度 $70\pm 2^{\circ}\text{C}$，ON TIME:1.5H，OFF TIME:0.5H，通电额定电压 $1000^{+24}/_{-0}$ 小时，量测试验前后阻值变化率。</p> <p>Put the specimen in a chamber at $70\pm 2^{\circ}\text{C}$ temperature, ON TIME:1.5H，OFF TIME:0.5H，and applied rated voltage for $1000^{+24}/_{-0}$H. Measure the variation of resistance.</p>	$\pm(2.00\% +0.05\Omega)$
温湿循环 Moisture resistance	MIL-STD-202 METHOD 106	<p>$25^{\circ}\text{C}\sim 65^{\circ}\text{C}$, 90~100%RH, 2.5 小时; 65°C 90~100%RH, 3 小时; $65^{\circ}\text{C}\sim 25^{\circ}\text{C}$, 80~100%RH, 2.5 小时, 10 个循环, 试验结束 24 ± 4 小时后进行测试。</p> <p>$25^{\circ}\text{C}\sim 65^{\circ}\text{C}$, 90~100%RH, 2.5H; 65°C 90~100%RH, 3H; $65^{\circ}\text{C}\sim 25^{\circ}\text{C}$ 80~100%RH, 2.5H, 10 cycles, Measurement at 24 ± 4 hours after test conclusion.</p>	$\pm(2.00\% +0.05\Omega)$

电阻本体字码标识 Marking on the Resistor's Body

<p>0201 及 0402 因本体太小，本体上无字码标示 For 0201 and 0402 size, no marking on the body due to the small size of the resistor</p> <p>公差±5%的产品，以三字码标示，前两位表示阻值的有效数字，最后一位表示 10 的乘幂 ±5% tolerance product: the marking is 3 digits, the first 2 digits are significant figures of resistance value and the 3rd one denotes the power number of 10, (10X)</p> <p>±0.5%, ±1%, ±2%的产品，以四字码标示，前三位表示阻值的有效数字，最后一位表示 10 的乘幂 ±0.5%, ±1%, ±2% tolerance product: the marking is 4 digits, the first 3 digits are significant figures of resistance value and the 4th one denotes the power number of 10, (10X)</p> <p>0603 ±1% E96 系列的标准阻值，因电阻本体太小，采用三位代码标示。 Standard E96 series values of 0603 ±1%: due to the small size of the resistor's body, use 3digits code to indicate the resistance value.</p>	   	<p>472=47×10²=4.7KΩ</p> <hr/> <p>10Ω以下标示：5R6=5.6Ω Below 10Ω: 5R6=5.6Ω</p> <hr/> <p>4992=499×10²=49.9KΩ</p> <hr/> <p>100Ω以下标示：6R81=6.81Ω Below 100Ω: 6R81=6.81Ω</p>
---	--	--

用于 0603±1%标记的标准 E96 系列电阻值代码 Standard E96 Series Resistance Value Code for 0603 ±1% Marking

代码 Code	阻值 Value	代码 Code	阻值 Value	代码 Code	阻值 Value	代码 Code	阻值 Value	代码 Code	阻值 Value	代码 Code	阻值 Value
01	100	17	147	33	215	49	316	65	464	81	681
02	102	18	150	34	221	50	324	66	475	82	698
03	105	19	154	35	226	51	332	67	487	83	715
04	107	20	158	36	223	52	340	68	499	84	732
05	110	21	162	37	237	53	348	69	511	85	750
06	113	22	165	38	243	54	357	70	523	86	768
07	115	23	169	39	249	55	365	71	536	87	787
08	118	24	174	40	255	56	374	72	549	88	806
09	121	25	178	41	261	57	383	73	562	89	825
10	124	26	182	42	267	58	392	74	576	90	845
11	127	27	187	43	274	59	402	75	590	91	866
12	130	28	191	44	280	60	412	76	604	92	887
13	133	29	196	45	287	61	422	77	619	93	909
14	137	30	200	46	294	62	432	78	634	94	931
15	140	31	205	47	301	63	442	79	649	95	953
16	143	32	210	48	309	64	453	80	665	96	976

■0603±1%标记的倍增码：Multiplier Code for 0603 ±1% Marking:

代码 Code	Y	X	A	B	C	D	E	F
指数 Multiplier	10 ⁻²	10 ⁻¹	10 ⁰	10 ¹	10 ²	10 ³	10 ⁴	10 ⁵

阻值标示如下(So the resistance value are marked as the following examples)



$$10D=124 \times 10^3=124K\Omega$$



$$38Y=243 \times 10^{-2}=2.43\Omega$$

0603 ±1%的产品，在标准 E24 系列中，但不属于 E96 系列，标示与 5%的字码相同，但是在中间字码下加一条线 (Standard E24 and not belong to E96 series values of 0603 ±1%, the marking is the same as 5% tolerance but marking as underline)



$$33\underline{1}=33 \times 10^1=330\Omega$$



$$56\underline{0}=56 \times 10^0=56\Omega$$

■FRL 系列低阻本体标识 (Marking on the Low Resistor's Body)

<p>0402 因本体太小，本体上无字码标示。 For 0402 size, no marking on the body due to the small size of the resistor</p>		
<p>0603 尺寸的产品，以三字码标示，第一位码R 表示10⁻³，后两位表示阻值的有效数字；第一位码0表示小于100毫欧产品，后两位表示阻值的有效数字。 For 0603 size, use three digitals to declare resistance. The first letter 'R'denotes 10⁻³, The other two digitals declare resistance ; The first letter '0'means less than 100 mohm products, The other two digitals declare resistance.</p>		<p>R10=0R10=0.1Ω R47=0R47=0.47Ω</p>
<p>0603 以上尺寸的产品，以四字码标示，第一位码R表示10⁻³，后三位表示阻值的有效数字。 The size larger than 0603, use four digitals to declare resistance. The first letter 'R'denotes 10⁻³, The other three digitals declare resistance.</p>	 	<p>R010=R010=0.010Ω R220=0R22=0.22Ω R330=0R33=0.33Ω</p>

▪标准阻段 (Standard Nominal Resistance Values)

IEC-63 Nominal Resistance/Capacitance

E1	E3	E6	E12	E24	E96			
100	100	100	100	100	100	105	110	115
				110	102	107	113	118
		120	120	121	127	133	140	
			130	124	130	137	143	
		150	150	150	147	154	162	169
				160	150	158	165	174
	180		180	178	187	196	205	
			200	182	191	200	210	
	220	220	220	220	215	226	237	249
				240	221	232	243	255
		270	270	261	274	287	301	
			300	267	280	294	309	
		330	330	330	316	332	348	365
				360	324	340	357	374
	470	390	390	390	383	402	422	442
				430	392	412	432	453
		470	470	470	464	487	511	536
				510	475	499	523	549
		560	560	560	562	590	619	649
				620	576	604	634	665
	680	680	680	680	681	715	750	787
				750	698	732	768	806
		820	820	820	825	866	909	953
				910	845	887	931	976

$$E6 : \sqrt[6]{10}=1.46 \quad E12 \sqrt[12]{10}=1.21$$

E1 series resistance:1Ω.10Ω.100Ω.1000Ω.10000Ω.100000Ω

包装规格 Tapping Specification

Reel

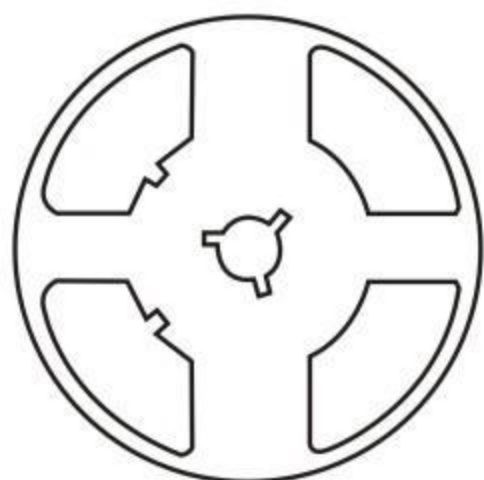

Standard Quantity per Reel
5,000 pcs/Reel

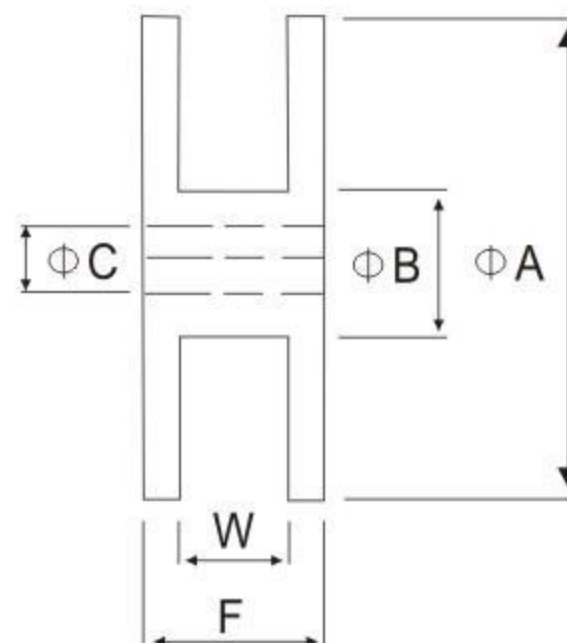

Unit: mm

■卷盘尺寸 (Reel dimension)

Type	Size		Unit	A	B	C	F	W
0201/0402	7"	10K/Reel 15K/Reel 0201 only	mm	178±2.0	60.0±1.0	13.5±0.5	11.4±0.1	9.00±0.3
0402	13"	40K/50K Reel	mm	178±2.0	60.0±1.0	13.5±0.5	11.4±0.1	9.00±0.3
0603/0805/1206/1210 044R/064R	7"	5K/Reel	mm	178±2.0	60.0±1.0	13.5±0.5	11.4±0.1	9.00±0.3
0603/0805/1206	10"	10K/Reel	mm	178±2.0	60.0±1.0	13.5±0.5	11.4±0.1	9.00±0.3
0603/0805/1206	13"	20K/Reel	mm	178±2.0	60.0±1.0	13.5±0.5	11.4±0.1	9.00±0.3
1218/1812/2010/2512	7"	4K/Reel	mm	178±2.0	60.0±1.0	13.5±0.5	15.4±1.0	13.0±0.3

备注 (Remark) :

- (1) 0201/0402 每卷 10,000pcs
0201/0402 Quantity per Reel 10,000pcs/Reel
- (2) 0603/0805/1206/1210/044R/064R 每卷 5,000pcs
0603/0805/1206/1210/044R/064R Quantity per Reel 5,000pcs/Reel
- (3) 1812/2010/2512/1218 每卷 4,000pcs
1812/2010/2512/1218 Quantity per Reel 4,000pcs/Reel

■包装尺寸 (packing dimension)

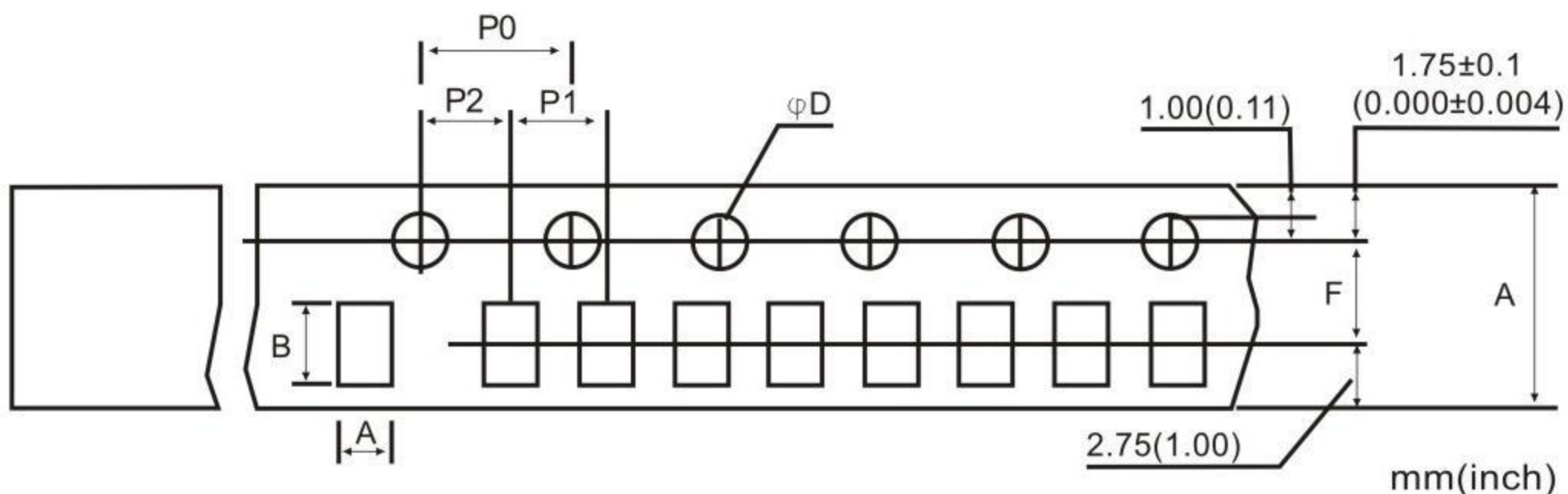

Dimensions	A	B	D	F	P0	P1	P2	W
0201	0.38±0.05	0.68±0.05	1.50± ^{0.1} / _{0.0}	3.50±0.05	4.00±0.10	2.00±0.10	2.00±0.05	8.00±0.20
0402	0.65±0.10	1.15±0.10	1.50± ^{0.1} / _{0.0}	3.50±0.05	4.00±0.10	2.00±0.10	2.00±0.05	8.00±0.20
0603	1.10±0.10	1.90±0.10	1.50± ^{0.1} / _{0.0}	3.50±0.05	4.00±0.10	4.00±0.10	2.00±0.05	8.00±0.20
0805	1.65±0.20	2.40±0.20	1.50± ^{0.1} / _{0.0}	3.50±0.05	4.00±0.10	4.00±0.10	2.00±0.05	8.00±0.20
044R	1.20±0.20	2.20±0.20	1.50± ^{0.1} / _{0.0}	3.50±0.05	4.00±0.10	4.00±0.10	2.00±0.05	8.00±0.20
1206/064R	1.90±0.20	3.50±0.20	1.50± ^{0.1} / _{0.0}	3.50±0.05	4.00±0.10	4.00±0.10	2.00±0.05	8.00±0.20
1210	2.80±0.20	3.50±0.20	1.50± ^{0.1} / _{0.0}	3.50±0.05	4.00±0.10	4.00±0.10	2.00±0.05	8.00±0.20
1218	2.80±0.20	4.60±0.20	1.50± ^{0.1} / _{0.0}	5.50±0.05	4.00±0.10	4.00±0.10	2.00±0.05	12.0±0.10
1812	3.30±0.20	4.60±0.20	1.50± ^{0.1} / _{0.0}	5.50±0.05	4.00±0.10	4.00±0.10	2.00±0.05	12.0±0.10
2010	2.90±0.10	5.30±0.10	1.50± ^{0.1} / _{0.0}	5.50±0.05	4.00±0.10	4.00±0.10	2.00±0.05	12.0±0.10
2512	3.40±0.10	6.60±0.10	1.50± ^{0.1} / _{0.0}	5.50±0.05	4.00±0.10	4.00±0.10	2.00±0.05	12.0±0.10

包装材料资料/储存资料
Packing Material Data/Storage Data

▪前/后导带尺寸 (Front & Back Lead Dimension)

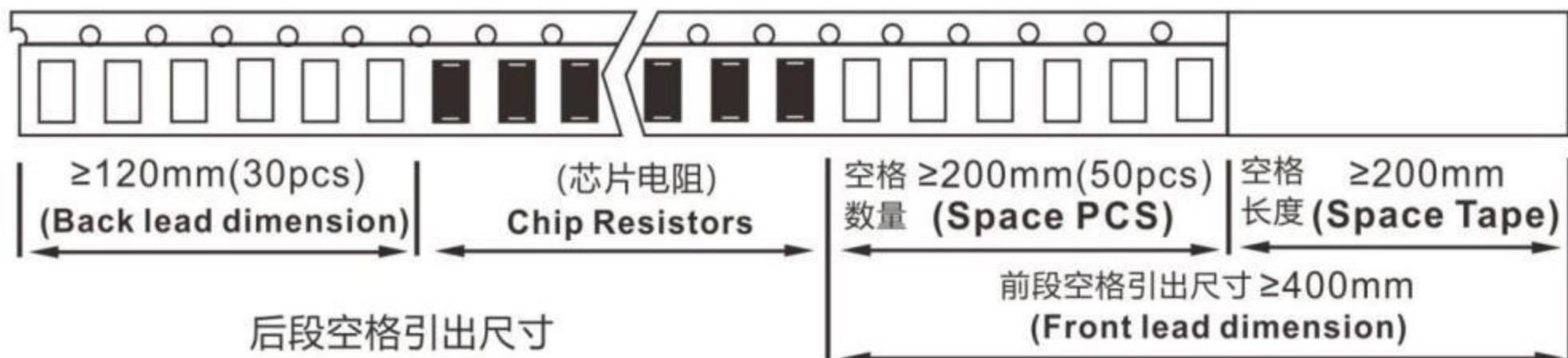

▪上胶带剥离力测试 (Peel force of top cover tape)

上胶带以 200mm/分钟的速度，沿 165~180 度角的方向进行剥离，如下图所示。纸带的剥离力范围为 10g~70g；载带的剥离力范围为 30~100g。

The top cover tape is pulled at a speed of 200 mm/min with the angle between the tape during peel and the direction of unreeling maintained at 165 to 180 degree as following picture. The peel force of paper carrier tape shall be 0.1N to 0.7N(10 to 70 g), the peel force of plastic carrier tape shall be 0.3N to 1N (30 to 100 g)

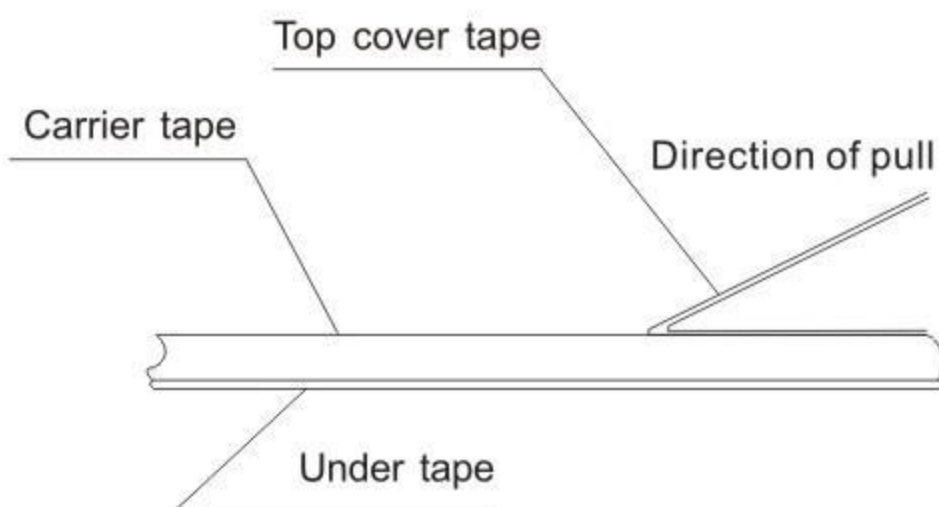

▪储存资料 (Storage Data)

Storage time at the environment temp: $25\pm 5^{\circ}\text{C}$ & humidity: $60\pm 20\%$ is valid for two year from the date of delivery.

储存效期：在环境温度： $25\pm 5^{\circ}\text{C}$ ，湿度： $60\pm 20\%$ ，自交付日起二年

焊接 soldering

■ 建议回流焊曲线 (Recommend reflow soldering profile)

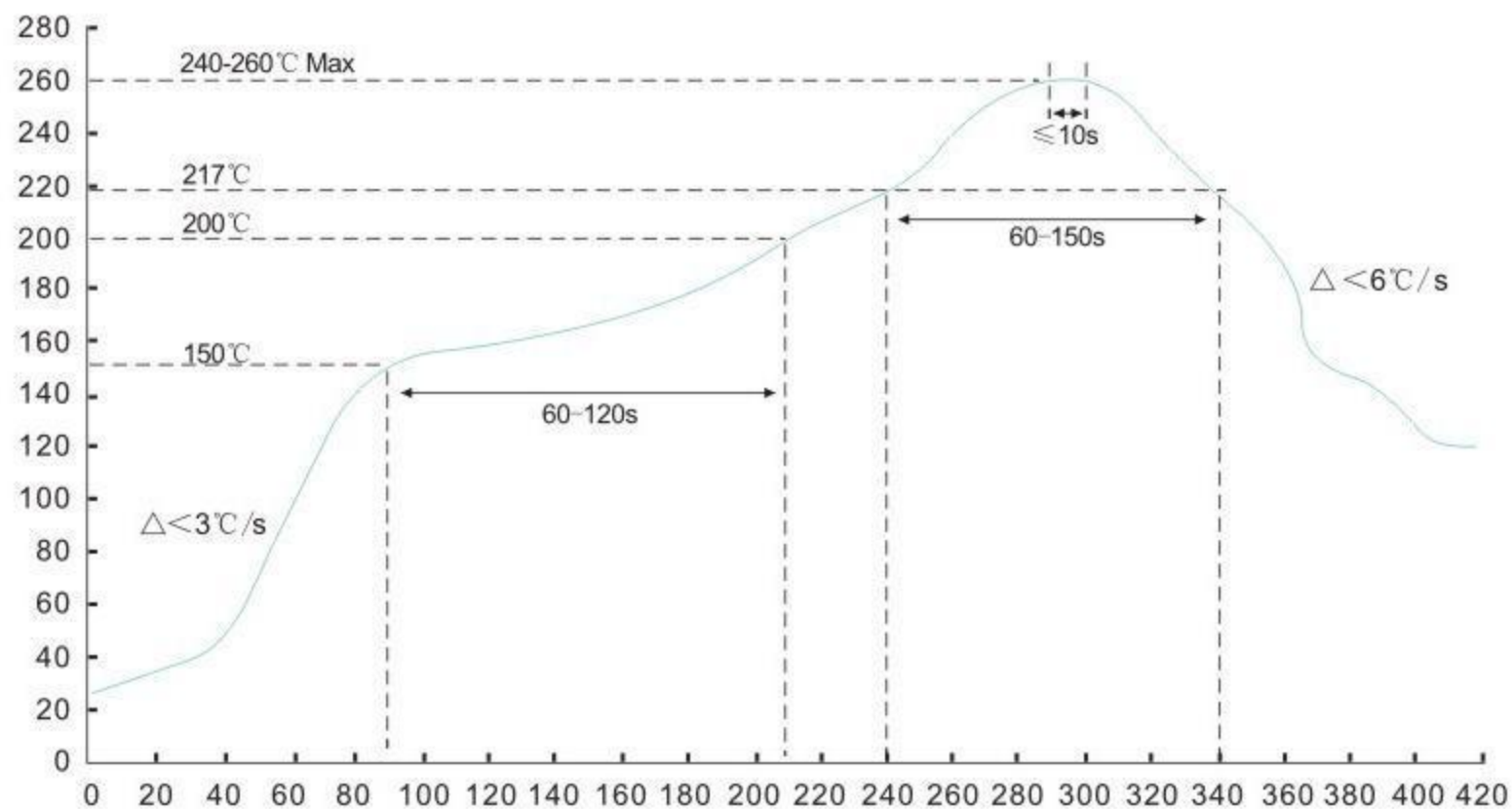

■ 建议波峰焊曲线 (Recommend wave soldering profile)

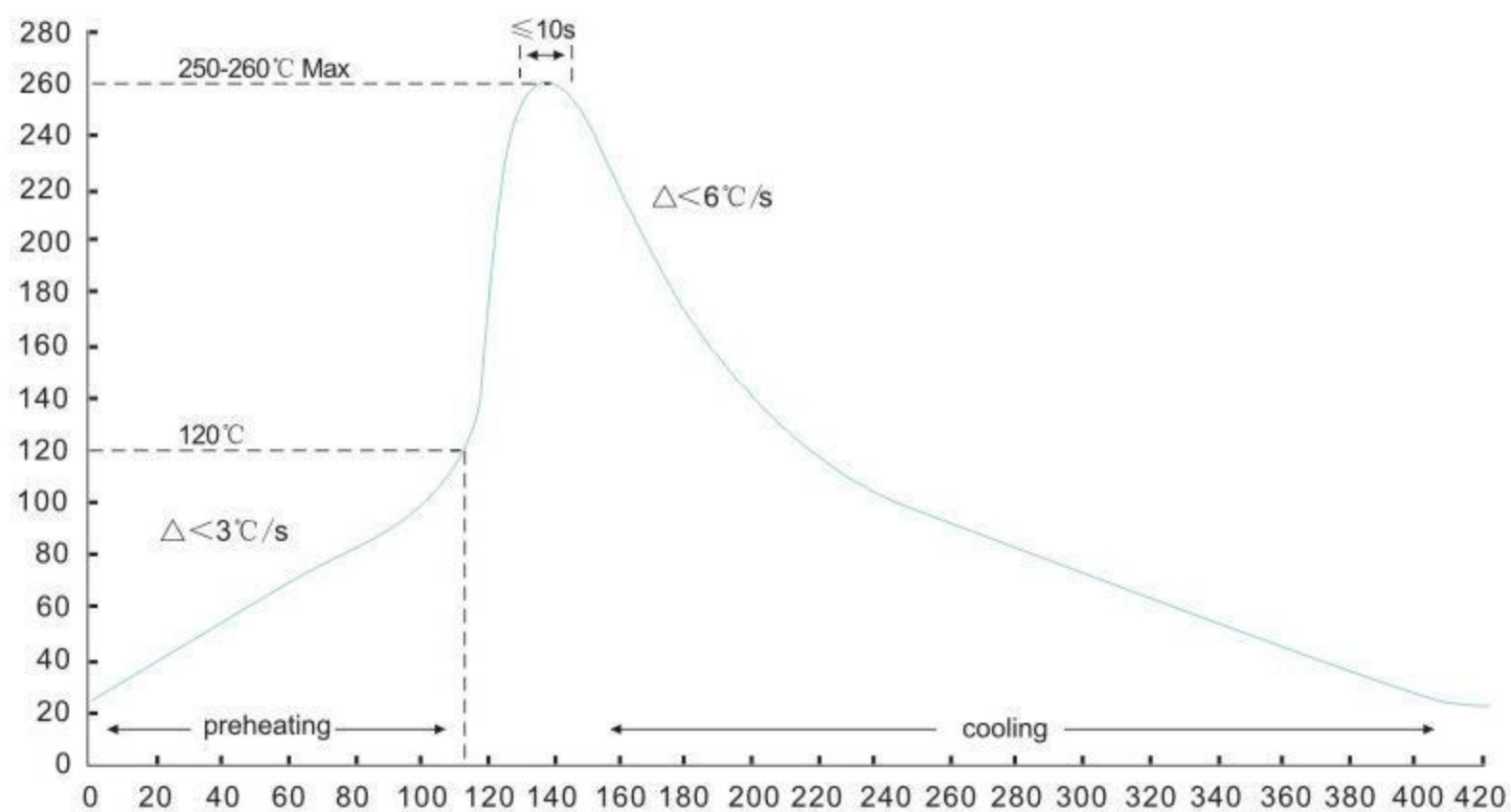

■ 手工焊温度 (hand soldering temperature)

烙铁温度 $350 \pm 10^\circ\text{C}$ 3 秒之内，避免烙铁接触电阻本体

The iron temperature is $350 \pm 10^\circ\text{C}$, hand soldering time less than 3S. Avoid solder iron tip direct touch the components body

X-ON Electronics

Largest Supplier of Electrical and Electronic Components

Click to view similar products for [Thick Film Resistors - SMD category:](#)

Click to view products by [FOJAN Electronics manufacturer:](#)

Other Similar products are found below :

[CR-05FL7--150R](#) [CR-05FL7--698K](#) [CR-12JP4--680R](#) [CRCW04021K20FKEE](#) [CRCW04028R20JNEE](#) [CRCW06032K10FKEC](#)

[CRCW06036K80FKEE](#) [M55342K03B499DRS6](#) [M55342K06B14E0RS6](#) [M55342K06B1E78RS3](#) [M55342K06B6E19RWL](#)

[M55342K06B6E81RS3](#) [M55342K09B5D62RS6](#) [M55342M05B200DRWB](#) [M55342M06B26E7RS3](#) [M55342M06B4K70MS3](#)

[742C083750JTR](#) [MCR01MZPF1202](#) [MCR01MZPF1601](#) [MCR01MZPF1800](#) [MCR01MZPF6201](#) [MCR01MZPF9102](#) [MCR01MZPJ121](#)

[MCR01MZPJ125](#) [MCR01MZPJ751](#) [MCR03EZHJ103](#) [MCR03EZPFX2004](#) [MCR03EZPJ270](#) [MCR03EZPJ821](#) [MCR10EZPF1102](#)

[MCR10EZPF2700](#) [MCR18EZPJ330](#) [RC1005F1152CS](#) [RC1005F1372CS](#) [RC1005F1912CS](#) [RC1005F2052CS](#) [RC1005F3011CS](#)

[RC1005F471CS](#) [RC1005F4751CS](#) [RC1005F5621CS](#) [RC1005F6041CS](#) [RC1005J121CS](#) [RC1005J122CS](#) [RC1005J154CS](#) [RC1005J180CS](#)

[RC1005J181CS](#) [RC1005J202CS](#) [RC1005J391CS](#) [RC1005J560CS](#) [RC1608F1022CS](#)