

1.5KE SERIES

List

List..... 1

Package outline..... 2

Features..... 2

Mechanical data..... 2

Maximum ratings2

Electrical characteristics..... 3

Rating and characteristic curves..... 4

Pinning information.....5

Taping & bulk specifications for AXIAL devices..... 5

Suggested thermal profiles for soldering processes..... 6

High reliability test capabilities.....7



1.5KE SERIES

1500W Axial Lead Transient Voltage Suppressors - 6.8V-440V

Features

- Glass passivated chipn.
- 1500 W peak pulse power capability with a 10/1000us waveform, repetitive rate (duty cycle):0.01 %
- Low leakage.
- Excellent clamping capability.
- Very fast response time.
- Lead-free parts meet RoHS requirements.
- Suffix "-H" indicates Halogen free parts, ex. 1.5KE6.8A-H

Mechanical data

- Epoxy : UL94-V0 rated flame retardant
- Case : Molded plastic, DO-201AE
- Lead : Axial leads, solderable per MIL-STD-202, Method 208 guranteed
- Polarity: Color band denotes cathode end
- Mounting Position : Any
- Weight : Approximated 1.20 gram

Package outline

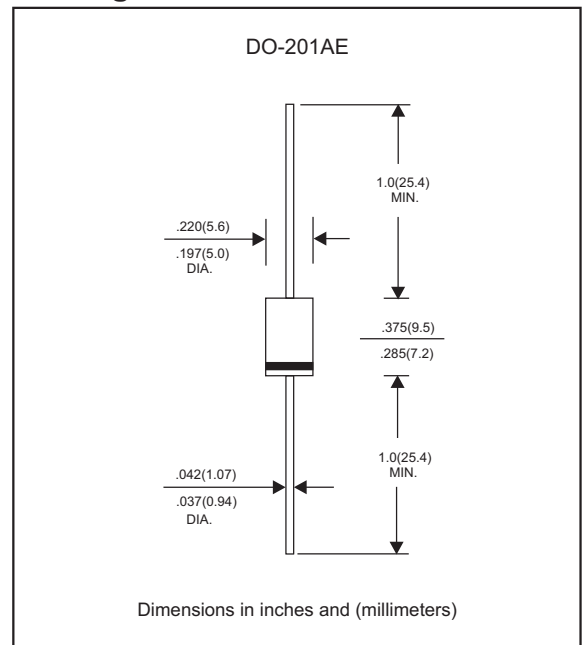

Maximum ratings (AT $T_A=25^\circ\text{C}$ unless otherwise noted)

PARAMETER	CONDITIONS	Symbol	1.5KE series	UNIT
Peak power dissipation	with a 10/1000us waveform, note 1 & fig.1	P_{PPM}	1500	W
Peak pulse current	with a 10/1000us waveform, note 1 & fig.1	I_{PPM}	See Table 1	A
Steady state power dissipation	at $T_L=75^\circ\text{C}$, lead length 0.375"(9.5mm)	$P_{M(AV)}$	6.5	W
Peak forward surge current	8.3ms single half sine-wave (JEDEC Mthod), note 2	I_{FSM}	200	A
Maximum instantaneours forward voltage	at 100A for Uni-Directional types only, note 3	V_F	3.5/5.0	V
Operating junction temperature range		T_J	-55 to +150	$^\circ\text{C}$
Storage temperature range		T_{STG}	-55 to +150	$^\circ\text{C}$

Note 1. Non-repetitive current pulse, per Fig. 3 and derated above $T_A=25^\circ\text{C}$ per Fig. 2

2. Measured on 8.3 mS single half sine-wave or equivalent square wave, duty cycle=4 pulses per minute maximum

3. $V_F < 3.5\text{V}$. for devices of $V_{BR} < 200\text{V}$, and $V_F < 5.0\text{V}$. for devices of $V_{BR} > 201\text{V}$

Electrical characteristics (at $T_A=25^{\circ}\text{C}$ unless otherwise noted) Table 1

Part No. (Uni)	Part No. (Bi)	Reverse Stand-off Voltage	Breakdown Voltage @ I_T		Test Current	Maximum Clamping Voltage @ I_{PP}		Maximum Reverse Leakage Current	Marking Code	
		V_{RWM}	$V_{BR\ Min}$	$V_{BR\ Max}$	I_T	V_c	I_{PP}	$I_R@V_{RWM}$	(Uni)	(Bi)
		Volts	Volts	Volts	mA	Volts	A	μA		
1.5KE6.8A	1.5KE6.8CA	5.80	6.45	7.14	10	10.5	142.8	1000	1.5KE6.8A	1.5KE6.8CA
1.5KE7.5A	1.5KE7.5CA	6.40	7.13	7.88	10	11.3	132.7	500	1.5KE7.5A	1.5KE7.5CA
1.5KE8.2A	1.5KE8.2CA	7.02	7.79	8.61	10	12.1	123.9	200	1.5KE8.2A	1.5KE8.2CA
1.5KE9.1A	1.5KE9.1CA	7.78	8.65	9.55	1.0	13.4	111.9	50	1.5KE9.1A	1.5KE9.1CA
1.5KE10A	1.5KE10CA	8.55	9.50	10.5	1.0	14.5	103.4	10	1.5KE10A	1.5KE10CA
1.5KE11A	1.5KE11CA	9.40	10.5	11.6	1.0	15.6	96.1	5	1.5KE11A	1.5KE11CA
1.5KE12A	1.5KE12CA	10.2	11.4	12.6	1.0	16.7	89.8	5	1.5KE12A	1.5KE12CA
1.5KE13A	1.5KE13CA	11.1	12.4	13.7	1.0	18.2	82.4	5	1.5KE13A	1.5KE13CA
1.5KE15A	1.5KE15CA	12.8	14.3	15.8	1.0	21.2	70.7	5	1.5KE15A	1.5KE15CA
1.5KE16A	1.5KE16CA	13.6	15.2	16.8	1.0	22.5	67.0	5	1.5KE16A	1.5KE16CA
1.5KE18A	1.5KE18CA	15.3	17.1	18.9	1.0	25.5	59.5	5	1.5KE18A	1.5KE18CA
1.5KE20A	1.5KE20CA	17.1	19.0	21.0	1.0	27.7	54.0	5	1.5KE20A	1.5KE20CA
1.5KE22A	1.5KE22CA	18.8	20.9	23.1	1.0	30.6	49.0	5	1.5KE22A	1.5KE22CA
1.5KE24A	1.5KE24CA	20.5	22.8	25.2	1.0	33.2	45.0	5	1.5KE24A	1.5KE24CA
1.5KE27A	1.5KE27CA	23.1	25.7	28.4	1.0	37.5	40.0	5	1.5KE27A	1.5KE27CA
1.5KE30A	1.5KE30CA	25.6	28.5	31.5	1.0	41.4	36.0	5	1.5KE30A	1.5KE30CA
1.5KE33A	1.5KE33CA	28.2	31.4	34.7	1.0	45.7	33.0	5	1.5KE33A	1.5KE33CA
1.5KE36A	1.5KE36CA	30.8	34.2	37.8	1.0	49.9	30.0	5	1.5KE36A	1.5KE36CA
1.5KE39A	1.5KE39CA	33.3	37.1	41.0	1.0	53.9	28.0	5	1.5KE39A	1.5KE39CA
1.5KE43A	1.5KE43CA	36.8	40.9	45.2	1.0	59.3	25.3	5	1.5KE43A	1.5KE43CA
1.5KE47A	1.5KE47CA	40.2	44.7	49.4	1.0	64.8	23.2	5	1.5KE47A	1.5KE47CA
1.5KE51A	1.5KE51CA	43.6	48.5	53.6	1.0	70.1	21.4	5	1.5KE51A	1.5KE51CA
1.5KE56A	1.5KE56CA	47.8	53.2	58.8	1.0	77.0	19.5	5	1.5KE56A	1.5KE56CA
1.5KE62A	1.5KE62CA	53.0	58.9	65.1	1.0	85.0	17.7	5	1.5KE62A	1.5KE62CA
1.5KE68A	1.5KE68CA	58.1	64.6	71.4	1.0	92.0	16.3	5	1.5KE68A	1.5KE68CA
1.5KE75A	1.5KE75CA	64.1	71.3	78.8	1.0	103.0	14.6	5	1.5KE75A	1.5KE75CA
1.5KE82A	1.5KE82CA	70.1	77.9	86.1	1.0	113.0	13.3	5	1.5KE82A	1.5KE82CA
1.5KE91A	1.5KE91CA	77.8	86.5	95.5	1.0	125.0	12.0	5	1.5KE91A	1.5KE91CA
1.5KE100A	1.5KE100CA	85.5	95.0	105.0	1.0	137.0	11.0	5	1.5KE100A	1.5KE100CA
1.5KE110A	1.5KE110CA	94.0	105.0	116.0	1.0	152.0	9.9	5	1.5KE110A	1.5KE110CA
1.5KE120A	1.5KE120CA	102.0	114.0	126.0	1.0	165.0	9.1	5	1.5KE120A	1.5KE120CA
1.5KE130A	1.5KE130CA	111.0	124.0	137.0	1.0	179.0	8.4	5	1.5KE130A	1.5KE130CA
1.5KE150A	1.5KE150CA	128.0	143.0	158.0	1.0	207.0	7.2	5	1.5KE150A	1.5KE150CA
1.5KE160A	1.5KE160CA	136.0	152.0	168.0	1.0	219.0	6.8	5	1.5KE160A	1.5KE160CA
1.5KE170A	1.5KE170CA	145.0	162.0	179.0	1.0	234.0	6.4	5	1.5KE170A	1.5KE170CA
1.5KE180A	1.5KE180CA	154.0	171.0	189.0	1.0	246.0	6.1	5	1.5KE180A	1.5KE180CA
1.5KE200A	1.5KE200CA	171.0	190.0	210.0	1.0	274.0	5.5	5	1.5KE200A	1.5KE200CA
1.5KE220A	1.5KE220CA	185.0	209.0	231.0	1.0	328.0	4.6	5	1.5KE220A	1.5KE220CA
1.5KE250A	1.5KE250CA	214.0	237.0	263.0	1.0	344.0	4.4	5	1.5KE250A	1.5KE250CA
1.5KE300A	1.5KE300CA	256.0	285.0	315.0	1.0	414.0	3.6	5	1.5KE300A	1.5KE300CA
1.5KE350A	1.5KE350CA	300.0	332.0	368.0	1.0	482.0	3.1	5	1.5KE350A	1.5KE350CA
1.5KE400A	1.5KE400CA	342.0	380.0	420.0	1.0	548.0	2.7	5	1.5KE400A	1.5KE400CA
1.5KE440A	1.5KE440CA	376.0	418.0	462.0	1.0	602.0	2.5	5	1.5KE440A	1.5KE440CA

- Note 1. V_{BR} measured after I_T applied for 300IS, I_T =square wave pulse or equivalent
 2. Surge current waveform per Fig. 3 and derated per Fig. 2
 3. For bi-directional types having V_{RWM} of 10 volts and less, the I_R limit is doubled
 4. Suffix 'C' denotes bi-directional devices. Suffix 'A' denotes 5% tolerance devices, no suffix denotes 10% tolerance devices.
 5. All terms and symbols are consistent with ANS/IEEE C62.35



Rating and characteristic curves (1.5KE SERIES)

FIG.1 - PEAK PULSE POWER RATING CURVE

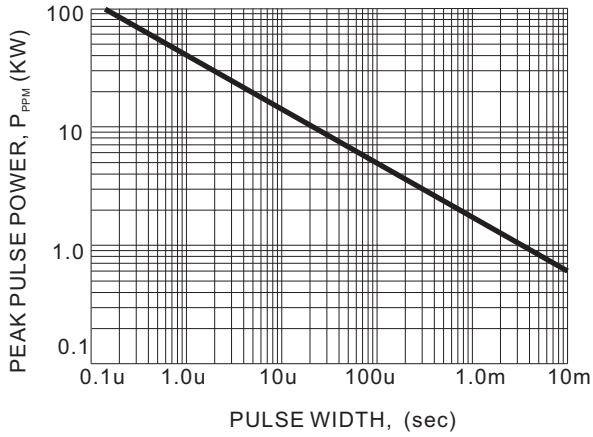

FIG.2 - PULSE DERATING CURVE

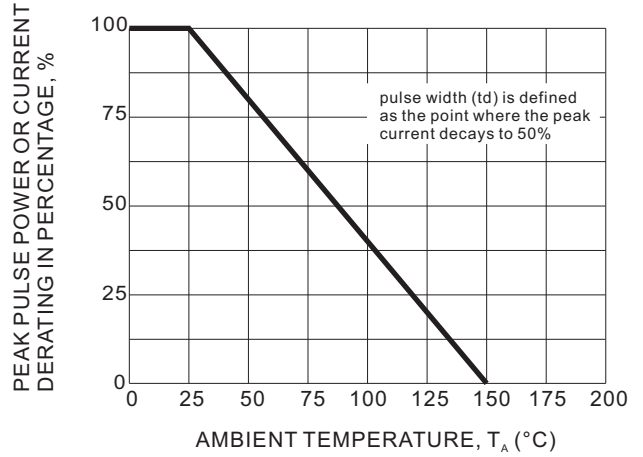

FIG.3 - PULSE WAVEFORM

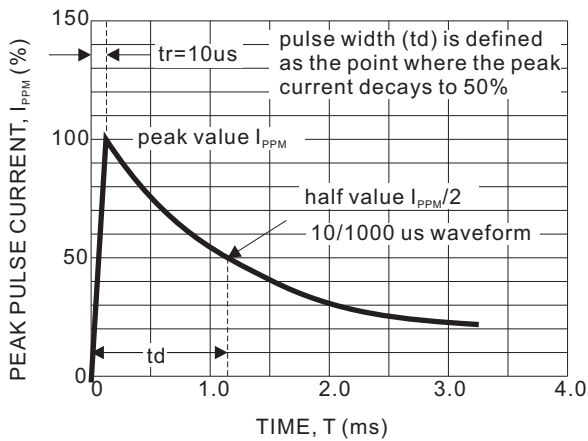

FIG.4 - TYPICAL JUNCTION CAPACITANCE

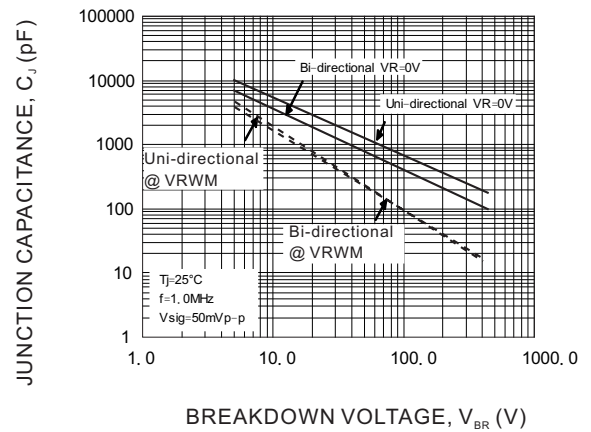

FIG.5 - STEADY STATE POWER DERATING CURVE

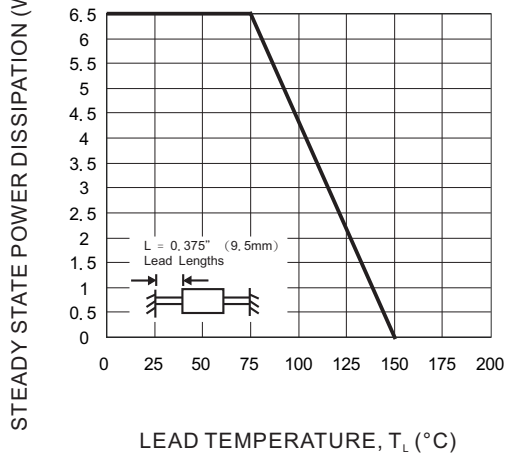
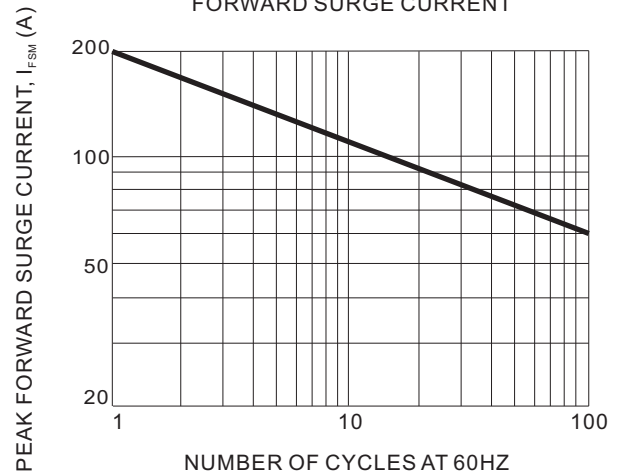





FIG.6 - MAXIMUM NON-REPETITIVE FORWARD SURGE CURRENT



1.5KE SERIES

Pinning information

Pin	Simplified outline	Symbol
Uni-Directional Pin1 cathode Pin2 anode		
Bi-Directional		

Taping & bulk specifications for AXIAL devices

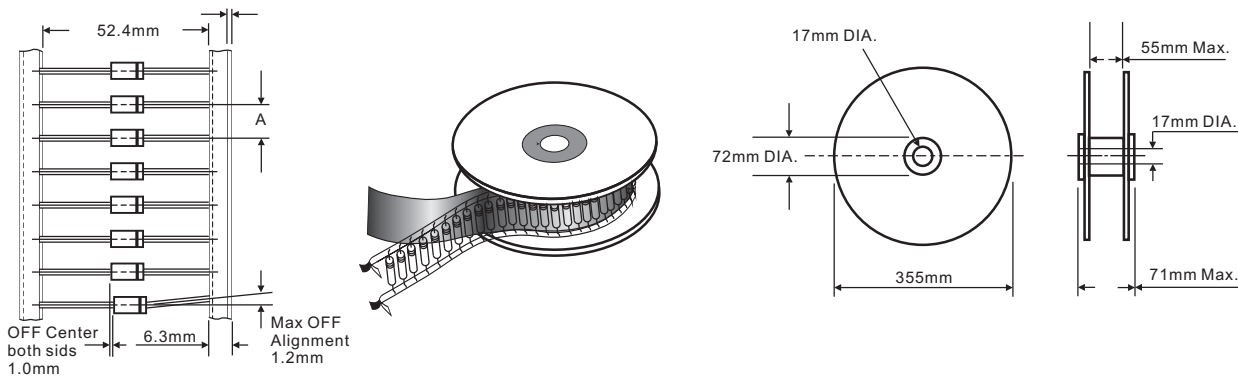

REEL PACKING

DEVICE CASE TYPE	Q'TY 1 (PCS / REEL)	COMPONENT SPACING "A" in FIG. A	CARTON SIZE (m/m)	Q'TY 2 (PCS / CARTON)	APPROX. CROSS WEIGHT(kg)
DO-201AE	1,200	10 mm	360 * 340 * 370	4,800	9.1

AMMO PACKING

DEVICE CASE TYPE	Q'TY 1 (PCS / BOX)	INNER BOX SIZE (m/m)	CARTON SIZE (m/m)	Q'TY 2 (PCS / CARTON)	APPROX. CROSS WEIGHT(kg)
DO-201AE	1,200	260 * 83 * 160	440 * 270 * 340	12,000	17.0

1.5KE SERIES

BULK PACKING

DEVICE CASE TYPE	Q'TY 1 (PCS / BOX)	INNER BOX SIZE (m/m)	CARTON SIZE (m/m)	Q'TY 2 (PCS / CARTON)	APPROX. CROSS WEIGHT(kg)
DO-201AE	500	305 * 73 * 40	347 * 320 * 271	12,000	16.4

Suggested thermal profiles for soldering processes

1. Lead free temperature profile wave-soldering

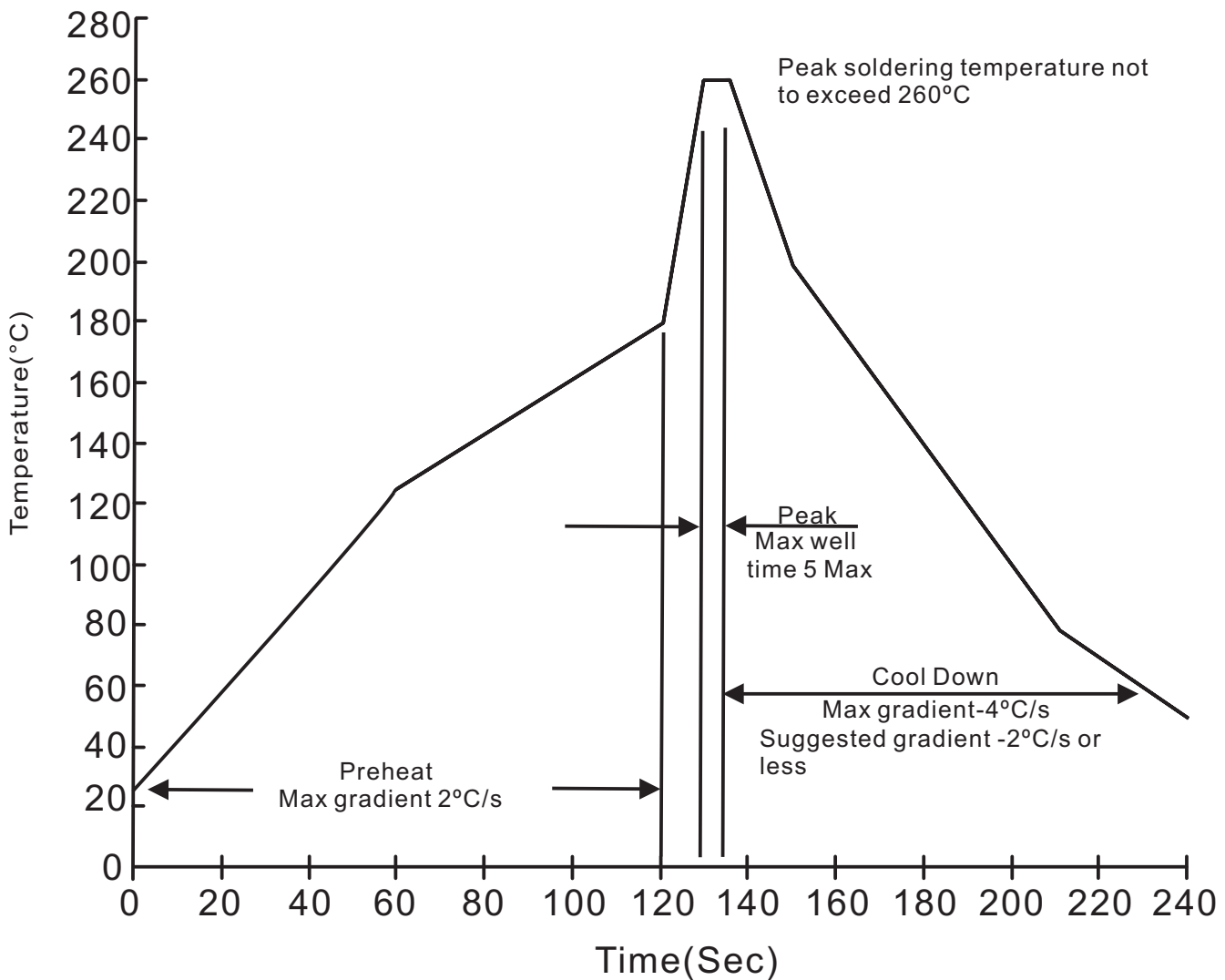

1.5KE SERIES

High reliability test capabilities

Item Test	Conditions	Reference
1. Solder Resistance	at $260\pm 5^{\circ}\text{C}$ for $10\pm 2\text{sec}$. immerse body into solder $1/16''\pm 1/32''$	MIL-STD-750D METHOD-2031
2. Solderability	at $245\pm 5^{\circ}\text{C}$ for 5 sec.	MIL-STD-202F METHOD-208
3. Pull Test	1.5kg in axial lead direction for 10 sec.	MIL-STD-750D METHOD-2036
4. Bend Lead	1.5kg weight applied to each lead bending arc $90^{\circ}\pm 5^{\circ}$ for 3 times.	MIL-STD-750D METHOD-2036
5. High Temperature Reverse Bias	$V_{\text{RWM}}=80\%$ rate at $T_{\text{J}}=150^{\circ}\text{C}$ for 168 hrs.	MIL-STD-750D METHOD-1038
6. Pressure Cooker	$15P_{\text{SIG}}$ at $T_{\text{A}}=121^{\circ}\text{C}$ for 4 hrs.	JESD22-A102
7. Temperature Cycling	-55°C to $+125^{\circ}\text{C}$ dwelled for 30 min. and transferred for 5min. total 10 cycles.	MIL-STD-750D METHOD-1051
8. Humidity	at $T_{\text{A}}=85^{\circ}\text{C}$, RH=85% for 1000hrs.	MIL-STD-750D METHOD-1021
9. High Temperature Storage Life	at 175°C for 1000 hrs.	MIL-STD-750D METHOD-1031

X-ON Electronics

Largest Supplier of Electrical and Electronic Components

Click to view similar products for [ESD Suppressors / TVS Diodes](#) category:

Click to view products by [Formosa](#) manufacturer:

Other Similar products are found below :

[60KS200C](#) [D18V0L1B2LP-7B](#) [D5V0F4U5P5-7](#) [NTE4902](#) [P4KE27CA](#) [P6KE11CA](#) [P6KE39CA-TP](#) [P6KE8.2A](#) [JANTX1N6053A](#)
[SA110CA](#) [SA60CA](#) [SA64CA](#) [SMBJ12CATR](#) [SMBJ33CATR](#) [SMBJ8.0A](#) [ESD105-B1-02EL E6327](#) [ESD112-B1-02EL E6327](#)
[ESD119B1W01005E6327XTSA1](#) [ESD5V0L1B02VH6327XTSA1](#) [ESD7451N2T5G](#) [19180-510](#) [CPDT-5V0USP-HF](#) [3.0SMCJ33CA-F](#)
[3.0SMCJ36A-F](#) [HSPC16701B02TP](#) [JANTX1N6126A](#) [JANTX1N6462](#) [JANTX1N6465](#) [USB50805e3/TR7](#) [D3V3Q1B2DLP3-7](#)
[D55V0M1B2WS-7](#) [DRTR5V0U4SL-7](#) [SCM1293A-04SO](#) [ESD200-B1-CSP0201 E6327](#) [SM12-7](#) [SM1605E3/TR13](#) [SMLJ45CA-TP](#) [CEN955](#)
[W/DATA](#) [82350120560](#) [VESD12A1A-HD1-GS08](#) [CPDUR5V0R-HF](#) [CPDQC5V0U-HF](#) [CPDQC5V0USP-HF](#) [CPDQC5V0-HF](#) [D1213A-](#)
[01LP4-7B](#) [ESD101-B1-02EL E6327](#) [824500181](#) [MMAD1108/TR13](#) [5KP100A](#) [5KP15A](#)