

SR320 THRU SR3200

3.0A Axial Leaded Schottky Barrier Rectifiers - 20V-200V

Features

- Axial lead type devices for through hole design
- Low power loss, high efficiency.
- High current capability, low forward voltage drop.
- High surge capability.
- Guardring for overvoltage protection.
- Ultra high-speed switching.
- Silicon epitaxial planar chip, metal silicon junction.
- Lead-free parts meet environmental standards of MIL-STD-19500 /228
- Suffix "-H" for Halogen-free part, ex.SR320-H

Mechanical data

- Epoxy : UL94-V0 rated flame retardant
- Case : Molded plastic, DO-201AD
- Lead : Axial leads, solderable per MIL-STD-202, Method 208 guaranteed
- Polarity: Color band denotes cathode end
- Mounting Position : Any

Package outline

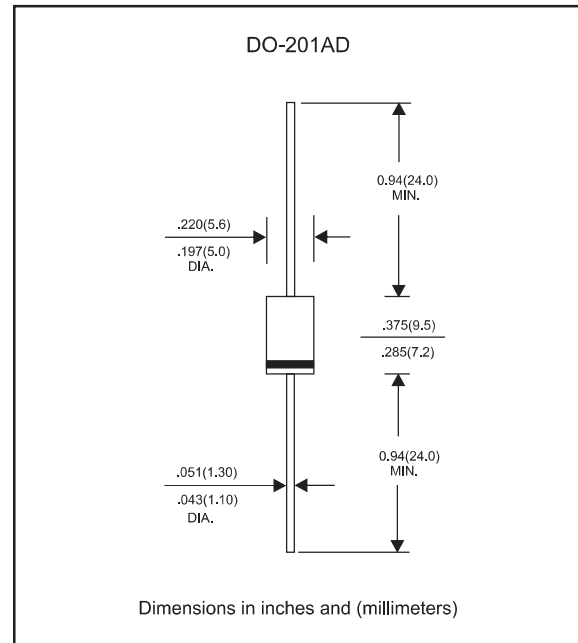

Maximum ratings and Electrical Characteristics (AT $T_A=25^\circ\text{C}$ unless otherwise noted)

PARAMETER	CONDITIONS	Symbol	MIN.	TYP.	MAX.	UNIT
Forward rectified current	See Fig.2	I_o			3.0	A
Forward surge current	8.3ms single half sine-wave (JEDEC method)	I_{FSM}			80	A
Reverse current	$V_R = V_{RRM}$ $T_J = 25^\circ\text{C}$	I_R			0.5	mA
	$V_R = V_{RRM}$ $T_J = 100^\circ\text{C}$				30	
Thermal resistance	Junction to ambient	$R_{\theta JA}$		40		$^\circ\text{C/W}$
	Junction to lead	$R_{\theta JL}$		10		$^\circ\text{C/W}$
Diode junction capacitance	f=1MHz and applied 4V DC reverse voltage	C_J		250		pF
Storage temperature		T_{STG}	-65		+175	$^\circ\text{C}$

SYMBOLS	V_{RRM}^{*1} (V)	V_{RMS}^{*2} (V)	V_R^{*3} (V)	V_F^{*4} (V)	Operating temperature T_J , ($^\circ\text{C}$)
SR320	20	14	20	0.55	-55 to +125
SR340	40	28	40		
SR345	45	32	45		
SR350	50	35	50	0.70	-55 to +150
SR360	60	42	60		
SR380	80	56	80	0.85	
SR3100	100	70	100		
SR3150	150	105	150	0.92	
SR3200	200	140	200		

*1 Repetitive peak reverse voltage

*2 RMS voltage

*3 Continuous reverse voltage

*4 Maximum forward voltage@ $I_F=3.0A$

Rating and characteristic curves (SR320 THRU SR3200)

FIG.1-TYPICAL FORWARD CURRENT DERATING CURVE

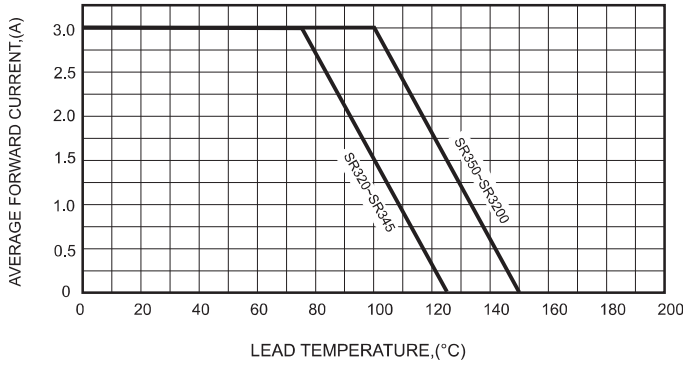

FIG.2-TYPICAL FORWARD CHARACTERISTICS

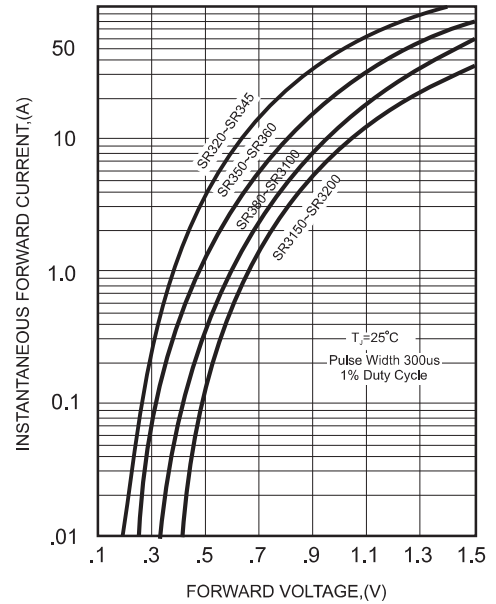

FIG.3-MAXIMUM NON-REPETITIVE FORWARD SURGE CURRENT

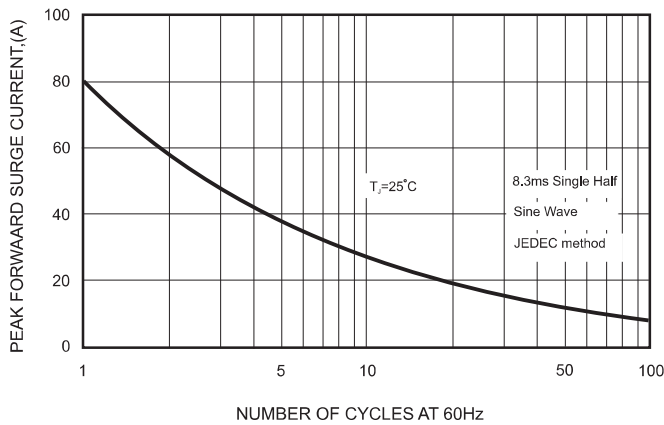

FIG.4-TYPICAL JUNCTION CAPACITANCE

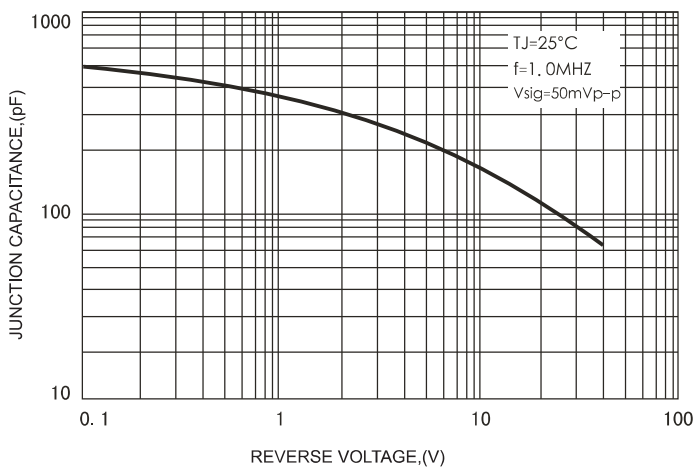
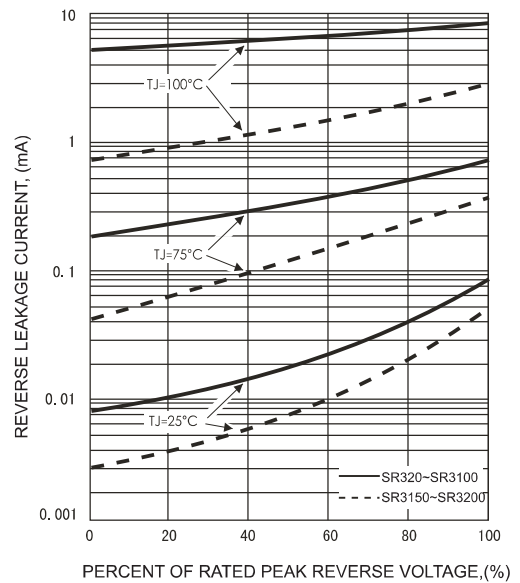

FIG.5 - TYPICAL REVERSE CHARACTERISTICS



SR320 THRU SR3200

Pinning information

Pin	Simplified outline	Symbol
Pin1 cathode Pin2 anode		

Marking

Type number	Marking code	Example	
SR320	SR320	For Halogen Device 	For Halogen-free Device
SR330	SR330		
SR340	SR340		
SR350	SR350		
SR360	SR360		
SR380	SR380		
SR3100	SR3100		
SR3150	SR3150		
SR3200	SR3200		

Taping specifications for AXIAL devices

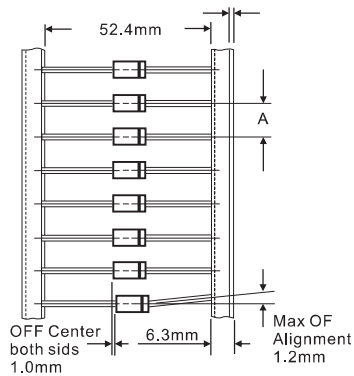

AMMO PACKING

DEVICE CASE TYPE	Q'TY 1 (PCS / BOX)	INNER BOX SIZE (m/m)	CARTON SIZE (m/m)	Q'TY 2 (PCS / CARTON)	APPROX. CROSS WEIGHT(kg)
DO-201AD	1,250	258 * 75 * 143	405 * 270 * 320	12,500	14.0

X-ON Electronics

Largest Supplier of Electrical and Electronic Components

Click to view similar products for [Schottky Diodes & Rectifiers](#) category:

Click to view products by [Formosa](#) manufacturer:

Other Similar products are found below :

[CUS06\(Te85L,Q,M\)](#) [MA4E2039](#) [D1FH3-5063](#) [MBR0530L-TP](#) [MBR10100CT-BP](#) [MBR30H100MFST1G](#) [MMBD301M3T5G](#) [PMAD1103-LF](#) [PMAD1108-LF](#) [RB160M-50TR](#) [RB520S-30](#) [RB551V-30](#) [DD350N18K](#) [DZ435N40K](#) [DZ600N16K](#) [BAS16E6433HTMA1](#) [BAS 3010S-02LRH E6327](#) [BAT 54-02LRH E6327](#) [IDL02G65C5XUMA1](#) [NSR05F40QNXT5G](#) [NSVR05F40NXT5G](#) [JANS1N6640](#) [SB07-03C-TB-H](#) [SB1003M3-TL-W](#) [SBAT54CWT1G](#) [SBM30-03-TR-E](#) [SBS818-TL-E](#) [SK32A-LTP](#) [SK33A-TP](#) [SK34A-TP](#) [SK34B-TP](#) [SMD1200PL-TP](#) [ACDBN160-HF](#) [SS3003CH-TL-E](#) [STPS30S45CW](#) [PDS3100Q-7](#) [GA01SHT18](#) [CRS10I30A\(Te85L,QM\)](#) [MBR1240MFST1G](#) [MBRB30H30CT-1G](#) [BAS28E6433HTMA1](#) [BAS 70-02L E6327](#) [HSB123JTR-E](#) [JANTX1N5712-1](#) [VS-STPS40L45CW-N3](#) [DD350N12K](#) [SB007-03C-TB-E](#) [SB10015M-TL-E](#) [SB1003M3-TL-E](#) [SK110-LTP](#)