



PRODUCT SPECIFICATION

Model No.: FYLS-0402CXXC

Features:
<ul style="list-style-type: none"> ■ SMD Type ■ Size (mm):1.00*0.50*0.45 ■ Lens Color: Water clear. ■ Viewing Angle(2θ^{1/2}):130° ■ SMT package ■ Suitable for all SMT assembly and soldering method ■ Pb-free Reflow soldering application ■ RoHS Compliant ■ MSL:4

Applications:
<ul style="list-style-type: none"> ■ Light Strips ■ LCD Backlight ■ Decorative lighting ■ Indicators ■ Interior automotive ■ Illuminations ■ Mobile Phones



CUSTOMER APPROVED SIGNATURES	APPROVED BY	SALES BY	PREPARED BY
			

NINGBO FORYARD OPTOELECTRONICS CO.,LTD.

Add:No. 666 Jinghua Road, Hi-tech Park, Ningbo, Zhejiang, China

Zip:315103

Tel: 0086-574-87933652 87927870 87922206

Fax: 0086-574-87927917

E-mail:Sales@foryard.com (General)

Model No.: FYLS-0402CXXC

■ Mechanical Dimensions

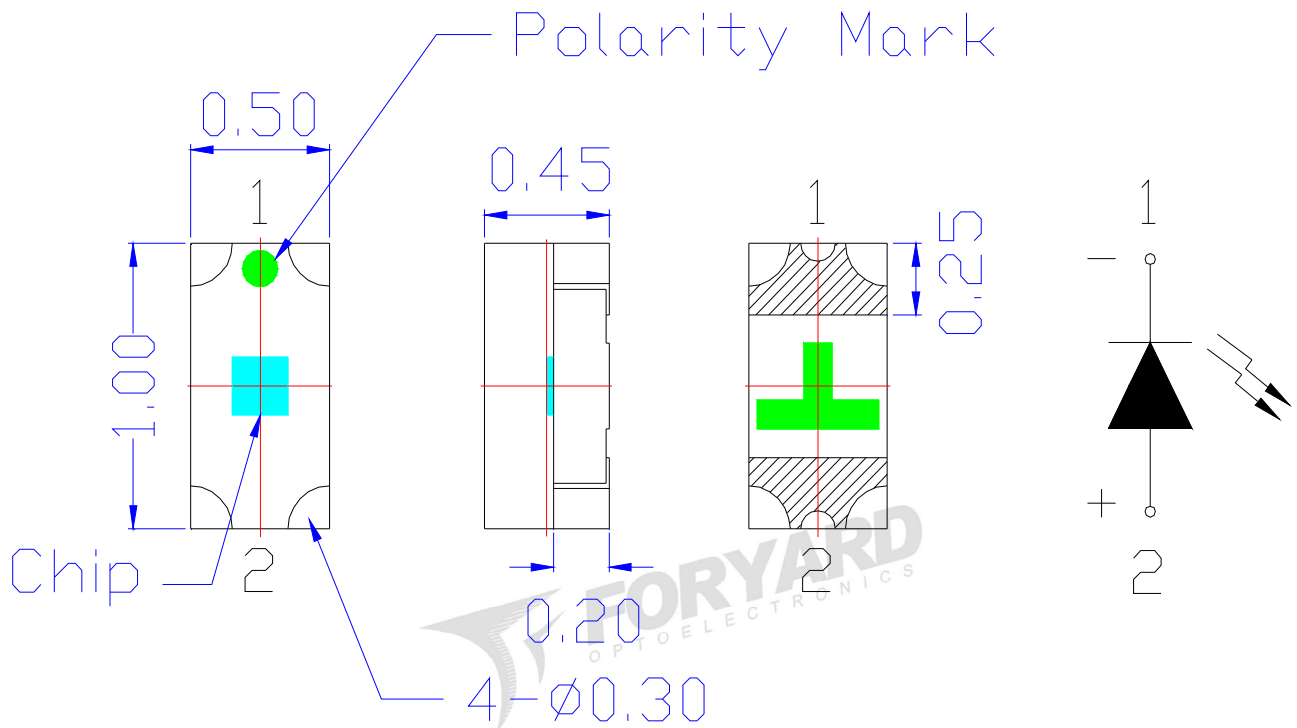

■ Recommend Soldering pad design(unit=mm)

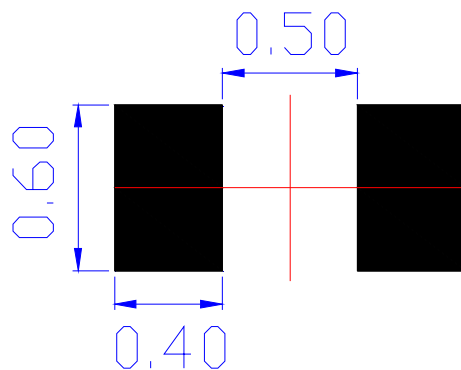

Notes:

1. Dimension in millimeter, tolerance is ± 0.10 .
2. Angle: $\pm 5^\circ$
3. The specifications, characteristics and technical data described in the datasheet are subject to change without prior notice.
4. The drawing is different from the actual one, please refer to the sample.

Model No.: FYLS-0402CXXC

■ Absolute maximum ratings

Parameter	Symbol	MAX.		Unit
		AlGaInP	InGaN/GaN	
Power Dissipation	PD	78	100	mW
Peak Forward Current*	IFP	30	25	mA
Continuous Forward Current	IF	100	100	mA
Reverse Voltage	VR	5		V
Reverse Current (VR=5V)	IR	10		u A
Operating Temperature Range	Topr	-40~ +85		℃
Storage Temperature Range	Tstg	-40~ +85		℃

*1/10 Duty Cycle, 0.1ms Pulse Width

■ Electrical-Optical Characteristics

● Color Code & Chip Characteristics:(Test Condition:IF=20mA)

(Ta=25℃)

Model No.:	Emitting Color	Dice Material	Peak Wave Length(λP)	Peak Wave Length(λd) nm			Spectral Line halfwidth	Forward Voltage(VF) Unit:V			Luminous Intensity (Iv) Unit:mcd		
			nm	Min.	Typ.	Max.	(Δλ1/2) nm	Min.	Typ.	Max.	Min.	Typ.	Max.
Ultra brightness													
FYLS-0402CKURC	Ultra Red	AlGaInP	645	623	632	640	20	1.70	2.00	2.40	57	72	145
FYLS-0402CKUYC	Ultra Yellow	AlGaInP	593	586	592	596	20	1.70	2.00	2.40	90	115	180
FYLS-0402CKUGC	Ultra Yellow Green	AlGaInP	570	568	572	576	30	1.70	2.00	2.40	18	28.5	45
FYLS-0402CPGC	Purea Green	InGaN/GaN	520	514	521.5	529	36	2.60	3.00	3.50	285	550	650
FYLS-0402CUBC	Ultra Blue	InGaN/GaN	468	463.5	470	476	30	2.60	3.00	3.50	72	115	180

■ Material

Item	Reflector	Wire	Encapsulate
Material	/	Gold	Epoxy

Note:

- 1.Luminous Intensity is based on the Foryard standards.
- 2.Pay attention about static for InGaN

Model No.: FYLS-0402CXXC

■ The Luminous Intensity Grade of Products(Unit: mcd) ;Test Condition: If=20mA,Ta=25℃

A		B		C		D		E		F	
A1	A2	B1	B2	C1	C2	D1	D2	E1	E2	F1	F2
0.10	0.20	0.40	0.70	1.20	2.20	3.60	5.10	7.20	9.00	11.50	14.50
0.20	0.40	0.70	1.20	2.20	3.60	5.10	7.20	9.00	11.50	14.50	18.00

G		H		J		K		L		M	
G1	G2	H1	H2	J1	J2	K1	K2	L1	L2	M1	M2
18.00	22.50	28.50	36.00	45.00	57.00	72.00	90.00	115.00	145.00	180.00	225.00
22.50	28.50	36.00	45.00	57.00	72.00	90.00	115.00	145.00	180.00	225.00	285.00

N		P		Q		R		SA		SB	
N1	N2	P1	P2	Q1	Q2	R1	R2	S1	S2	S3	S4
285.00	360.00	450.00	550.00	650.00	750.00	850.00	950.00	1050.00	1150.00	1250.00	1350.00
360.00	450.00	550.00	650.00	750.00	850.00	950.00	1050.00	1150.00	1250.00	1350.00	1450.00

SC		TA		TB		TC		UA		UB	
S5	S6	T1	T2	T3	T4	T5	T6	U1	U2	U3	U4
1450.00	1550.00	1650.00	1750.00	1850.00	1950.00	2050.00	2250.00	2450.00	2650.00	2850.00	3050.00
1550.00	1650.00	1750.00	1850.00	1950.00	2050.00	2250.00	2450.00	2650.00	2850.00	3050.00	3350.00

UC		VA		VB		VC		WA		WB	
U5	U6	V1	V2	V3	V4	V5	V6	W1	W2	W3	W4
3350.00	3650.00	3950.00	4250.00	4650.00	5050.00	5550.00	6050.00	6650.00	7250.00	7950.00	8650.00
3650.00	3950.00	4250.00	4650.00	5050.00	5550.00	6050.00	6650.00	7250.00	7950.00	8650.00	9450.00

WC		XA		XB		XC	
W5	W6	X1	X2	X3	X4	X5	X6
9450.00	10250.00	11250.00	13250.00	16250.00	19250.00	23250.00	27250.00
10250.00	11250.00	13250.00	16250.00	19250.00	23250.00	27250.00	32250.00

Tolerance of measurement of luminous intensity is ±15%

■ Forward Voltage Grade of Products (Unit: V); Test Condition: If=20mA,Ta=25℃

1	2	3	4	5	6	7	8	9	10	11	12
1.40	1.50	1.60	1.70	1.80	1.90	2.00	2.10	2.20	2.30	2.40	2.50
1.50	1.60	1.70	1.80	1.90	2.00	2.10	2.20	2.30	2.40	2.50	2.60

13	14	15	16	17	18	19	20	21	22	23	24
2.60	2.70	2.80	2.90	3.00	3.10	3.20	3.30	3.40	3.50	3.60	3.70
2.70	2.80	2.90	3.00	3.10	3.20	3.30	3.40	3.50	3.60	3.70	3.80

Tolerance of measurement of forward voltage is ±0.1V

Model No.: FYLS-0402CXXC

■ Dominate Wavelength Grade of Products (Unit: nm); Test Condition: If=20mA, Ta=25°C

Red/Ultra Red			
UR			
1	2	3	4
620.00	623.00	627.00	632.00
623.00	627.00	632.00	640.00

Yellow /Ultra Yellow					
Y/UY					
1	2	3	4	5	6
584.00	586.00	588.00	590.00	592.00	594.00
586.00	588.00	590.00	592.00	594.00	596.00

Yellow Green/ Ultra Yellow Green				
G/UG				
0	1	2	3	4
568.00	570.00	572.00	574.00	576.00
570.00	572.00	574.00	576.00	578.00

Purea Green									
PG									
1	2	3	4	5	6	7	8	9	A
511.50	514.00	516.50	519.00	521.50	524.00	526.50	529.00	531.50	534.00
514.00	516.50	519.00	521.50	524.00	526.50	529.00	531.50	534.00	536.50

Ultra Blue					
UB					
0	1	2	3	4	5
460.00	463.50	466.00	468.50	471.00	473.50
463.50	466.00	468.50	471.00	473.50	476.00

Tolerance for each Dominate Wavelength bin is ±1nm

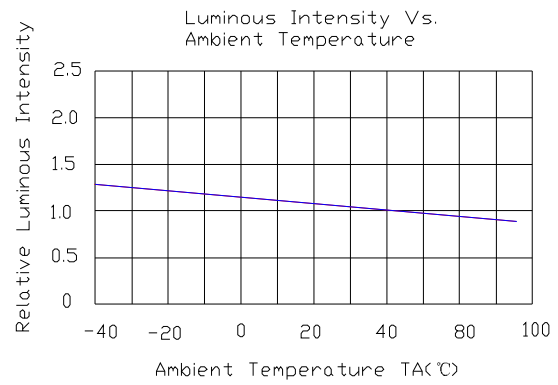
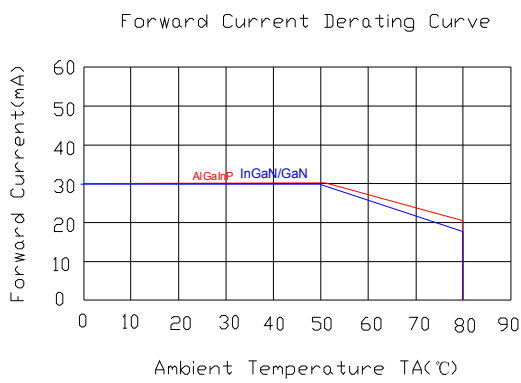
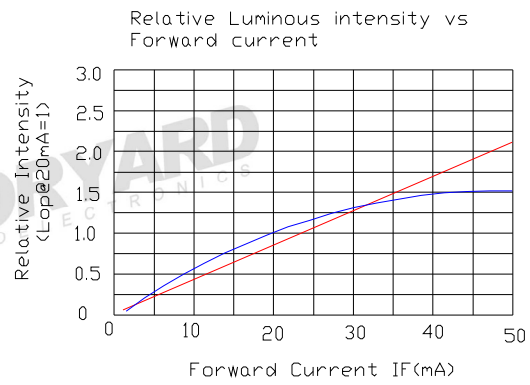
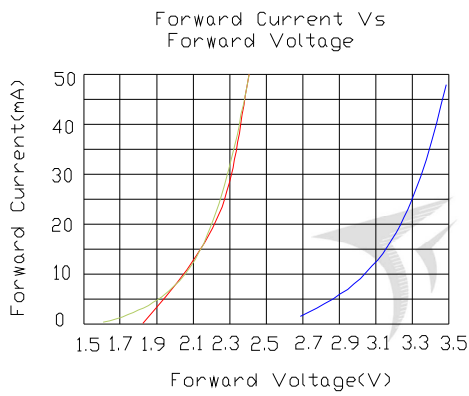
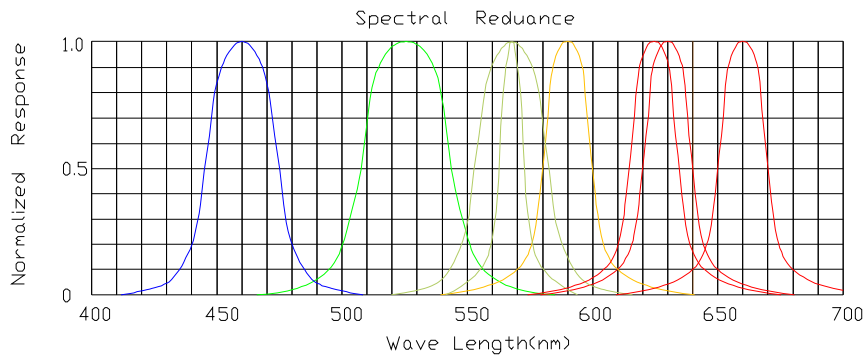
Model No.: FYLS-0402CXXC
Electrical-Optical Characteristics-

NOTE:25°C free air temperature unless otherwise specified

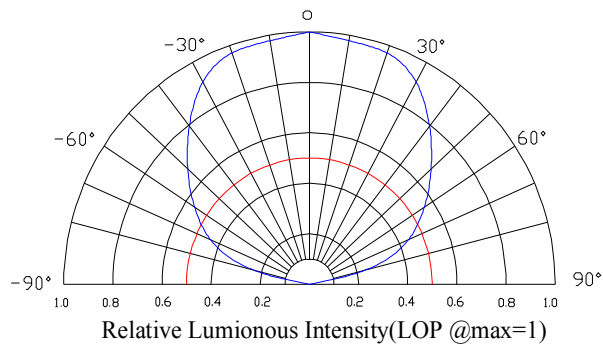
Radiation pattern-

Model No.: FYLS-0402CXXC

■ Package-

1. Reel Dimension

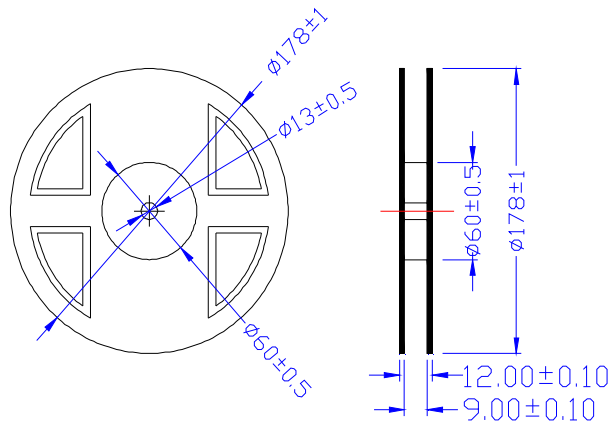

2. Tape Dimension

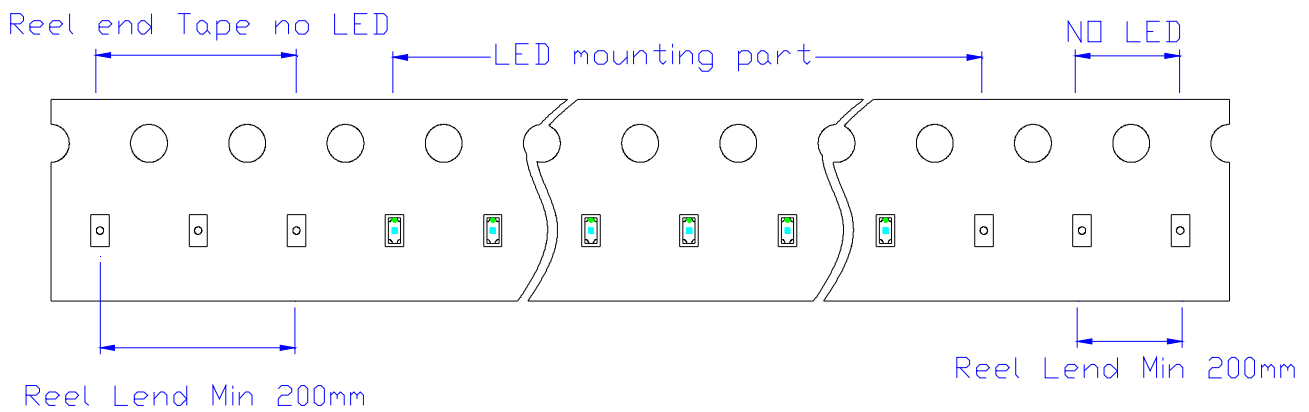
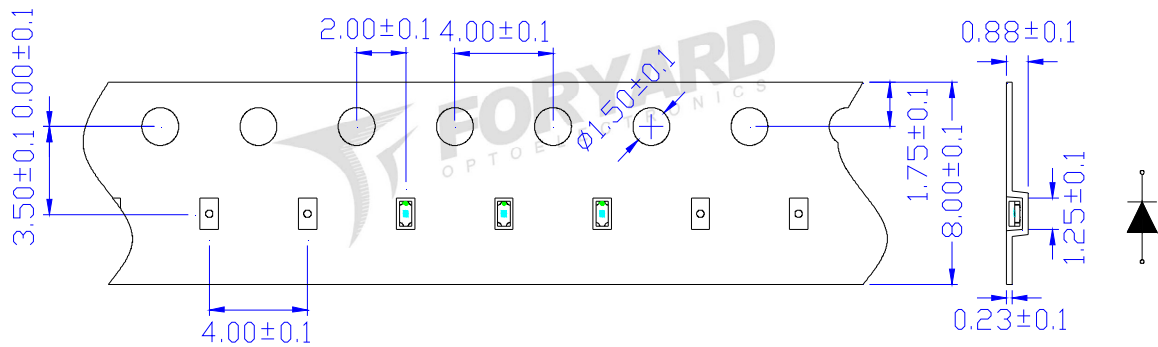

Notice:

1. Tolerance unless mentioned is $\pm 0.2\text{mm}$

Model No.:	FYLS-0402CXXC
Date / Rev.	2020.07.09 / A

Model No.: FYLS-0402CXXC

3. Packing Diagram

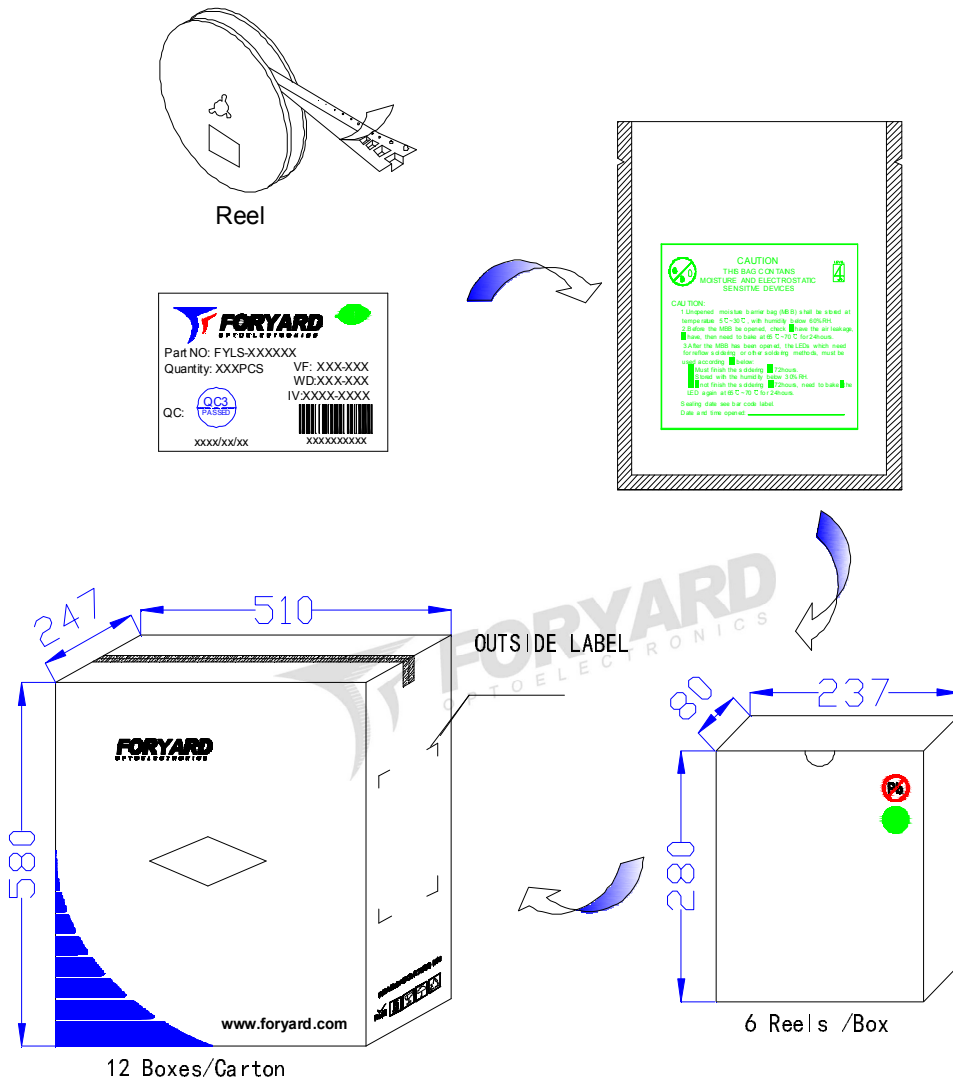
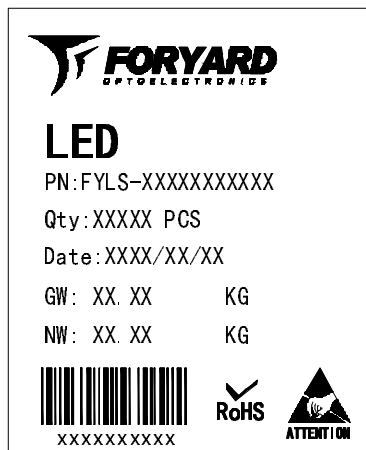
FORYARD
OPTOELECTRONICS

LED
PN: FYLS-XXXXXXXXXX
Qty: XXXXX PCS
Date: XXXX/XX/XX
GW: XX.XX KG
NW: XX.XX KG

XXXXXXXXXX

RoHS ATTENTION

OUTSIDE LABEL

Notice:

- 1.Quantity:5000 PCS/Reel
- 2.The specifications are subject to change without notice. Please contact us for updated information.

Model No.: FYLS-0402CXXC

■ Soldering Characteristics-

● Reflow Soldering

● Lead Solder

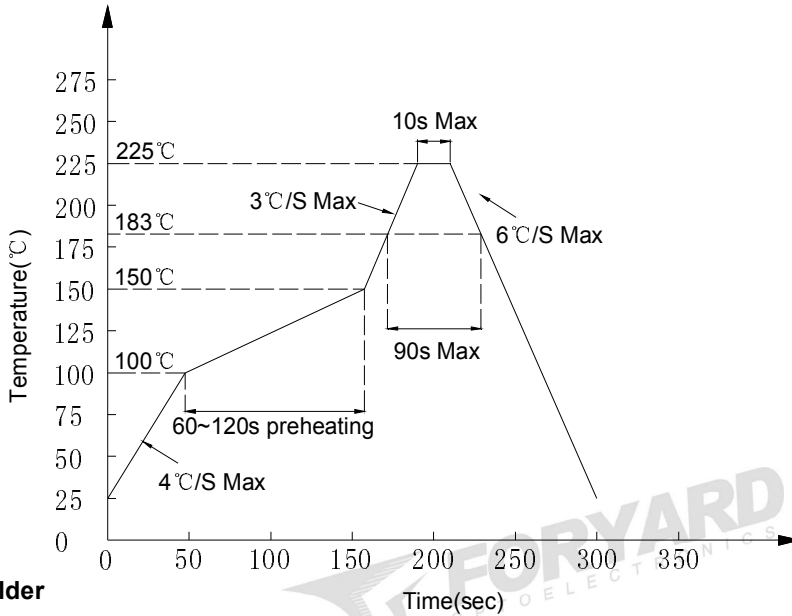

● Lead-free Solder

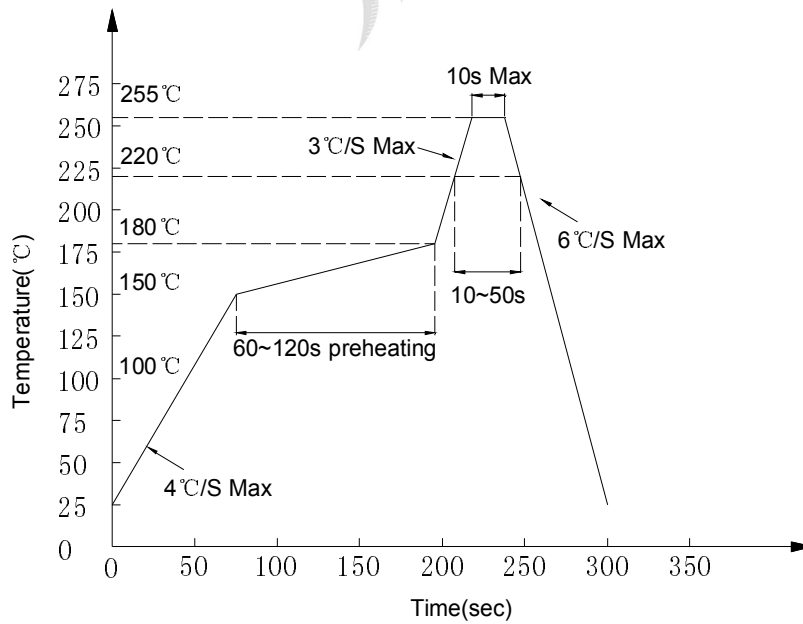

Notes:

1. Although the recommended soldering conditions are specified in above table, reflow or hand soldering at the lowest possible temperature is desired for the LEDs.
2. A rapid-rate process is not recommended for cooling the LEDs down from the peak temperature.
3. All temperatures refer to solder Pad.

● Hand Soldering

Soldering temperature	300°C Max. (25W Max.)	One time only
Soldering time	5 ±1sec	

Model No.: FYLS-0402CXXC

■ Handling of Silicone Resin LEDs-

● Handling Indications

When handling the product, do not touch it directly with bare hands as it may contaminate the surface and affect on optical characteristics. In the worst cases, excessive force to the product might result in catastrophic failure due to package damage and/or wire breakage.

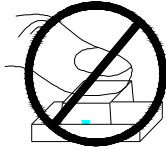

When handling the product with tweezers, LEDs should only be handled from the side and make sure that excessive force is not applied to the resin portion of the product. Failure to comply can cause the resin portion of the product to be cut, chipped, delaminated and/or deformed, and wire to be broken, and thus resulting in catastrophic failure.

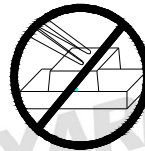
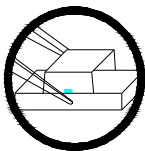

■ Recommended circuit-

• In designing a circuit, the current through each LED must not exceed the absolute maximum rating specified for each LED. It is recommended to use Circuit B which regulates the current flowing through each LED. In the meanwhile, when driving LED with a constant voltage in Circuit A, the current through the LEDs may vary due to the variation in forward voltage (VF) of the LEDs. In the worst case, some LED may be subjected to stresses in excess of the absolute maximum rating.

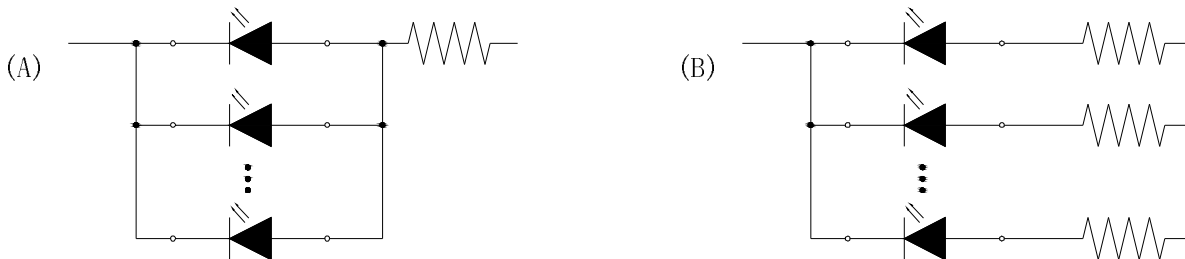

• This product should be operated in forward bias. A driving circuit must be designed so that the product is not subjected to either forward or reverse voltage while it is off. In particular, if a reverse voltage is continuously applied to the product; such operation can cause migration resulting in LED damage.

■ Storage-

● Storage Conditions

1. Unopened moisture barrier bag (MBB) shall be stored at temperature below 5°C~30°C, with humidity below 60%RH.
2. Before the MBB be opened, check if have the air leakage, if have, then need to bake at 65°C~70°C for 24hours.
3. After the MBB has been opened, the LEDs which need for reflow soldering or other soldering methods, must be used according to below:
 - a: Must finish the soldering in 72hours
 - b: Stored with the humidity below 30%RH
 - c: If not finish the soldering in 72hours, need to bake the LED again at 65°C~70°C for 24hours

X-ON Electronics

Largest Supplier of Electrical and Electronic Components

Click to view similar products for [Standard LEDs - SMD category](#):

Click to view products by [Foryard manufacturer](#):

Other Similar products are found below :

[LTST-C19GD2WT](#) [LTST-N683GBEW](#) [LTW-170ZDC](#) [LTW-M140SZS40](#) [598-8110-100F](#) [598-8170-100F](#) [598-8610-202F](#) [67-22VRVGC/TR8](#) [AAAF5060QBFSEEZGS](#) [ALMD-LB36-SV002](#) [APT1608QGW](#) [EASV1803BA0](#) [LG M67K-H1J2-24-0-2-R18-Z](#) [LS A676-P2S1-1](#) [SML-512VWT86A](#) [SML-LX0606SISUGC/A](#) [SML-LXL1307SRC-TR](#) [SML-LXR851SIUPGUBC](#) [LT1ED53A](#) [FAT801-S](#) [AM27ZGC03](#) [APB3025SGNC](#) [APFA3010SURKCGKQBDC](#) [APHK1608VGCA](#) [APT2012QGW](#) [CLX6D-FKB-CN1R1H1BB7D3D3](#) [LTST-008BGEW](#) [LTST-C250KGKT](#) [LTW-010DCG](#) [LTW-020ZDCG](#) [LTW-21TS5](#) [LTW-220DS5](#) [JANTXM19500/521-02](#) [UYGT801-S](#) [42-21UYC/S530-A3/TR8](#) [LO T67F-V1AB-24-1](#) [YGFR411-H](#) [SML-LX0402IC-TR](#) [CMDA20AYAA7D1S](#) [CMDA16AYDR7A1X](#) [339-1SURYGW/S530-A2](#) [598-8040-100F](#) [598-8070-100F](#) [598-8140-100F](#) [598-8610-200F](#) [EAST2012GA0](#) [SML-LXL1209SYC/ATR](#) [EASV3020YGA0](#) [EAST16086YA5](#) [CMD91-21VRC/TR7](#)