



安徽富信半导体科技有限公司

ANHUI FOSAN SEMICONDUCTOR TECHNOLOGY CO., LTD.

1SMA4728A-1SMA4777A

SMA Surface Mounted Zener Diode 表面贴装稳压二极管

■SMA(DO-214AC) Internal Configuration 内部结构

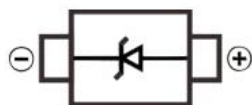

■Features 特点

Characteristic 特性参数	Symbol 符号	Max 最大值	Unit 单位
Power dissipation 耗散功率	$P_D(T_a=25^\circ\text{C})$	500	mW
Power dissipation 耗散功率	$P_D(T_L=75^\circ\text{C})$	1000	mW
Forward Voltage 正向电压	$V_F(@ I_F=200\text{mA})$	1.5	V
Reverse Voltage 反向电压	V_Z	3.3-330	V
Thermal Resistance J-L 结到管脚热阻	$R_{\theta JL}$	50	$^\circ\text{C}/\text{W}$
Thermal Resistance J-A 结到环境热阻	$R_{\theta JA}$	250	$^\circ\text{C}/\text{W}$
Junction and Storage Temperature 结温和储藏温度	T_J, T_{stg}	150 $^\circ\text{C}$, -55to+150 $^\circ\text{C}$	

ELECTRICAL CHARACTERISTICS	
SYMBOL	PARAMETER
V_Z	Reverse Zener voltage at I_{ZT}
I_{ZT}	Reverse current
Z_{ZT}	Maximum Zener impedance at I_{ZT}
I_{ZK}	Reverse current
Z_{ZK}	Maximum Zener impedance at I_{ZK}
I_R	Reverse leakage current at V_R
V_R	Reverse voltage
I_F	Forward current
V_F	Forward voltage at I_F
I_{ZM}	Maximum DC Zener current

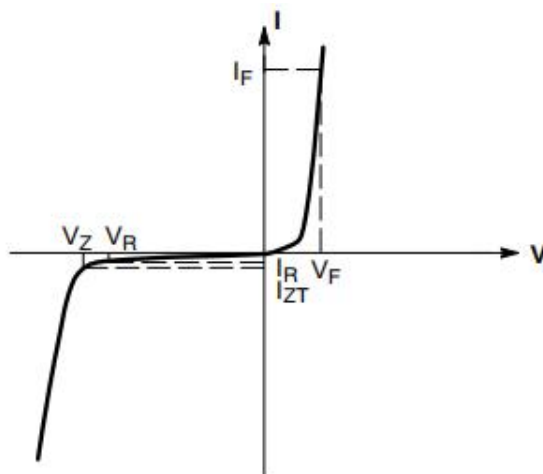

■Electrical Characteristics 电特性

($T_A=25^\circ\text{C}$ unless otherwise noted 如无特殊说明, 温度为 25 $^\circ\text{C}$)



安徽富信半导体科技有限公司

ANHUI FOSAN SEMICONDUCTOR TECHNOLOGY CO., LTD.

Type Number	V _Z (V)@I _{ZT}			I _{ZT} (mA)	Z _{ZT} (Ω) @I _{ZT}	I _R (uA) @V _R	V _R (V)	I _{ZRM} (mA)	Marking
	Nom.	Min.	Max.						
1SMA4728A	3.3	3.10	3.50	75	10	100	1	285	728A
1SMA4729A	3.6	3.40	3.80	69	10	100	1	263	729A
1SMA4730A	3.9	3.70	4.10	64	9.0	50	1	243	730A
1SMA4731A	4.3	4.06	4.56	58	9.0	25	1	219	731A
1SMA4732A	4.7	4.50	4.93	53	8.0	10	1	203	732A
1SMA4733A	5.1	4.84	5.36	49	7.0	10	1	186	733A
1SMA4734A	5.6	5.32	5.92	45	5.0	10	2	170	734A
1SMA4735A	6.2	5.86	6.51	41	2.0	10	3	154	735A
1SMA4736A	6.8	6.46	7.18	37	3.5	10	4	140	736A
1SMA4737A	7.5	7.12	7.88	34	4.0	10	5	127	737A
1SMA4738A	8.2	7.79	8.67	31	4.5	10	6	116	738A
1SMA4739A	9.1	8.60	9.59	28	5.0	10	7	104	739A
1SMA4740A	10	9.50	10.5	25	7.0	10	7	95	740A
1SMA4741A	11	10.4	11.6	23	8.0	5	8	86	741A
1SMA4742A	12	11.4	12.6	21	9.0	5	9	79	742A
1SMA4743A	13	12.4	14.1	19	10	5	10	71	743A
1SMA4744A	15	13.8	15.8	17	14	5	11	63	744A
1SMA4745A	16	15.2	17.1	16	16	5	12	58	745A
1SMA4746A	18	16.8	19.2	14	20	5	13	52	746A
1SMA4747A	20	19.0	21.2	13	22	5	15	47	747A
1SMA4748A	22	20.8	23.3	12	23	5	17	43	748A
1SMA4749A	24	22.8	26.0	11	25	5	18	38	749A
1SMA4750A	27	25.3	28.9	9.5	35	5	21	35	750A
1SMA4751A	30	28.2	32.0	8.5	40	5	23	31	751A
1SMA4752A	33	31.3	34.9	7.5	45	5	25	28	752A
1SMA4753A	36	34.2	37.9	7.0	50	5	27	26	753A
1SMA4754A	39	37.2	41.5	6.5	60	5	30	24	754A
1SMA4755A	43	40.9	45.6	6.0	70	1	32	22	755A
1SMA4756A	47	44.9	49.8	5.5	80	1	35	20	756A
1SMA4757A	51	48.6	54.0	5.0	95	1	38	18	757A
1SMA4758A	56	53.6	58.8	4.5	110	1	42	17	758A
1SMA4759A	62	58.9	65.6	4.0	125	1	47	15	759A
1SMA4760A	68	64.6	71.7	3.7	150	1	52	14	760A
1SMA4761A	75	71.2	78.8	3.3	175	1	56	12	761A
1SMA4762A	82	77.9	87.0	3.0	200	1	62	11	762A
1SMA4763A	91	86.0	96.0	2.8	250	1	69	10	763A
1SMA4764A	100	95.0	105	2.5	350	1	76	9.5	764A
1SMA4765A	110	104	116	2.3	450	1	84	8.6	765A
1SMA4766A	120	114	127	2.0	550	1	91	7.8	766A
1SMA4767A	135	125	142	1.9	700	1	100	7.0	767A
1SMA4768A	150	140	157	1.7	900	1	110	6.3	768A
1SMA4769A	165	155	172	1.6	1100	1	120	5.8	769A
1SMA4770A	180	170	191	1.4	1200	1	135	5.2	770A
1SMA4771A	200	189	211	1.2	1400	1	150	4.7	771A
1SMA4772A	220	209	231	1.0	1600	1	165	4.3	772A
1SMA4773A	240	229	251	1.0	1800	1	180	3.9	773A
1SMA4774A	260	249	271	1.0	2000	1	190	3.7	774A
1SMA4775A	280	269	291	1.0	2100	1	205	3.4	775A
1SMA4776A	300	289	315	1.0	2300	1	230	3.1	776A
1SMA4777A	330	313	346	1.0	2500	1	250	2.8	777A

■ Typical Characteristic Curve 典型特性曲线

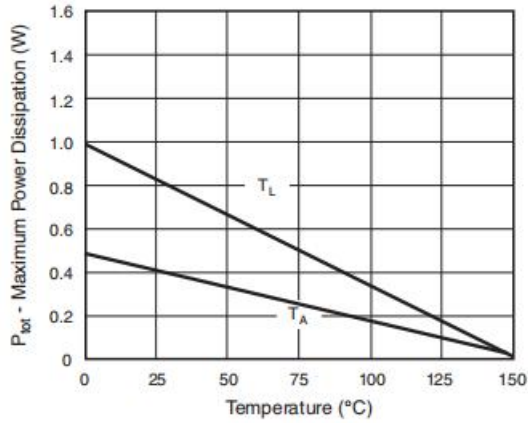

Figure 1: Power Derating Curve

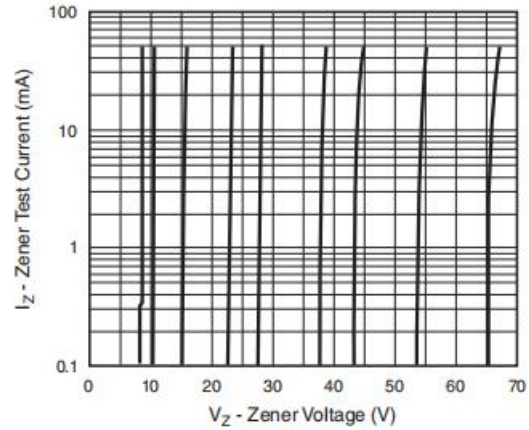

Figure 2: Zener Breakdown Characteristics

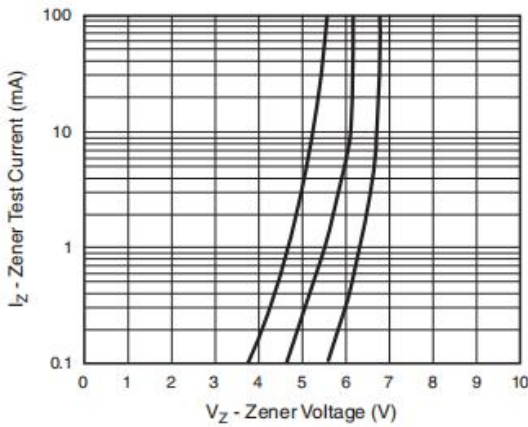

Figure 3: Zener Breakdown Characteristics

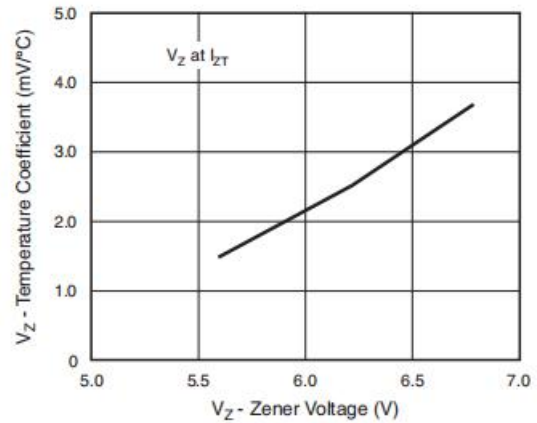

Figure 4: Temperature Coefficient

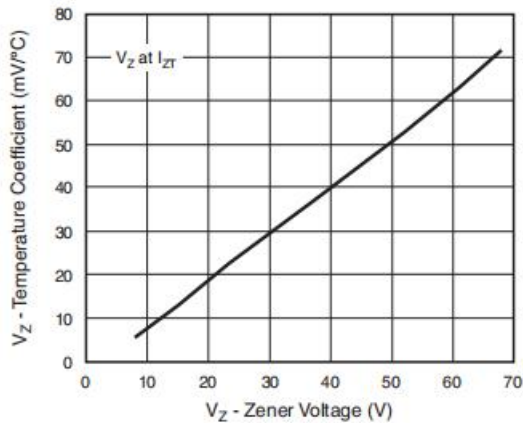

Figure 5: Temperature Coefficient

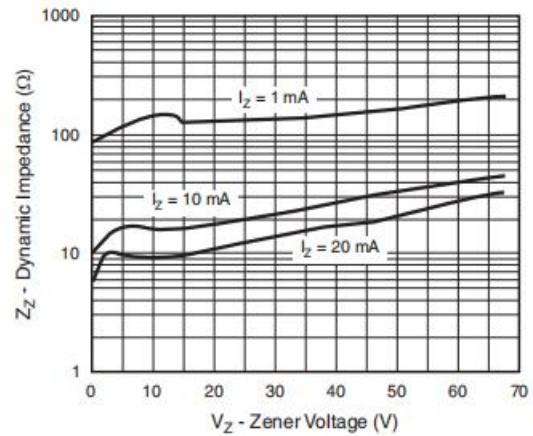
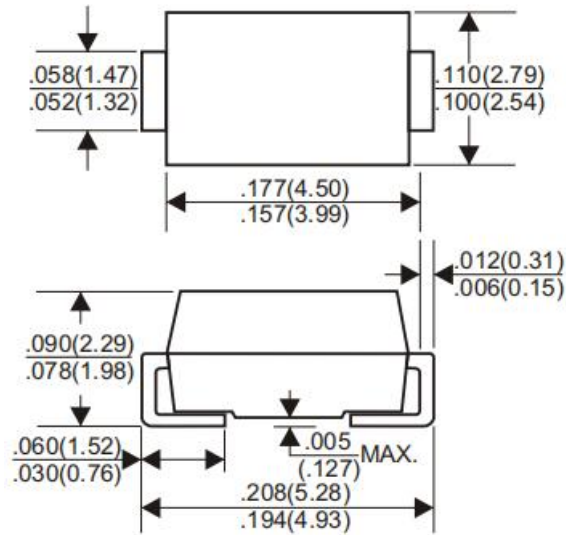

Figure 6: Zener Impedance

■Dimension 外形封装尺寸

DO-214AC(SMA)



Dimensions in inches and (millimeters)

X-ON Electronics

Largest Supplier of Electrical and Electronic Components

Click to view similar products for [Zener Diodes](#) category:

Click to view products by [FOSAN](#) manufacturer:

Other Similar products are found below :

[RKZ13B2KG#P1](#) [DL5234B](#) [1N4682](#) [1N4693](#) [1N4732A](#) [1N4736A](#) [1N4750A](#) [1N4759ARL](#) [1N5241B](#) [1N5365B](#) [1N5369B](#) [1N747A](#)
[1N964B](#) [1N966B](#) [1N968B](#) [1N972B](#) [JANS1N4974US](#) [1N4692](#) [1N4702](#) [1N4704](#) [1N4711](#) [1N4714](#) [1N4745ARL](#) [1N4752ARL](#) [1N4760ARL](#)
[1N5221B](#) [1N5242BTR](#) [1N5350B](#) [1N5352B](#) [1N961BRR1](#) [1N964BRL](#) [RKZ5.1BKU#P6](#) [3SMAJ5946B-TP](#) [3SMAJ5950B-TP](#)
[MMSZ5230BQ-13-F](#) [MMSZ5232BQ-13-F](#) [BZX84C7V5](#) [3SMAJ5945B-TP](#) [3SMAJ5947B-TP](#) [3SMBJ5941B-TP](#) [DZ2S240M0L](#) [SMAZ27-](#)
[TP](#) [ZMM5224B-7](#) [RD16UM-T1-A](#) [RD39S-T1-A](#) [RD10S-T1-A](#) [CDZT2R5.6B](#) [1N4762A G](#) [Z1SMA18](#) [JANTX1N4553B](#)