



安徽富信半导体科技有限公司

ANHUI FOSAN SEMICONDUCTOR TECHNOLOGY CO., LTD.

BZT52C2V4-BZT52C43

SOD-123 Surface Mounted Zener Diode 表面贴装稳压二极管



SOD-123

■ Absolute Maximum Ratings 最大额定值

Characteristic 特性参数	Symbol 符号	Rat 额定值	Unit 单位
Power dissipation 耗散功率	P_D ($T_a=25^\circ\text{C}$)	500	mW
Thermal Resistance Junction-Ambient 热阻	$R_{\theta JA}$	250	$^\circ\text{C}/\text{W}$
Forward Voltage 正向电压	V_F (@ $I_F=10\text{mA}$)	0.9	V
Reverse Voltage 反向电压	V_Z	2.4-43	V
Junction and Storage Temperature 结温和储藏温度	T_J, T_{stg}	150 $^\circ\text{C}$, -65to+150 $^\circ\text{C}$	

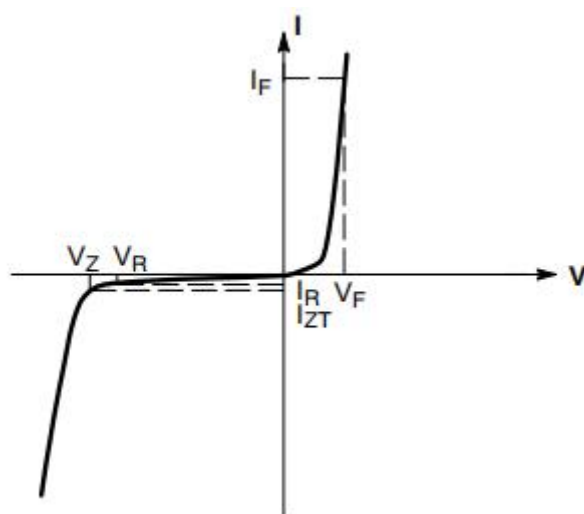



安徽富信半导体科技有限公司

ANHUI FOSAN SEMICONDUCTOR TECHNOLOGY CO., LTD.

BZT52C2V4-BZT52C43

■ Electrical Characteristics 电特性

($T_A=25^{\circ}\text{C}$ unless otherwise noted 如无特殊说明, 温度为 25°C)

Type	$V_Z(\text{V})$		DIFFERENTIAL RESISTANCE $r_{\text{dif}}(\Omega)$				TEMP. COEFF. $S_z(\text{mV/K})$			$I_R(\mu\text{A})$		Marking
	@ $I_{ZT}=5\text{mA}$		@ $I_{ZK}=1\text{mA}$		@ $I_{ZT}=5\text{mA}$		@ $I_{ZT}=5\text{mA}$			@ $V_R(\text{V})$		
	MIN.	MAX.	TYP.	MAX.	TYP.	MAX.	MIN.	TYP.	MAX.	I_R	@ V_R	
BZT52C2V4	2.2	2.6	325	600	80	100	-3.5	-2.1	0	50	1	WX
BZT52C2V7	2.5	2.9	325	600	80	100	-3.5	-2.1	0	20	1	W1
BZT52C3V0	2.8	3.2	325	600	80	95	-3.5	-2.1	0	10	1	W2
BZT52C3V3	3.1	3.5	350	600	85	95	-3.5	-2.4	0	5	1	W3
BZT52C3V6	3.4	3.8	375	600	85	90	-3.5	-2.4	0	5	1	W4
BZT52C3V9	3.7	4.1	400	600	85	90	-3.5	-2.5	0	3	1	W5
BZT52C4V3	4.0	4.6	400	600	85	90	-3.5	-2.5	0	3	1	W6
BZT52C4V7	4.4	5.0	410	600	80	90	-3.5	-2.5	0	3	2	W7
BZT52C5V1	4.8	5.4	425	500	50	80	-3.5	-1.4	0.2	2	2	W8
BZT52C5V6	5.2	6.0	400	480	40	60	-2.7	-0.8	1.2	1	2	W9
BZT52C6V2	5.8	6.6	80	400	15	40	-2.0	1.2	2.5	3	4	WA
BZT52C6V8	6.4	7.2	40	150	6	10	0.4	2.3	3.7	2	4	WB
BZT52C7V5	7.0	7.9	30	80	6	15	1.2	3.0	4.5	1	5	WC
BZT52C8V2	7.7	8.7	30	80	6	15	2.5	4.0	5.3	0.7	5	WD
BZT52C9V1	8.5	9.6	40	80	6	15	3.2	4.6	6.2	0.5	6	WE
BZT52C10	9.4	10.6	40	100	6	15	3.8	5.5	7.0	0.2	7	WF
BZT52C11	10.4	11.6	50	150	8	20	4.5	6.4	8.0	0.1	8	WG
BZT52C12	11.4	12.7	50	150	10	20	5.4	7.4	9.0	0.1	8	WH
BZT52C13	12.4	14.1	50	150	10	25	6.0	8.4	10.0	0.1	8	WI
BZT52C15	13.8	15.6	50	170	10	30	7.0	9.4	11.0	0.05	10.5	WJ
BZT52C16	15.3	17.1	50	200	10	30	9.2	11.4	13.0	0.05	11.2	WK
BZT52C18	16.8	19.1	50	200	10	40	10.4	12.4	14.0	0.05	12.6	WL
BZT52C20	18.8	21.2	50	225	10	45	12.4	14.4	16.0	0.05	14	WM
BZT52C22	20.8	23.3	60	225	15	55	14.4	16.4	18.0	0.05	15.4	WN
BZT52C24	22.8	25.6	60	250	20	55	16.4	18.4	20.0	0.05	16.8	WO
BZT52C27	25.1	28.9	65	300	25	80	21.4	23.4	25.3	0.05	18.9	WP
BZT52C30	28.0	32.0	70	300	30	80	24.4	26.6	29.4	0.05	21	WQ
BZT52C33	31.0	35.0	75	325	35	80	27.4	29.7	33.4	0.05	23.1	WR
BZT52C36	34.0	38.0	80	350	35	90	30.4	33.0	37.4	0.05	25.2	WS
BZT52C39	37.0	41.0	80	350	40	130	33.4	36.4	41.2	0.05	27.3	WT
BZT52C43	40.0	46.0	85	375	45	150	37.6	41.2	46.6	0.05	30.1	WU



Typical Characteristic Curve 典型特性曲线

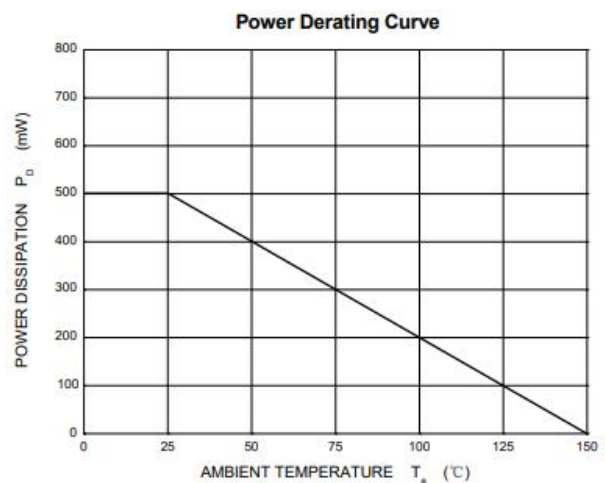
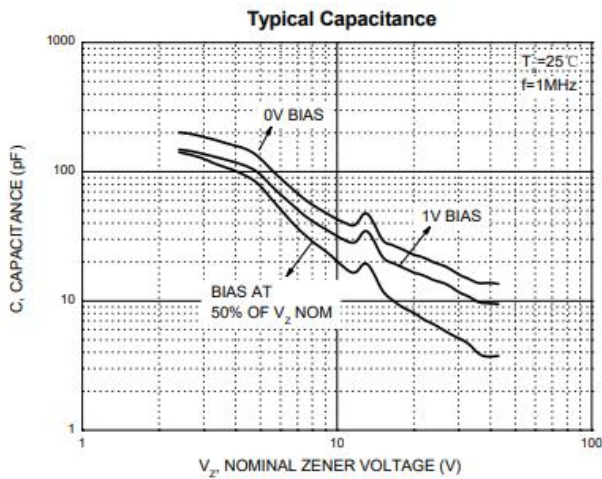
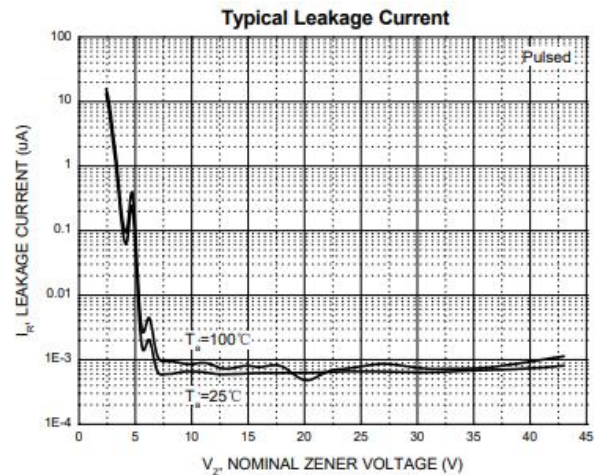
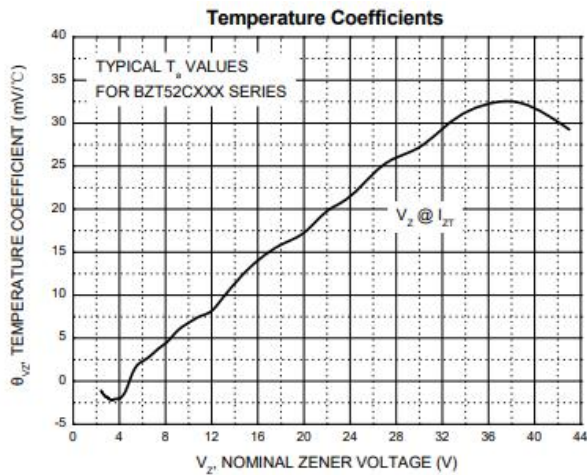
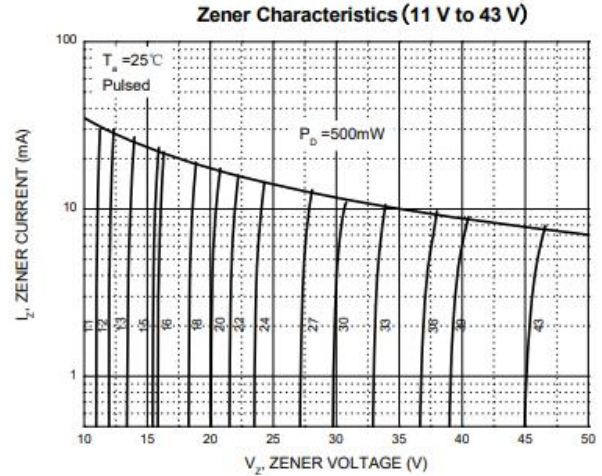
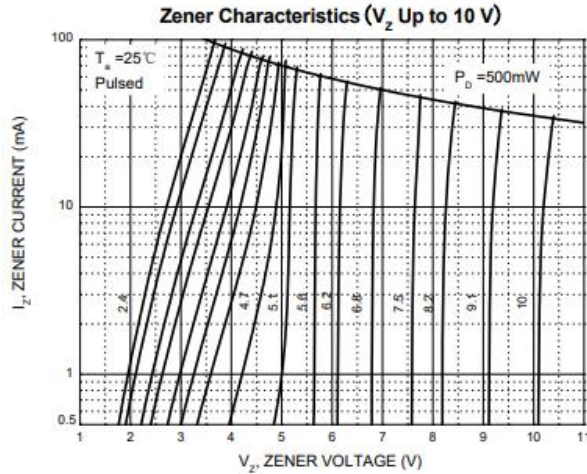

■Dimension 外形封装尺寸

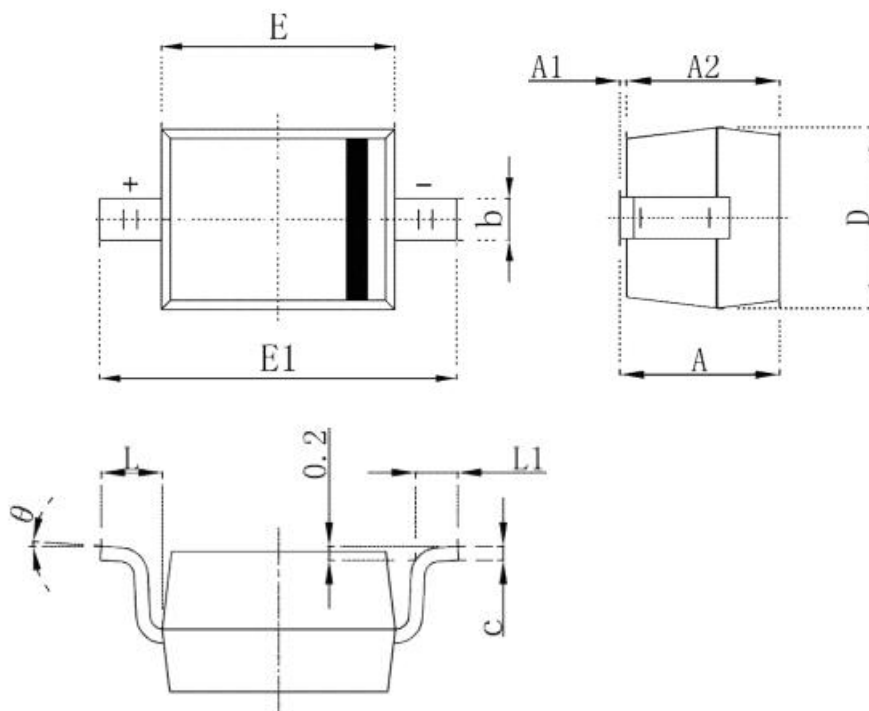

Symbol	Dimensions In Millimeters		Dimensions In Inches	
	Min.	Max.	Min.	Max.
A	1.050	1.250	0.041	0.049
A1	0.000	0.100	0.000	0.004
A2	1.050	1.150	0.041	0.045
b	0.450	0.650	0.018	0.026
c	0.080	0.150	0.003	0.006
D	1.500	1.700	0.059	0.067
E	2.600	2.800	0.102	0.110
E1	3.550	3.850	0.140	0.152
L	0.500REF		0.020 REF	
L1	0.250	0.450	0.010	0.018
θ	0°	8°	0°	8°

X-ON Electronics

Largest Supplier of Electrical and Electronic Components

Click to view similar products for [Zener Diodes](#) category:

Click to view products by [FOSAN](#) manufacturer:

Other Similar products are found below :

[RKZ13B2KG#P1](#) [DL5234B](#) [EDZTE6113B](#) [1N4682](#) [1N4691](#) [1N4693](#) [1N4732A](#) [1N4736A](#) [1N4750A](#) [1N4759ARL](#) [1N5241B](#) [1N5365B](#)
[1N5369B](#) [1N747A](#) [1N959B](#) [1N964B](#) [1N966B](#) [1N968B](#) [1N972B](#) [NTE5121A](#) [NTE5147A](#) [NTE5152A](#) [NTE5155A](#) [NTE5164A](#)
[JANS1N4974US](#) [JANTX1N5907](#) [1N4692](#) [1N4700](#) [1N4702](#) [1N4704](#) [1N4711](#) [1N4714](#) [1N4737A](#) [1N4745ARL](#) [1N4752A](#) [1N4752ARL](#)
[1N4760ARL](#) [1N5221B](#) [1N5231B-TR](#) [1N5236B](#) [1N5241BTR](#) [1N5242BTR](#) [1N5350B](#) [1N5352B](#) [1N961BRR1](#) [1N964BRL](#) [RKZ5.1BKU#P6](#)
[3SMAJ5946B-TP](#) [3SMAJ5950B-TP](#) [3SMBJ5925B-TP](#)