



## SOP-8 60V Dual N Channel Enhancement 双 N 沟道增强型 MOS Field Effect Transistor 场效应管

### ■ Features 特点

Low on-resistance 低导通电阻  
 $R_{DS(ON)}=30m\Omega(\text{Type})@V_{GS}=10V$   
 $R_{DS(ON)}=37m\Omega(\text{Type})@V_{GS}=4.5V$

### ■ Applications 应用

DC/DC Converter 升压转换  
 Powered Management 电源管理  
 LCD Display Converter 液晶屏背光驱动  
 Load Switch 负载开关  
 Portable Equipment 桌面设备

### ■ Internal Schematic Diagram 内部结构

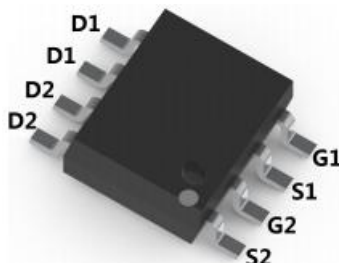
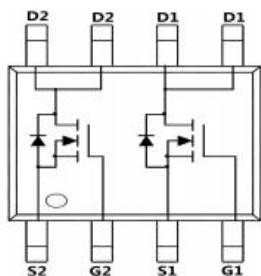

### ■ Absolute Maximum Ratings 最大额定值

Characteristic 特性参数	Symbol 符号	Rat 额定值	Unit 单位
Drain-Source Voltage 漏极-源极电压	$BV_{DSS}$	60	V
Gate- Source Voltage 栅极-源极电压	$V_{GS}$	$\pm 20$	V
Drain Current (continuous)漏极电流-连续	$I_D$ (at $T_A = 25^\circ\text{C}$ )	5	A
Drain Current (pulsed)漏极电流-脉冲	$I_{DM}$	40	A
Total Device Dissipation 总耗散功率	$P_D(\text{at } T_A = 25^\circ\text{C})$	2000	mW
Thermal Resistance Junction-Ambient 热阻	$R_{\theta JA}$	62.5	$^\circ\text{C}/\text{W}$
Junction/Storage Temperature 结温/储存温度	$T_J, T_{stg}$	-55~150	$^\circ\text{C}$



## ■ Electrical Characteristics 电特性

( $T_A=25^{\circ}\text{C}$  unless otherwise noted 如无特殊说明, 温度为  $25^{\circ}\text{C}$ )

Characteristic 特性参数	Symbol 符号	Min 最小值	Typ 典型值	Max 最大值	Unit 单位
Drain-Source Breakdown Voltage 漏极-源极击穿电压( $I_D=250\mu\text{A}, V_{GS}=0\text{V}$ )	$BV_{DSS}$	60	—	—	V
Gate Threshold Voltage 栅极开启电压( $I_D=250\mu\text{A}, V_{GS}=V_{DS}$ )	$V_{GS(th)}$	1	1.8	3	V
Zero Gate Voltage Drain Current 零栅压漏极电流( $V_{GS}=0\text{V}, V_{DS}=48\text{V}$ )	$I_{DSS}$	—	—	1	$\mu\text{A}$
Gate Body Leakage 栅极漏电流( $V_{GS}=\pm 20\text{V}, V_{DS}=0\text{V}$ )	$I_{GSS}$	—	—	$\pm 100$	nA
Static Drain-Source On-State Resistance 静态漏源导通电阻( $I_D=5\text{A}, V_{GS}=10\text{V}$ ) ( $I_D=3\text{A}, V_{GS}=4.5\text{V}$ )	$R_{DS(ON)}$	—	30 37	45 55	$\text{m}\Omega$
Diode Forward Voltage Drop 内附二极管正向压降( $I_{SD}=1\text{A}, V_{GS}=0\text{V}$ )	$V_{SD}$	—	0.8	1.3	V
Input Capacitance 输入电容 ( $V_{GS}=0\text{V}, V_{DS}=25\text{V}, f=1\text{MHz}$ )	$C_{ISS}$	—	520	—	pF
Common Source Output Capacitance 共源输出电容( $V_{GS}=0\text{V}, V_{DS}=25\text{V}, f=1\text{MHz}$ )	$C_{OSS}$	—	105	—	pF
Reverse Transfer Capacitance 反馈电容 ( $V_{GS}=0\text{V}, V_{DS}=25\text{V}, f=1\text{MHz}$ )	$C_{RSS}$	—	60	—	pF
Total Gate Charge 栅极电荷密度 ( $V_{DS}=30\text{V}, I_D=5\text{A}, V_{GS}=10\text{V}$ )	$Q_g$	—	16	—	nC
Gate Source Charge 栅源电荷密度 ( $V_{DS}=30\text{V}, I_D=5\text{A}, V_{GS}=10\text{V}$ )	$Q_{gs}$	—	2	—	nC
Gate Drain Charge 栅漏电荷密度 ( $V_{DS}=30\text{V}, I_D=5\text{A}, V_{GS}=10\text{V}$ )	$Q_{gd}$	—	5	—	nC
Turn-ON Delay Time 开启延迟时间 ( $V_{DS}=30\text{V}, I_D=1\text{A}, R_{GEN}=6\Omega, V_{GS}=10\text{V}$ )	$t_{d(on)}$	—	8	—	ns
Turn-ON Rise Time 开启上升时间 ( $V_{DS}=30\text{V}, I_D=1\text{A}, R_{GEN}=6\Omega, V_{GS}=10\text{V}$ )	$t_r$	—	6	—	ns
Turn-OFF Delay Time 关断延迟时间 ( $V_{DS}=30\text{V}, I_D=1\text{A}, R_{GEN}=6\Omega, V_{GS}=10\text{V}$ )	$t_{d(off)}$	—	25	—	ns
Turn-OFF Fall Time 关断下降时间 ( $V_{DS}=30\text{V}, I_D=1\text{A}, R_{GEN}=6\Omega, V_{GS}=10\text{V}$ )	$t_f$	—	5	—	ns

## Typical Characteristic Curve 典型特性曲线

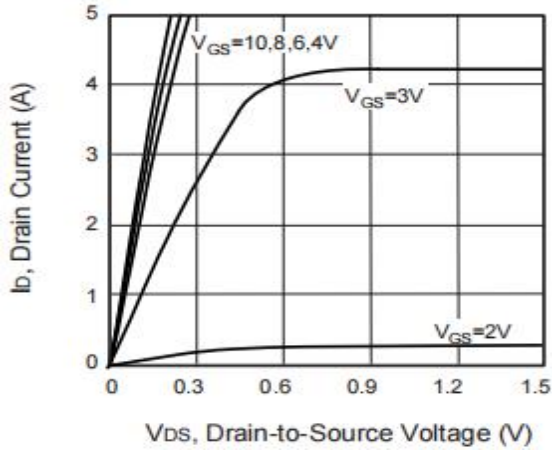

Figure 1: Output Characteristics

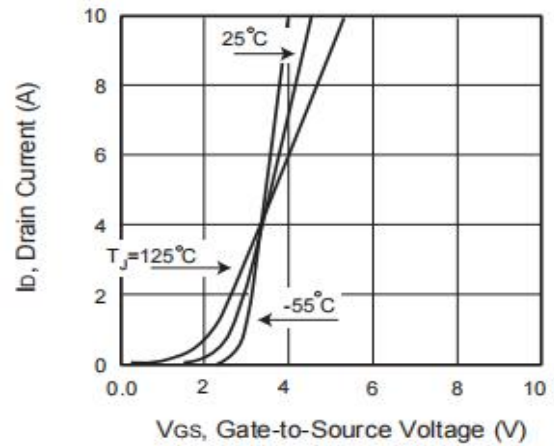

Figure 2: Transfer Characteristics

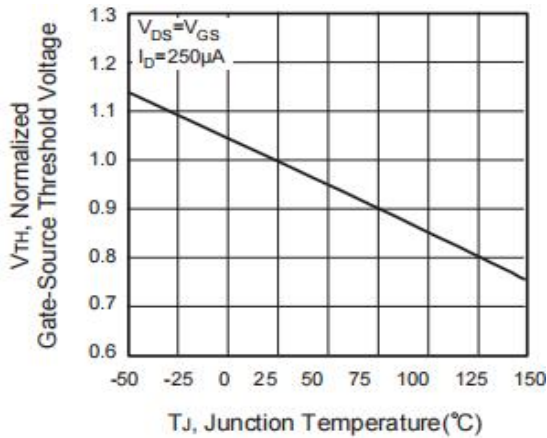

Figure 3: Threshold Voltage vs. Temperature

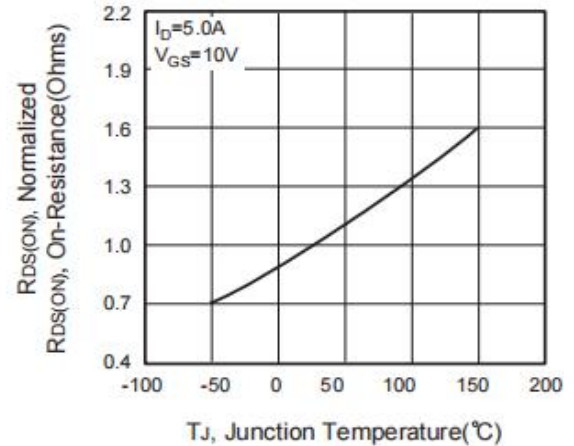

Figure 4: On-Resistance vs. Temperature

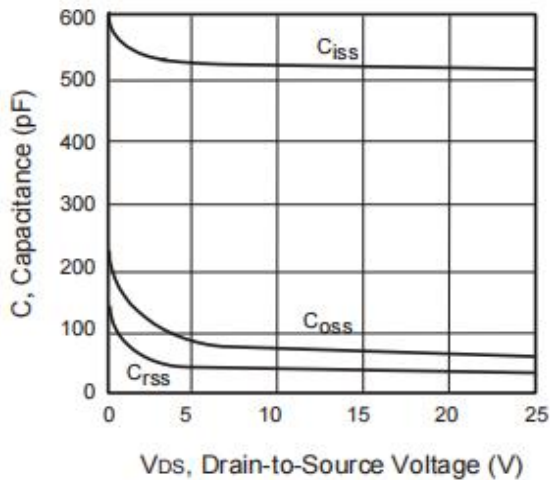

Figure 5: Capacitance Characteristics

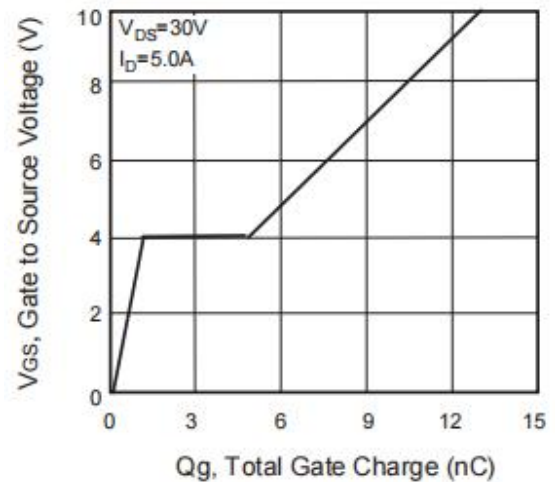

Figure 6: Gate-Charge Characteristics

## ■ Typical Characteristic Curve 典型特性曲线

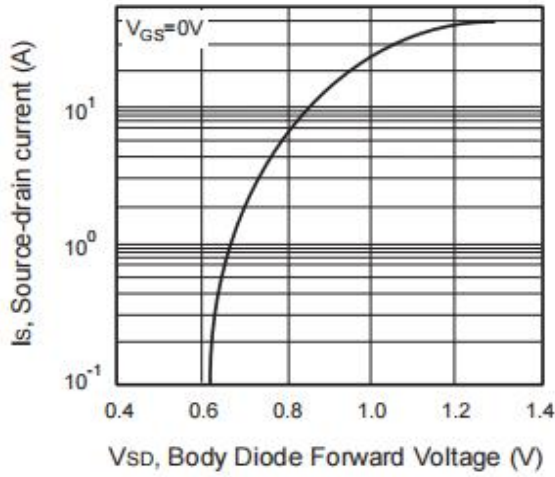

Figure 7: Diode Characteristics

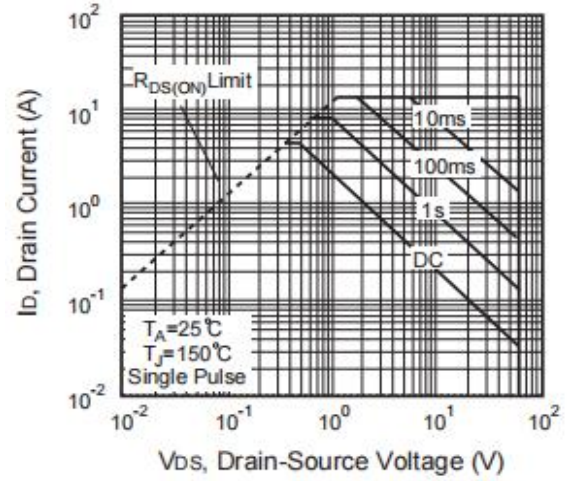

Figure 8: Safe Operating Area

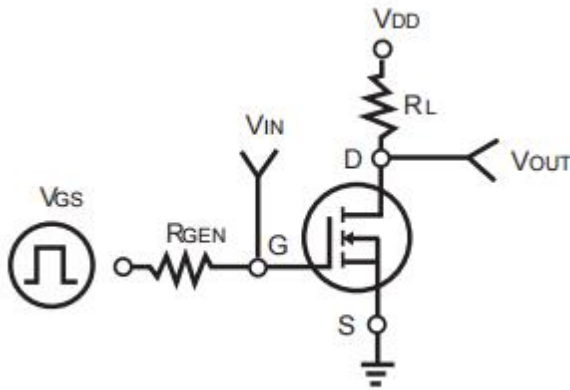

Figure 9: Switching Test Circuit

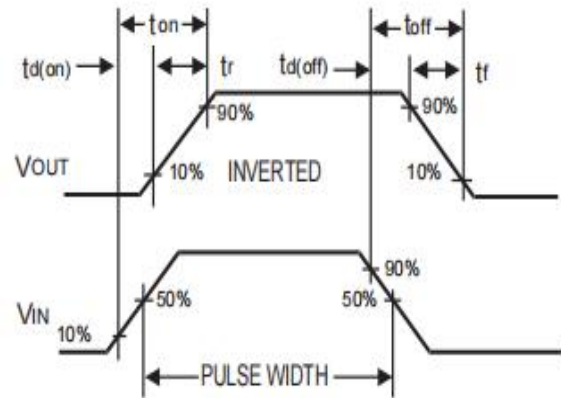

Figure 10: Switching Waveform

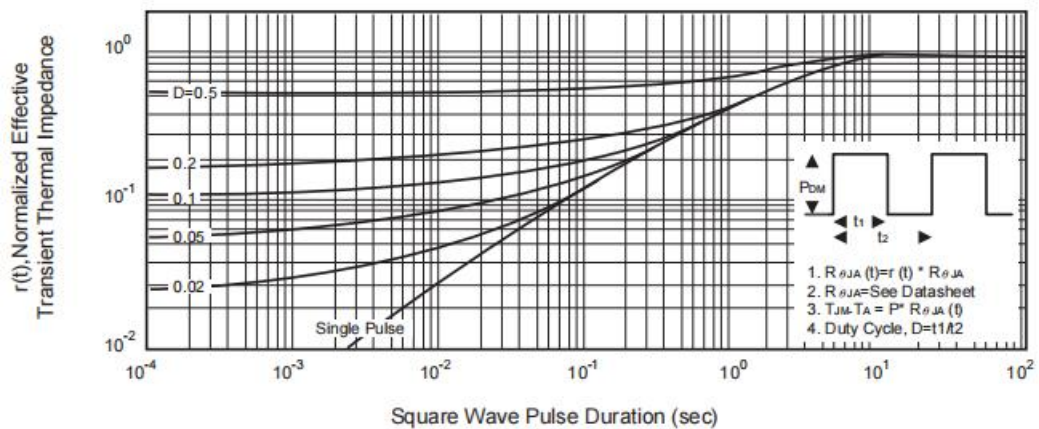
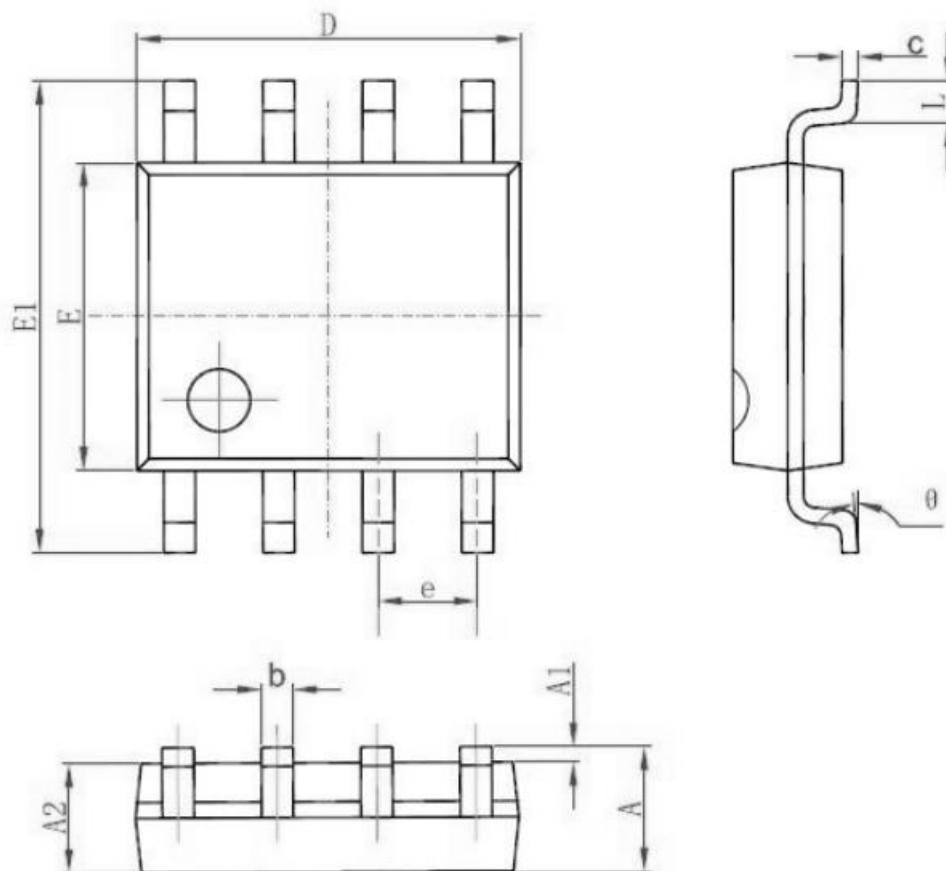

Figure 11: Transient Thermal Response Curve

## ■ Dimension 外形封装尺寸



Symbol	Dimensions In Millimeters		Dimensions In Inches	
	Min	Max	Min	Max
A	1.350	1.750	0.053	0.069
A1	0.100	0.250	0.004	0.010
A2	1.350	1.550	0.053	0.061
b	0.330	0.510	0.013	0.020
c	0.170	0.250	0.006	0.010
D	4.700	5.100	0.185	0.200
E	3.800	4.000	0.150	0.157
E1	5.800	6.200	0.228	0.244
e	1.270 (BSC)		0.050 (BSC)	
L	0.400	1.270	0.016	0.050
θ	0°	8°	0°	8°

## X-ON Electronics

Largest Supplier of Electrical and Electronic Components

*Click to view similar products for [MOSFET](#) category:*

*Click to view products by [FOSAN](#) manufacturer:*

Other Similar products are found below :

[IRFD120](#) [JANTX2N5237](#) [2SK2267\(Q\)](#) [BUK455-60A/B](#) [TK100A10N1,S4X\(S](#) [MIC4420CM-TR](#) [VN1206L](#) [NDP4060](#) [SI4482DY](#)  
[IRS2092STRPBF-EL](#) [IPS70R2K0CEAKMA1](#) [TK31J60W5,S1VQ\(O](#) [TK31J60W,S1VQ\(O](#) [TK16J60W,S1VQ\(O](#) [2SK2614\(TE16L1,Q\)](#)  
[DMN1017UCP3-7](#) [EFC2J004NUZTDG](#) [P85W28HP2F-7071](#) [DMN1053UCP4-7](#) [NTE2384](#) [DMC2700UDMQ-7](#) [DMN2080UCB4-7](#)  
[DMN61D9UWQ-13](#) [US6M2GTR](#) [DMN31D5UDJ-7](#) [DMP22D4UFO-7B](#) [IPS60R3K4CEAKMA1](#) [DMN1006UCA6-7](#) [DMN16M9UCA6-7](#)  
[STF5N65M6](#) [IRF40H233XTMA1](#) [STU5N65M6](#) [DMN6022SSD-13](#) [DMN13M9UCA6-7](#) [DMTH10H4M6SPS-13](#) [IPS60R360PFD7SAKMA1](#)  
[DMN2990UFB-7B](#) [SSM3K35CT,L3F](#) [IPLK60R1K0PFD7ATMA1](#) [2N7002W-G](#) [MCAC30N06Y-TP](#) [IPWS65R035CFD7AXKSA1](#)  
[MCQ7328-TP](#) [SSM3J143TU,LXHF](#) [DMN12M3UCA6-7](#) [PJMF280N65E1\\_T0\\_00201](#) [PJMF380N65E1\\_T0\\_00201](#)  
[PJMF280N60E1\\_T0\\_00201](#) [PJMF600N65E1\\_T0\\_00201](#) [PJMF900N65E1\\_T0\\_00201](#)