

- ALL DIMENSIONS ARE IN MILLIMETERS.
- DIMENSIONING AND TOLERANCING PER ASME Y14.5M-1994.

3. MATERIAL:

HOUSING: THERMOPLASTIC,UL94V-0,COLOR BLACK.  
 CONTACT: COPPER ALLOY  
 SOLDER BALL: LEAD FREE 0.60MM DIAMETER  
 PICKUP CAP: THERMOPLASTIC,UL94V-0,COLOR BLACK.  
 ALIGNMENT KEY: THERMOPLASTIC,UL94V-0  
 PLATING: 15u" Min or 30u" Min. Au PLATED ON CONTACT AREA  
 50u" Min. Ni PLATED OVER WHOLE CONTACT

4. CONTACT LOADED HEIGHT: 2.70±0.20 MM AFTER REFLOW PROCESS.

- DATE CODE POSITION.
- FOXCONN LOGO POSITION.
- "LGA3647-X" NAME POSITION.WHERE "X" DENOTES THE SPECIFIC SOCKET KEYING.
- HARMFUL MATERIAL CONTROL PLEASE FOLLOW DOC. NO. "EPI12".
- THE CONCENTRATIONS OF Br AND Cl CAN SATISFY THE REQUIREMENT OF HALOGEN-FREE IN DOCUMENT "EPI12".
- PLEASE CONTACT FOXCONN SALES REPRESENTATIVE TO VERIFY PRODUCT DETAIL AND AVAILABILITY.

REV.	ECN. NO.	APPD.
A	BC-15-0052650	S. Szu
B	BC-16-0029673	Nick Lin
C	BC-16-0053386	Nick Lin
D	BC-17-0021125	Nick Lin
E	BC-18-0005286	Nick Lin

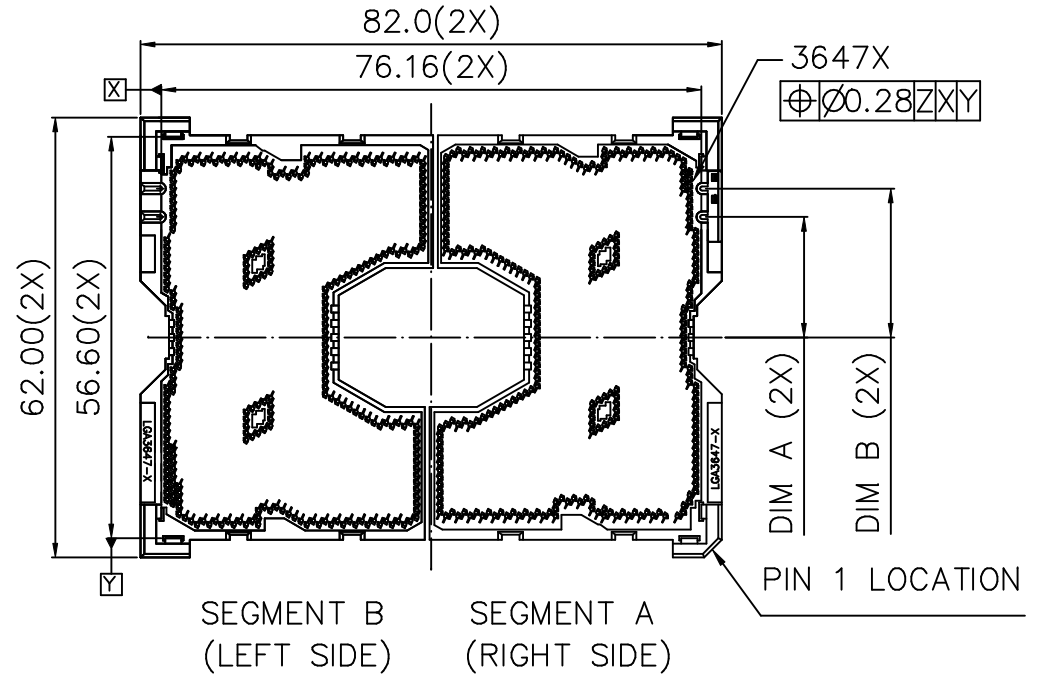
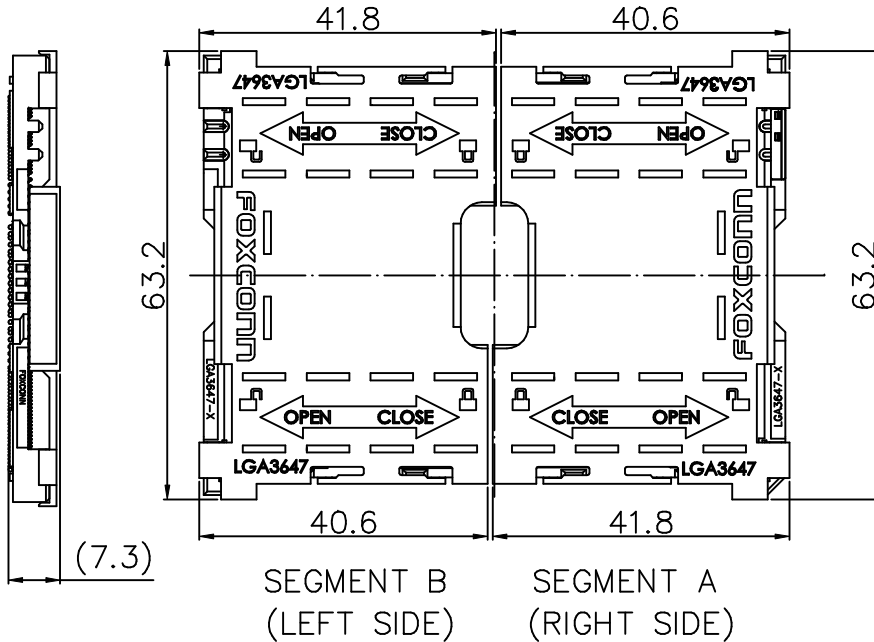

CONFIGURATION FOR SOCKET P1

SOCKET	SEG. PART NUMBER	REMARK	KEY COLOR	DIM A	DIM B	KEY TYPE
SOCKET P3	PE36473-31NK2-1H	P3 SEGMENT B (30u"Au)	BLACK	20	21	TYPE2
	PE36473-31NK1-1H	P3 SEGMENT A (30u"Au)	PURPLE			
SOCKET P2	PE36473-21NK2-1H	P2 SEGMENT B (30u"Au)	BLACK	17	18	TYPE2
	PE36473-21NK1-1H	P2 SEGMENT A (30u"Au)	BLUE			
SOCKET P1	PE36473-11NK4-1H	P1 SEGMENT B (30u"Au)	BLACK	17	21	TYPE 1
	PE36473-11NK3-1H	P1 SEGMENT A (30u"Au)	WHITE			
	PE36477-11NK2-1H	P1 SEGMENT B (15u"Au)	BLACK			
	PE36477-11NK1-1H	P1 SEGMENT A (15u"Au)	WHITE			
SOCKET P0	PE36473-01NK4-1H	P0 SEGMENT B (30u"Au)	BLACK	16	NA	TYPE 1
	PE36473-01NK3-1H	P0 SEGMENT A (30u"Au)	YELLOW			
	PE36477-01NK2-1H	P0 SEGMENT B (15u"Au)	BLACK			
	PE36477-01NK1-1H	P0 SEGMENT A (15u"Au)	YELLOW			

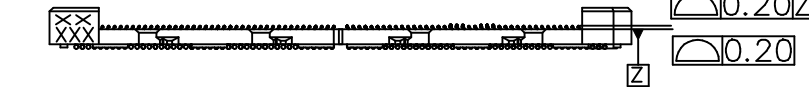

X.± 3	X.± 1*	UNITS mm	NAME(INTENDED USE)	FOXCONN INTERCONNECT TECHNOLOGY LIMITED.
.X± 0.25	.X±	MAT'L	LGA3647 SOCKET	
.XX± 0.10	.XX±		PART NO.(INTENDED USE)	CLASS: <input type="checkbox"/> CONFIDENTIAL <input type="checkbox"/> SECRET <input checked="" type="checkbox"/> GENERAL
.XXX±	.XXX±		FINISH	PE3647*-*****-1H
<small>THESE DRAWINGS AND SPECIFICATIONS ARE THE PROPERTY OF FOXCONN INTERCONNECT TECHNOLOGY LIMITED,AND SHALL NOT BE REPRODUCED, COPIED OR USED IN ANY MANNER WITHOUT THE PRIOR WRITTEN CONSENT OF FOXCONN INTERCONNECT TECHNOLOGY LIMITED.</small>			APPD: Nick Lin	TITLE: FOR LGA3647 SOCKET
			Q'TY	DWG NO.: 351-0000-1318
			CHKD: Mac Peng	SCALE SHEET REV.
			DRAW: Gohan Wu 01/24'18	1:1 1/6 E

REV.	ECN. NO.	APPD.

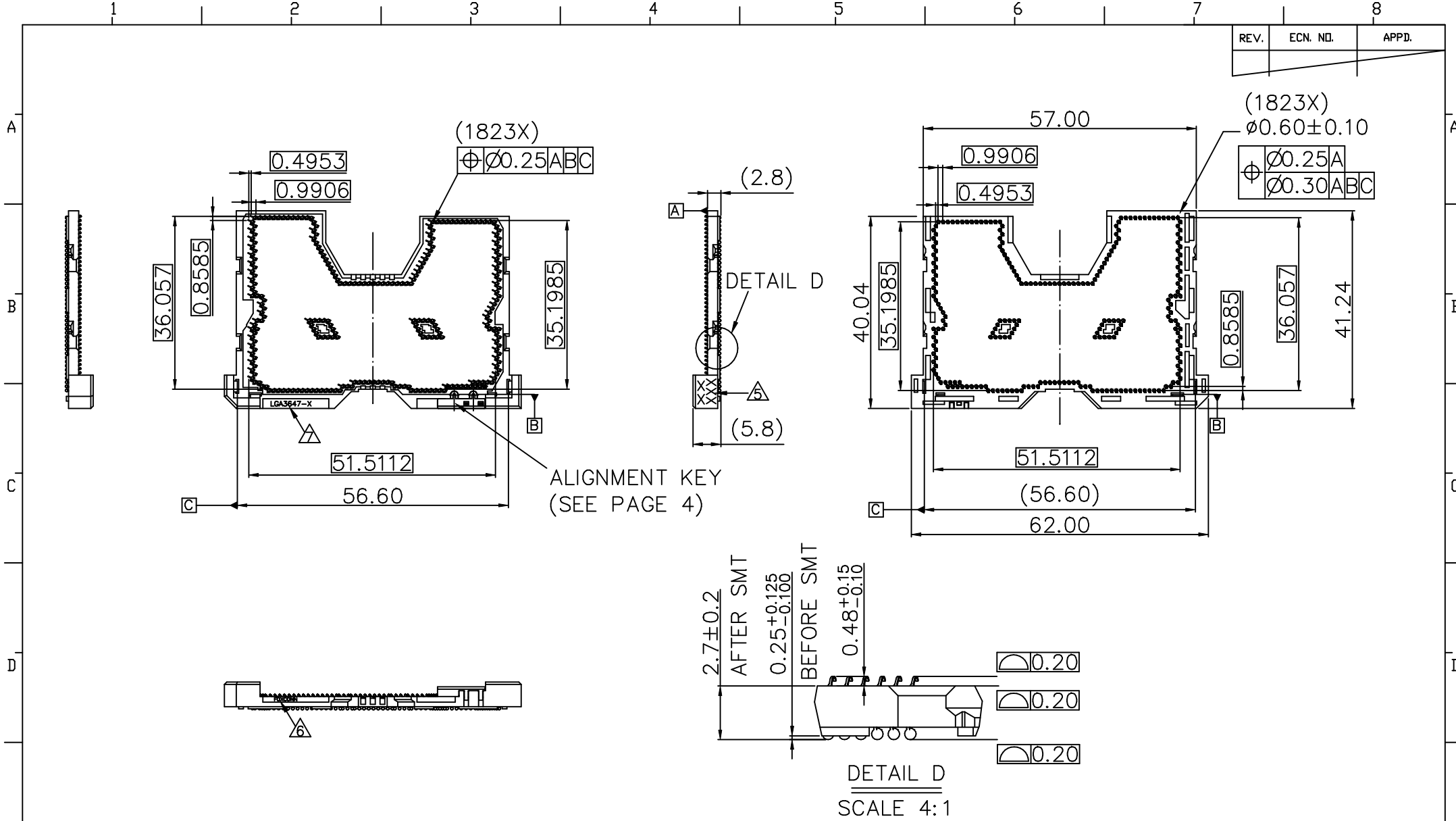

P3 SEGMENT A	PE36473-31NK1-1H	30u" Au
P2 SEGMENT A	PE36473-21NK1-1H	30u" Au
	PE36473-11NK3-1H	30u" Au
P1 SEGMENT A	PE36477-11NK1-1H	15u" Au
	PE36473-01NK3-1H	30u" Au
P0 SEGMENT A	PE36477-01NK1-1H	15u" Au
DESCRIPTION	PART NUMBER	CONTACT PLATING

X.± 3	X.± 1*	UNITS mm	NAME (INTENDED USE) LGA3647 SOCKET	<b>FOXCONN INTERCONNECT TECHNOLOGY LIMITED.</b>				
.X± 0.25	.X*±	MAT'L	PART NO. (INTENDED USE) PE3647*-*****-1H					
.XX± 0.10	.XX*±		APPD: Nick Lin	CLASS: <input type="checkbox"/> CONFIDENTIAL <input type="checkbox"/> SECRET <input checked="" type="checkbox"/> GENERAL				
.XXX±	.XXX*±		FINISH	CHKD: Mac Peng	CUSTOMER DRAWING			
<small>THESE DRAWINGS AND SPECIFICATIONS ARE THE PROPERTY OF FOXCONN INTERCONNECT TECHNOLOGY LIMITED, AND SHALL NOT BE REPRODUCED, COPIED OR USED IN ANY MANNER WITHOUT THE PRIOR WRITTEN CONSENT OF FOXCONN INTERCONNECT TECHNOLOGY LIMITED.</small>			Q'TY	DWG NO.: 351-0000-1318				
			DRAW: Gohan Wu 01/24'18		<table border="1"> <tr> <td>SCALE</td> <td>SHEET</td> <td>REV.</td> </tr> <tr> <td>1:1</td> <td>2/6</td> <td>E</td> </tr> </table>	SCALE	SHEET	REV.
SCALE	SHEET	REV.						
1:1	2/6	E						

REV.	ECN. NO.	APPD.

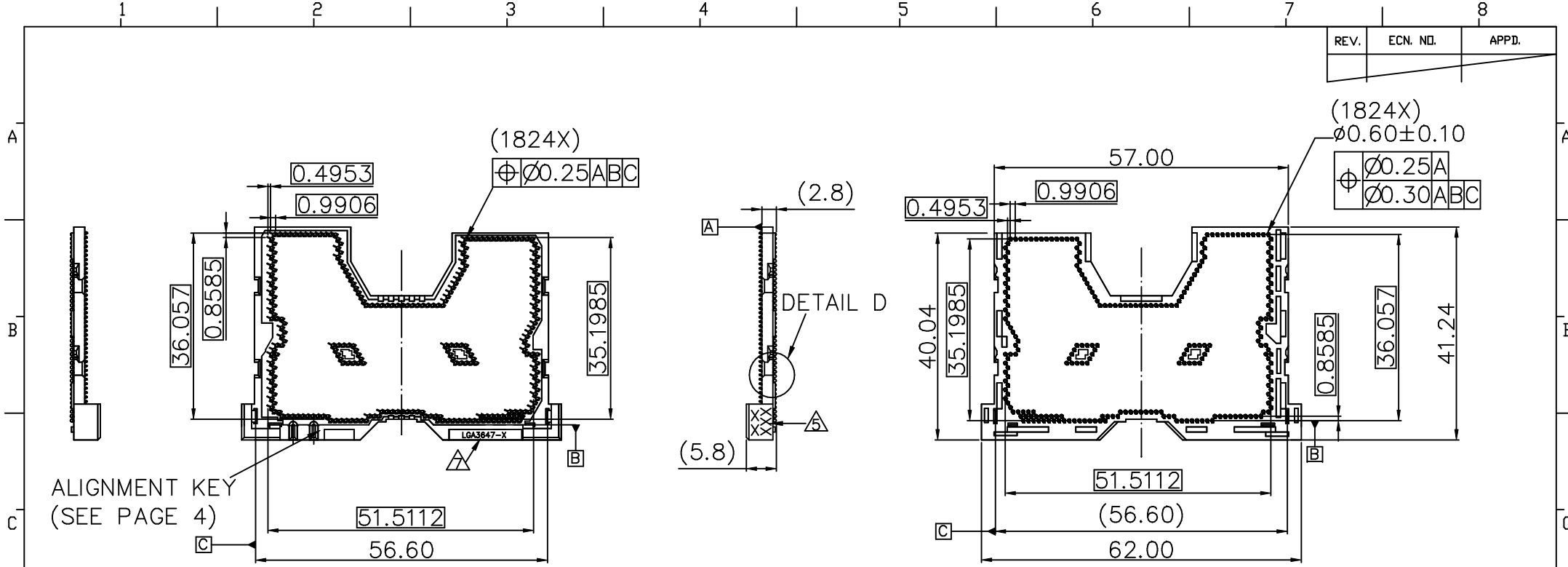

ALIGNMENT KEY  
(SEE PAGE 4)

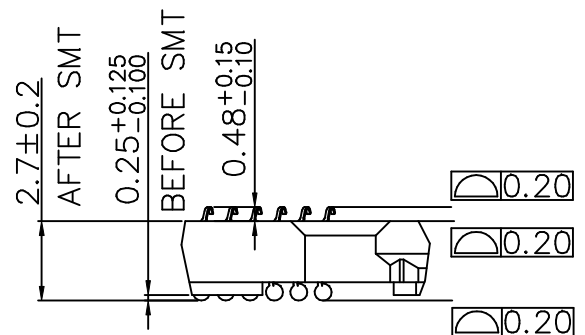
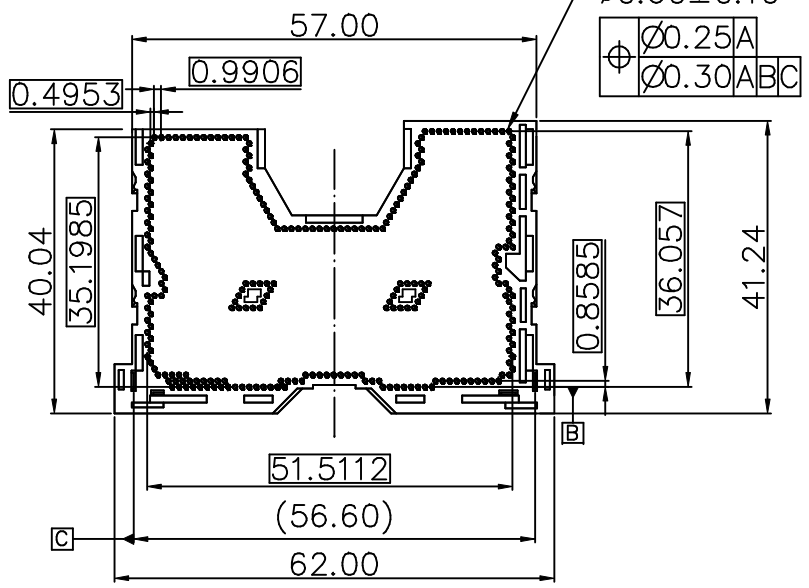
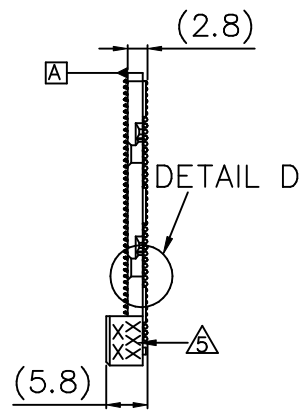

DETAIL D  
SCALE 4:1

DESCRIPTION	PART NUMBER	CONTACT PLATING
P3 SEGMENT B	PE36473-31NK2-1H	30u" Au
P2 SEGMENT B	PE36473-21NK2-1H	30u" Au
	PE36473-11NK4-1H	30u" Au
P1 SEGMENT B	PE36477-11NK2-1H	15u" Au
	PE36473-01NK4-1H	30u" Au
P0 SEGMENT B	PE36477-01NK2-1H	15u" Au

X.± 3	X.± 1'	UNITS mm	NAME (INTENDED USE) LGA3647 SOCKET	FOXCONN INTERCONNECT TECHNOLOGY LIMITED.						
.X± 0.25	.X'±	MAT'L	PART NO. (INTENDED USE) PE3647*-*****-1H							
.XX± 0.10	.XX'±		APPD: Nick Lin	CLASS: <input type="checkbox"/> CONFIDENTIAL <input type="checkbox"/> SECRET <input checked="" type="checkbox"/> GENERAL CUSTOMER DRAWING TITLE: FOR LGA3647 SOCKET						
.XXX±	.XXX'±		FINISH	CHKD: Mac Peng	DWG NO.: 351-0000-1318					
THESE DRAWINGS AND SPECIFICATIONS ARE THE PROPERTY OF FOXCONN INTERCONNECT TECHNOLOGY LIMITED, AND SHALL NOT BE REPRODUCED, COPIED OR USED IN ANY MANNER WITHOUT THE PRIOR WRITTEN CONSENT OF FOXCONN INTERCONNECT TECHNOLOGY LIMITED.			Q'TY	DRAW: Gohan Wu 01/24'18						
				<table border="1"> <tr> <td>SCALE</td> <td>SHEET</td> <td>REV.</td> </tr> <tr> <td>1:1</td> <td>3/6</td> <td>E</td> </tr> </table>	SCALE	SHEET	REV.	1:1	3/6	E
SCALE	SHEET	REV.								
1:1	3/6	E								

REV.	ECN. NO.	APPD.
------	----------	-------

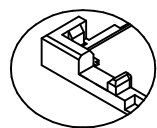

P0 KEY  
TYPE 1

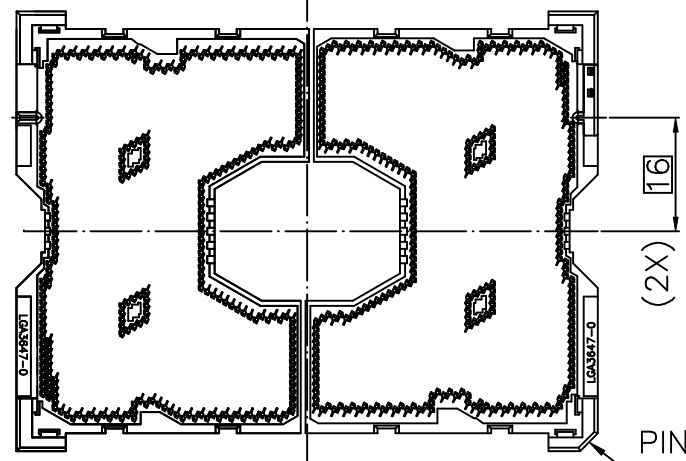

PIN 1 LOCATION

SOCKET P0

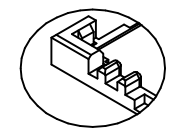

P1 KEY  
TYPE 1

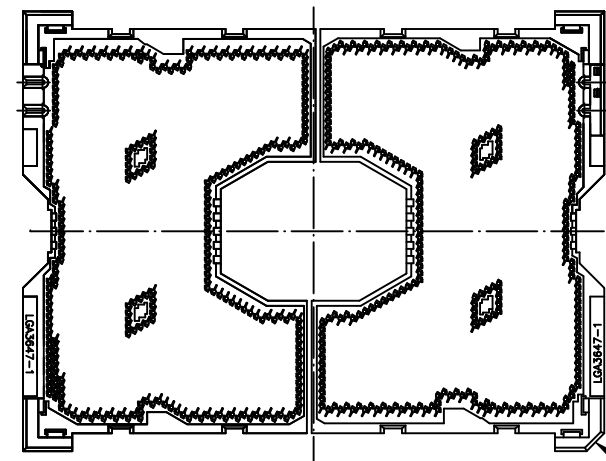

PIN 1 LOCATION

SOCKET P1

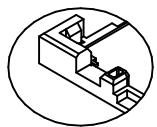

P2 KEY  
TYPE 2

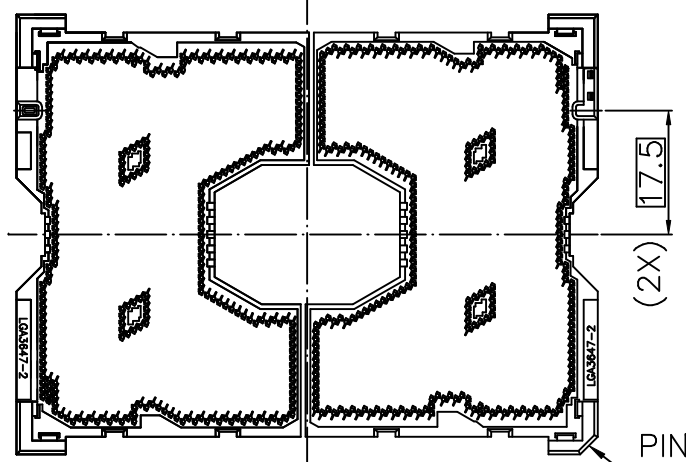

PIN 1 LOCATION

SOCKET P2

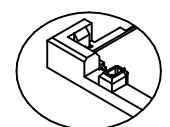

P3 KEY  
TYPE 2

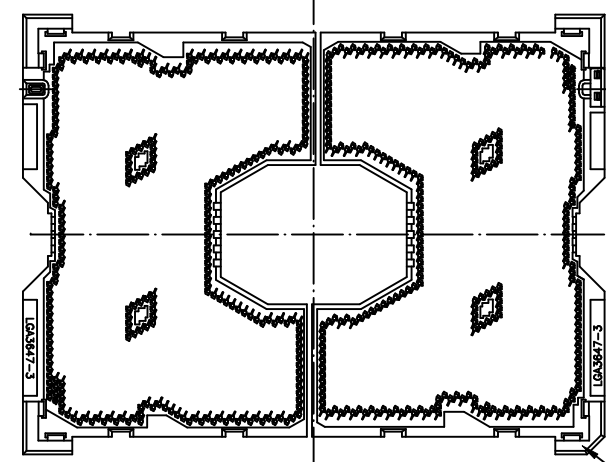

PIN 1 LOCATION

SOCKET P3



SOCKET P3	BLACK	PURPLE
SOCKET P2		BLUE
SOCKET P1		WHITE
SOCKET P0		YELLOW
DESCRIPTION	SEGMENT B(LEFT) KEY COLOR	SEGMENT A(RIGHT) KEY COLOR

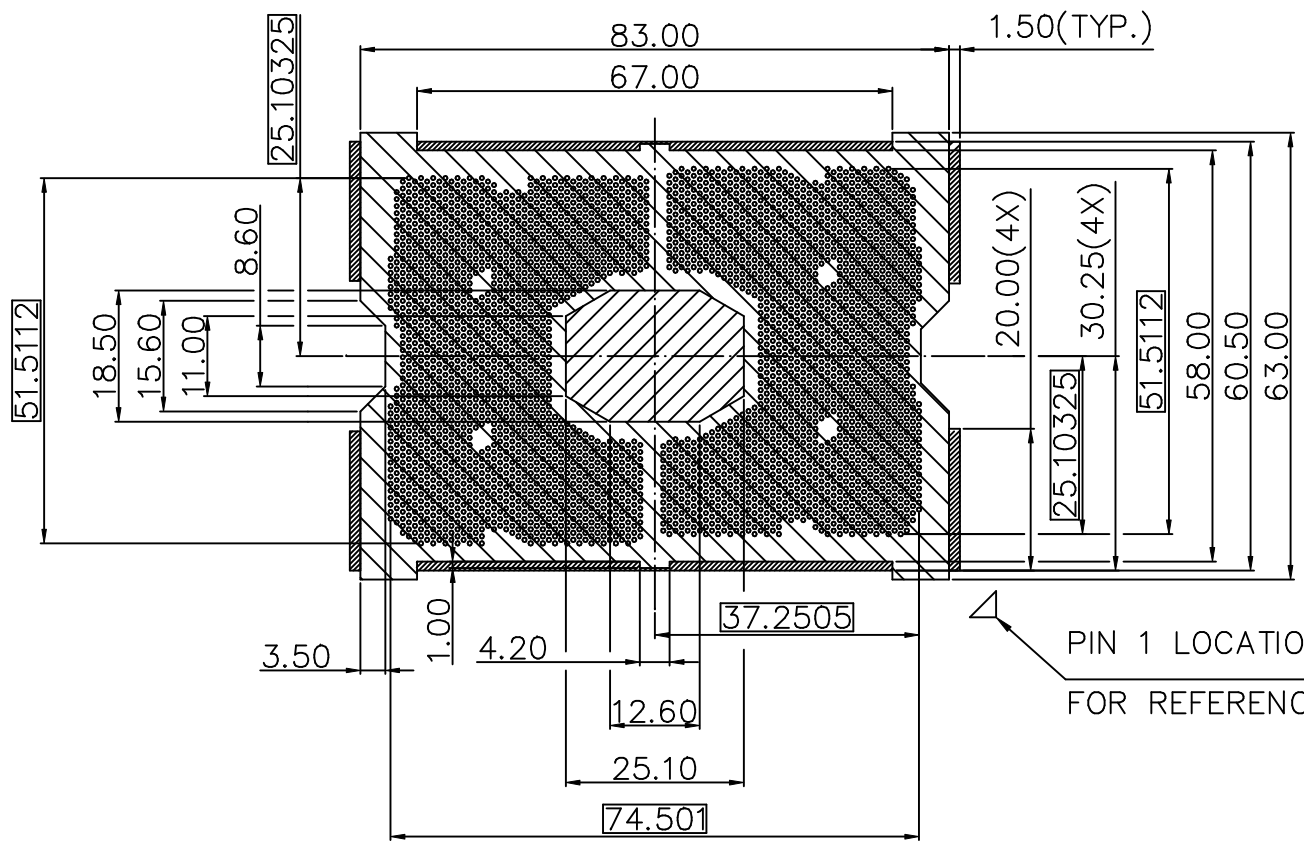

X.± 3	X.± 1*	UNITS mm	NAME(INTENDED USE) LGA3647 SOCKET	<b>FOXCONN INTERCONNECT TECHNOLOGY LIMITED.</b>						
.X± 0.25	.X*±	MAT'L	PART NO.(INTENDED USE) PE3647*-*****-1H							
.XX± 0.10	.XX*±	 FINISH	APPD: Nick Lin	CLASS: <input type="checkbox"/> CONFIDENTIAL <input type="checkbox"/> SECRET <input checked="" type="checkbox"/> GENERAL CUSTOMER DRAWING TITLE: FOR LGA3647 SOCKET						
.XXX±	.XXX*±		Q'TY	CHKD: Mac Peng	DWG NO.: 351-0000-1318					
<small>THESE DRAWINGS AND SPECIFICATIONS ARE THE PROPERTY OF FOXCONN INTERCONNECT TECHNOLOGY LIMITED, AND SHALL NOT BE REPRODUCED, COPIED OR USED IN ANY MANNER WITHOUT THE PRIOR WRITTEN CONSENT OF FOXCONN INTERCONNECT TECHNOLOGY LIMITED.</small>			DRAW: Gohan Wu 01/24'18	<table border="1"> <tr> <td>SCALE</td> <td>SHEET</td> <td>REV.</td> </tr> <tr> <td>1:1</td> <td>4/6</td> <td>E</td> </tr> </table>	SCALE	SHEET	REV.	1:1	4/6	E
SCALE	SHEET	REV.								
1:1	4/6	E								

REV.	ECN. NO.	APPD.



RECOMMENDED PAD ARRAY LAYOUT

-  **SOCKET P PLACEMENT ZONE**  
NO OTHER COMPONENT PLACEMENT ALLOWED.  
0.0 MM HEIGHT RESTRICTION.
-  **SOCKET CAVITY**  
1.222 MM HEIGHT RESTRICTION.
-  **SOCKET PICK & PLACE CAP SKIRT ZONE**  
0.0 MM HEIGHT RESTRICTION.

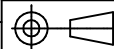
X.± 3	X.*± 1*	UNITS mm	NAME(INTENDED USE) LGA3647 SOCKET	 <b>FOXCONN INTERCONNECT TECHNOLOGY LIMITED.</b>			
.X± 0.25	.X*±	MAT'L	PART NO.(INTENDED USE) PE3647*-*****-1H				
.XX± 0.10	.XX*±	 FINISH	APPD: Nick Lin	CLASS: <input type="checkbox"/> CONFIDENTIAL <input type="checkbox"/> SECRET <input checked="" type="checkbox"/> GENERAL			
.XXX±	.XXX*±		Q'TY	CHKD: Mac Peng	CUSTOMER DRAWING TITLE: FOR LGA3647 SOCKET		
<small>THESE DRAWINGS AND SPECIFICATIONS ARE THE PROPERTY OF FOXCONN INTERCONNECT TECHNOLOGY LIMITED, AND SHALL NOT BE REPRODUCED, COPIED OR USED IN ANY MANNER WITHOUT THE PRIOR WRITTEN CONSENT OF FOXCONN INTERCONNECT TECHNOLOGY LIMITED.</small>			DRAW: Gohan Wu 01/24'18	DWG NO.: 351-0000-1318			
			 <table border="1"> <tr> <td>SCALE</td> <td>SHEET</td> <td>REV.</td> </tr> <tr> <td>1:1</td> <td>5/6</td> <td>E</td> </tr> </table>		SCALE	SHEET	REV.
SCALE	SHEET	REV.					
1:1	5/6	E					

REV.	ECN. NO.	APPD.

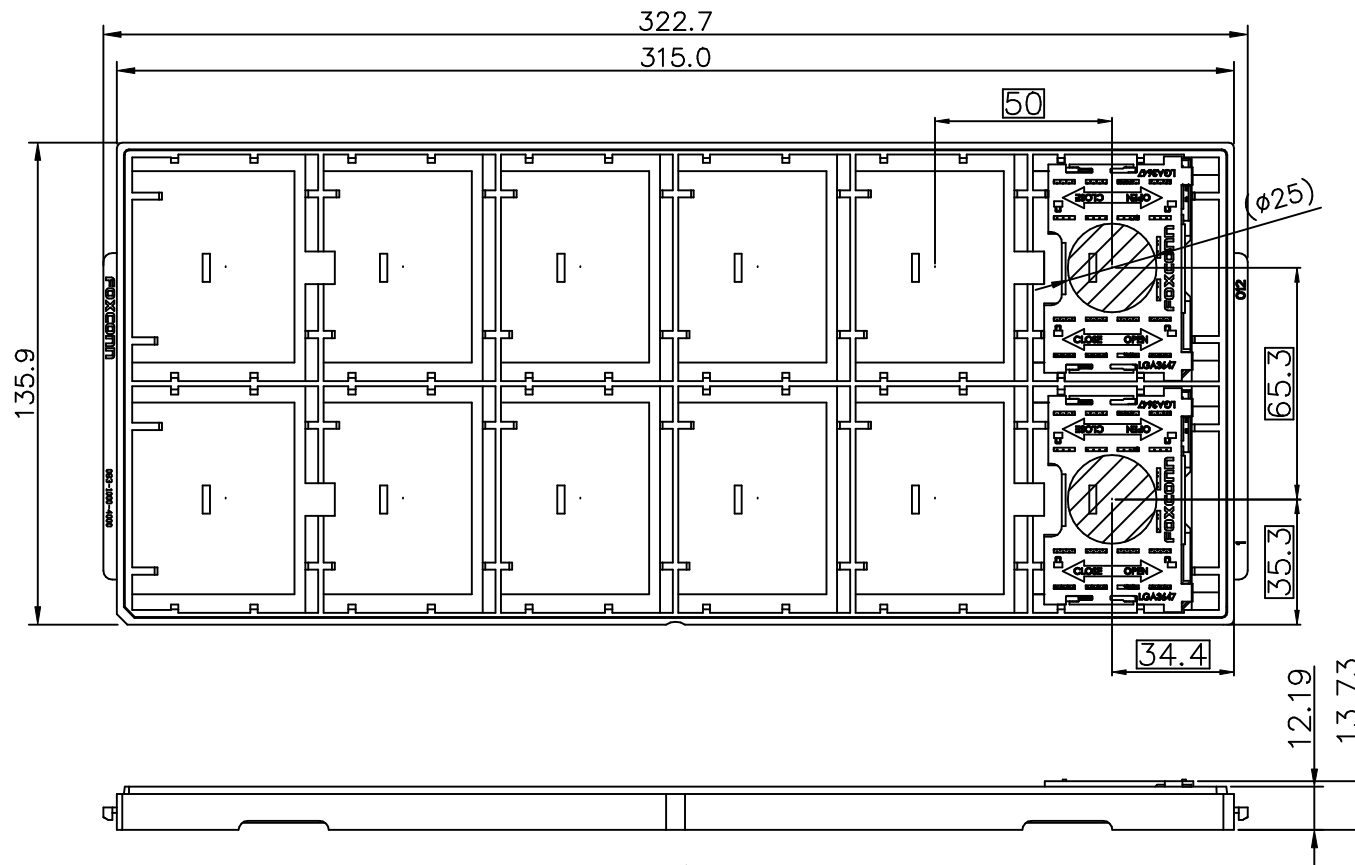

**PACKING TRAY**  
SCALE 1:2

SEGMENT A	BLUE
SEGMENT B	BLACK
DESCRIPTION	HARD TRAY COLOR

X.± 3	X.± 1*	UNITS mm	NAME(INTENDED USE) LGA3647 SOCKET	<b>FOXCONN INTERCONNECT TECHNOLOGY LIMITED.</b>
.X± 0.25	.X*±	MAT'L 	PART NO.(INTENDED USE) PE3647*-*****-1H	
.XX± 0.10	.XX*±	FINISH	APPD: Nick Lin	CLASS: <input type="checkbox"/> CONFIDENTIAL <input type="checkbox"/> SECRET <input checked="" type="checkbox"/> GENERAL
.XXX±	.XXX*±		Q'TY	CHKD: Mac Peng
<small>THESE DRAWINGS AND SPECIFICATIONS ARE THE PROPERTY OF FOXCONN INTERCONNECT TECHNOLOGY LIMITED, AND SHALL NOT BE REPRODUCED, COPIED OR USED IN ANY MANNER WITHOUT THE PRIOR WRITTEN CONSENT OF FOXCONN INTERCONNECT TECHNOLOGY LIMITED.</small>			DRAW: Gohan Wu 01/24'18	DWG NO.: 351-0000-1318

## X-ON Electronics

Largest Supplier of Electrical and Electronic Components

*Click to view similar products for [Memory Card Connectors](#) category:*

*Click to view products by [Foxconn](#) manufacturer:*

Other Similar products are found below :

[6407-249V-25273P](#) [6407-249V-25343P](#) [6426-201-21343](#) [69.920.0553.0](#) [MCR60A-98D-2.54DSA\(70\)](#) [809180410000000](#) [DM3AT-SF-PEJM5\(41\)](#) [IC11S-BUR-PNEJL\(71\)](#) [C70210M0083692](#) [2041353-2](#) [308-DS1P0811-192](#) [HM2P09PDR360N9LF](#) [10014744-011TLF](#) [11327-001](#) [11327-002](#) [NX1-32T-KT3K\(05\)](#) [95622-003LF](#) [84648-056HLF](#) [CCM03-3109 B LFT](#) [MS3116J10-6PW](#) [2309923-1](#) [61126-050CAHLF](#) [GTFP08432B1HR](#) [G85D1160022HHR](#) [SCE2MSDB76A121SN](#) [SCE2MSDZN76A121SN](#) [10014744-011ALF](#) [10014744-011LF](#) [10057542-1211FLF](#) [10067972-000LF](#) [10067972-050LF](#) [10122302-20110LF](#) [G85D1162022HHR](#) [TF-05A](#) [XKNANO-1412](#) [SMN-304-ARP6](#) [MIS11-S1F1-2000-A](#) [MCS-302S-KT1B](#) [K-DYX-008](#) [K-DYX-004](#) [SMO-1030](#) [MCS-110-KT](#) [SIM-217](#) [SNO-1355-KT](#) [SMO-1025-P10](#) [SIM-211S-P6](#) [SNO-1440](#) [SMO-1570](#) [SMO-1550](#) [SIM-212S-8P](#)