

# Micro Reach Xtend™ (NN01- 110) – Bluetooth®, Zigbee®, 802.11 b/g/n WLAN

USER MANUAL

Micro Reach Xtend™ (NN01-110)

## Micro Reach Xtend<sup>™</sup> (NN01-110) – Bluetooth®, Zigbee®, 802.11 b/g/n WLAN

Ignion specializes in enabling effective mobile communications. Using Ignion technology, we design and manufacture optimized antennas to make your wireless devices more competitive. Our mission is to help our clients develop innovative products and accelerate their time to market through our expertise in antenna design, testing and manufacturing.

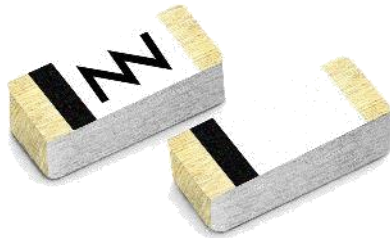

Micro Reach Xtend<sup>™</sup>

NN01-110

Ignion products are protected by [Ignion patents](#).

All information contained within this document is property of Ignion and is subject to change without prior notice. Information is provided “as is” and without warranties. It is prohibited to copy or reproduce this information without prior approval.

Ignion is an ISO 9001:2015 certified company. All our antennas are lead-free and RoHS compliant.

ISO 9001: 2015 Certified



## INDEX OF CHAPTERS

<b>1. ANTENNA DESCRIPTION</b>	<b>5</b>
<b>2. QUICK REFERENCE GUIDE</b>	<b>6</b>
<b>3. ELECTRICAL PERFORMANCE</b>	<b>6</b>
<b>4. MECHANICAL CHARACTERISTICS</b>	<b>11</b>
<b>5. ASSEMBLY PROCESS</b>	<b>12</b>
<b>6. PACKAGING</b>	<b>14</b>
<b>7. PRODUCT CHANGE NOTIFICATION</b>	<b>16</b>

## TABLE OF CONTENTS

<b>1. ANTENNA DESCRIPTION</b>	<b>5</b>
<b>2. QUICK REFERENCE GUIDE</b>	<b>6</b>
<b>3. ELECTRICAL PERFORMANCE</b>	<b>6</b>
<b>3.1. EVALUATION BOARD</b>	<b>6</b>
<b>3.2. MATCHING NETWORK</b>	<b>7</b>
<b>3.3. VSWR AND EFFICIENCY</b>	<b>8</b>
<b>3.4. RADIATION PATTERNS (2.4 – 2.5 GHz), GAIN AND EFFICIENCY</b>	<b>9</b>
<b>3.5. CAPABILITIES AND MEASUREMENT SYSTEMS</b>	<b>10</b>
<b>4. MECHANICAL CHARACTERISTICS</b>	<b>11</b>
<b>4.1. DIMENSIONS AND TOLERANCES</b>	<b>11</b>
<b>4.2. SPECIFICATIONS FOR THE INK</b>	<b>11</b>
<b>4.3. ANTENNA FOOTPRINT</b>	<b>12</b>
<b>5. ASSEMBLY PROCESS</b>	<b>12</b>
<b>6. PACKAGING</b>	<b>14</b>
<b>7. PRODUCT CHANGE NOTIFICATION</b>	<b>16</b>

## 1. ANTENNA DESCRIPTION

The Micro Reach Xtend<sup>™</sup> chip antenna is a very small size and low cost antenna that combines reduced clearance area required within the customer PCB with its high performance and integration flexibility. This makes it ideal for small consumer electronics devices such as small wireless headsets and highly integrated multifunction mobile handsets.

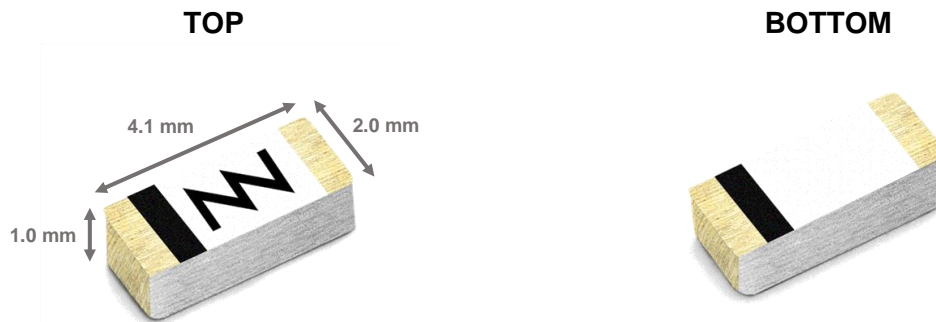

**Material:** The Micro Reach Xtend<sup>™</sup> antenna is built on glass epoxy substrate.

### APPLICATIONS

- Headsets
- Hearing-aids
- USB Dongles
- Medical devices
- Handsets
- Sensors (Proximity, etc.)

### BENEFITS

- Small form factor and footprint
- Reduced clearance area within PCB
- Cost-effective
- Easy to integrate (pick and place)

## 2. QUICK REFERENCE GUIDE

Technical Features	2.4 – 2.5 GHz
Average Efficiency	> 55%
Peak Gain	0.2 dBi
VSWR	< 2.5:1
Radiation Pattern	Omnidirectional
Polarization	Linear
Weight (approx.)	0.02 g
Temperature	-40 to +125° C
Impedance	50 Ω
Dimensions (L x W x H)	4.1 mm x 2.0 mm x 1.0 mm

**Table 1** – Technical Features. Measures from the evaluation board. See Figure 1.

Please contact [support@ignion.io](mailto:support@ignion.io) if you require additional information on antenna integration or optimization on your PCB.

### 3. ELECTRICAL PERFORMANCE

#### 3.1. EVALUATION BOARD

The configuration used in testing the Micro Reach Xtend<sup>™</sup> chip antenna is displayed in Figure 1.

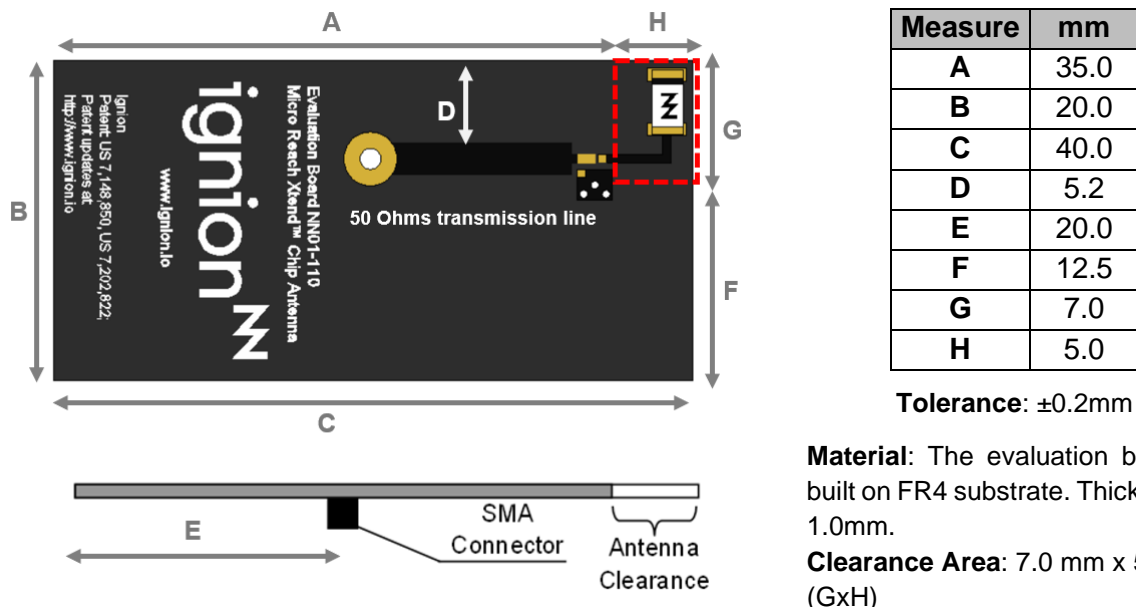

**Figure 1 – EB\_NN01-110.** Micro Reach Xtend<sup>™</sup> Evaluation Board providing operation from 2.4 GHz to 2.5GHz.

This product and/or its use are protected by at least one or more of the following patents US 7,148,850 B2; US 7,202,822 B2.

## 3.2. MATCHING NETWORK

The specs of a Ignion standard antenna are measured in their evaluation board, which is an ideal case. In a real design, components nearby the antenna, LCD's, batteries, covers, connectors, etc affect the antenna performance. This is the reason why it is highly recommended placing pads compatible with 0402 and 0603 SMD components for a PI matching network as close as possible to the antenna feeding point. Do it in the ground plane area, not in the clearance area. This is a degree of freedom to tune the antenna once the design is finished and taking into account all elements of the series (batteries, displays, covers, etc).

Please notice that different devices with different ground planes and different components nearby the Micro Reach Xtend™ chip antenna may need a different matching network. To ensure optimal results, the use of high Q and tight tolerance components is highly recommended (Murata components). If you need assistance to design your matching network beyond this application note, please contact [support@ignion.io](mailto:support@ignion.io), or try our free-of-charge<sup>1</sup> **NN Wireless Fast-Track** design service, you will get your chip antenna design including a custom matching network for your device in 24h<sup>1</sup>. Other related to NN's range of R&D services is available at: <https://www.ignion.io/rdservices/>

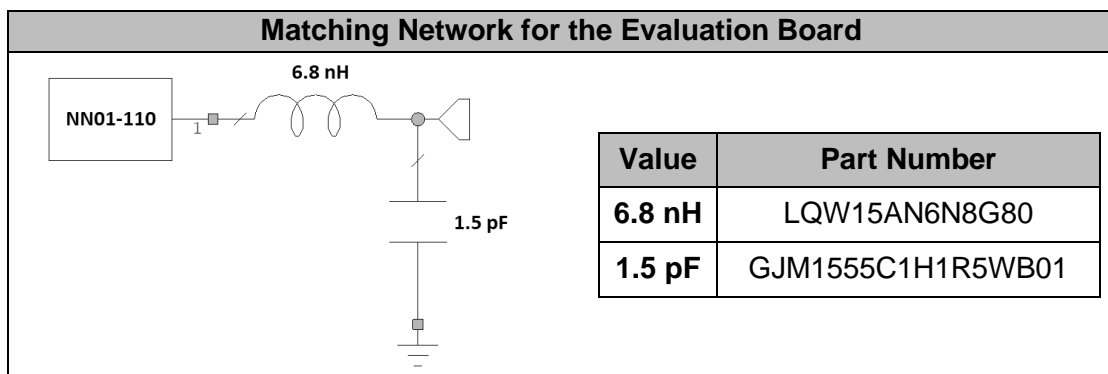
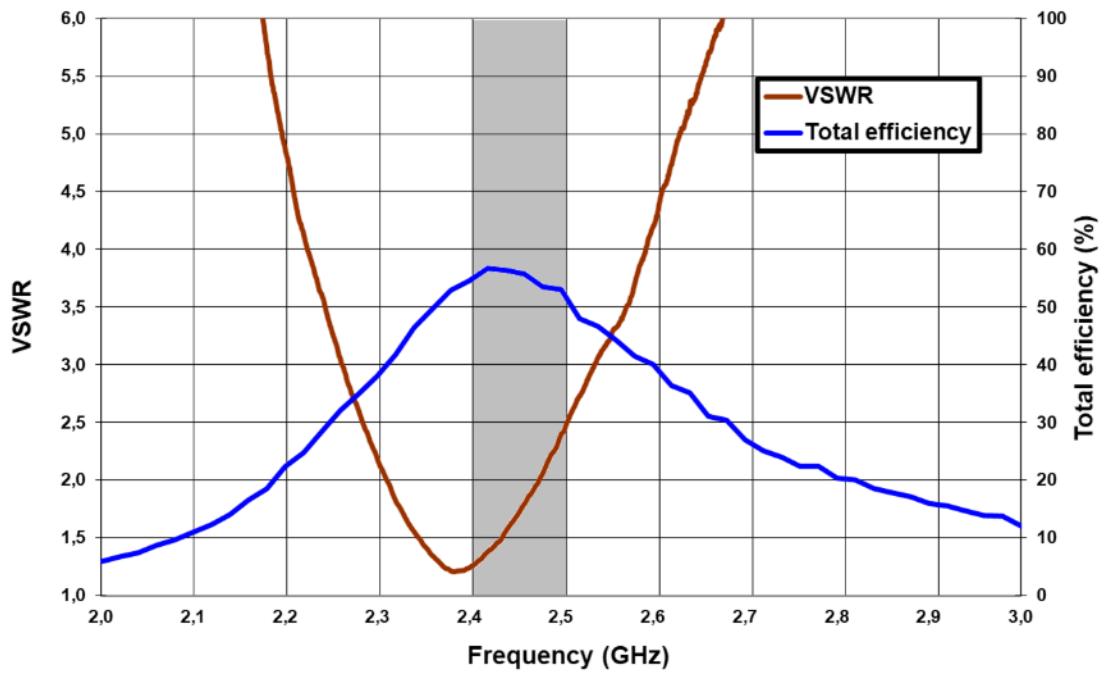

**Figure 2** – Matching network implemented in the evaluation board (Figure 1).

<sup>1</sup> See terms and conditions for a free NN Wireless Fast-Track service in 24h at: <https://www.ignion.io/fast-track-project/>

### 3.3. VSWR AND EFFICIENCY

VSWR (Voltage Standing Wave Ratio) and Total Efficiency versus Frequency (GHz).



**Figure 3** – VSWR and Total Efficiency (%) vs. Frequency (GHz) (from the evaluation board (Figure 1)).



### 3.4. RADIATION PATTERNS (2.4 – 2.5 GHz), GAIN AND EFFICIENCY

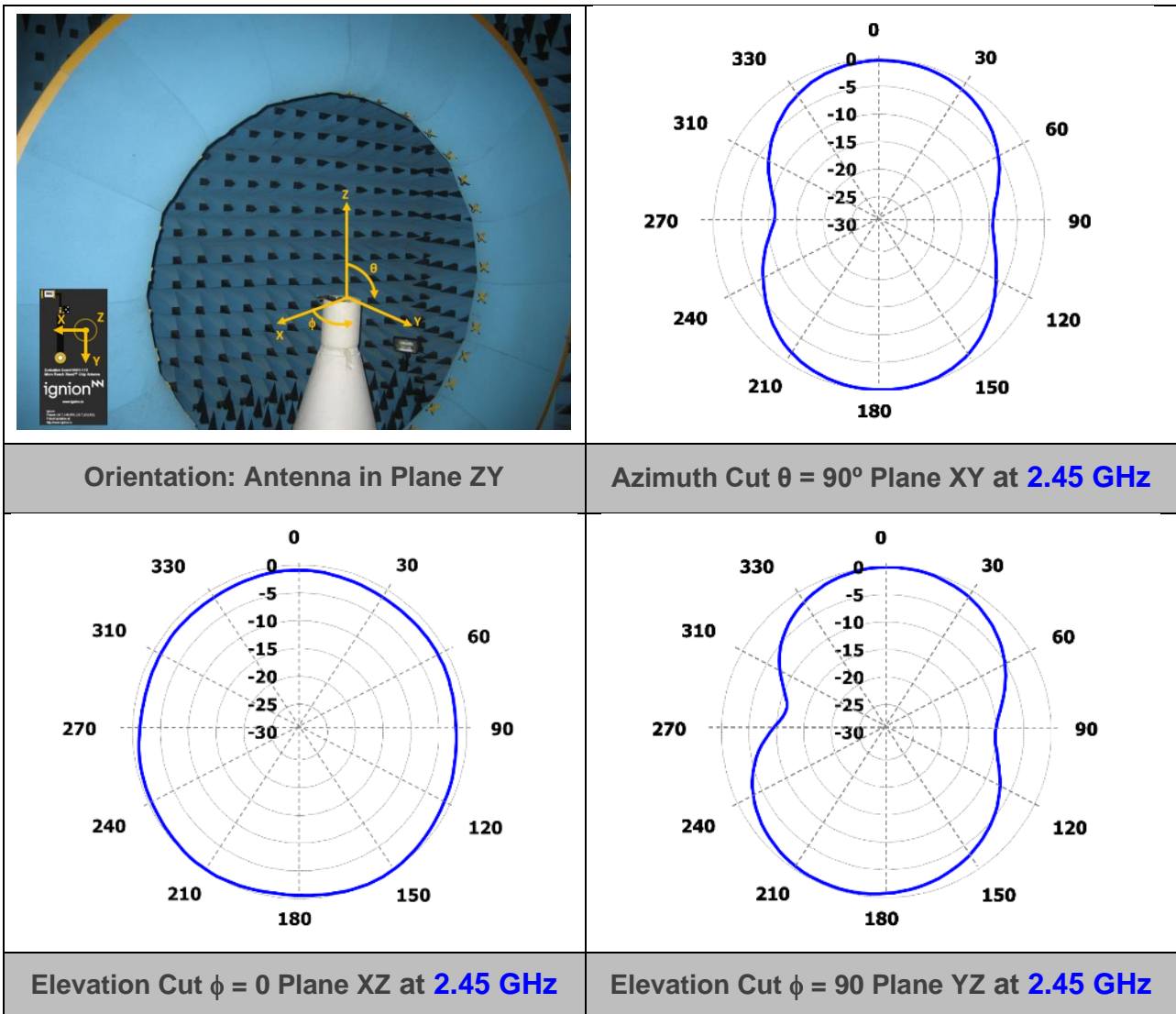

<b>Gain</b>	<b>Peak Gain</b>	0.1 dBi
	<b>Average Gain across the band</b>	-0.2 dBi
	<b>Gain Range across the band (min, max)</b>	-0.6 $\leftrightarrow$ 0.1 dBi
<b>Efficiency</b>	<b>Peak Efficiency</b>	56.7 %
	<b>Average Efficiency across the band</b>	55.2 %
	<b>Efficiency Range across the band (min, max)</b>	53.0 – 56.7 %

**Table 2** – Antenna Gain and Total Efficiency from the evaluation board (Figure 1) within the 2.4 – 2.5 GHz band. Measures made in the evaluation board and in the Satimo STARGATE 32 anechoic chamber.

### 3.5. CAPABILITIES AND MEASUREMENT SYSTEMS

Ignion specializes in the design and manufacture of optimized antennas for wireless applications, and with the provision of RF expertise to a wide range of clients. We offer turn-key antenna products and antenna integration support to minimize your time requirements and maximize return on investment throughout the product development process. We also provide our clients with the opportunity to leverage our in-house testing and measurement facilities to obtain accurate results quickly and efficiently.



**Agilent E5071B**

VSWR  
&  
S Parameters

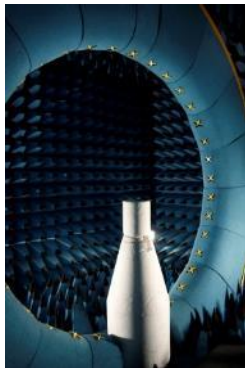
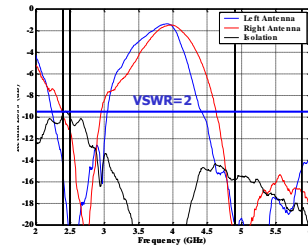

**SATIMO STARGATE 32**

Radiation  
Pattern  
&  
Efficiency

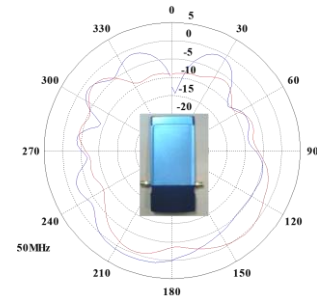

**Anechoic chambers and full equipped in-house lab**

## 4. MECHANICAL CHARACTERISTICS

### 4.1. DIMENSIONS AND TOLERANCES

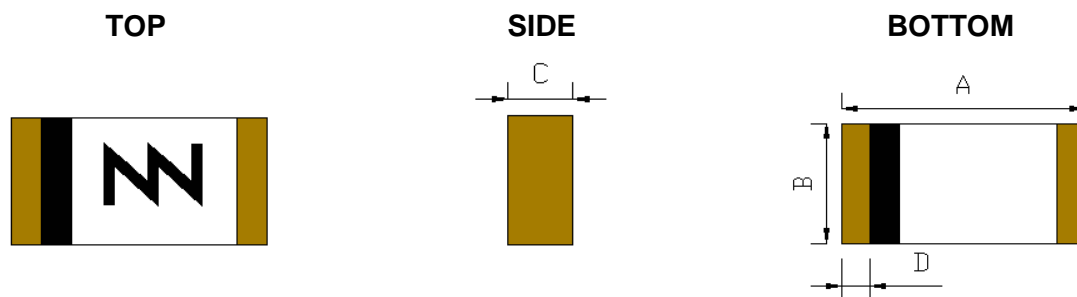

The black line located on the top side of the antenna indicates the feed pad.

Measure	mm
<b>A</b>	4.1 ± 0.2
<b>B</b>	2.0 ± 0.2
<b>C</b>	1.0 ± 0.2
<b>D</b>	0.5 ± 0.1

**Figure 4** – Antenna Dimensions and Tolerances.

The Micro Reach Xtend<sup>™</sup> chip antenna is compliant with the restriction of the use of hazardous substances (**RoHS**). The RoHS certificate can be downloaded from [www.ignion.io](http://www.ignion.io).

### 4.2. SPECIFICATIONS FOR THE INK

Next figure shows the correct colors of the antenna:

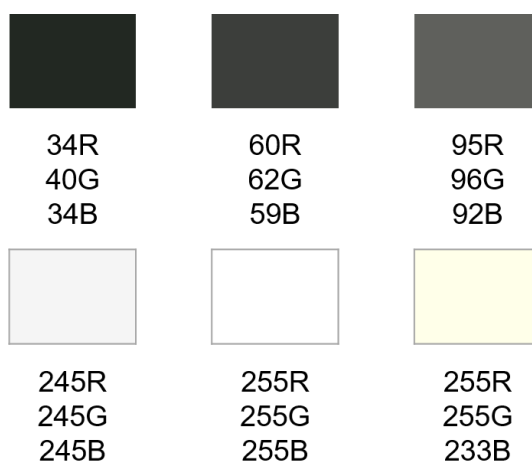

**Acceptable color range**

### 4.3. ANTENNA FOOTPRINT

This antenna footprint applies for the reference evaluation board described on page 6 of this User Manual. Feeding line dimensions over the clearance zone described in Figure 5 apply for a 0.8 mm thickness FR4 PCB.

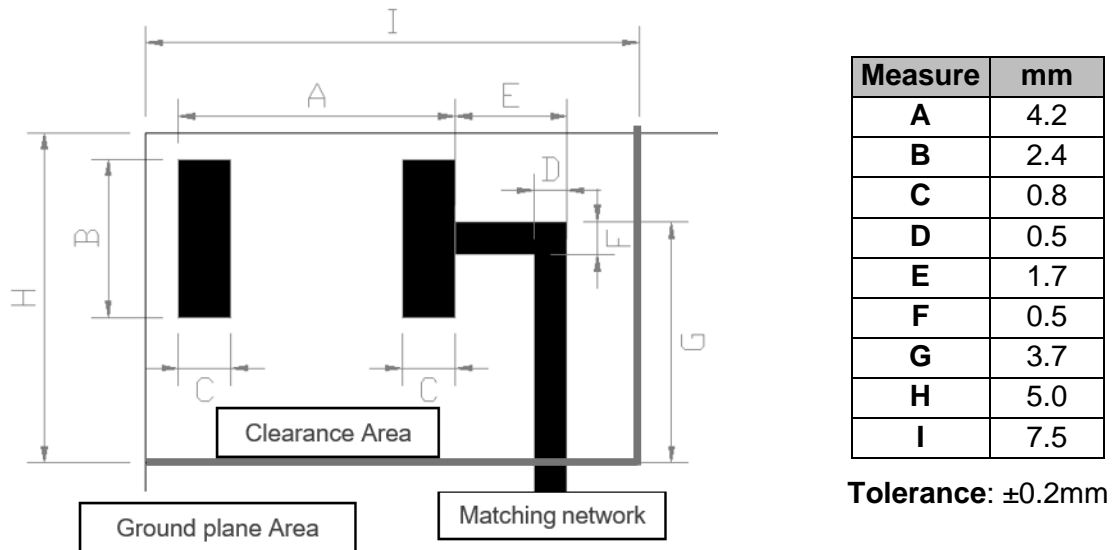

Figure 5 – Antenna Footprint Details.

Other PCB form factors and configurations may require a different feeding configuration, feeding line dimensions and clearance areas. If you require support for the integration of the antenna in your design, please contact [support@ignion.io](mailto:support@ignion.io).

## 5. ASSEMBLY PROCESS

Figure 6 shows the back and front view of the Micro Reach Xtend™ chip antenna, and indicates the location of the feeding point and the mounting pads:

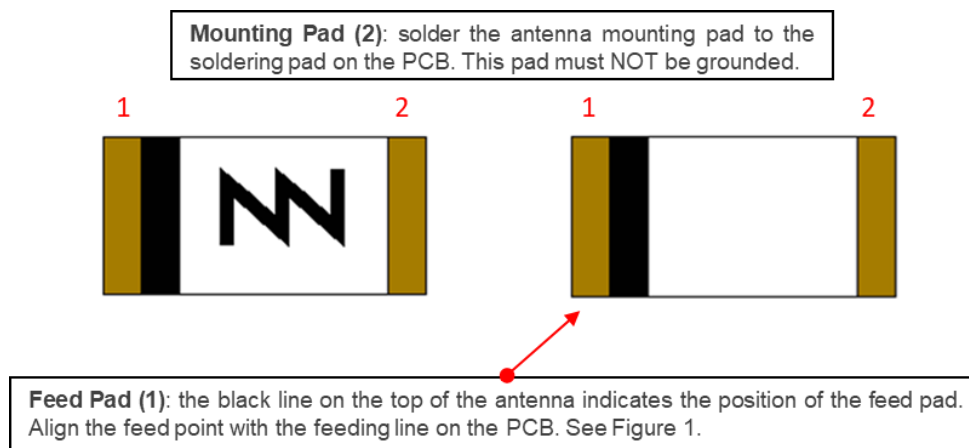
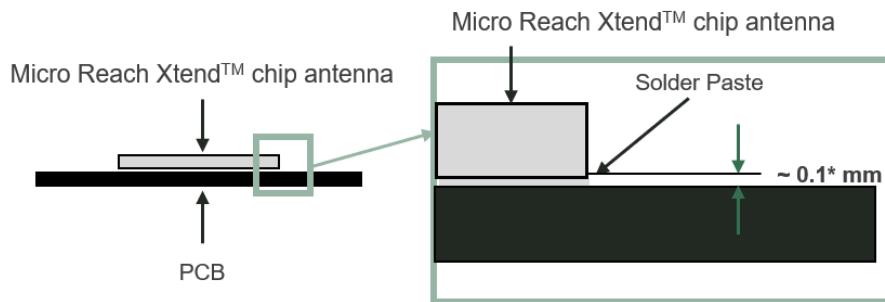

Figure 6 – Pads of the Micro Reach Xtend™ chip antenna.

As a surface mount device (SMD), this antenna is compatible with industry standard soldering processes. The basic assembly procedure for this antenna is as follows:

1. Apply a solder paste to the pads of the PCB. Place the antenna on the board.
2. Perform a reflow process according to the temperature profile detailed in Table 3, Figure 8 on page 14.
3. After soldering the antenna to the circuit board, perform a cleaning process to remove any residual flux. Ignion recommends conducting a visual inspection after the cleaning process to verify that all reflux has been removed.

The drawing below shows the soldering details obtained after a correct assembly process:



**Figure 7 – Soldering Details.**

**NOTE(\*):** Solder paste thickness after the assembly process will depend on the thickness of the soldering stencil mask. A stencil thickness equal to or larger than **127 microns (5 mils)** is required.

The Micro Reach Xtend<sup>™</sup> antenna should be assembled following either Sn-Pb or Pb-free assembly processes. According to the Standard **IPC/JEDEC J-STD-020C**, the temperature profile suggested is as follows:

Phase	Profile features	Pb-Free Assembly (SnAgCu)
<b>RAMP-UP</b>	Avg. Ramp-up Rate (T <sub>smax</sub> to T <sub>p</sub> )	3 °C / second (max.)
<b>PREHEAT</b>	- Temperature Min (T <sub>smin</sub> ) - Temperature Max (T <sub>smax</sub> ) - Time (t <sub>smin</sub> to t <sub>smax</sub> )	150 °C 200 °C 60-180 seconds
<b>REFLOW</b>	- Temperature (T <sub>L</sub> ) - Total Time above T <sub>L</sub> (t <sub>L</sub> )	217 °C 60-150 seconds
<b>PEAK</b>	- Temperature (T <sub>p</sub> ) - Time (t <sub>p</sub> )	260 °C 20-40 seconds
<b>RAMP-DOWN</b>	Rate	6 °C/second max
<b>Time from 25 °C to Peak Temperature</b>		8 minutes max

**Table 3 – Recommended soldering temperatures.**

Next graphic shows temperature profile (grey zone) for the antenna assembly process in reflow ovens.

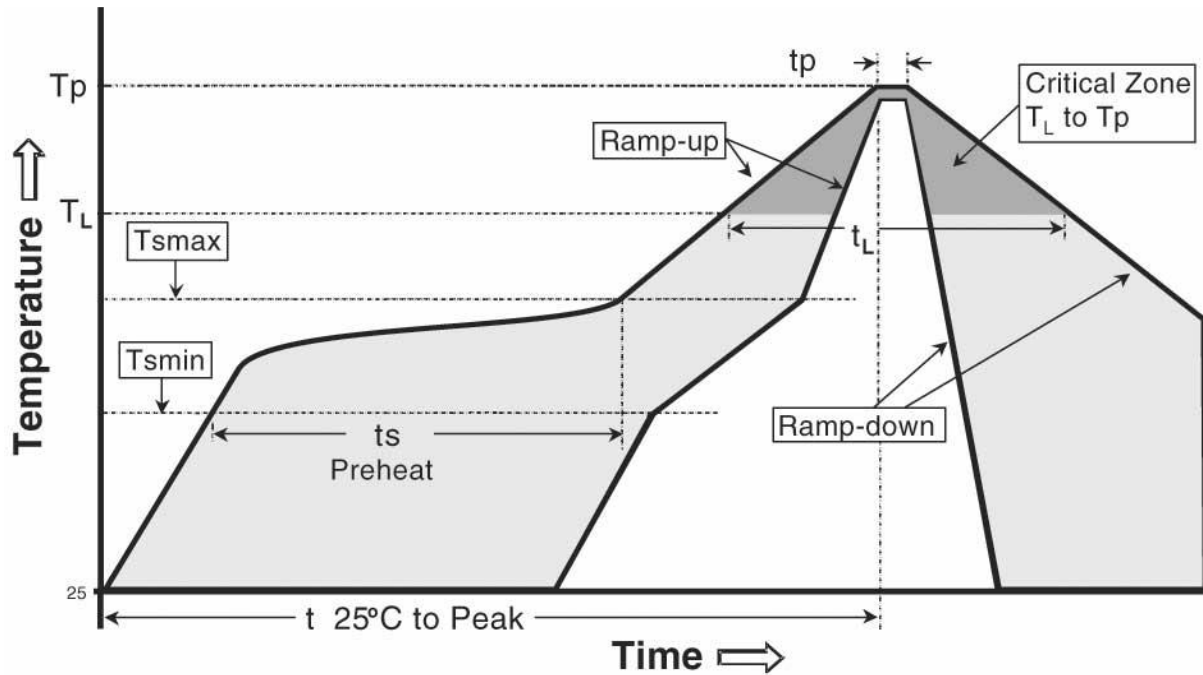

Figure 8 – Temperature profile.

## 6. PACKAGING

The Micro Reach Xtend™ chip antenna is available in tape and reel packaging.

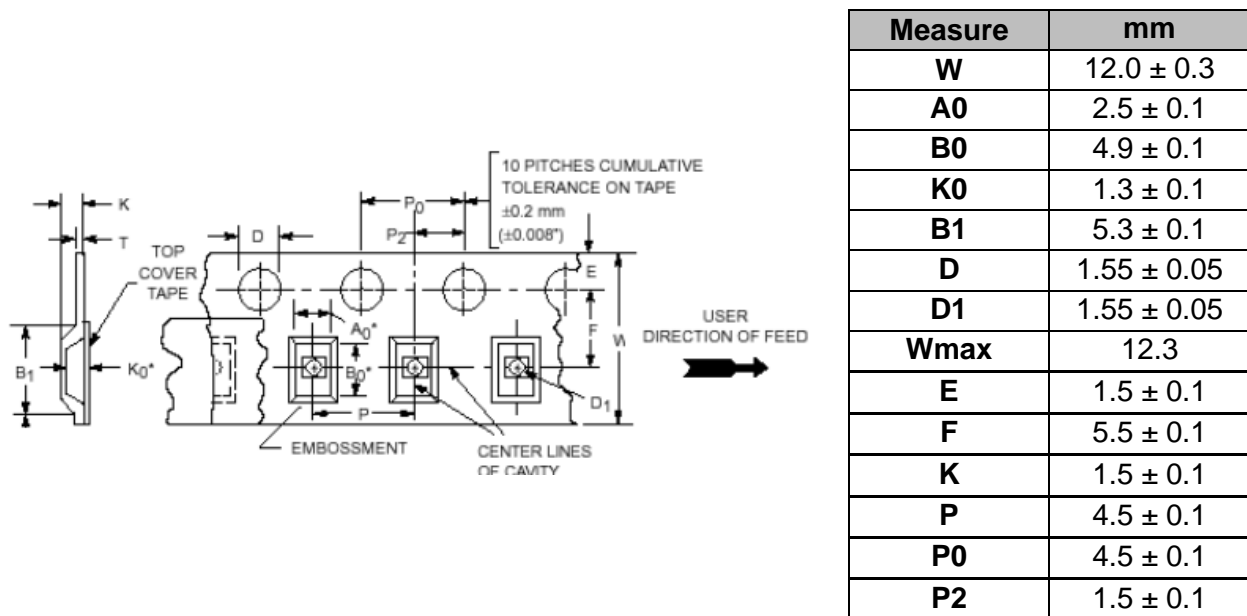

Figure 9 – Tape Dimensions and Tolerances.

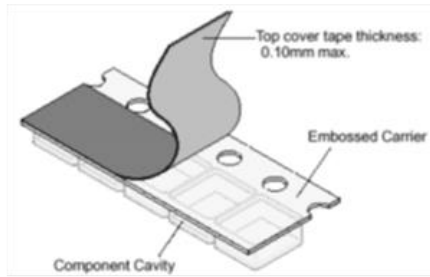
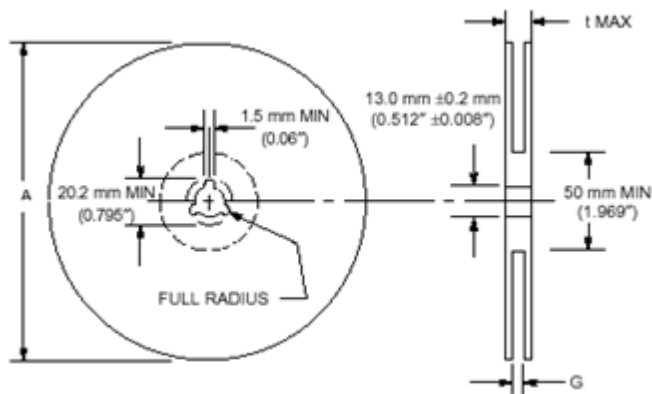

Figure 10 – Images of the tape.



Measure	mm
<b>A max</b>	180.0 ± 1.0
<b>G</b>	13.5 ± 0.2
<b>t max</b>	17.5 ± 0.2

Reel Capacity: 2500 antennas

Figure 11 – Reel Dimensions and Capacity.

## 7. PRODUCT CHANGE NOTIFICATION

This document is property of Ignion,  
Not to disclose or copy without prior written consent

PCN Number: FA18060001

Notification Date: July 8<sup>th</sup>, 2019

### Part Number identification:

Part Number changes, it will be applied in all the document of the company (User Manual, Data Sheet, ...)

Previous Part Number
FR05-S1-N-0-110

New Part Number
NN01-110

### Reason for Change:

<input type="checkbox"/>	Specs (electrical/mechanical)	<input type="checkbox"/>	Manufacturing location
<input type="checkbox"/>	User Manual/Data Sheet	<input type="checkbox"/>	Quality/Reliability
<input type="checkbox"/>	Material/Composition	<input type="checkbox"/>	Logistics
<input checked="" type="checkbox"/>	Processing/Manufacturing	<input checked="" type="checkbox"/>	Other: Logo, product color and Part Number
<input type="checkbox"/>		<input type="checkbox"/>	

### Change description

- 1.- Part Number: From FR05-S1-N-0-110 FRACTUS to NN01-110 Ignion in the User Manual
- 2.- Pads-END: From circular to rectangular
- 3.- Color: From blue/white to white/black



### Comments:

- 1.- Footprint in the PCB to solder the chip antenna remains the same
- 2.- The matching network to properly tune the chip antenna has to be reviewed and validated. It could change

### Identification method

- 1.- The color and the logo are different
- 2.- The pads-end of the antenna from circular to rectangular

User Manual	<input checked="" type="checkbox"/>	Available from: September 2019
Samples	<input checked="" type="checkbox"/>	Available from: September 2019

### Ignion Contact:

Sales  
Name: Josep Portabella  
Email: [josep.portabella@ignion.io](mailto:josep.portabella@ignion.io)

Supply Chain  
Albert Vidal  
[albert.vidal@ignion.io](mailto:albert.vidal@ignion.io)





Your innovation.  
Accelerated.

## Contact:

[support@ignion.io](mailto:support@ignion.io)

+34 935 660 710

### Barcelona

Av. Alcalde Barnils, 64-68 Modul C, 3a pl.  
Sant Cugat del Vallés  
08174 Barcelona  
Spain

### Shanghai

Shanghai Bund Centre  
18/F Bund Centre, 222 Yan'an Road East,  
Huangpu District  
Shanghai, 200002  
China

### New Dehli

New Delhi, Red Fort Capital Parsvnath Towers  
Bhai Veer Singh Marg, Gole Market,  
New Delhi, 110001  
India

### Tampa

8875 Hidden River Parkway  
Suite 300  
Tampa, FL 33637  
USA

## X-ON Electronics

Largest Supplier of Electrical and Electronic Components

*Click to view similar products for [Antenna Development Tools](#) category:*

*Click to view products by [Fractus Antennas](#) manufacturer:*

Other Similar products are found below :

[0868AT43A0020-EB1SMA](#) [EVALBGSA141MN10TOBO1](#) [A10393-U1](#) [PCSD.06.A](#) [B5771-U1](#) [KIT-LTE-GNSS-01](#) [KIT-WIFI-ISM-01](#)  
[A10472-U1](#) [REFLECTOR-EVB-1](#) [A10340-U1](#) [ACAG0201-2450-EVB](#) [ACAG0301-15752450-EVB](#) [ACAG0301-1575-EVB](#) [ACAG0301-24505500-EVB](#) [ACAG0301-5500-EVB](#) [ACAG0801-2450-EVB](#) [ACAG1204-433-EVB](#) [ACAG1204-868-EVB](#) [ACAG1204-915-EVB](#)  
[ACAR0301-SW2-EVB](#) [ACAR3005-C2WB-EVB](#) [ACAR3005-S824-EVB](#) [ACAR3705-S698-EVB](#) [ACAR4008-S698-EVB](#) [A10137-D](#)  
[A10194-U1](#) [A10204-U1](#) [A5645H-EVB-1](#) [A5645-U1](#) [A5887H-EVB-1](#) [A6111-U1](#) [M20057-EVB-1](#) [SR42W001-U1](#) [SR42W009-U1](#)  
[SR4G013-U1](#) [SR4G053-EVB-1](#) [SR4L034-EVB-3](#) [SR4L049-EVB-1](#) [SRC5G027-U1](#) [SRCW004-U1](#) [M310220-01](#) [M830120-01](#) [M830520-01](#)  
[EB\\_NN01-105A](#) [EB\\_NN02-201-5G](#) [CCKLTE450-NA](#) [AEK-GNCP-TH258L15](#) [MPA-104- KIT](#) [MIKROE-4063](#) [MCA100-EVB](#)