



Dual 28 V Input Voltage Charger with Linear Regulator

The 34676 is a dual 28 V input voltage and fully-integrated single cell Li-Ion battery charger, targeting smart handheld applications. One of the inputs is optimized for charging with a USB port, and the second is optimized for an AC/DC adapter power source. The charger has two 28 V power devices, to eliminate the need of any external power source selection and input over-voltage protection circuitry. Each of the power devices independently controls the charge current from the input, and performs as an independent charger. Only one of the two chargers operate at a time.

The AC charger current and the USB charger current are programmable, up to 1.2 A and 400 mA, with an external resistor respectively. The voltage across the two external resistors is also used to monitor the actual charge current through each charger respectively. The EOC current of both chargers is the same, and programmable by an external resistor. The 4.85 V regulator can be used to power a sub-system directly.

The 34676 has a 5% constant current accuracy for the AC Charger over -40 to 85°C, and a 1.0% constant voltage accuracy over -40 to 85°C. A charge current thermal foldback feature, limits the charge current when the IC internal temperature rises to a preset threshold.

Features

- $\pm 1.0\%$ voltage accuracy over -45 to 85°C
- No external MOSFET, reverse blocking diode, or current sense resistor are required
- Additional voltage regulated output powered by USB input
- Battery detection input
- Charge current monitor with thermal limits
- Integrated input over-voltage protection
- Pb-free packaging designated by suffix code EP

34676

BATTERY CHARGER



ORDERING INFORMATION

Device	Temperature Range (T _A)	Package
MC34676BEP/R2	-40°C to 85°C	12-UDFN

Applications

- Cell Phone
- Smart Phone
- PDA, PMP, PND,
- Handheld Portable Devices
- Portable Medical Devices

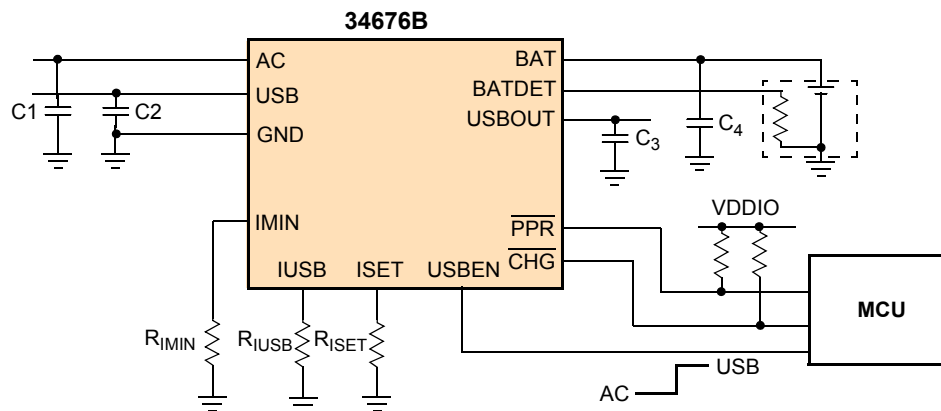

Figure 1. 34676B Simplified Application Diagram

* This document contains certain information on a new product. Specifications and information herein are subject to change without notice.

ARCHIVE INFORMATION

ARCHIVE INFORMATION

INTERNAL BLOCK DIAGRAM

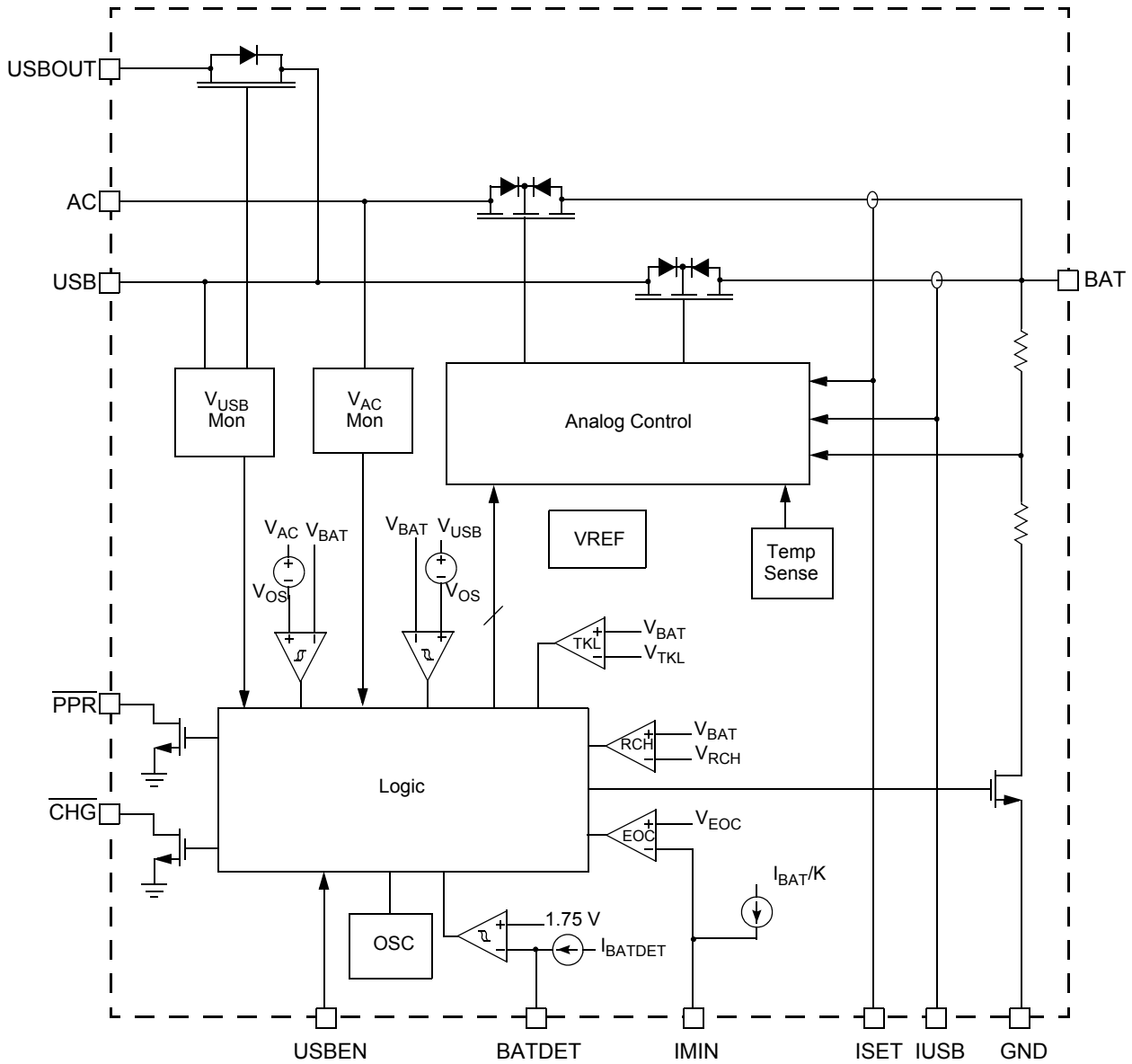

Figure 2. 34676 Simplified Internal Block Diagram

ARCHIVE INFORMATION

ARCHIVE INFORMATION

PIN CONNECTIONS

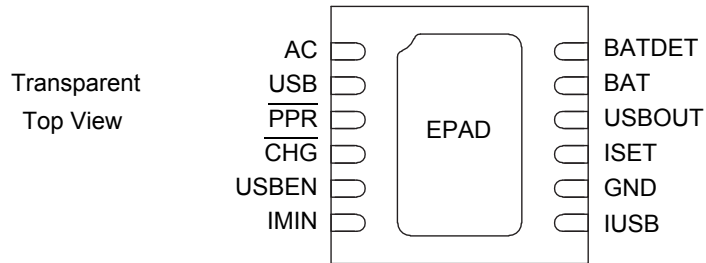

Figure 3. 34676 Pin Connections

Table 1. 34676 Pin Definitions

A functional description of each pin can be found in the Functional Pin Description section beginning on [page 14](#).

Pin Number	Pin Name	Pin Function	Formal Name	Definition
1	AC	Input	AC Input Supply	Power input from an AC/DC adapter.
2	USB	Input	USB Input Supply	Power input from a USB port.
3	$\overline{\text{PPR}}$	Output	Power Present Indicator	Open-drain output to indicate the input power status.
4	$\overline{\text{CHG}}$	Output	Charge Status Indicator	Open-drain output to indicate the charge status.
5	USBEN	Input	Charger Selection	Logic input. Low logic voltage selects the AC charger; high logic voltage selects the USB charger.
6	IMIN	Output	End-of-charge Current Setting	End-of-charge (EOC) current setting.
7	IUSB	Output	USB Charger CC-mode Current Setting and Charger Current Monitor	USB charger CC-mode current setting and charge current monitoring.
8	GND	N/A	Ground	Ground.
9	ISET	Output	AC Charger CC-mode Current Setting and Charge Current Monitor	AC charger CC-mode current setting and charge current monitoring.
10	USBOUT	Output	USB Regulator Output	The USB input 4.85 V linear regulator with 45 mA current output capability.
11	BAT	Output	Charger Output	Charger output. Connect this pin to the battery.
12	BATDET	Input	Battery Detection	Battery connection status detection.
EPAD	EPAD	N/A	Thermal Enhanced PAD	The exposed pad for thermal dissipation enhancement. Must be soldered on the large ground plane on the PCB to increase the thermal dissipation.

ELECTRICAL CHARACTERISTICS

MAXIMUM RATINGS

Table 2. Maximum Ratings

All voltages are with respect to ground unless otherwise noted. Exceeding these ratings may cause a malfunction or permanent damage to the device.

Ratings	Symbol	Value	Unit
ELECTRICAL RATINGS			
Input Supply Voltage Pins	V_{AC}, V_{USB}	-0.3 to 28	V
Charge State Indication Pins	V_{PPR}, V_{CHG}	-0.3 to 12	V
BAT, BATDET, USBEN, USBOUT, ISET, IUSB, IMIN Pins	$V_{BAT}, V_{BATDET},$ $V_{USBEN},$ $V_{USBOUT},$ $V_{ISET}, V_{IUSB},$ V_{IMIN}	-0.3 to 5.5	V
ESD Voltage ⁽¹⁾ Human Body Model (HBM) Machine Model (MM)	V_{ESD}	±2000 ±200	V
THERMAL RATINGS			
Operating Ambient Temperature Range	T_A	-40 to +85	°C
Storage Temperature Range	T_{STG}	-65 to +150	°C
Peak Package Reflow Temperature During Reflow ^{(2), (3)}	T_{PPRT}	Note 3	°C
Maximum Junction Temperature	T_J	+150	°C
Thermal Resistance ⁽⁴⁾ Junction-to-Case Junction-to-Ambient	$R_{\theta JC}$ $R_{\theta JA}$	24 90	°C/W

Notes

- ESD testing is performed in accordance with the Human Body Model (HBM) ($C_{ZAP} = 100$ pF, $R_{ZAP} = 1500$ Ω), and the Machine Model (MM) ($C_{ZAP} = 200$ pF, $R_{ZAP} = 0$ Ω).
- Pin soldering temperature limit is for 10 seconds maximum duration. Not designed for immersion soldering. Exceeding these limits may cause malfunction or permanent damage to the device.
- Freescale's Package Reflow capability meets Pb-free requirements for JEDEC standard J-STD-020C. For Peak Package Reflow Temperature and Moisture Sensitivity Levels (MSL). Go to www.freescale.com, search by part number [e.g. remove prefixes/suffixes and enter the core ID to view all orderable parts. (i.e. MC33xxx enter 33xxx), and review parametrics.
- Device mounted on the Freescale EVB test board per JEDEC DESD51-2.

STATIC ELECTRICAL CHARACTERISTICS

Table 3. Static Electrical Characteristics

Characteristics noted under conditions $V_{AC} = V_{USB} = 5.0\text{ V}$, $-40^{\circ}\text{C} \leq T_A \leq 85^{\circ}\text{C}$, $C_1 = C_2 = C_4 = 1.0\ \mu\text{F}$ and $C_3 = 0.1\ \mu\text{F}$ (See [Figure 1](#)), unless otherwise noted. Typical values noted reflect the approximate parameter means at $V_{AC} = V_{USB} = 5.0\text{ V}$ and $T_A = 25^{\circ}\text{C}$ under nominal conditions, unless otherwise noted.

Characteristic	Symbol	Min	Typ	Max	Unit
POWER-ON RESET (POR)					
AC POR Threshold	V_{PORAC}				V
Rising		3.0	-	3.9	
Falling		-	2.8	-	
USB POR Threshold	V_{PORUSB}				V
Rising		3.0	-	3.9	
Falling		-	2.8	-	
INPUT-BAT OFFSET VOLTAGE (V_{OS})					
AC Input-BAT Offset Voltage Threshold	V_{OSAC}				mV
Rising		-	-	60	
Falling		3.0	-	-	
USB Input-BAT Offset Voltage Threshold	V_{OSUSB}				mV
Rising		-	-	60	
Falling		3.0	-	-	
INPUT OVER-VOLTAGE PROTECTION (OVP)					
AC Input Over-voltage Threshold	V_{OVPAC}				V
Rising		6.6	6.8	7.0	
Falling		6.3	-	-	
AC Input Over-voltage Rising Threshold Hysteresis		-	200	-	mV
USB Input Over Voltage Threshold	V_{OVPUSB}				V
Rising		5.65	5.85	6.1	
Falling		5.55	-	-	
USB Input Over-voltage Rising Threshold Hysteresis		-	60	-	mV
STANDBY CURRENT					
BAT Pin Sink Current Input not powered	I_{STDBY}	-	-	1.0	μA
AC Pin Input Supply Current	I_{ACS}				
Charger disabled		-	-	750	μA
Charger enabled ⁽⁵⁾		-	1.2	-	mA
USB Pin Input Supply Current	I_{USBS}				
Charger disabled		-	-	750	μA
Charger enabled ⁽⁵⁾		-	1.2	-	mA

Notes

- Supply current does not include the current delivered to the battery through the BAT pin.

Table 3. Static Electrical Characteristics (continued)

Characteristics noted under conditions $V_{AC} = V_{USB} = 5.0\text{ V}$, $-40^{\circ}\text{C} \leq T_A \leq 85^{\circ}\text{C}$, $C_1 = C_2 = C_4 = 1.0\ \mu\text{F}$ and $C_3 = 0.1\ \mu\text{F}$ (See [Figure 1](#)), unless otherwise noted. Typical values noted reflect the approximate parameter means at $V_{AC} = V_{USB} = 5.0\text{ V}$ and $T_A = 25^{\circ}\text{C}$ under nominal conditions, unless otherwise noted.

Characteristic	Symbol	Min	Typ	Max	Unit
VOLTAGE REGULATION					
Regulated Output Voltage $I_{BAT} = 10\text{ mA}$, $T_A = 25^{\circ}\text{C}$ $I_{BAT} = 10\text{ mA}$, $T_A = -40\text{ to }85^{\circ}\text{C}$	V_{BAT}	4.184 4.158	4.20 4.20	4.216 4.242	V
AC Charger Power MOSFET ON Resistance ($V_{BAT} = 4.0\text{ V}$, $I_{BAT} = 500\text{ mA}$, $R_{ISET} = 3.75\text{ k}\Omega$)	$R_{DS(ON)AC}$	-	-	500	$\text{m}\Omega$
USB Charger Power MOSFET ON Resistance ($V_{BAT} = 4.0\text{ V}$, $I_{BAT} = 300\text{ mA}$, I_{USB} is floating)	$R_{DS(ON)USB}$	-	-	1000	$\text{m}\Omega$
CHARGE CURRENT					
AC Charger CC-mode Current Range	I_{AC}	0.1	-	1.2	A
AC Charger CC-mode Current Accuracy When set current between 300 mA to 1.2 A When set current between 100 to 300 mA ⁽⁶⁾		95% 90%	100% 100%	105% 110%	I_{AC}
USB Charger CC-mode Current Range When I_{USB} is floating When I_{USB} is pulled down to ground with a resistor	I_{USB}	- 100	400 -	- 400	mA
USB Charger CC-mode Current Accuracy		85%	100%	115%	I_{USB}
AC Trickle Charge Current (% of programmed CC current)	I_{TRKLAC}	16%	20%	24%	I_{AC}
USB Trickle Charge Current (% of programmed CC current)	$I_{TRKLUSB}$	16%	20%	24%	I_{USB}
End-of-Charge Threshold When $R_{IMIN} = 200\text{ k}\Omega$ When $R_{IMIN} = 25\text{ k}\Omega$	I_{EOC}	5.5 60	10 80	12.3 98	mA
Current Slew Rate (On both rising and transitions)	SR	20	-	120	$\text{mA}/\mu\text{s}$
ISET Voltage for I_{AC} Reference	V_{ISET}	-	1.0	-	V
IUSB Voltage for I_{USB} Reference	V_{IUSB}	-	1.0	-	V
IMIN Voltage for I_{EOC} Reference	V_{IMIN}	-	0.5	-	V
CHARGE THRESHOLD					
Recharge Voltage Threshold	V_{RECH}	4.05	4.10	4.15	V
Recharge Voltage Threshold Hysteresis	$V_{RECHHYS}$	-	25	-	mV
Trickle Charge Threshold	V_{TRK}	2.5	2.7	2.8	V
Trickle Charge Threshold Hysteresis	V_{TRKHYS}	-	100	-	mV
CHARGE CURRENT THERMAL FOLDBACK					
Current Foldback Die Temperature Limit	T_{LM}	95	110	125	$^{\circ}\text{C}$

Notes

6. Not tested but guaranteed by design.

Table 3. Static Electrical Characteristics (continued)

Characteristics noted under conditions $V_{AC} = V_{USB} = 5.0\text{ V}$, $-40^{\circ}\text{C} \leq T_A \leq 85^{\circ}\text{C}$, $C_1 = C_2 = C_4 = 1.0\ \mu\text{F}$ and $C_3 = 0.1\ \mu\text{F}$ (See [Figure 1](#)), unless otherwise noted. Typical values noted reflect the approximate parameter means at $V_{AC} = V_{USB} = 5.0\text{ V}$ and $T_A = 25^{\circ}\text{C}$ under nominal conditions, unless otherwise noted.

Characteristic	Symbol	Min	Typ	Max	Unit
USBOUT REGULATOR					
Output Voltage $V_{USB}=5.35\text{ V}$, $I_{USBOUT}=10\text{ mA}$	V_{USBOUT}	4.63	4.85	5.0	V
Dropout Voltage At 45 mA output current		-	-	250	mV
Output Current Limit		46	-	-	mA
Output Pull-down Resistance		-	200	-	k Ω
BATTERY DETECTION INPUT					
Internal Pull-up Current	I_{BATDET}	2.0	4.0	6.0	μA
Comparator Falling Threshold	V_{BATDET}	1.65	1.75	1.85	V
Hysteresis		-	200	-	mV
LOGIC INPUT AND OUTPUT					
USBEN Input High	V_{IH}	1.5	-	-	V
USBEN Input Low	V_{IL}	-	-	0.5	V
USBEN Internal Pull-down Current		-	-	5.0	μA
Open-drain Output Low 10 mA sink current		-	-	0.6	V
PPR and CHG Leakage Current When the Output is High-impedance $V_{CHG} = V_{PPR} = 5.0\text{ V}$		-	-	1.0	μA

ARCHIVE INFORMATION

ARCHIVE INFORMATION

DYNAMIC ELECTRICAL CHARACTERISTICS

Table 4. Dynamic Electrical Characteristics

Characteristics noted under conditions $V_{AC} = V_{USB} = 5.0\text{ V}$, $-40^{\circ}\text{C} \leq T_A \leq 85^{\circ}\text{C}$, $C_1 = C_2 = C_4 = 1.0\ \mu\text{F}$ and $C_3 = 0.1\ \mu\text{F}$ (See [Figure 1](#)), unless otherwise noted. Typical values noted reflect the approximate parameter means at $V_{AC} = V_{USB} = 5.0\text{ V}$ and $T_A = 25^{\circ}\text{C}$ under nominal conditions, unless otherwise noted.

Characteristic	Symbol	Min	Typ	Max	Unit
END-OF-CHARGE					
EOC Filtering Time	t_{EOC}	500	-	1000	ms
OSCILLATOR					
Oscillation Frequency	f_{OSC}	42	50.0	54.5	kHz

ELECTRICAL PERFORMANCE CURVES

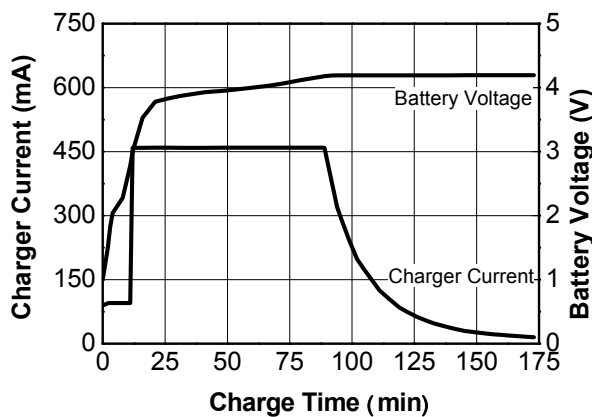

Figure 4. AC Charger Complete Charge Cycle
 $V_{AC} = 5.0\text{ V}$, $R_{ISET} = 5.22\text{ k}\Omega$, 740mAh Battery, $T_A = 25^{\circ}\text{C}$

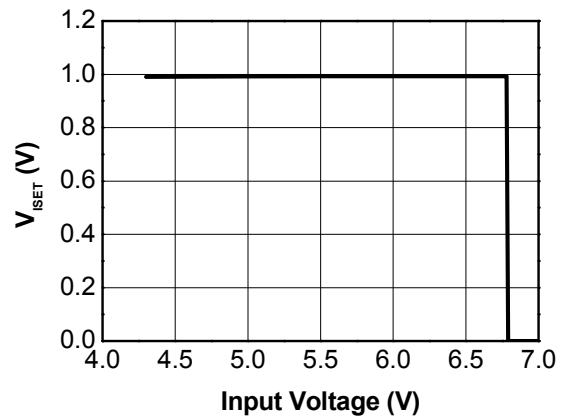

Figure 6. V_{ISET} vs V_{AC}
 $V_{BAT} = 3.7\text{ V}$, $R_{ISET} = 5.22\text{ k}\Omega$, $T_A = 25^{\circ}\text{C}$

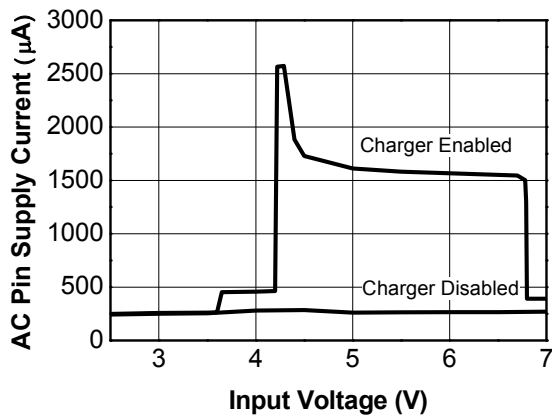

Figure 5. AC Pin Supply Current vs V_{AC}
 $I_{BAT} = 0\text{ mA}$, $T_A = 25^{\circ}\text{C}$

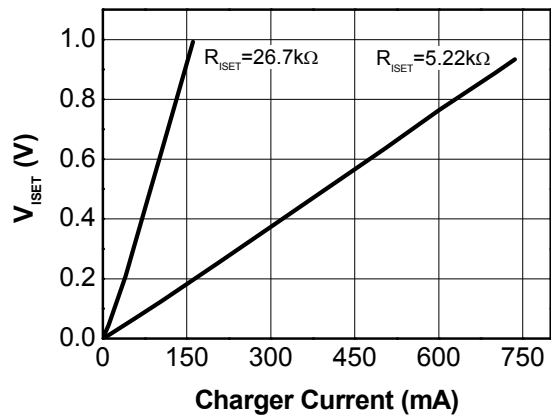

Figure 7. V_{ISET} vs AC Charger Charge Current
 $V_{AC} = 5.0\text{ V}$, $T_A = 25^{\circ}\text{C}$

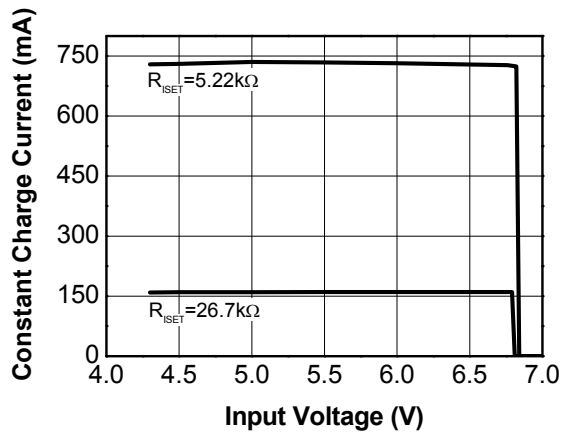

Figure 8. AC Charger CC Current vs V_{AC}
 $V_{BAT}=3.7\text{ V}$, $T_A=25^\circ\text{C}$

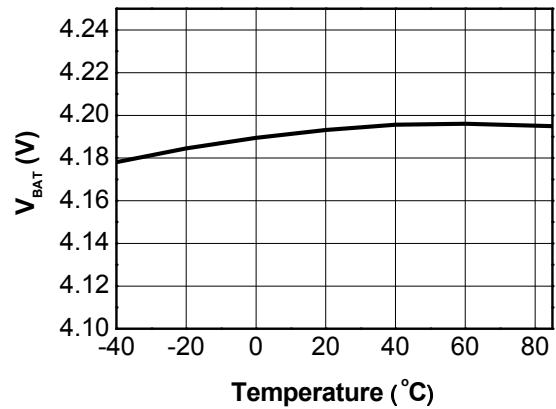

Figure 11. V_{BAT} vs T_A
 $V_{AC}=5.0\text{ V}$, $I_{BAT}=0\text{ mA}$

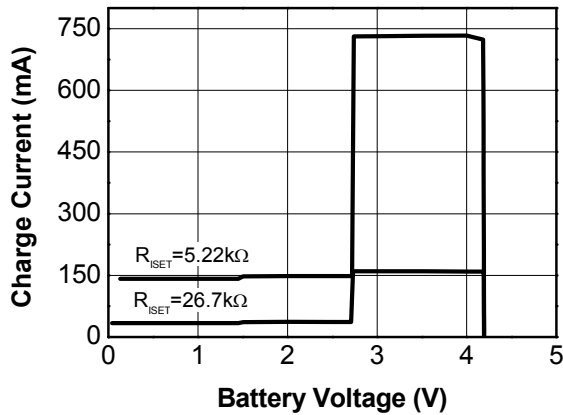

Figure 9. AC Charger Charge Current vs Battery Voltage
 $V_{AC}=5.0\text{ V}$, $T_A=25^\circ\text{C}$

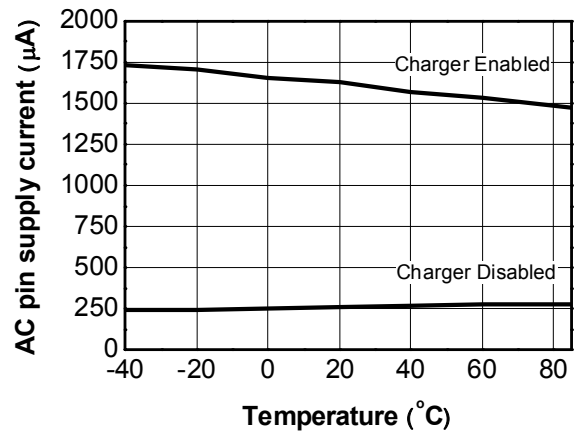

Figure 12. AC Pin Supply Current vs T_A
 $V_{AC}=5.0\text{ V}$, $I_{BAT}=0\text{ mA}$

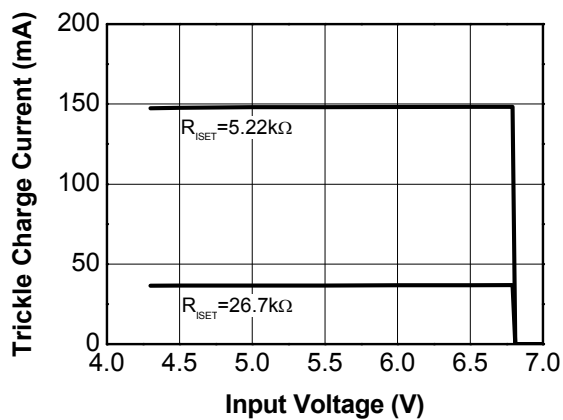

Figure 10. AC Charger Trickle Charge Current vs V_{AC}
 $V_{BAT}=2.0\text{ V}$, $T_A=25^\circ\text{C}$

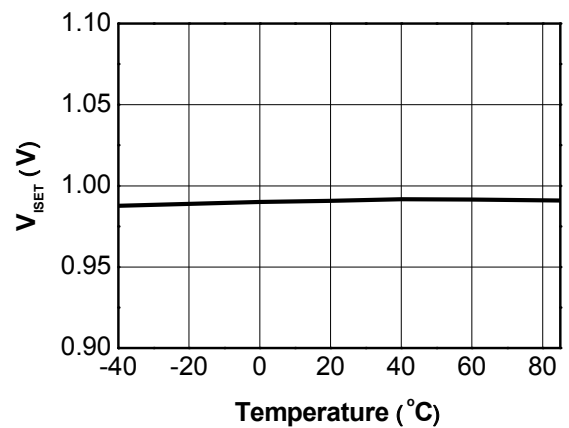

Figure 13. V_{ISET} vs T_A
 $V_{AC}=5.0\text{ V}$, $R_{ISET}=5.22\text{ k}\Omega$, $V_{BAT}=3.7\text{ V}$

ARCHIVE INFORMATION

ARCHIVE INFORMATION

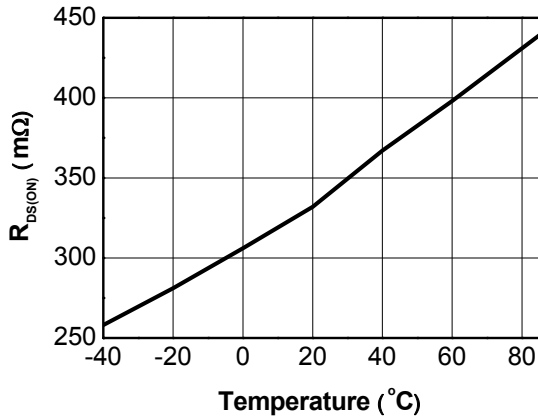

Figure 14. AC Charger $R_{DS(ON)}$ vs T_A
 $V_{BAT}=4.0$ V, $I_{AC}=750$ mA, $I_{BAT}=500$ mA

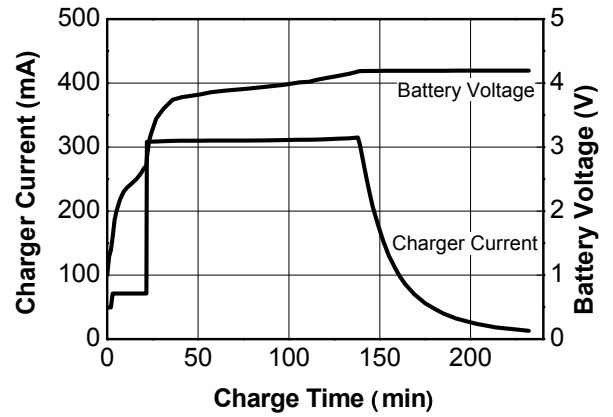

Figure 17. USB Charger Complete Charge Cycle
 $V_{USB}=5.0$ V, $R_{IUSB}=6.52$ k Ω , 740 mA Battery, $T_A=25^\circ$ C

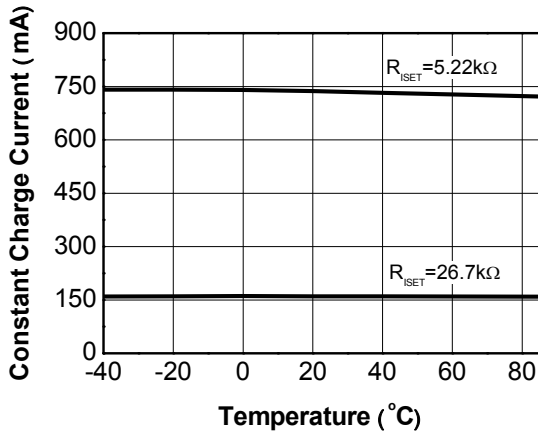

Figure 15. AC Charger CC Current vs T_A
 $V_{AC}=5.0$ V, $V_{BAT}=3.7$ V

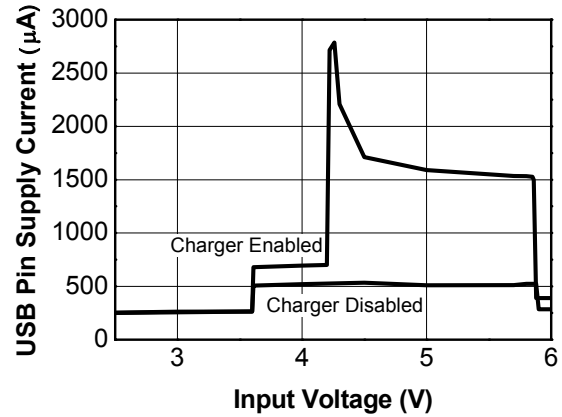

Figure 18. USB Pin Supply Current vs V_{USB}
 $I_{BAT}=0$ mA, $T_A=25^\circ$ C

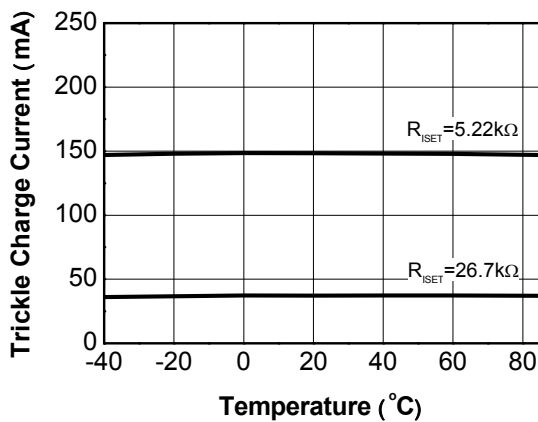

Figure 16. AC Charger Trickle Charge Current vs T_A
 $V_{AC}=5.0$ V, $V_{BAT}=2.0$ V

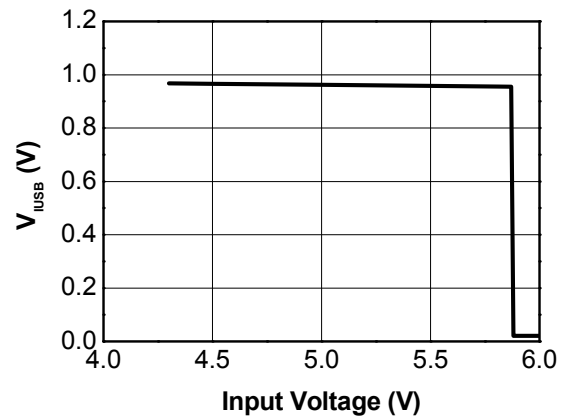

Figure 19. V_{IUSB} vs V_{USB}
 $V_{BAT}=3.7$ V, $R_{IUSB}=9.76$ k Ω , $T_A=25^\circ$ C

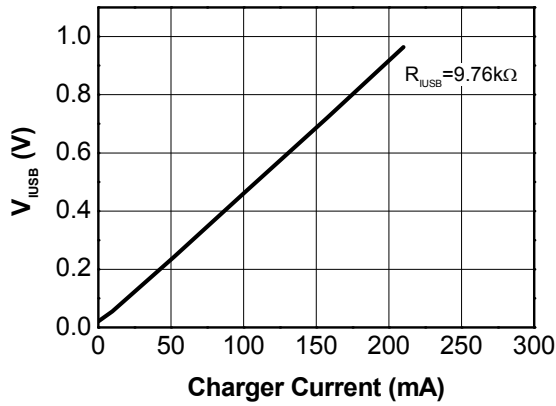

Figure 20. V_{USB} vs USB Charger Charge Current
 $V_{USB}=5.0\text{ V}$, $T_A=25^\circ\text{C}$

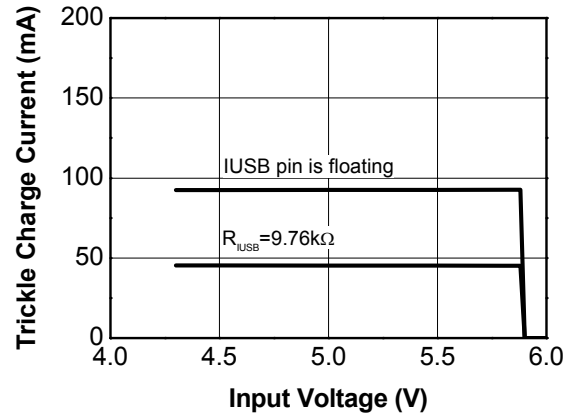

Figure 23. USB Charger Trickle Charge Current vs V_{USB}
 $V_{BAT}=2.0\text{ V}$, $T_A=25^\circ\text{C}$

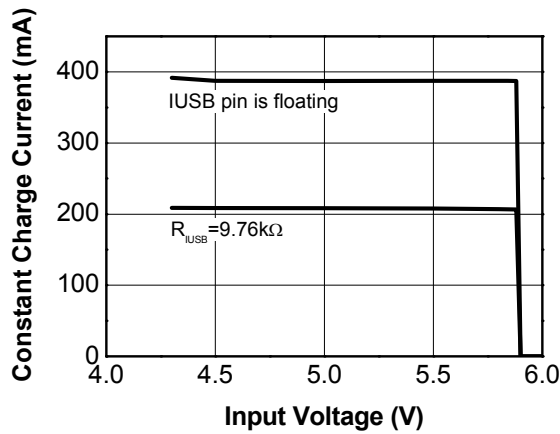

Figure 21. USB Charger CC Current vs V_{USB}
 $V_{BAT}=3.7\text{ V}$, $T_A=25^\circ\text{C}$

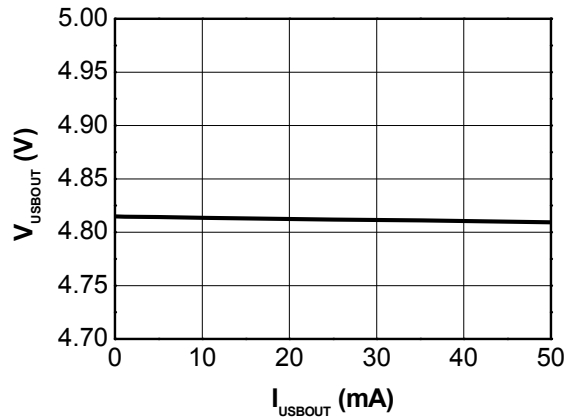

Figure 24. V_{USBOUT} vs I_{USBOUT}
 $V_{USB}=5.0\text{ V}$, $T_A=25^\circ\text{C}$

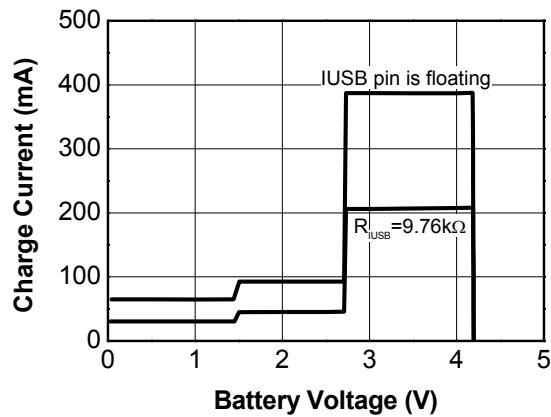

Figure 22. USB Charger Charge Current vs V_{BAT}
 $V_{USB}=5.0\text{ V}$, $T_A=25^\circ\text{C}$

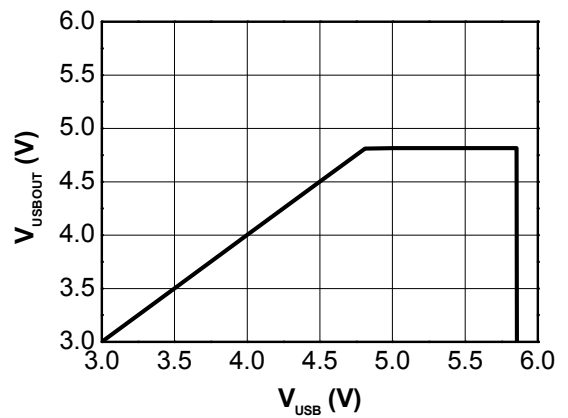

Figure 25. V_{USBOUT} vs V_{USB}
 $I_{USBOUT}=0\text{ mA}$, $T_A=25^\circ\text{C}$

ARCHIVE INFORMATION

ARCHIVE INFORMATION

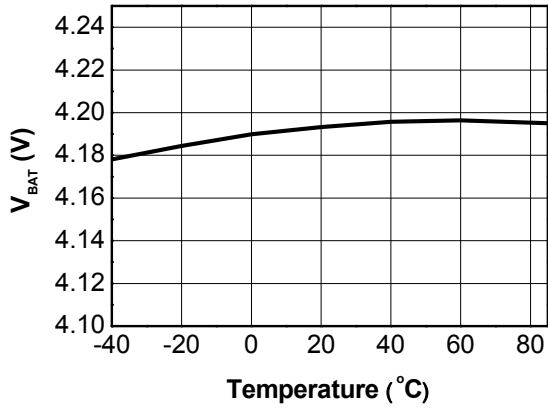

Figure 26. V_{BAT} vs T_A
 $V_{USB}=5.0\text{ V}$, $I_{BAT}=0\text{ mA}$

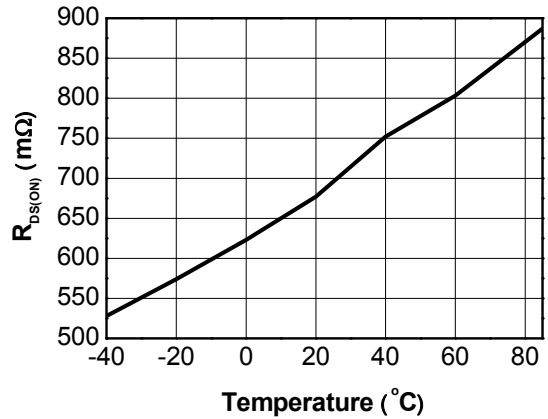

Figure 29. USB Charger $R_{DS(ON)}$ vs T_A
 $V_{BAT}=4.0\text{ V}$, $I_{USB}=400\text{ mA}$, $I_{BAT}=300\text{ mA}$

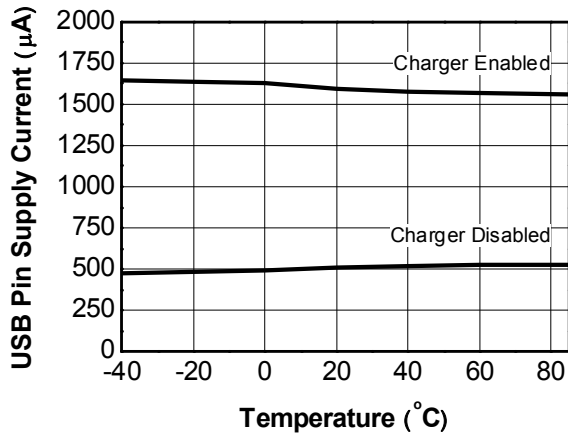

Figure 27. USB Pin Supply Current vs T_A
 $V_{USB}=5.0\text{ V}$, $I_{BAT}=0\text{ mA}$

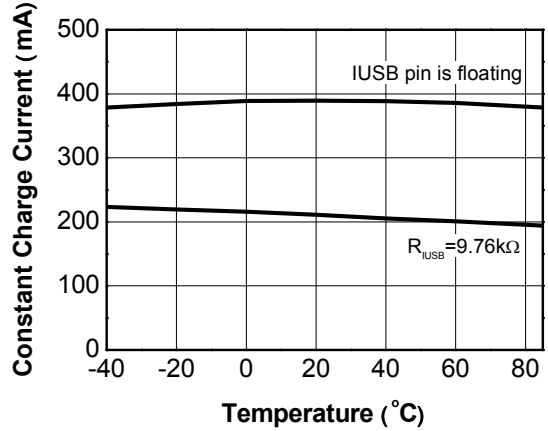

Figure 30. USB Charger CC Current vs T_A
 $V_{USB}=5.0\text{ V}$, $V_{BAT}=3.7\text{ V}$

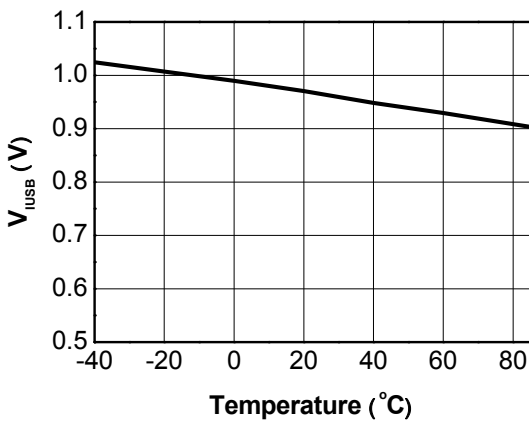

Figure 28. V_{IUSB} vs T_A
 $V_{USB}=5.0\text{ V}$, $R_{IUSB}=9.76\text{ k}\Omega$, $V_{BAT}=3.7\text{ V}$

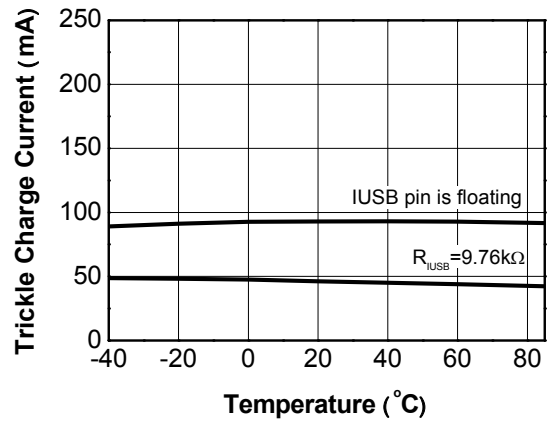

Figure 31. USB Charger Trickle Current vs T_A
 $V_{USB}=5.0\text{ V}$, $V_{BAT}=2.0\text{ V}$

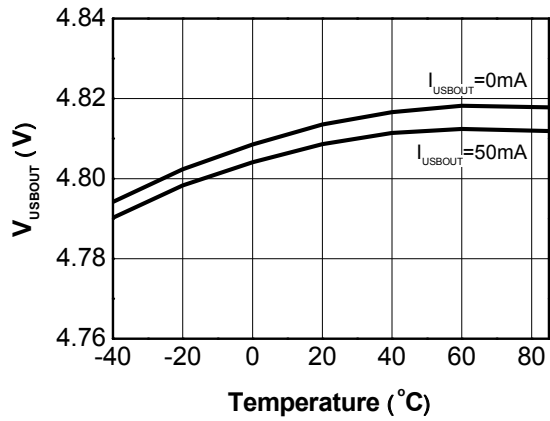

Figure 32. V_{USBOUT} vs T_A
V_{USB}=5.0 V

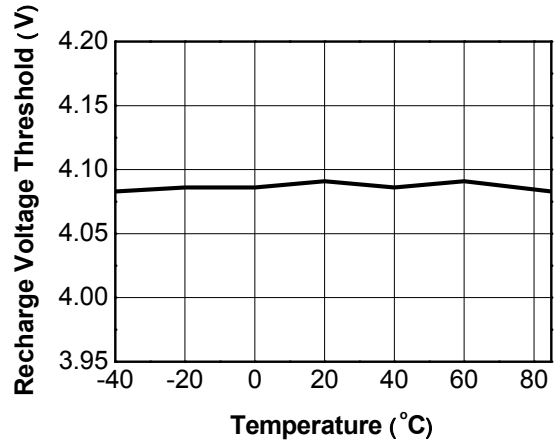

Figure 34. Recharge Voltage Threshold vs T_A
V_{AC}=5.0 V or V_{USB}=5.0 V

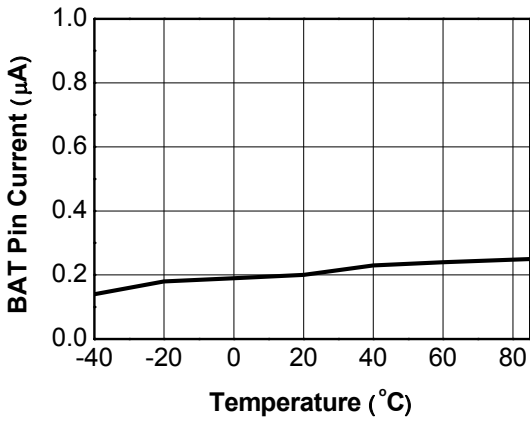

Figure 33. BAT Pin Current vs T_A
V_{BAT}=4.2 V, Input Not Powered or Charger Disabled

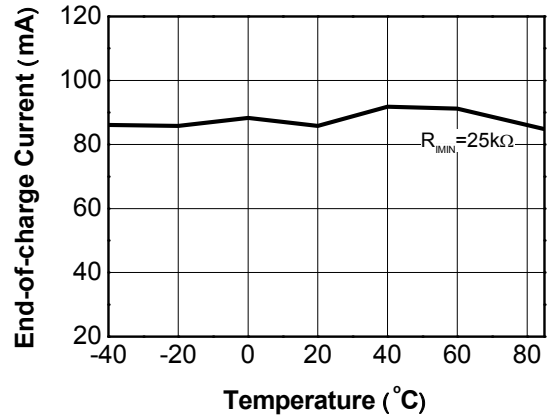

Figure 35. End-of-charge Current vs T_A
V_{AC}=5.0 V or V_{USB}=5.0 V

ARCHIVE INFORMATION

ARCHIVE INFORMATION

FUNCTIONAL DESCRIPTION

INTRODUCTION

The 34676 is a dual 28 V input charger, with 4.85 V regulated voltage output optimized for smart handheld devices. Many smart handheld applications require frequent data exchange between the device and the personal computer via a USB port. It is convenient that the device charges the Li-Ion battery by taking advantage of the 500 mA output current from the USB port, while exchanging the data. In the meantime, the handheld device also needs to be able to charge at a faster rate, when using an AC/DC adapter with higher than 500 mA output current capability. Such applications require a charger that can select one of the two power sources, and charge at a user desired current rate. The 34676 is optimized for such applications.

The 34676 requires only four external capacitors and three resistors to build a fully functional charger for space-limited applications, such as PDAs, cell phones, and digital still cameras. Its ultra high voltage accuracy ($\pm 0.4\%$) and temperature limited charging current, offer additional battery safety during charging.

Two external resistors, R_{IUSB} and R_{ISET} , set the CC-mode current of the USB charger and the CC-mode current of the AC charger respectively. Both the USB charge current and the AC charge current can be monitored during the whole charge cycle, by measuring the voltage across R_{IUSB} and R_{ISET} . For a deeply discharged battery with a voltage lower than 2.7 V, the charger preconditions the battery with 20% of the corresponding CC-mode current. The end-of-charge (EOC) current is set by an external resistor, R_{IMIN} .

The linear regulator provides 4.85 V with 45 mA (USBOUT) current capability. The output is turned on when the voltage of the USB input power supply is above the POR threshold but lower than the OVP threshold. The linear regulator is independent. It is not related to any signals of the charger including the enable input pin.

Two indication outputs (\overline{PPR} , \overline{CHG}) make it easy to report the input power status and the charge status to MCUs or users via LEDs.

FUNCTIONAL PIN DESCRIPTION

AC INPUT SUPPLY (AC)

Power input from an AC/DC adapter. Bypass to ground with a 1.0 μ F capacitor.

USB INPUT SUPPLY (USB)

Power input from a USB port. Bypass to ground with a 1.0 μ F capacitor.

POWER PRESENT INDICATOR (\overline{PPR})

Open-drain output to indicate the input power status. When both the AC and the USB input voltages are under the power-on-reset threshold voltage, or above the over-voltage protection threshold voltage, the \overline{PPR} outputs a high-impedance. In any other conditions, the \overline{PPR} outputs a low voltage.

CHARGE STATUS INDICATOR (\overline{CHG})

Open-drain output to indicate the charge status. The output is low when the 34676 is charging until the EOC conditions are reached.

CHARGER SELECTION (USBEN)

Logic input. This pin selects the AC charger or the USB charger. When driven to low, the AC charger is selected. When driven to high, the USB charger is selected. This pin is internally pulled to ground by a weak current source. The input is equivalent to low when this pin is floating.

END-OF-CHARGE CURRENT SETTING (IMIN)

The end-of-charge current is set by connecting a resistor, R_{IMIN} , between this pin to ground. Both the AC charger and the USB charger have the same EOC current value.

USB CHARGER CC-MODE CURRENT SETTING AND CHARGE CURRENT MONITOR (IUSB)

The CC-mode current of the USB charger is set by connecting a resistor, R_{IUSB} , between this pin and ground. When the USB charger is charging in the constant-current mode, the voltage at this pin is 1.0 V. The voltage reduces proportionally as the charge current reduces in the constant-voltage mode. During the whole charge cycle, the voltage at this pin can be used to monitor the charge current using the following equation:

$$I_{BAT} = \frac{V_{IUSB}}{1.0V} \cdot I_{USB} \quad \text{equ.1}$$

where I_{BAT} is the actual charge current, V_{IUSB} is the voltage at the IUSB pin and I_{USB} is the CC-mode current of the USB charger programmed by the R_{IUSB} .

When this pin is floating, the CC-mode current of the USB charger is set to a default value of 400 mA.

GROUND (GND)

Ground.

AC CHARGER CC-MODE CURRENT SETTING AND CHARGE CURRENT MONITOR (ISET)

The CC-mode current of the AC charger is set by connecting a resistor, R_{ISET} , between this pin and ground. When the AC charger is charging in the constant-current mode, the voltage at this pin is 1.0 V. The voltage reduces proportionally as the charge current reduces in the constant-voltage mode. During the whole charge cycle, the voltage at this pin can be used to monitor the charge current using the following equation:

$$I_{BAT} = \frac{V_{ISET}}{1.0V} \cdot I_{AC} \quad \text{equ.2}$$

where I_{BAT} is the actual charge current, V_{ISET} is the voltage at the ISET pin and I_{AC} is the CC-mode current of the AC charger programmed by the R_{ISET} .

USB REGULATOR OUTPUT (USBOUT)

The USB regulator output pin. The USB linear regulator is powered by the USB input. The output voltage is 4.85 V and

the output current capability is 45 mA. The USB regulator is enabled when the USB input voltage is between the POR and the OVP thresholds. Bypass to ground with a 0.1 μ F or higher capacitor.

CHARGER OUTPUT (BAT)

Charger output pin. Connect this pin to the battery being charged. Bypass to ground with a 1.0 μ F or higher capacitor.

BATTERY DETECTION (BATDET)

Battery detection input. This input has a threshold of 1.75 V. When the input voltage is lower than the threshold, the charger is enabled. An internal 4.0 μ A pull-up current source pulls the voltage higher than the threshold if this pin is floating.

EXPOSED PAD (EPAD)

The exposed pad needs to be connected to GND. It must be soldered on a large ground plane on the PCB to enhance the thermal dissipation.

FUNCTIONAL INTERNAL BLOCK DESCRIPTION

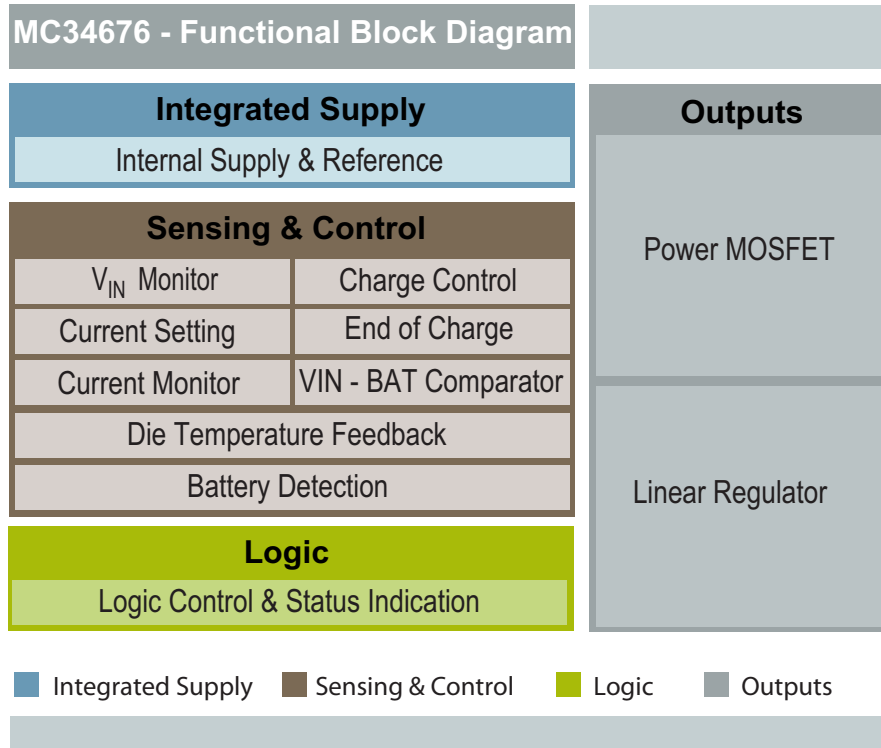

Figure 36. 34676 Functional Internal Block Diagram

OUTPUTS

POWER MOSFET

The power MOSFET function contains two power MOSFETs that pass the charging current from the inputs (AC or USB) to the output (BAT).

LINEAR REGULATOR

The linear regulator outputs a regulated 4.85 V from the USB input voltage with 45 mA (USBOUT) current capabilities. The regulator is only controlled by the power supply input. It is not controlled by the enable input or any other input signals. When the USB power supply input is powered, the Input Voltage Monitor and the Internal Supply blocks detect that the input voltage is greater than the POR rising threshold, and lower than the OVP threshold, the regulator is enabled and outputs 4.85 V.

INTEGRATED SUPPLY

INTERNAL SUPPLY & REFERENCE

This block steps down the high input voltage to a lower voltage to power all the internal blocks.

SENSING & CONTROL

V_{IN} MONITOR

The input voltage monitor block monitors the AC input and the USB input voltages. If any input voltage is lower than its POR or higher than its OVP threshold, this block outputs a logic signal to disable the corresponding charger.

VIN – BAT COMPARATOR

The input and battery voltage comparator monitors the voltage difference between the input voltage and the battery voltage. The input voltage has to be higher than the battery voltage for the charger to be enabled. If the voltage of the AC input or the USB input falls below the battery voltage, this block outputs a signal to disable the corresponding charger to prevent the leakage current from the battery to the input.

CHARGE CONTROL

The charge control block controls the gate voltage of the power MOSFETs to regulate the charge current, the battery voltage, or the die temperature. It can also completely turn off the power MOSFETs to stop the current flow between the input and the battery.

DIE TEMPERATURE SENSE

The die temperature sense block monitors the die temperature. Once the die temperature reaches the

ARCHIVE INFORMATION

ARCHIVE INFORMATION

threshold temperature, this block tries to reduce the charge current to prevent further die temperature rise.

CHARGE CURRENT SETTING AND CURRENT MONITOR

This block sets the CC-mode charge current and monitors the actual charge current of both the AC charger and the USB charger during the whole charge cycle.

END OF CHARGE (EOC) CURRENT SETTING

The EOC current setting block sets the EOC current of both the AC charger and the USB charger.

BATTERY DETECTION

This block detects the connection status of the battery. It is also an enable input for the 34676.

LOGIC

LOGIC CONTROL AND STATUS INDICATION

The logic control block determines the on and off of the charger, based on the signals from the Input Voltage Monitor block, the Internal Supply block, the Input and Battery Voltage Comparator block, the charger selection pin, and the external enable input pin.

FUNCTIONAL DEVICE OPERATION

OPERATIONAL MODES

The 34676 uses the standard charge profile with trickle mode, constant-current (CC) mode, and constant-voltage (CV) mode, as shown in Figure 37. Both the CC-mode and the CV-mode are called fast charge mode. Figure 40 shows the complete charge cycle state diagram.

When the input voltage rises above the internal power-on-reset threshold and is less than its OVP threshold, the PPR pin outputs a logic low level to indicate the power supply presence. The charger starts to verify the enable input (BATDET input). If it is enabled, the charger will start with the trickle mode until the battery voltage is above 2.7 V. The CHG pin turns to logic low level at the beginning of the trickle mode. If the battery voltage is unable to rise due to a battery failure, the charging will remain in the trickle-charge mode. When the battery voltage reaches the 2.7 V threshold, the 34676 softly changes to the CC-mode. The soft transition minimizes the input voltage drop and reduces the requirement of the input decoupling capacitance. When the battery voltage reaches 4.2 V, the 34676 enters the CV-mode and regulates the output voltage at 4.2 V. The charge

current decreases gradually in the CV-mode. When the current drops to the EOC current threshold, the 34676 outputs a logic high level at the CHG pin, to indicate that the charger has entered into the charge completion mode.

After the charge is completed, the 34676 continues to regulate the output to 4.2 V. If a load is in parallel with the battery, the charger continues to output the current to the load even the charge is completed. When the battery voltage is below the recharge voltage threshold of 4.10 V, the 34676 returns to the fast charge mode and indicates a low signal at the CHG pin.

When one of the following conditions happen, the chargers stop charging and enter disable mode.

1. $V_{IN} > V_{OVP}$
2. $V_{IN} - V_{BAT} < V_{OS}$
3. The voltage at BATDET pin is higher than 1.75 V where V_{IN} can be either the AC or the USB input voltage.

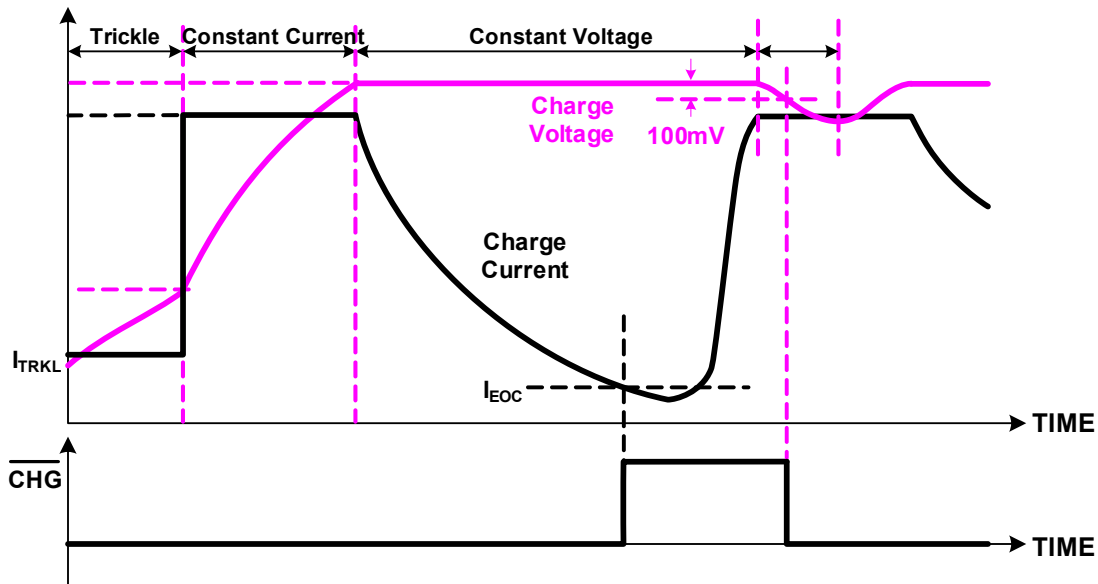

Figure 37. Typical Charge Cycle

DETAILED FUNCTIONAL DEVICE OPERATION

DC 28V INPUT

The 34676 consists of two power MOSFETs, as shown in [Figure 38](#), that act as power source selection devices and pass the charge current from input to output. Both inputs are capable of withstanding up to 28 V DC input. The charger only charges when the input voltage is in a power-good range.

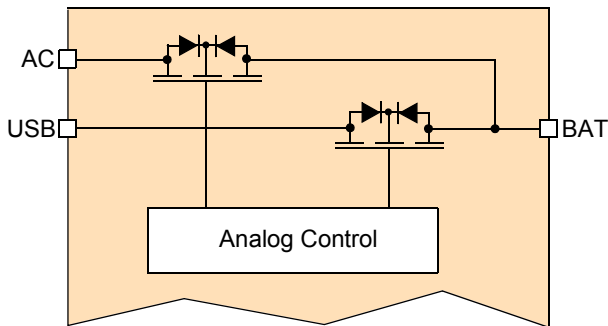

Figure 38. Dual Internal Power MOSFETs

The input voltage is defined as being in a power-good range when satisfying all following three conditions:

1. $V_{IN} > V_{POR}$
2. $V_{IN} - V_{BAT} > V_{OS}$
3. $V_{IN} < V_{OVP}$

where V_{IN} can be either the AC or the USB input voltage.

Only one of the two inputs is selected as the power source to charge the battery at a time. The AC input is selected if the USBEN voltage is a low logic level, and the USB input is selected when the USBEN voltage is high logic level.

DC INPUT INDICATOR

The 34676 uses \overline{PPR} pin to indicate the DC input power presence. When both the AC and the USB input voltages are under the power-on-reset threshold voltage, or above the over-voltage protection threshold voltage, the \overline{PPR} outputs high-impedance. In any other conditions, the \overline{PPR} outputs low voltage. The \overline{PPR} output is only controlled by the input voltage. All other functions, such as the enable signal and the Input-and-Battery-Voltage Comparator, do not affect the \overline{PPR} output.

AC CHARGE CURRENT SETTING

An external reference resistor between the ISET pin and ground sets the CC-mode charge current of the AC charger by the following equation:

$$I_{AC} = \frac{3950}{R_{ISET}} \quad \text{equ.3}$$

where R_{ISET} is the resistance between the ISET pin and ground. In addition, the current out of the ISET pin is also proportional to the charge current. The system may measure the ISET pin voltage to monitor the actual charge current, as given in [equ.2](#), during the whole charging cycle.

USB CHARGE CURRENT SETTING

An external reference resistor between the IUSB pin and ground sets the CC-mode charge current of the USB charger by the following equation:

$$I_{USB} = \frac{1975}{R_{IUSB}} \quad \text{equ.4}$$

where R_{IUSB} is the resistance between the IUSB pin and ground. In addition, the current out of the IUSB pin is also proportional to the charge current. The system may measure the IUSB pin voltage to monitor the actual charge current, as given in [equ.1](#), during the whole charging cycle.

CHARGE CURRENT LIMIT

The charge current is limited by multiple factors.

When the voltage difference between the input and the battery ($V_{AC} - V_{BAT}$ or $V_{USB} - V_{BAT}$) is low, $(V_{AC} - V_{BAT})/R_{DS(ON)AC}$ or $(V_{USB} - V_{BAT})/R_{DS(ON)USB}$ may be less than the corresponding programmed CC-mode current. The charge current is, in this case, limited by $(V_{AC} - V_{BAT})/R_{DS(ON)AC}$ or $(V_{USB} - V_{BAT})/R_{DS(ON)USB}$.

When the voltage difference between the input and the battery is too high, the large power dissipation may lead to the thermal-foldback operation due to the die-temperature regulation. The charge current is reduced to prevent further temperature rise (See the [Thermal current foldback](#) section for more information).

OVER-VOLTAGE PROTECTION (OVP)

Both the USB charger and the AC charger have an OVP threshold as specified in the [Static Electrical Characteristics](#) table. When an input voltage is higher than its OVP threshold, the input voltage does not meet the power-good condition, and cannot be selected as the input power source. However, the other input power source may still be in the power-good range and charge the battery. The \overline{PPR} pin outputs high-impedance if both inputs are above its OVP threshold.

INPUT AND BATTERY VOLTAGE COMPARATOR

The input and battery voltage comparator monitors the voltage difference between the input voltage and the battery voltage, as shown in [Figure 2](#). The input voltage has to be higher than the battery voltage, for the charger to be enabled. If the input voltage falls below the battery voltage, this block outputs a signal to disable the charger, to prevent the leakage current from the battery to the input. Due to the intrinsic input offset voltage of the comparators, a small positive voltage, V_{OS} , is added. Thus the power MOSFET can be turned on only when the input voltage is higher than the battery voltage by V_{OS} . On the other hand, the added V_{OS} guarantees that the power MOSFET is turned off when the input voltage is lower than the battery voltage.

CHARGER SELECTION INPUT

The USBEN selects either the AC or the USB charger. When the USBEN is driven to a low logic level, the AC charger is selected. When the USBEN is driven to a high-logic level, the USB charger is selected. The USBEN is internally pulled low by a weak current source.

BATTERY DETECTION INPUT

The battery detection input, BATDET, detects the connection of the battery, and is an enable input for the charger. The BATDET comparator has a threshold of 1.75 V (typical). When this pin is driven below this threshold, the charger is enabled. When driven higher than the 1.75 V threshold, the charger is disabled. The BATDET pin is internally pulled up by a 4.0 μ A current source. The BATDET input does not affect the PPR signal.

THERMAL CURRENT FOLDBACK

An internal thermal feedback loop begins to reduce the charge current when the die temperature reaches 110°C, to prevent further temperature rise. This feature protects the 34676 from over-temperature failure, and allows the user to push the limits of the power handling capability of a given circuit board, without the risk of damaging the 34676. The charge current can be set according to the typical (not the worst case) ambient temperature, with the assurance that the charger will automatically reduce the current in worst-case conditions.

LIVE SWITCHING BETWEEN CHARGERS

When switching from one charger to the other in the middle of a charge cycle, the newly turned on charger will start a new charge cycle. When both the AC and the USB inputs are powered, switching the USBEN signal from low to high will force the charging to switch from the AC charger to the USB charger, and switching the USBEN signal from high to low will force the charging to switch from the USB charger to the AC charger. Every time when the switching happens, a new charge cycle will be initialized.

REGULATED OUTPUT

The 34676 has one regulated output, USBOUT.

The USBOUT is powered by the USB input. Its regulated output voltage is 4.85 V. When the USB input voltage is below the rising POR threshold, or higher than the OVP threshold, the USBOUT output voltage is zero volts. When the USB input voltage is above the rising POR threshold, and before the linear regulator enters regulation, the output tracks the input voltage with a possible dropout voltage, caused by the on resistance of the pass switch. When the input voltage is higher than the 4.85 V, but lower than the OVP threshold, the output is regulated to 4.85 V. The waveform of the voltage-regulated output vs. the input voltage is summarized in [Figure 39](#).

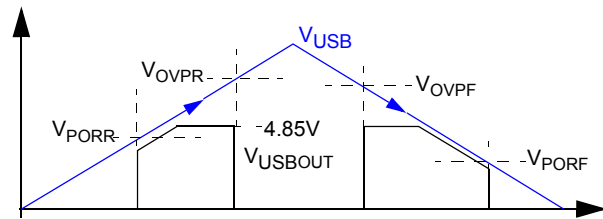

Figure 39. Voltage Regulated Output vs. Input Voltage

The regulated output is only controlled by the input voltage, and independent on the enable or the other inputs. When the USB input is powered, the USBOUT will output 4.85 V.

STATE DIAGRAM

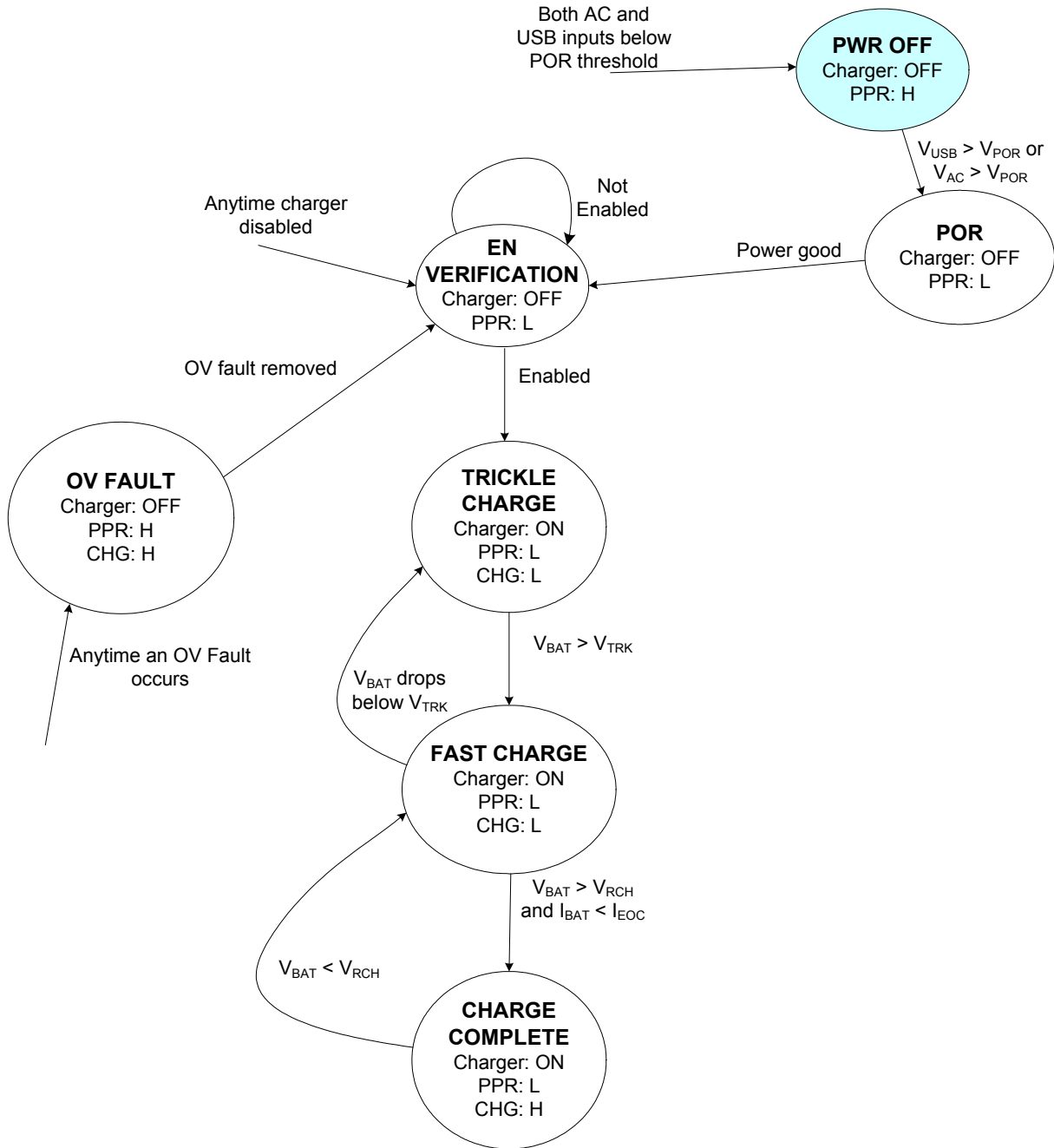

Figure 40. Charge Cycle State Diagram

ARCHIVE INFORMATION

ARCHIVE INFORMATION

TYPICAL APPLICATIONS

APPLICATION INFORMATION

INPUT CAPACITOR

The input capacitor is used to minimize the input voltage transient that may cause instability when the input voltage is near $V_{BAT} + V_{OS}$. Typically a 1.0 μF X5R ceramic capacitor is sufficient for most applications.

OUTPUT CAPACITOR

For stable operation, an X5R ceramic capacitor of 1.0 μF minimum value is needed in parallel with the battery. Depending on the load transient current, a larger capacitance may be required.

CC-MODE CURRENT SETTING

The CC-mode current of the USB charger, or the AC charger, can be set by external resistors, R_{IUSB} and R_{ISET} . A 1% accuracy resistor is recommended to guarantee 5% and 15% CC-mode current accuracy for the AC charger and the USB charger respectively.

EOC CURRENT SETTING

The EOC current can be set by the external resistor, R_{IMIN} . A 1% accuracy resistor is recommended to guarantee the EOC current accuracy.

DROPOUT VOLTAGE

If the input voltage is too low, it may not maintain the programmed CC-mode current, due to the voltage dropout over the power MOSFET. The worst case of $R_{DS(ON)}$ is 500 m Ω for the AC charger and 1000 m Ω for the USB charger. The input voltage should be higher than $V_{BAT} + I_{AC} \times 500 \text{ m}\Omega$ for the AC charger, and $V_{BAT} + I_{USB} \times 1000 \text{ m}\Omega$ for the USB charger, to guarantee the programmed CC-mode current.

THERMAL CONSIDERATIONS

The 34676 is available in a 3x3 thermally-enhanced UDFN package. A careful thermal design must be considered. The thermal pad needs to be well soldered to a large copper ground plane on the component layer. If the component layer is space limited and does not allow a large copper plane, the thermal pad needs to be connected to other layers through a via array. This increases the actual charge current capability of the 34676.

DUAL-INPUT CHARGER

Figure 41 shows a typical application using the 34676. C1 and C2 are typically 1.0 μF /X5R/16 V ceramic capacitors. C3 is a typically a 0.1 μF /X5R/6.3 V ceramic capacitor. C4 usually is a combination of multiple capacitors that are connected to the BAT bus. The charger will be stable with a minimum of a 1.0 μF /X5R/6.3 V ceramic capacitor when a battery is connected. When no battery is connected, a minimum of a 10 mA load current is required for the charger output to be stable in CV phase. All connections to the MCU are optional. The voltage output of the ISET and the IUSB pin can be monitored by an analog-to-digital input of the MCU, for charge current measurement. The USBEN pin requires no pull-up resistors.

The MCU can choose the AC charger or the USB charger, by controlling the USBEN pin voltage. Since the BATDET sources 6.0 μA (maximum) of current and has a 1.65 V (minimum) battery detection threshold, a pull-down resistor less than 275 k Ω should be attached at BATDET, to enable the charger. If the battery pack doesn't have an ID resistor inside, an external resistor is required.

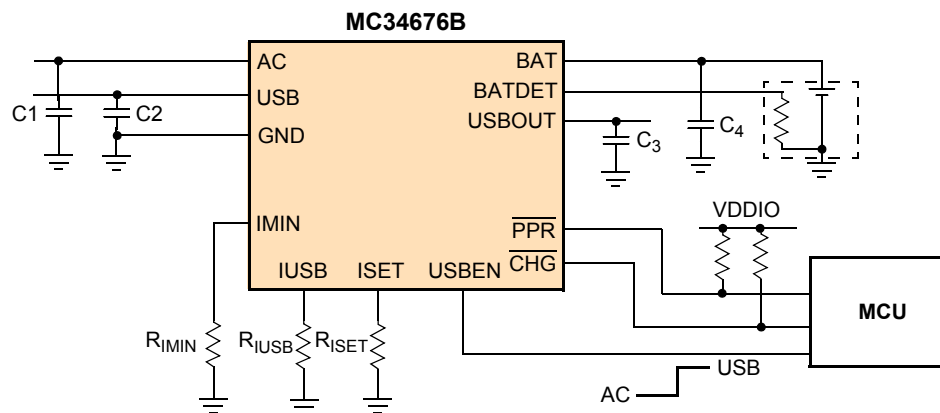
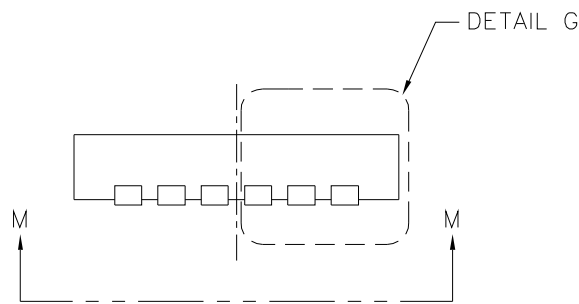
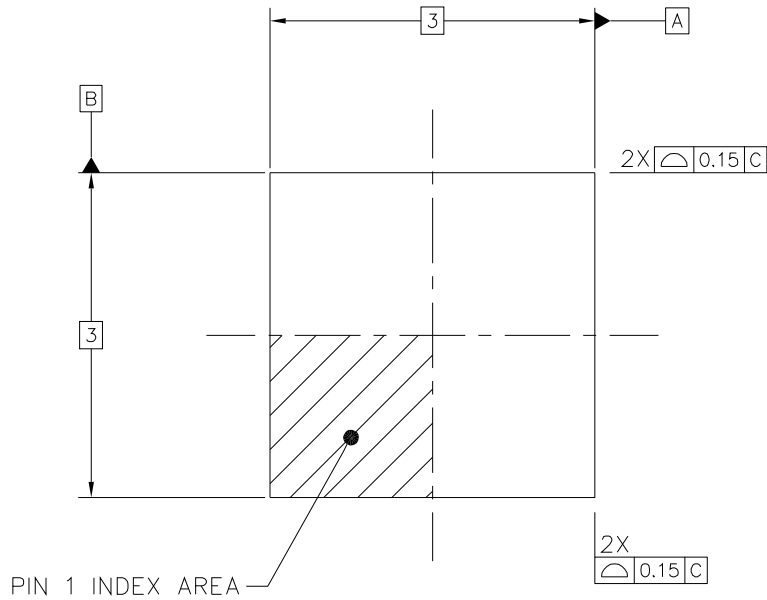

Figure 41. Dual-input Charger of the MC34676

PACKAGE DIMENSIONS

For the most current package revision, visit www.freescale.com and perform a keyword search using the “98A” listed below.



© FREESCALE SEMICONDUCTOR, INC. ALL RIGHTS RESERVED.	MECHANICAL OUTLINE	PRINT VERSION NOT TO SCALE	
TITLE: THERMALLY ENHANCED QUAD FLAT NON-LEADED PACKAGE (QFN) 12 TERMINAL, 0.4 PITCH (3 X 3 X 0.6)	DOCUMENT NO: 98ASA10814D	REV: 0	
	CASE NUMBER: 1996-01	18 JAN 2008	
	STANDARD: NON-JEDEC		

EP SUFFIX
12-PIN
98ASA10814D
REVISION 0

ARCHIVE INFORMATION

ARCHIVE INFORMATION

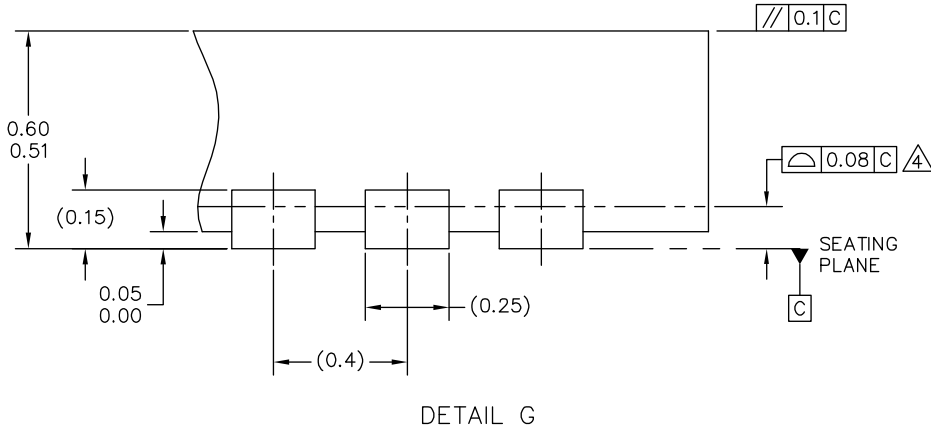
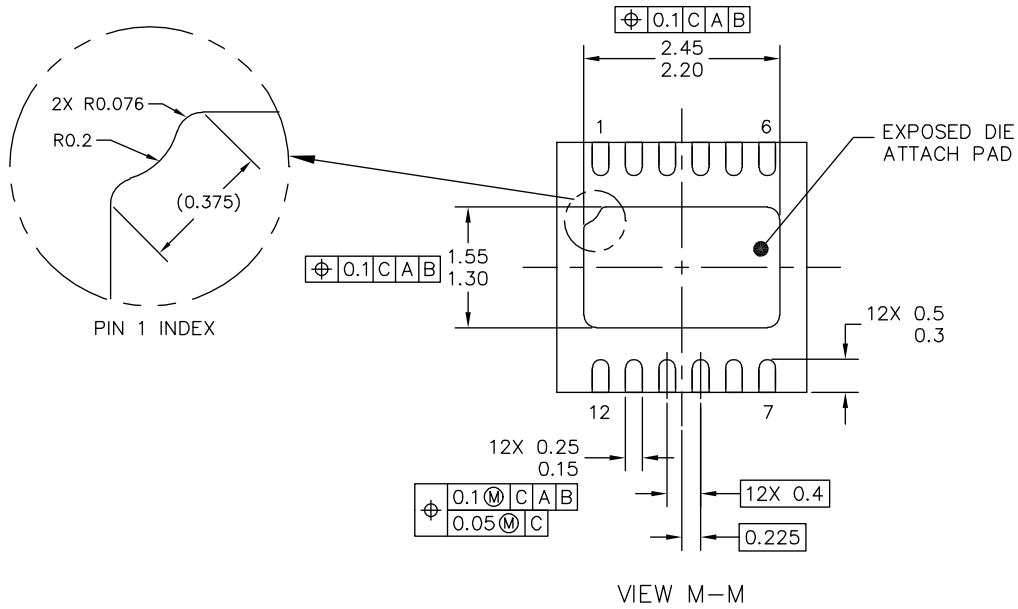

© FREESCALE SEMICONDUCTOR, INC. ALL RIGHTS RESERVED.	MECHANICAL OUTLINE	PRINT VERSION NOT TO SCALE	
TITLE: THERMALLY ENHANCED QUAD FLAT NON-LEADED PACKAGE (QFN) 12 TERMINAL, 0.4 PITCH (3 X 3 X 0.6)	DOCUMENT NO: 98ASA10814D	REV: 0	
	CASE NUMBER: 1996-01	18 JAN 2008	
	STANDARD: NON-JEDEC		

EP SUFFIX
 12-PIN
 98ASA10814D
 REVISION 0

NOTES:

1. ALL DIMENSIONS ARE IN MILLIMETERS.
2. DIMENSIONING AND TOLERANCING PER ASME Y14.5M-1994.
3. THE COMPLETE JEDEC DESIGNATOR FOR THIS PACKAGE IS: HF-PQFN.
4.  COPLANARITY APPLIES TO LEADS AND DIE ATTACH PAD.
5. MIN. METAL GAP SHOULD BE 0.2 MM.

ARCHIVE INFORMATION

ARCHIVE INFORMATION

© FREESCALE SEMICONDUCTOR, INC. ALL RIGHTS RESERVED.	MECHANICAL OUTLINE	PRINT VERSION NOT TO SCALE	
TITLE: THERMALLY ENHANCED QUAD FLAT NON-LEADED PACKAGE (QFN) 12 TERMINAL, 0.4 PITCH (3 X 3 X 0.6)	DOCUMENT NO: 98ASA10814D	REV: 0	
	CASE NUMBER: 1996-01	18 JAN 2008	
	STANDARD: NON-JEDEC		

EP SUFFIX
12-PIN
98ASA10814D
REVISION 0

REVISION HISTORY

REVISION	DATE	DESCRIPTION OF CHANGES
1.0	10/2007	<ul style="list-style-type: none">Initial Release

ARCHIVE INFORMATION

ARCHIVE INFORMATION

How to Reach Us:

Home Page:

www.freescale.com

Web Support:

<http://www.freescale.com/support>

USA/Europe or Locations Not Listed:

Freescale Semiconductor, Inc.
Technical Information Center, EL516
2100 East Elliot Road
Tempe, Arizona 85284
+1-800-521-6274 or +1-480-768-2130
www.freescale.com/support

Europe, Middle East, and Africa:

Freescale Halbleiter Deutschland GmbH
Technical Information Center
Schatzbogen 7
81829 Muenchen, Germany
+44 1296 380 456 (English)
+46 8 52200080 (English)
+49 89 92103 559 (German)
+33 1 69 35 48 48 (French)
www.freescale.com/support

Japan:

Freescale Semiconductor Japan Ltd.
Headquarters
ARCO Tower 15F
1-8-1, Shimo-Meguro, Meguro-ku,
Tokyo 153-0064
Japan
0120 191014 or +81 3 5437 9125
support.japan@freescale.com

Asia/Pacific:

Freescale Semiconductor China Ltd.
Exchange Building 23F
No. 118 Jianguo Road
Chaoyang District
Beijing 100022
China
+86 10 5879 8000
support.asia@freescale.com

For Literature Requests Only:

Freescale Semiconductor Literature Distribution Center
P.O. Box 5405
Denver, Colorado 80217
1-800-441-2447 or 303-675-2140
Fax: 303-675-2150
LDCForFreescaleSemiconductor@hibbertgroup.com

Information in this document is provided solely to enable system and software implementers to use Freescale Semiconductor products. There are no express or implied copyright licenses granted hereunder to design or fabricate any integrated circuits or integrated circuits based on the information in this document.

Freescale Semiconductor reserves the right to make changes without further notice to any products herein. Freescale Semiconductor makes no warranty, representation or guarantee regarding the suitability of its products for any particular purpose, nor does Freescale Semiconductor assume any liability arising out of the application or use of any product or circuit, and specifically disclaims any and all liability, including without limitation consequential or incidental damages. "Typical" parameters that may be provided in Freescale Semiconductor data sheets and/or specifications can and do vary in different applications and actual performance may vary over time. All operating parameters, including "Typicals", must be validated for each customer application by customer's technical experts. Freescale Semiconductor does not convey any license under its patent rights nor the rights of others. Freescale Semiconductor products are not designed, intended, or authorized for use as components in systems intended for surgical implant into the body, or other applications intended to support or sustain life, or for any other application in which the failure of the Freescale Semiconductor product could create a situation where personal injury or death may occur. Should Buyer purchase or use Freescale Semiconductor products for any such unintended or unauthorized application, Buyer shall indemnify and hold Freescale Semiconductor and its officers, employees, subsidiaries, affiliates, and distributors harmless against all claims, costs, damages, and expenses, and reasonable attorney fees arising out of, directly or indirectly, any claim of personal injury or death associated with such unintended or unauthorized use, even if such claim alleges that Freescale Semiconductor was negligent regarding the design or manufacture of the part.

Freescale™ and the Freescale logo are trademarks of Freescale Semiconductor, Inc. All other product or service names are the property of their respective owners.

© Freescale Semiconductor, Inc., 2008. All rights reserved.

X-ON Electronics

Largest Supplier of Electrical and Electronic Components

Click to view similar products for [Battery Management](#) category:

Click to view products by [Freescale](#) manufacturer:

Other Similar products are found below :

[MP2602DQ-LF-P](#) [MP26053DQ-LF-Z](#) [MP2611GL-P](#) [NCP347MTAHTBG](#) [LM3658SD-AEV/NOPB](#) [MP2607DL-LF-P](#) [MP26121DQ-LF-P](#)
[MP26123DR-LF-P](#) [MP2633GR-P](#) [MP2637GR-P](#) [BQ24212EVM-678](#) [NCP1855FCCT1G](#) [MP2636GR-P](#) [FAN54063UCX](#)
[MAX14680EWC+T](#) [MAX14634EWC+T](#) [DS2745U+T&R](#) [MAX14578EETE+T](#) [DS2781EVKIT+](#) [DS2781E+T&R](#) [MP2605DQ-LF-P](#)
[DS2710G+T&R](#) [MAX17040G+T](#) [MAX14525ETA+T](#) [MP2615GQ-P](#) [MAX14578EEWC+T](#) [LC05132C01NMTTTG](#) [MAX8971EWP+T](#)
[MAX14630EZK+T](#) [MAX1873TEEE+T](#) [PSC5415A](#) [AUR9811DGD](#) [SN2040DSQR](#) [DS2715BZ+T&R](#) [MAX1508ZETA+T](#)
[MAX14921ECS+T](#) [MAX77301EWA+T](#) [BD8668GW-E2](#) [MAX16024PTBS+T](#) [DS2715Z+T&R](#) [MAX16024LTBZ18+T](#) [DS2782E+T&R](#)
[DS2782G+T&R](#) [MAX1908ETI+T](#) [ISL95522IRZ](#) [ISL95522HRZ](#) [ARD00558](#) [NCP4371AAEDR2G](#) [BD8665GW-E2](#) [MAX8934EETI+T](#)