



RF Power Field Effect Transistors

N-Channel Enhancement-Mode Lateral MOSFETs

Designed for CDMA and multicarrier base station applications with frequencies from 1805 to 1880 MHz. Can be used in Class AB and Class C for all typical cellular base station modulation formats.

- Typical Single-Carrier W-CDMA Performance: $V_{DD} = 30$ Volts, $I_{DQ} = 1600$ mA, $P_{out} = 74$ Watts Avg., IQ Magnitude Clipping, Channel Bandwidth = 3.84 MHz, Input Signal PAR = 7.5 dB @ 0.01% Probability on CCDF.

Frequency	G_{ps} (dB)	η_D (%)	Output PAR (dB)	ACPR (dBc)
1805 MHz	17.9	31.6	6.0	-35.0
1840 MHz	17.9	31.9	6.0	-36.0
1880 MHz	17.9	32.5	5.9	-36.0

- Capable of Handling 10:1 VSWR, @ 32 Vdc, 1840 MHz, 374 Watts CW Output Power (3 dB Input Overdrive from Rated P_{out})
- Typical P_{out} @ 1 dB Compression Point \approx 260 Watts CW

Features

- 100% PAR Tested for Guaranteed Output Power Capability
- Characterized with Series Equivalent Large-Signal Impedance Parameters and Common Source S-Parameters
- Internally Matched for Ease of Use
- Integrated ESD Protection
- Greater Negative Gate-Source Voltage Range for Improved Class C Operation
- Designed for Digital Predistortion Error Correction Systems
- Optimized for Doherty Applications
- In Tape and Reel. R6 Suffix = 150 Units per 56 mm, 13 inch Reel.

Table 1. Maximum Ratings

Rating	Symbol	Value	Unit
Drain-Source Voltage	V_{DSS}	-0.5, +65	Vdc
Gate-Source Voltage	V_{GS}	-6.0, +10	Vdc
Operating Voltage	V_{DD}	32, +0	Vdc
Storage Temperature Range	T_{stg}	-65 to +150	°C
Case Operating Temperature	T_C	150	°C
Operating Junction Temperature (1,2)	T_J	225	°C
CW Operation @ $T_C = 25^\circ\text{C}$ Derate above 25°C	CW	420 3.5	W W/°C

Table 2. Thermal Characteristics

Characteristic	Symbol	Value (2,3)	Unit
Thermal Resistance, Junction to Case Case Temperature 81°C, 74 W CW, 30 Vdc, $I_{DQ} = 1600$ mA, 1805 MHz Case Temperature 88°C, 260 W CW(4), 30 Vdc, $I_{DQ} = 1600$ mA, 1805 MHz	$R_{\theta JC}$	0.27 0.26	°C/W

1. Continuous use at maximum temperature will affect MTTF.
2. MTTF calculator available at <http://www.freescale.com/rf>. Select Software & Tools/Development Tools/Calculators to access MTTF calculators by product.
3. Refer to AN1955, *Thermal Measurement Methodology of RF Power Amplifiers*. Go to <http://www.freescale.com/rf>. Select Documentation/Application Notes - AN1955.
4. Exceeds recommended operating conditions. See CW operation data in Maximum Ratings table.

MRF8S18260HR6
MRF8S18260HSR6

1805-1880 MHz, 74 W AVG., 30 V
SINGLE W-CDMA
LATERAL N-CHANNEL
RF POWER MOSFETs

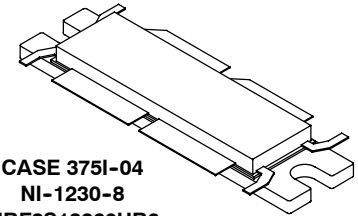

CASE 375I-04
NI-1230-8
MRF8S18260HR6

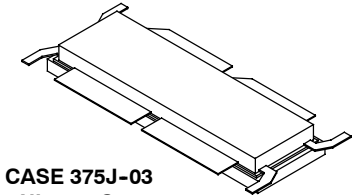

CASE 375J-03
NI-1230S-8
MRF8S18260HSR6

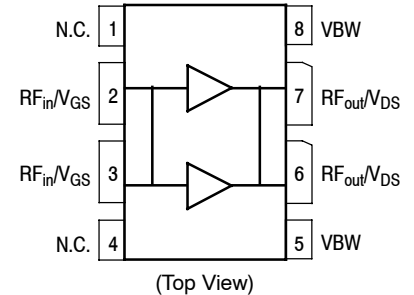

Figure 1. Pin Connections

Table 3. ESD Protection Characteristics

Test Methodology	Class
Human Body Model (per JESD22-A114)	2
Machine Model (per EIA/JESD22-A115)	A
Charge Device Model (per JESD22-C101)	IV

Table 4. Electrical Characteristics ($T_A = 25^\circ\text{C}$ unless otherwise noted)

Characteristic	Symbol	Min	Typ	Max	Unit
----------------	--------	-----	-----	-----	------

Off Characteristics ⁽¹⁾

Zero Gate Voltage Drain Leakage Current ($V_{DS} = 65\text{ Vdc}$, $V_{GS} = 0\text{ Vdc}$)	I_{DSS}	—	—	10	μAdc
Zero Gate Voltage Drain Leakage Current ($V_{DS} = 28\text{ Vdc}$, $V_{GS} = 0\text{ Vdc}$)	I_{DSS}	—	—	1	μAdc
Gate-Source Leakage Current ($V_{GS} = 5\text{ Vdc}$, $V_{DS} = 0\text{ Vdc}$)	I_{GSS}	—	—	1	μAdc

On Characteristics ⁽¹⁾

Gate Threshold Voltage ($V_{DS} = 10\text{ Vdc}$, $I_D = 400\ \mu\text{Adc}$)	$V_{GS(th)}$	1.1	1.9	2.6	Vdc
Gate Quiescent Voltage ($V_{DS} = 30\text{ Vdc}$, $I_D = 1600\text{ mA}$)	$V_{GS(Q)}$	—	2.6	—	Vdc
Fixture Gate Quiescent Voltage ($V_{DD} = 30\text{ Vdc}$, $I_D = 1600\text{ mA}$, Measured in Functional Test)	$V_{GG(Q)}$	4.3	5.1	5.8	Vdc
Drain-Source On-Voltage ($V_{GS} = 10\text{ Vdc}$, $I_D = 4\text{ Adc}$)	$V_{DS(on)}$	0.1	0.15	0.3	Vdc

Functional Tests ^(1,2) (In Freescale Test Fixture, 50 ohm system) $V_{DD} = 30\text{ Vdc}$, $I_{DQ} = 1600\text{ mA}$, $P_{out} = 74\text{ W Avg.}$, $f = 1805\text{ MHz}$, Single-Carrier W-CDMA, IQ Magnitude Clipping, Input Signal PAR = 7.5 dB @ 0.01% Probability on CCDF. ACPR measured in 3.84 MHz Channel Bandwidth @ $\pm 5\text{ MHz}$ Offset.

Power Gain	G_{ps}	16.8	17.9	19.0	dB
Drain Efficiency	η_D	29.0	31.6	—	%
Output Peak-to-Average Ratio @ 0.01% Probability on CCDF	PAR	5.4	6.0	—	dB
Adjacent Channel Power Ratio	ACPR	—	-35.0	-32.0	dBc
Input Return Loss	IRL	—	-19	-7	dB

Typical Broadband Performance (In Freescale Test Fixture, 50 ohm system) $V_{DD} = 30\text{ Vdc}$, $I_{DQ} = 1600\text{ mA}$, $P_{out} = 74\text{ W Avg.}$, Single-Carrier W-CDMA, IQ Magnitude Clipping, Input Signal PAR = 7.5 dB @ 0.01% Probability on CCDF. ACPR measured in 3.84 MHz Channel Bandwidth @ $\pm 5\text{ MHz}$ Offset.

Frequency	G_{ps} (dB)	η_D (%)	Output PAR (dB)	ACPR (dBc)	IRL (dB)
1805 MHz	17.9	31.6	6.0	-35.0	-19
1840 MHz	17.9	31.9	6.0	-36.0	-18
1880 MHz	17.9	32.5	5.9	-36.0	-8

1. Gates (Pins 2, 3) and drains (Pins 6, 7) are connected internally.
2. Part internally matched both on input and output.

(continued)

Table 4. Electrical Characteristics ($T_A = 25^\circ\text{C}$ unless otherwise noted) (continued)

Characteristic	Symbol	Min	Typ	Max	Unit
Typical Performances (In Freescale Test Fixture, 50 ohm system) $V_{DD} = 30\text{ Vdc}$, $I_{DQ} = 1600\text{ mA}$, 1805–1880 MHz Bandwidth					
P_{out} @ 1 dB Compression Point, CW	P1dB	—	260	—	W
IMD Symmetry @ 100 W PEP, P_{out} where IMD Third Order Intermodulation $\cong 30\text{ dBc}$ (Delta IMD Third Order Intermodulation between Upper and Lower Sidebands $> 2\text{ dB}$)	IMD _{sym}	—	21	—	MHz
VBW Resonance Point (IMD Third Order Intermodulation Inflection Point)	VBW _{res}	—	64	—	MHz
Gain Flatness in 75 MHz Bandwidth @ $P_{out} = 74\text{ W Avg.}$	G _F	—	0.4	—	dB
Gain Variation over Temperature (-30°C to $+85^\circ\text{C}$)	ΔG	—	0.011	—	dB/ $^\circ\text{C}$
Output Power Variation over Temperature (-30°C to $+85^\circ\text{C}$) (1)	ΔP_{1dB}	—	0.01	—	dB/ $^\circ\text{C}$

1. Exceeds recommended operating conditions. See CW operation data in Maximum Ratings table.

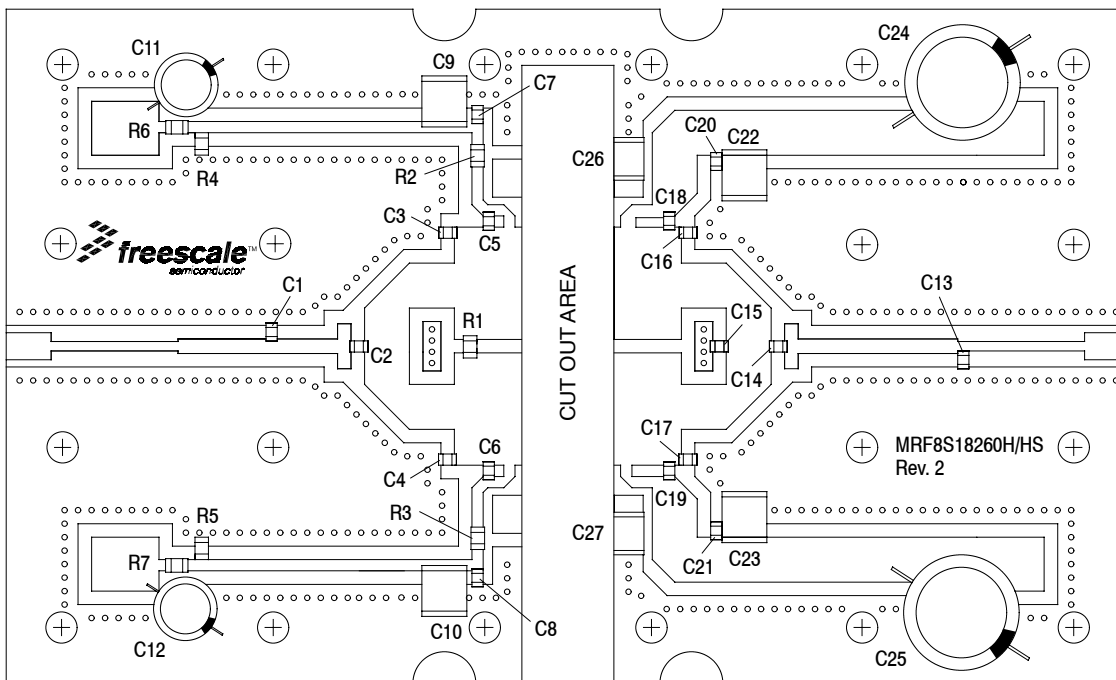

Figure 2. MRF8S18260HR6(HSR6) Test Circuit Component Layout

Table 5. MRF8S18260HR6(HSR6) Test Circuit Component Designations and Values

Part	Description	Part Number	Manufacturer
C1	2.2 pF Chip Capacitor	ATC600F2R2BT250XT	ATC
C2, C7, C8, C14, C20, C21	15 pF Chip Capacitors	ATC600F150JT250XT	ATC
C3, C4, C5, C6, C16, C17, C18, C19	1.0 pF Chip Capacitors	ATC600F1R0BT250XT	ATC
C9, C10, C22, C23	10 μ F, 50 V Chip Capacitors	GRM55DR61H106KA88L	Murata
C11, C12	47 μ F, 35 V Electrolytic Capacitors	476KXM050M	Illinois Capacitor
C13	0.6 pF Chip Capacitor	ATC600F0R6BT250XT	ATC
C15	0.4 pF Chip Capacitor	ATC600F0R4BT250XT	ATC
C24, C25	470 μ F, 63 V Electrolytic Capacitors	MCGPR63V477M13X26-RH	Multicomp
C26, C27	6.8 μ F Chip Capacitors	C4532X7RIH685K	TDK
R1	2 k Ω , 1/4 W Chip Resistor	CRCW12062k00FKEA	Vishay
R2, R3	4.75 Ω , 1/4 W Chip Resistors	CRCW12064R75FKEA	Vishay
R4, R5, R6, R7	1 k Ω , 1/4 W Chip Resistors	CRCW12061K00FKEA	Vishay
PCB	0.020", $\epsilon_r = 3.5$	RO4350B	Rogers

TYPICAL CHARACTERISTICS

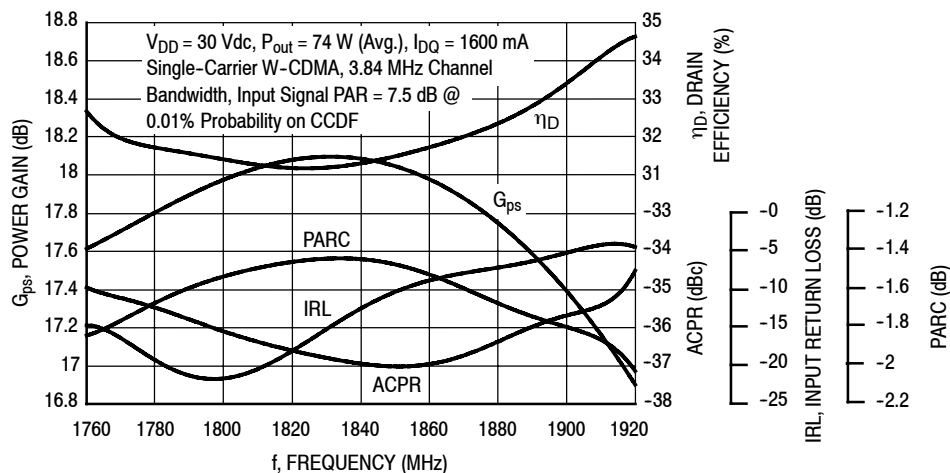

Figure 3. Output Peak-to-Average Ratio Compression (PARC) Broadband Performance @ $P_{out} = 74$ Watts Avg.

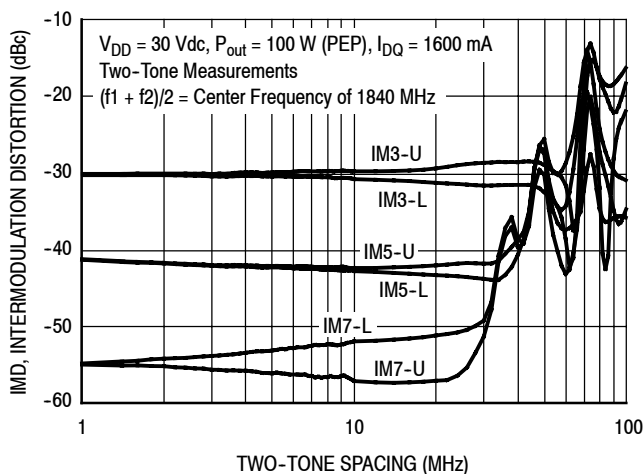

Figure 4. Intermodulation Distortion Products versus Two-Tone Spacing

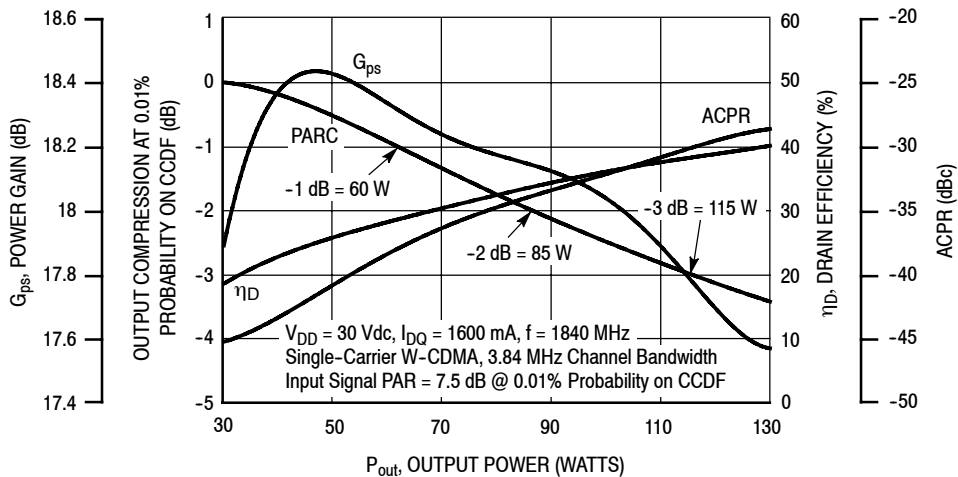

Figure 5. Output Peak-to-Average Ratio Compression (PARC) versus Output Power

TYPICAL CHARACTERISTICS

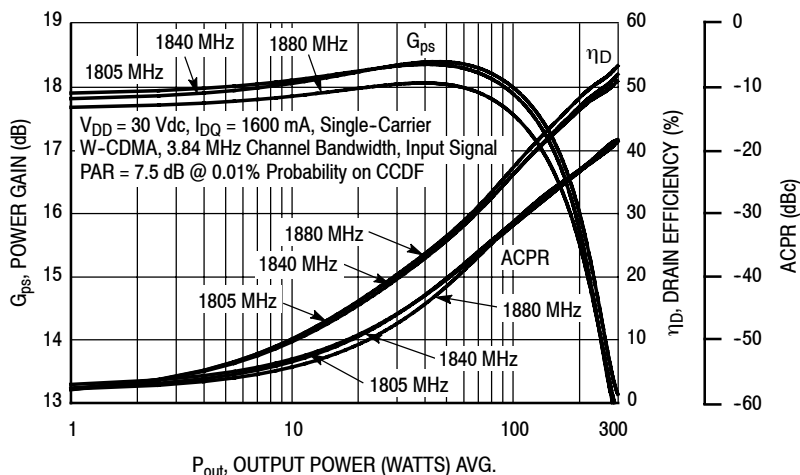

Figure 6. Single-Carrier W-CDMA Power Gain, Drain Efficiency and ACPR versus Output Power

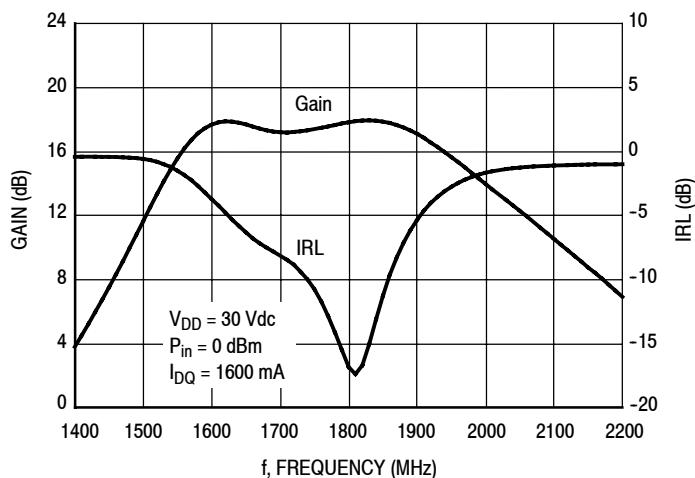

Figure 7. Broadband Frequency Response

W-CDMA TEST SIGNAL

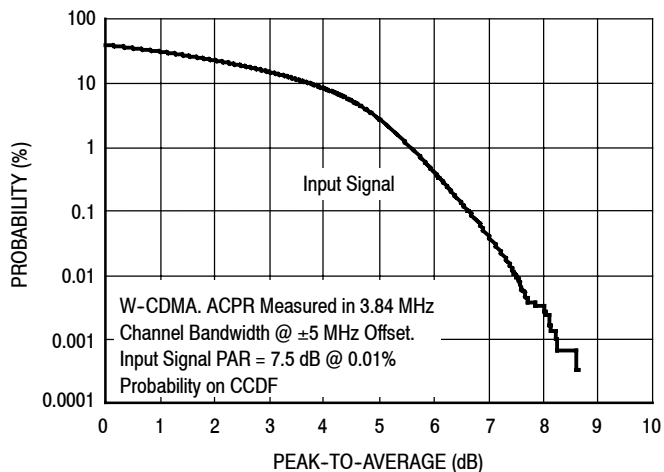

Figure 8. CCDF W-CDMA IQ Magnitude Clipping, Single-Carrier Test Signal

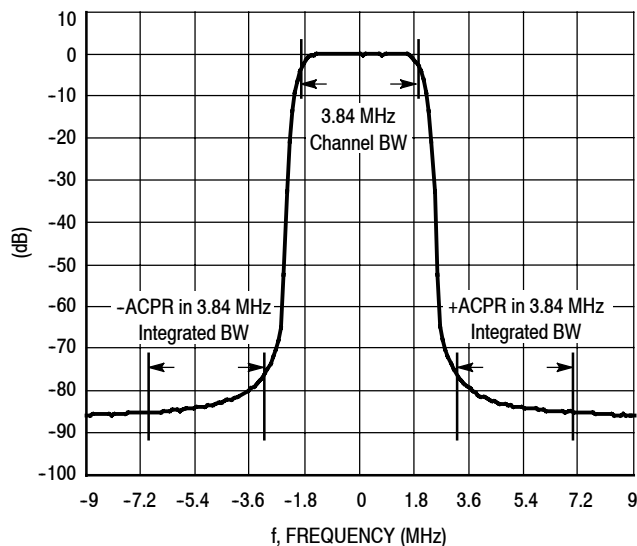

Figure 9. Single-Carrier W-CDMA Spectrum

$V_{DD} = 30 \text{ Vdc}$, $I_{DQ} = 1600 \text{ mA}$, $P_{out} = 74 \text{ W Avg.}$

f MHz	Z_{source} Ω	Z_{load} Ω
1760	2.81 - j3.85	0.90 - j1.84
1780	2.58 - j3.93	0.90 - j1.75
1800	2.33 - j3.97	0.90 - j1.67
1820	2.08 - j3.95	0.90 - j1.58
1840	1.85 - j3.91	0.90 - j1.50
1860	1.63 - j3.83	0.91 - j1.41
1880	1.43 - j3.73	0.91 - j1.34
1900	1.25 - j3.61	0.92 - j1.26
1920	1.09 - j3.48	0.93 - j1.18

Z_{source} = Test circuit impedance as measured from gate to ground.

Z_{load} = Test circuit impedance as measured from drain to ground.

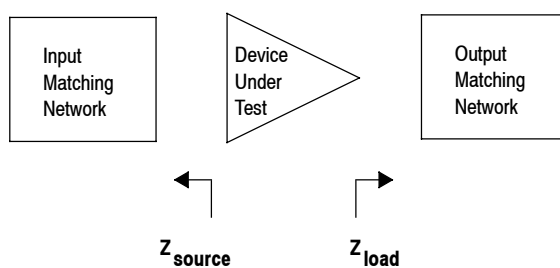
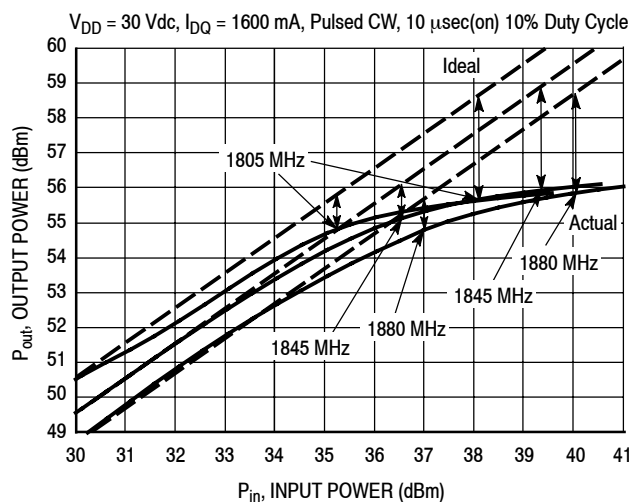

Figure 10. Series Equivalent Source and Load Impedance

ALTERNATIVE PEAK TUNE LOAD PULL CHARACTERISTICS



f (MHz)	P1dB		P3dB	
	Watts	dBm	Watts	dBm
1805	302	54.8	363	55.6
1845	324	55.1	389	55.9
1880	302	54.8	389	55.9

Test Impedances per Compression Level

f (MHz)		Z_{source} Ω	Z_{load} Ω
1805	P1dB	$1.14 - j3.12$	$0.75 - j0.93$
1845	P1dB	$1.61 - j3.61$	$0.58 - j0.10$
1880	P1dB	$2.93 - j3.80$	$0.51 - j1.14$

Figure 11. Pulsed CW Output Power versus Input Power @ 30 V

PACKAGE DIMENSIONS

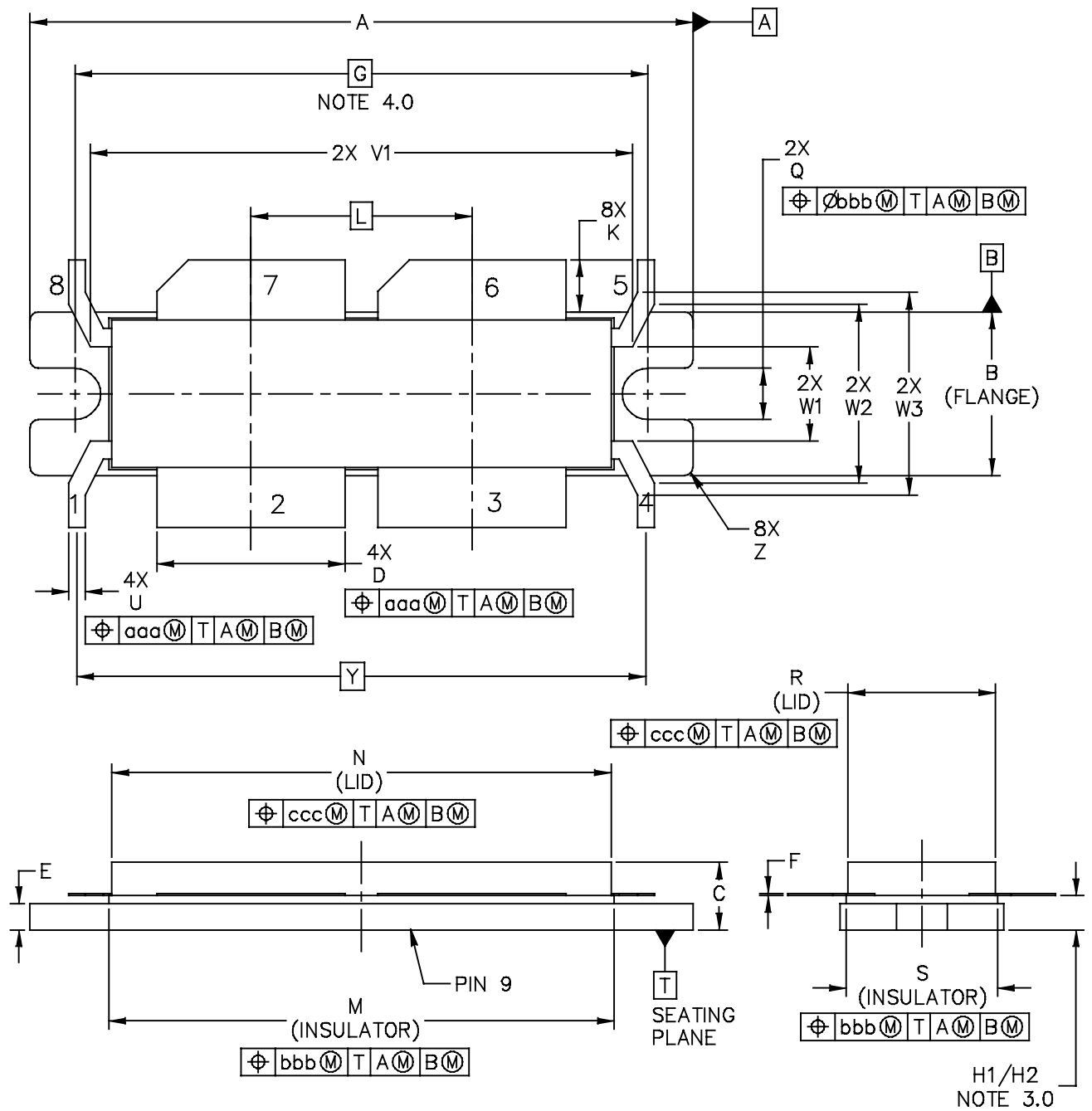

© FREESCALE SEMICONDUCTOR, INC. ALL RIGHTS RESERVED.	MECHANICAL OUTLINE		PRINT VERSION NOT TO SCALE	
	TITLE: NI-1230-8		DOCUMENT NO: 98ASA00120D CASE NUMBER: 375I-04 STANDARD: NON-JEDEC	REV: C 18 JUL 2011

MRF8S18260HR6 MRF8S18260HSR6

NOTES:

1.0 INTERPRET DIMENSIONS AND TOLERANCES PER ASME Y14.5M-1994.

2.0 CONTROLLING DIMENSION: INCH

3.0 DIMENSION H1 AND H2 ARE MEASURED .030 (0.762) AWAY FROM PACKAGE BODY.
H1 APPLIES TO PINS 2,3,6,7. H2 APPLIES TO PINS 1,4,5,8.

4.0 RECOMMENDED BOLT CENTER DIMENSION OF 1.52 (38.61) BASED ON M3 SCREW.

DIM	INCH		MILLIMETER		DIM	INCH		MILLIMETER	
	MIN	MAX	MIN	MAX		MIN	MAX	MIN	MAX
A	1.615	1.625	41.02	41.28	N	1.218	1.242	30.94	31.55
B	.395	.405	10.03	10.29	Q	.120	.130	3.05	3.3
C	.150	.200	3.81	5.08	R	.365	.375	9.27	9.53
D	.455	.465	11.56	11.81	S	.365	.375	9.27	9.53
E	.062	.066	1.57	1.68	V1	1.320	1.330	33.53	33.78
F	.004	.007	0.10	0.18	U	.035	.045	0.89	1.14
G	1.400 BSC		35.56 BSC		W1	.225	.235	5.72	5.97
H1	.082	.090	2.08	2.29	W2	.431	.441	10.95	11.20
H2	.078	.094	1.98	2.39	W3	.491	.501	12.47	12.73
K	.117	.137	2.97	3.48	Y	1.390 BSC		35.31 BSC	
L	.540 BSC		13.72 BSC		Z	---	R.020	---	R0.51
M	1.219	1.241	30.96	31.52	aaa	.013		0.33	
					bbb	.010		0.25	
					ccc	.020		0.51	
© FREESCALE SEMICONDUCTOR, INC. ALL RIGHTS RESERVED.			MECHANICAL OUTLINE			PRINT VERSION NOT TO SCALE			
TITLE: NI-1230-8					DOCUMENT NO: 98ASA00120D			REV: C	
					CASE NUMBER: 375I-04			18 JUL 2011	
					STANDARD: NON-JEDEC				

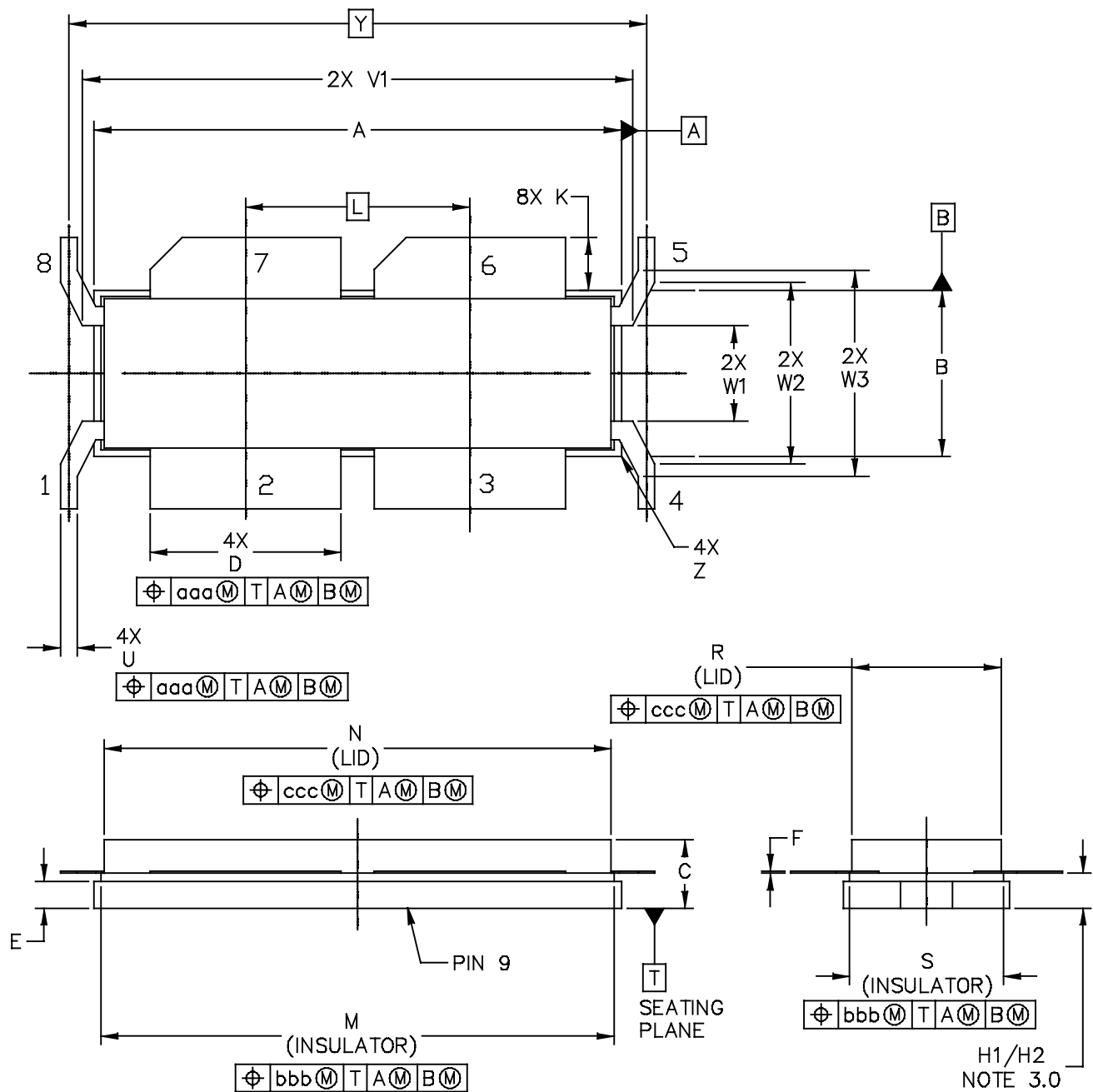

© FREESCALE SEMICONDUCTOR, INC. ALL RIGHTS RESERVED.		MECHANICAL OUTLINE	PRINT VERSION NOT TO SCALE
TITLE: NI-1230S-8	DOCUMENT NO: 98ASA00155D		REV: B
	CASE NUMBER: 375J-03		18 JUL 2011
	STANDARD: NON-JEDEC		

NOTES:

1.0 INTERPRET DIMENSIONS AND TOLERANCES PER ASME Y14.5M-1994.

2.0 CONTROLLING DIMENSION: INCH

3.0 DIMENSION H1 AND H2 ARE MEASURED .030 (0.762) AWAY FROM PACKAGE BODY.
H1 APPLIES TO PINS 2,3,6,7. H2 APPLIES TO PINS 1,4,5,8.

4.0 -DELETED-

DIM	INCH		MILLIMETER		DIM	INCH		MILLIMETER	
	MIN	MAX	MIN	MAX		MIN	MAX	MIN	MAX
A	1.265	1.275	32.13	32.39	N	1.218	1.242	30.94	31.55
B	.395	.405	10.03	10.29	R	.365	.375	9.27	9.53
C	.150	.200	3.81	5.08	S	.365	.375	9.27	9.53
D	.455	.465	11.56	11.81	U	.035	.045	0.89	1.14
E	.062	.066	1.57	1.68	V1	1.320	1.330	33.53	33.78
F	.004	.007	0.10	0.18	T3	DELETED		DELETED	
H1	.082	.090	2.08	2.29	W1	.225	.235	5.72	5.97
H2	.078	.094	1.98	2.39	W2	.431	.441	10.95	10.20
K	.117	.137	2.97	3.48	W3	.491	.501	12.47	12.73
L	.540 BSC		13.72 BSC		Y	1.390 BSC		35.31 BSC	
M	1.219	1.241	30.96	31.52	Z	---	R.040	---	R1.02
					aaa	.005		0.13	
					bbb	.010		0.25	
					ccc	.020		0.51	
© FREESCALE SEMICONDUCTOR, INC. ALL RIGHTS RESERVED.			MECHANICAL OUTLINE			PRINT VERSION NOT TO SCALE			
TITLE: NI-1230S-8					DOCUMENT NO: 98ASA00155D			REV: B	
					CASE NUMBER: 375J-03			18 JUL 2011	
					STANDARD: NON-JEDEC				

PRODUCT DOCUMENTATION AND SOFTWARE

Refer to the following documents and software to aid your design process.

Application Notes

- AN1955: Thermal Measurement Methodology of RF Power Amplifiers

Engineering Bulletins

- EB212: Using Data Sheet Impedances for RF LDMOS Devices

Software

- Electromigration MTTF Calculator
- RF High Power Model
- .s2p File

For Software, do a Part Number search at <http://www.freescale.com>, and select the "Part Number" link. Go to the Software & Tools tab on the part's Product Summary page to download the respective tool.

REVISION HISTORY

The following table summarizes revisions to this document.

Revision	Date	Description
0	Sept. 2010	<ul style="list-style-type: none">• Initial Release of Data Sheet
1	Feb. 2012	<ul style="list-style-type: none">• Table 3, ESD Protection Characteristics, removed the word "Minimum" after the ESD class rating. ESD ratings are characterized during new product development but are not 100% tested during production. ESD ratings provided in the data sheet are intended to be used as a guideline when handling ESD sensitive devices, p. 2• Replaced Case Outline 375I-03, Issue B with 375I-04, Issue C, p. 1, 9, 10. On Sheet 2, changed dimension F in mm from 0.1-0.18 to 0.10-0.18, changed dimension U in mm from 0.89-1.02 to 0.89-1.14, changed dimension W3 in mm from 12.47-12.72 to 12.47-12.73.• Replaced Case Outline 375J-02, Issue A with 375J-03, Issue B, p. 1, 11, 12. On Sheet 2, changed dimension A in mm from 32.13-32.38 to 32.13-32.39, changed dimension F in mm from 0.1-0.18 to 0.10-0.18, changed dimension U in mm from 8.89-11.43 to 0.89-1.14.

How to Reach Us:

Home Page:

www.freescale.com

Web Support:

<http://www.freescale.com/support>

USA/Europe or Locations Not Listed:

Freescale Semiconductor, Inc.
Technical Information Center, EL516
2100 East Elliot Road
Tempe, Arizona 85284
1-800-521-6274 or +1-480-768-2130
www.freescale.com/support

Europe, Middle East, and Africa:

Freescale Halbleiter Deutschland GmbH
Technical Information Center
Schatzbogen 7
81829 Muenchen, Germany
+44 1296 380 456 (English)
+46 8 52200080 (English)
+49 89 92103 559 (German)
+33 1 69 35 48 48 (French)
www.freescale.com/support

Japan:

Freescale Semiconductor Japan Ltd.
Headquarters
ARCO Tower 15F
1-8-1, Shimo-Meguro, Meguro-ku,
Tokyo 153-0064
Japan
0120 191014 or +81 3 5437 9125
support.japan@freescale.com

Asia/Pacific:

Freescale Semiconductor China Ltd.
Exchange Building 23F
No. 118 Jianguo Road
Chaoyang District
Beijing 100022
China
+86 10 5879 8000
support.asia@freescale.com

For Literature Requests Only:

Freescale Semiconductor Literature Distribution Center
1-800-441-2447 or +1-303-675-2140
Fax: +1-303-675-2150
LDCForFreescaleSemiconductor@hibbertgroup.com

Information in this document is provided solely to enable system and software implementers to use Freescale Semiconductor products. There are no express or implied copyright licenses granted hereunder to design or fabricate any integrated circuits or integrated circuits based on the information in this document.

Freescale Semiconductor reserves the right to make changes without further notice to any products herein. Freescale Semiconductor makes no warranty, representation or guarantee regarding the suitability of its products for any particular purpose, nor does Freescale Semiconductor assume any liability arising out of the application or use of any product or circuit, and specifically disclaims any and all liability, including without limitation consequential or incidental damages. "Typical" parameters that may be provided in Freescale Semiconductor data sheets and/or specifications can and do vary in different applications and actual performance may vary over time. All operating parameters, including "Typicals", must be validated for each customer application by customer's technical experts. Freescale Semiconductor does not convey any license under its patent rights nor the rights of others. Freescale Semiconductor products are not designed, intended, or authorized for use as components in systems intended for surgical implant into the body, or other applications intended to support or sustain life, or for any other application in which the failure of the Freescale Semiconductor product could create a situation where personal injury or death may occur. Should Buyer purchase or use Freescale Semiconductor products for any such unintended or unauthorized application, Buyer shall indemnify and hold Freescale Semiconductor and its officers, employees, subsidiaries, affiliates, and distributors harmless against all claims, costs, damages, and expenses, and reasonable attorney fees arising out of, directly or indirectly, any claim of personal injury or death associated with such unintended or unauthorized use, even if such claim alleges that Freescale Semiconductor was negligent regarding the design or manufacture of the part.

Freescale™ and the Freescale logo are trademarks of Freescale Semiconductor, Inc. All other product or service names are the property of their respective owners.

© Freescale Semiconductor, Inc. 2010, 2012. All rights reserved.



X-ON Electronics

Largest Supplier of Electrical and Electronic Components

Click to view similar products for [RF MOSFET Transistors](#) category:

Click to view products by [Freescale](#) manufacturer:

Other Similar products are found below :

[MRF166W](#) [MHT1006NT1](#) [FH2164](#) [MRFE8VP8600HR5](#) [BLF245](#) [BLF278](#) [ARF1511](#) [ARF465BG](#) [BF 2030 E6814](#) [BLF861A](#) [3SK263-5-TG-E](#) [VRF154FL](#) [MRF6S20010GNR1](#) [DU1215S](#) [DU28200M](#) [VRF150MP](#) [MMRF1015NR1](#) [MRF154](#) [MRF175LU](#) [MRF6S20010GNR1](#) [UF28100M](#) [MW6S010GNR1](#) [MW6S010GNR1](#) [DU2820S](#) [SD2943W](#) [SD2932BW](#) [SD2941-10W](#) [MRF24301HR5](#) [ARF469AG](#) [ARF463BP1G](#) [MMRF1019NR4](#) [MHT1008NT1](#) [MMRF1014NT1](#) [MRF426](#) [MRF422](#) [BLW96](#) [ARF468AG](#) [VRF161MP](#) [ARF468BG](#) [MRFE6VP61K25NR6](#) [MRFE6VP5300NR1](#) [A2T27S020NR1](#) [MMRF1304NR1](#) [MRFE6S9060GNR1](#) [MMRF1008GHR5](#) [A2T27S007NT1](#) [AFT09MP055NR1](#) [DU2860U](#) [MHT1803A](#) [D2081UK.F](#)