

FSHY 佛山好运

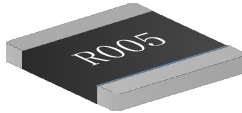

合金贴片电阻2728

● 特征 Features



- 阻值范围 Resistance value: 4~50mΩ
- 精度 Tolerance: ±1%, ±5%
- 功率 Power: 4W
- 温度系数 Temperature coefficient: ±50ppm/°C
- 电子束焊接结构 Electron-beam welding
- 推荐工作范围 Recommended operating temperature range: -55°C~155°C
- 符合ROHS要求 Lead-free
- 特殊规格可以订做 Special tolerance is available on request

● 尺寸规格 Dimensions Data

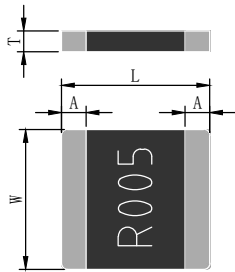

尺寸 Type	长 L/mm	宽 W/mm	脚长 A/mm	厚度 T/mm	阻值范围 R/mΩ
2728	7.2±0.2	6.8±0.2	0.9±0.2 1.2±0.2	1.0±0.1	4~50

● 推荐焊盘尺寸 Recommend Solder Pand Dimensions

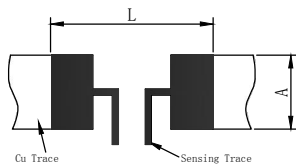

Size	Dimensions	
	A/mm	L/mm
2728	7.8	9.0

● 品名构成 Type Designation

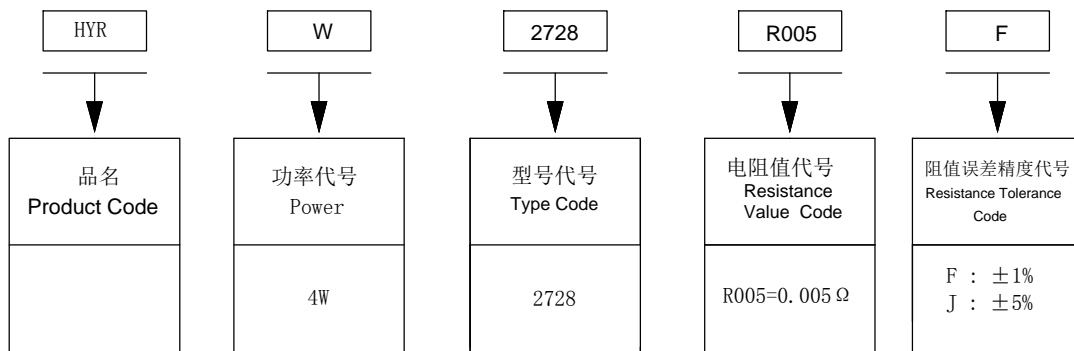

● 特性 Characteristics

项目 Item	标准 Specifications	测试方法 Test Methods
可焊性 Solderability	可焊面积 \geq 95% 95% Cover Min	IEC 60115-1 4.17 245 \pm 5 $^{\circ}$ C锡槽, 保持3s \pm 0.3s Lead-free solder bath at 245 \pm 5 $^{\circ}$ C for 3s \pm 0.3s
电阻温度系数 T. C. R	在规定值内 Within specified T. C. R	IEC 60115-1 4.8 20 $^{\circ}$ C-120 $^{\circ}$ C
温度快速变化 Rapid Change of Temperature	无可见损伤 No mechanical damage $\Delta R \leq \pm 1.0\%R$	IEC 60115-1 4.19 -55 $^{\circ}$ C (30分钟) \sim 常温 (5分钟) \sim 125 $^{\circ}$ C (30分钟) 100个循环。 -55 $^{\circ}$ C (30min) \sim normal temperature (5min) \sim 125 $^{\circ}$ C (30min) 100 cycles.
耐焊接热 Resistance to Soldering Heat	无可见损伤 No mechanical damage $\Delta R \leq \pm 1.0\%R$	IEC 60115-1 4.18 260 $^{\circ}$ C, 保持10s \pm 1s。 Lead-free solder bath at 260 \pm 5 $^{\circ}$ C for 10s \pm 1s.
短时间过负载 Short time overload	无可见损伤 No mechanical damage $\Delta R \leq \pm 1.0\%R$	IEC 60115-1 4.13 3W:3倍额定功率, 保持5秒; 4W:2倍额定功率, 保持5秒。 3W:Rated power \times 3 for 5 seconds; 4W:Rated power \times 2 for 5 seconds.
基板弯曲试验 Substrate Bending Test	无可见损伤 No mechanical damage $\Delta R \leq \pm 1.0\%R$	IEC 60115-1 4.33 弯曲距离 (Bending Distance) :2mm 保持时间 (duration) :60s \pm 5s
稳态湿热 Damp Heat Steady State	无可见损伤 No mechanical damage $\Delta R \leq \pm 1.0\%R$	IEC 60115-1 4.24 40 $^{\circ}$ C \pm 2 $^{\circ}$ C, 93 \pm 3%RH, 1000小时, 额定电流或元件极限电流 (取较少值) 通1.5小时/断0.5小时。 40 $^{\circ}$ C \pm 2 $^{\circ}$ C, 93 \pm 3%RH, 1000 hours, Rated current or limiting element current whichever is lower 1.5h ON/0.5h OFF.
70 $^{\circ}$ C耐久性 Endurance at 70 $^{\circ}$ C	无可见损伤 No mechanical damage $\Delta R \leq \pm 1.0\%R$	IEC 60115-1 4.25.1 70 $^{\circ}$ C \pm 2 $^{\circ}$ C, 1000小时, 额定电流或元件极限电流 (取较少者) 通 1.5小时/断0.5小时。 70 $^{\circ}$ C \pm 2 $^{\circ}$ C, 1000h, Rated current or limiting element curren t whichever is lower 1.5h ON/0.5h OFF
上限类别温度耐久性 Endurance at Upper Category Temperature	无可见损伤 No mechanical damage $\Delta R \leq \pm 1.0\%R$	IEC 60115-1 4.25.3 170 $^{\circ}$ C \pm 2 $^{\circ}$ C, 1000小时 170 $^{\circ}$ C \pm 2 $^{\circ}$ C, 1000h
耐溶性 Component Solvent Resistance	无可见损伤 No mechanical damage $\Delta R \leq \pm 1.0\%R$	IEC 60115-1 4.29 异丙醇 (IPA), 23 $^{\circ}$ C \pm 5 $^{\circ}$ C, 浸10小时 Iso-propyl alcohol (IPA), 23 $^{\circ}$ C \pm 5 $^{\circ}$ C, 10h

● 电气性能 Electrical Features

* 表面温度曲线 Surface Temperature Curve

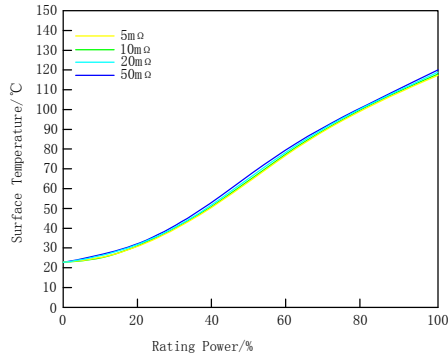

备注：表面温度测试板采用铝基板
Note: Surface temperature rise test boards use aluminum substrate

* 温度系数曲线 TCR Derating Curve

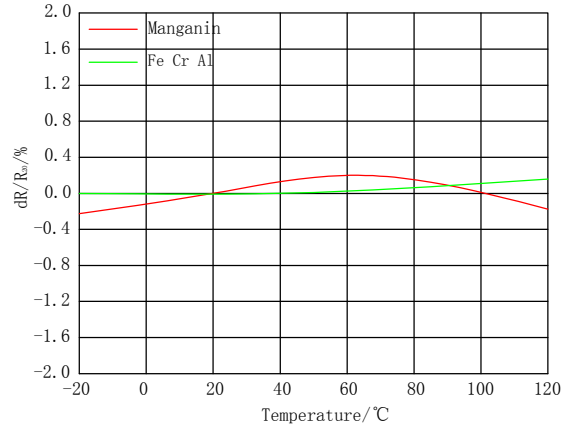

* 负荷下降曲线 Derating Curve

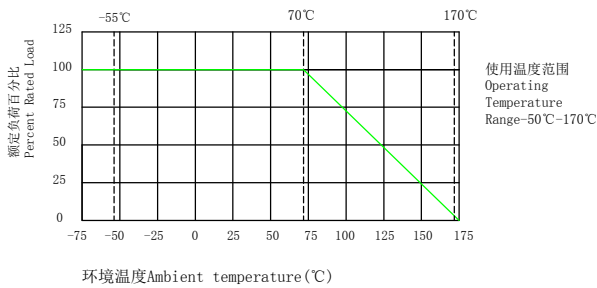

环境温度 Ambient temperature (°C)

* 应用范围 Applications

- 过流保护 Over current protection
- 电流采样 Current sense applications
- 伺服电机控制电路 Servo motor control circuits
- 智能功率模块 Intelligent power modules
- 工业电脑模块及精密测量系统 industrial PC modules and precision measurement system
- 高速CPU外围设备中的电流检测电路 Current detection circuits in high-speed CPU peripherals

● 编带包装 Tape and Reel

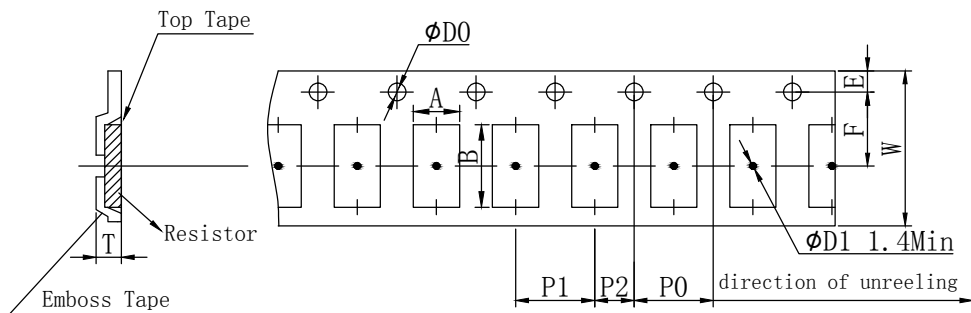

Type	A	B	W	E	F	P0	P1	P2	ØD0	T	Quantity (EA)
2728	7.7	7.2	12	1.75	5.5	4	12	2	1.5	1.45	3000

X-ON Electronics

Largest Supplier of Electrical and Electronic Components

Click to view similar products for [Current Sense Resistors - SMD category](#):

Click to view products by [FSHY manufacturer](#):

Other Similar products are found below :

[5112](#) [65709-330JE](#) [PF2512FKF7W0R007L](#) [PR2512FKF7W0R003L](#) [PR2512FKF7W0R005L](#) [RCWL0603R500JNEA](#) [ERJ-3BQF1R1V](#) [ERJ-L14UJ42MU](#) [2-2176088-5](#) [PF2512FKF7W0R006L](#) [PF2512FKF7W0R033L](#) [2-2176089-4](#) [CD2015FC-0.10-1%](#) [PR2512FKF7W0R004L](#) [CGSSL1R01J](#) [RC1005F124CS](#) [RCWE2512R110FKEA](#) [RCWL0805R330JNEA](#) [RL73H3AR47FTE](#) [RL73K3AR56JTDF](#) [RL7520WT-R001-F](#) [RL7520WT-R009-G](#) [RL7520WT-R020-F](#) [RLP73N1ER43JTD](#) [TL3AR01FTDG](#) [TLR3A20DR0005FTDG](#) [LRC-LR2512LF-01-R820J](#) [ERJ-3BQF4R3V](#) [ERJ-L14UF68MU](#) [TLR3A20DR001FTDG](#) [TLR3A30ER0005FTDG](#) [WR06X104JGLJ](#) [RLP73K1ER82JTD](#) [TL2BR01F](#) [TLR3A20DR01FTDG](#) [WSR3R0600FEA32](#) [ERJ-14BQF1R6U](#) [ERJ-14BQJR30U](#) [SP1220RJT](#) [SP1R12J](#) [ERJ-14BQF6R2U](#) [RL7520WT-R039-G](#) [PF1206FRF7W0R02L](#) [RL7520WT-R002-F](#) [RL7520WT-R047-F](#) [RLP73N2BR068FTDF](#) [RL7520WT-R005-F](#) [RCWE2512R220FKEA](#) [RCWE120625L0FMEA](#) [RCWE1206R150FKEA](#)