

## Metal Oxide Varistors (MOV) Data Sheet

### Features

- Fast responding to transient over-voltage
- Large absorbing transient energy capability
- Low clamping ratio and no follow-on current
- Meets MSL level 1, per J-STD-020
- Operating Temperature: -40°C ~ +105°C & -40°C ~ +125°C
- Storage Temperature: -40°C ~ +125°C
- Agency recognition: UL 1449 4th /cUL/TUV/VDE/CQC

### Applications

- Power supply, Telecommunication, Smart meter, or PLC protection
- Surge protection in consumer electronics
- Surge protection in industrial electronics
- Surge protection in electronic home appliances, gas and petroleum appliances
- Relay and electromagnetic valve surge absorption

### Part Number Code

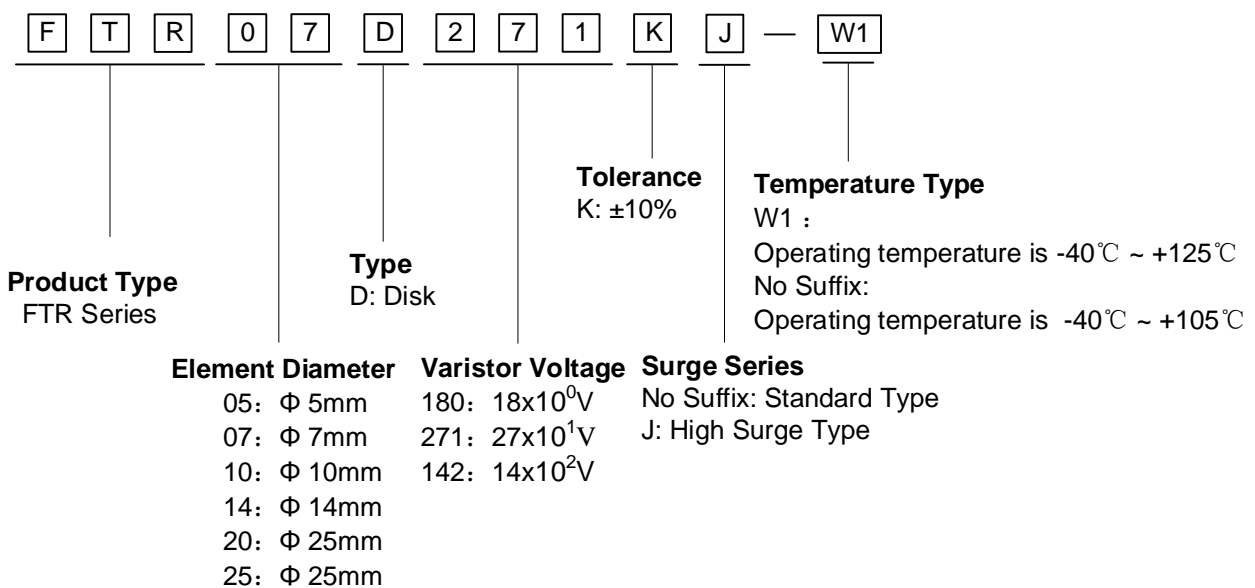

**Electrical Characteristics**

Part Number		Maximum Allowable Voltage		Varistor Voltage	Maximum Clamping Voltage		Withstanding Surge current		Maximum Energy (10/1000μs)		Rated Power	Dimension T <sub>max</sub>
Standard	High Surge	V <sub>AC</sub> (V)	V <sub>DC</sub> (V)	V <sub>1mA</sub> (V)	I <sub>P</sub> (A)	V <sub>C</sub> (V)	(A) Standard	(A) High Surge	(J) Standard	(J) High Surge	(W)	(mm)
FTR07D180K	FTR07D180KJ	11	14	18(15~21.6)	2.5	36	250	500	0.9	2	0.02	5.0
FTR07D220K	FTR07D220KJ	14	18	22(19.5~26)	2.5	43	250	500	1.1	2.4	0.02	5.0
FTR07D270K	FTR07D270KJ	17	22	27(24~31)	2.5	53	250	500	1.4	3	0.02	5.0
FTR07D330K	FTR07D330KJ	20	26	33(29.5~36.5)	2.5	65	250	500	1.7	3.5	0.02	5.0
FTR07D390K	FTR07D390KJ	25	31	39(35~43)	2.5	77	250	500	2.1	4	0.02	5.0
FTR07D470K	FTR07D470KJ	30	38	47(42~52)	2.5	93	250	500	2.5	5	0.02	5.0
FTR07D560K	FTR07D560KJ	35	45	56(50~62)	2.5	110	250	500	3.1	6	0.02	5.0
FTR07D680K	FTR07D680KJ	40	56	68(61~75)	2.5	135	250	500	3.6	7	0.02	5.0
FTR07D820K	FTR07D820KJ	50	65	82(74~90)	10	135	1200	1750	5	10	0.25	5.0
FTR07D101K	FTR07D101KJ	60	85	100(90~110)	10	165	1200	1750	6.5	12	0.25	3.8
FTR07D121K	FTR07D121KJ	75	100	120(108~132)	10	200	1200	1750	7.8	13	0.25	4.0
FTR07D151K	FTR07D151KJ	95	125	150(135~165)	10	250	1200	1750	9.7	15	0.25	3.6
FTR07D181K	FTR07D181KJ	115	150	180(162~198)	10	300	1200	1750	11.7	16	0.25	3.7
FTR07D201K	FTR07D201KJ	130	170	200(180~220)	10	340	1200	1750	13	17	0.25	3.8
FTR07D221K	FTR07D221KJ	140	180	220(198~242)	10	360	1200	1750	14	19	0.25	3.9
FTR07D241K	FTR07D241KJ	150	200	240(216~264)	10	395	1200	1750	15	21	0.25	4.0
FTR07D271K	FTR07D271KJ	175	225	270(243~297)	10	455	1200	1750	18	24	0.25	4.2
FTR07D301K	FTR07D301KJ	190	250	300(270~330)	10	500	1200	1750	20	26	0.25	4.3
FTR07D331K	FTR07D331KJ	210	275	330(297~363)	10	550	1200	1750	23	28	0.25	4.3
FTR07D361K	FTR07D361KJ	230	300	360(324~396)	10	595	1200	1750	24	32	0.25	4.5
FTR07D391K	FTR07D391KJ	250	320	390(351~429)	10	650	1200	1750	26	35	0.25	4.6
FTR07D431K	FTR07D431KJ	275	350	430(387~473)	10	710	1200	1750	28	40	0.25	4.8
FTR07D471K	FTR07D471KJ	300	385	470(423~517)	10	775	1200	1750	29	42	0.25	5.0
FTR07D511K	FTR07D511KJ	320	415	510(459~561)	10	845	1200	1750	31	45	0.25	5.2
FTR07D561K	FTR07D561KJ	350	460	560(504~616)	10	925	1200	1750	35	49	0.25	5.4
FTR07D621K	FTR07D621KJ	385	505	620(558~682)	10	1025	1200	1750	38	55	0.25	5.7
FTR07D681K	FTR07D681KJ	420	560	680(612~748)	10	1120	1200	1750	42	60	0.25	6.0
FTR07D751K	FTR07D751KJ	460	615	750(675~825)	10	1240	1200	1750	45	64	0.25	6.1
FTR07D781K	FTR07D781KJ	485	640	780(702~858)	10	1290	1200	1750	48	69	0.25	6.2
FTR07D821K	FTR07D821KJ	510	670	820(738~902)	10	1355	1200	1750	52	73	0.25	6.4

Notes: 1. The tolerance of varistor voltage between 18V and 27V is more than 10%.

2. Leakage Current (@83% of V<sub>1mA</sub>): IR≤50μA (180K~680K) ; IR≤25μA (820K~112K)

### Dimensions

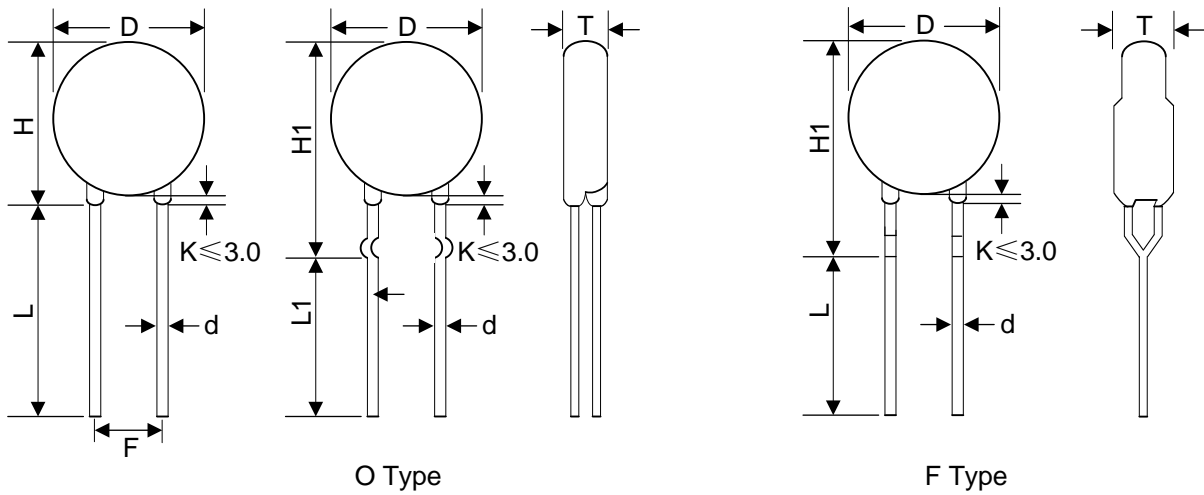

O Type

F Type

Symbol	H(max.)	H1(Max.)	L(min.)	L1(min.)	D (max.)	F(±0.8)	d(±0.05)	Tmax
Dimension(mm)	11.5	13	20	15	9	5	0.6	Please refer to the Electrical Characteristics Table

### Marking Code

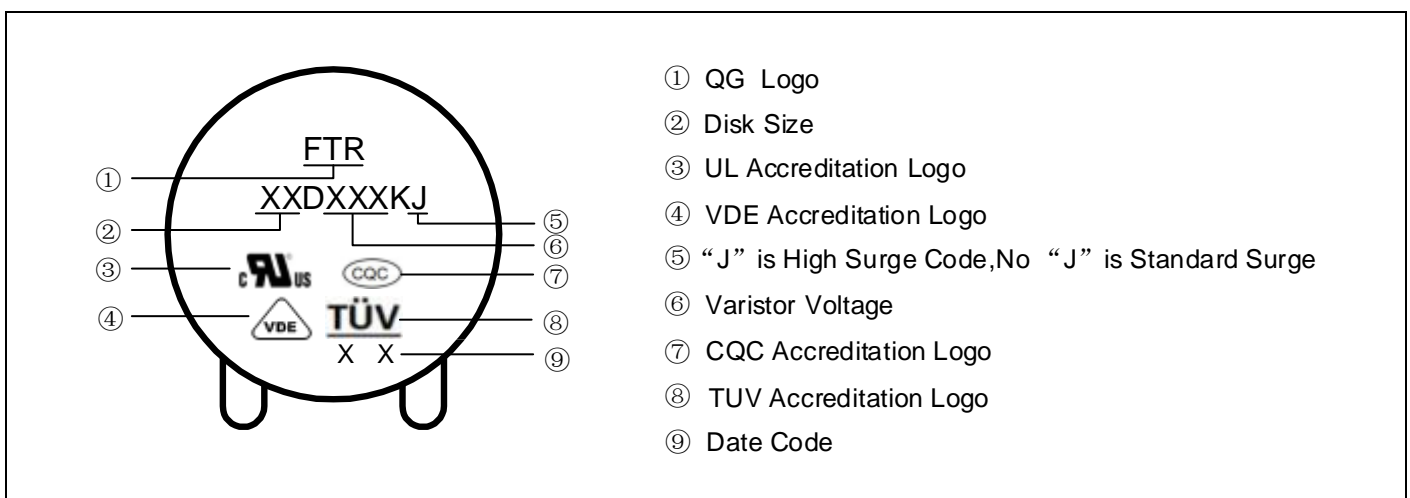

### Electrical Ratings

Items	Test Condition/Description	Requirement					
Varistor Voltage	The voltage between two terminals with the specified measuring current 1mA.DC applied is called Vb.	To meet the Specified value					
Maximum Allowable Voltage	The recommended maximum sine wave voltage (RMS) or the Maximum DC voltage can be applied continuously.						
Maximum Clamping Voltage	<p>The maximum voltage between two terminals with the specification standard impulse current. Applied waveform: 8/20μs</p>						
Rated Wattage	The maximum average power that can be applied within the specified ambient temperature.						
Energy	The maximum energy within the varistor voltage change of ±10% when one impulse of 10/1000μs or 2ms is applied.						
Withstanding Surge Current	The maximum current within the varistor voltage change of ±10% with the standard impulse current (8/20μs) applied one time.						
Varistor Voltage Temp. Coefficient	$\left  \frac{V_{1mA@85^{\circ}C} - V_{1mA@25^{\circ}C}}{V_{1mA@25^{\circ}C}} \times \frac{1}{60} \times 100\% (\%/^{\circ}C) \right $ $\left  \frac{V_{1mA@-40^{\circ}C} - V_{1mA@25^{\circ}C}}{V_{1mA@25^{\circ}C}} \times \frac{1}{65} \times 100\% (\%/^{\circ}C) \right $		≤0.05%/°C				
Surge Life	<p>The change of Vb shall be measured after the impulse listed below which is applied 10,000 times continuously with the interval of ten seconds at room temperature.</p> <table border="1" style="margin-left: auto; margin-right: auto;"> <tbody> <tr> <td rowspan="2" style="text-align: center;">7Φ series</td> <td style="text-align: center;">180K to 680K</td> <td style="text-align: center;">25A (8/20μs)</td> </tr> <tr> <td style="text-align: center;">820K to 112K</td> <td style="text-align: center;">60A (8/20μs)</td> </tr> </tbody> </table>	7Φ series	180K to 680K	25A (8/20μs)	820K to 112K	60A (8/20μs)	$\frac{\Delta V_b}{V_b} \leq \pm 10\%$
7Φ series	180K to 680K		25A (8/20μs)				
	820K to 112K	60A (8/20μs)					

**Mechanical Characteristics**

Items	Test conditions / Methods	Specifications								
Tensile Strength of Terminals	Gradually applying the force specified and keeping the unit fixed for 10±1 sec. <table border="1"> <tr> <td>Terminal diameter (mm)</td> <td>Force(kg)</td> </tr> <tr> <td>0.5&lt;d≤0.8</td> <td>1.0</td> </tr> <tr> <td>0.8&lt;d≤1.25</td> <td>2.0</td> </tr> <tr> <td>1.25&lt;d</td> <td>4.0</td> </tr> </table>	Terminal diameter (mm)	Force(kg)	0.5<d≤0.8	1.0	0.8<d≤1.25	2.0	1.25<d	4.0	NO Visible damage  Δ V1mA/V1mA  ≤5%
Terminal diameter (mm)	Force(kg)									
0.5<d≤0.8	1.0									
0.8<d≤1.25	2.0									
1.25<d	4.0									
Bending Strength of Terminals	Hold specimen and apply the force specified below to each lead. Bend the specimen to 90°, then return to the original position. Repeat the procedure in the opposite direction. <table border="1"> <tr> <td>Terminal diameter (mm)</td> <td>Force(kg)</td> </tr> <tr> <td>0.5&lt;d≤0.8</td> <td>0.5</td> </tr> <tr> <td>0.8&lt;d≤1.25</td> <td>1.0</td> </tr> <tr> <td>1.25&lt;d</td> <td>2.0</td> </tr> </table>	Terminal diameter (mm)	Force(kg)	0.5<d≤0.8	0.5	0.8<d≤1.25	1.0	1.25<d	2.0	NO Visible damage  Δ V1mA/V1mA  ≤5%
Terminal diameter (mm)	Force(kg)									
0.5<d≤0.8	0.5									
0.8<d≤1.25	1.0									
1.25<d	2.0									
Vibration	Frequency range: 10~55 Hz Amplitude: 0.75mm or 98m/s <sup>2</sup> Direction: 3 mutually perpendicular directions, 2hrs each.	NO Visible damage  Δ V1mA/V1mA  ≤5%								
Solder ability	Solder Temp: 245±5°C Dipping Time: 2±0.5 sec	At least 95% of terminal electrode is covered by new solder								
Resistanceto Soldering Heat	Solder Temp: 260±5°C Dipping Time: 10±1 sec	NO Visible damage  Δ V1mA/V1mA  ≤5%								

**Reliability**

Items	Test conditions / Methods	Specifications															
High Temperature Storage	Ambient Temp: 125±2°C Duration: 1000hrs	Δ V1mA/V1mA  ≤5%															
Low Temperature Storage	Ambient Temp: -40±2°C Duration: 1000hrs	Δ V1mA/V1mA  ≤5%															
Humidity	Ambient Temp: 40±2°C, 90~95% R.H. Duration: 1000hrs	Δ V1mA/V1mA  ≤5%															
Temperature Cycle	The conditions shown below shall be repeated 5 cycles <table border="1"> <thead> <tr> <th>Step</th> <th>Temperature (°C)</th> <th>Period (minutes)</th> </tr> </thead> <tbody> <tr> <td>1</td> <td>-40±3</td> <td>30±3</td> </tr> <tr> <td>2</td> <td>Room temperature</td> <td>15±3</td> </tr> <tr> <td>3</td> <td>125±3</td> <td>30±3</td> </tr> <tr> <td>4</td> <td>Room temperature</td> <td>15±3</td> </tr> </tbody> </table>	Step	Temperature (°C)	Period (minutes)	1	-40±3	30±3	2	Room temperature	15±3	3	125±3	30±3	4	Room temperature	15±3	No visible damage  ΔV1mA/V1mA  ≤5%
Step	Temperature (°C)	Period (minutes)															
1	-40±3	30±3															
2	Room temperature	15±3															
3	125±3	30±3															
4	Room temperature	15±3															
High Temperature Load	Ambient Temp: 105±2°C Duration: 1000hrs Load: Max. Allowable Voltage In AC eara.	ΔV1mA/V1mA  ≤5%															
Damp Heat Load	Ambient Temp: 40±2°C, 90~95% R.H. Duration: 1000hrs Load: Max. Allowable Voltage	No visible damage  ΔV1mA/V1mA  ≤5%															
Voltage Proof	Metal balls method, 2500Vac 1 min.	No visible damage															

## Soldering Recommendation

### Wave Lead Free Soldering Recommendation



Item	Conditions
Peak Temperature	265°C
Dipping Time	10 seconds(max.)
Soldering	1 time

### Recommendation Reworking Conditions with Soldering Iron

Item	Conditions
Temperature of Soldering Iron-tip	360°C(max.)
Soldering Time	3 seconds(max.)
Distance from Varistor	2mm (min.)

Maximum Leakage Current and Maximum Clamping Voltage Curve

07D180K to 07D680K

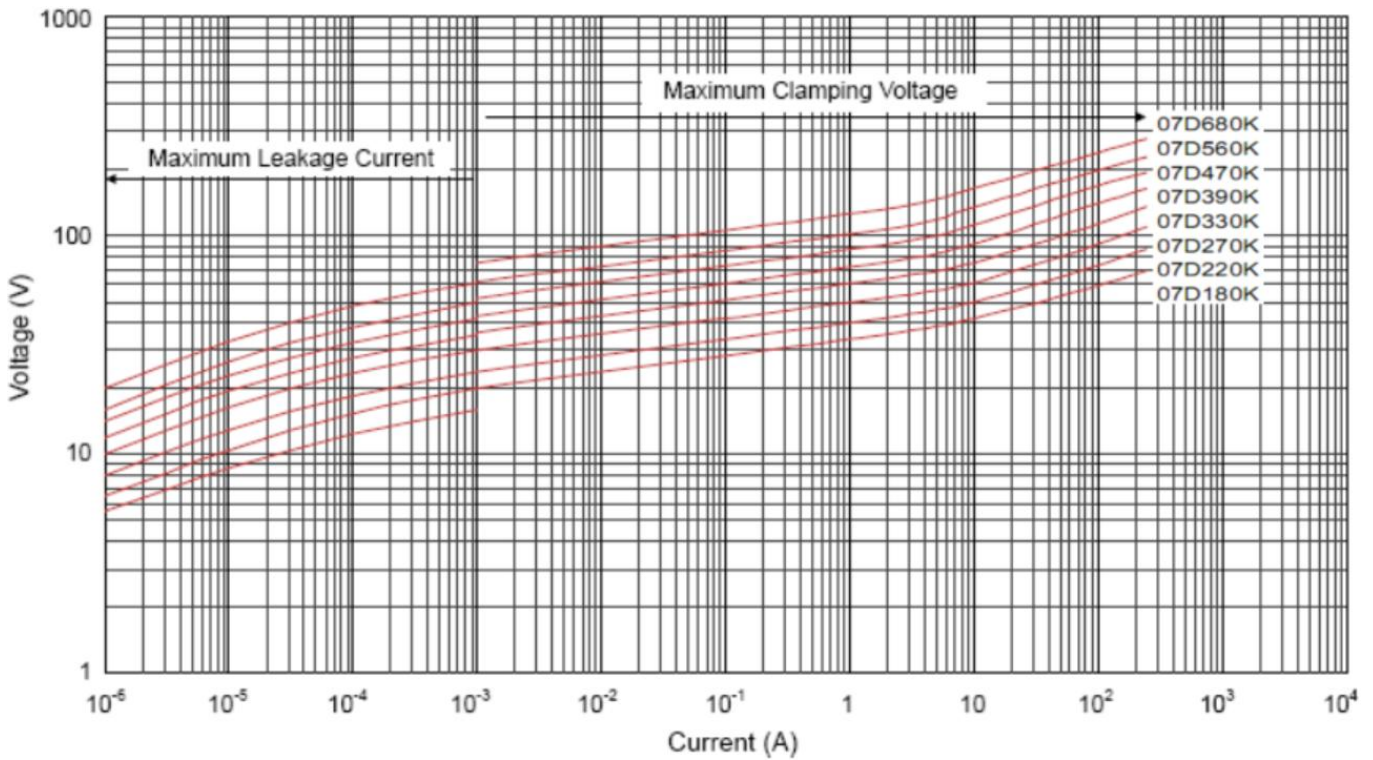

07D820K to 07D471K

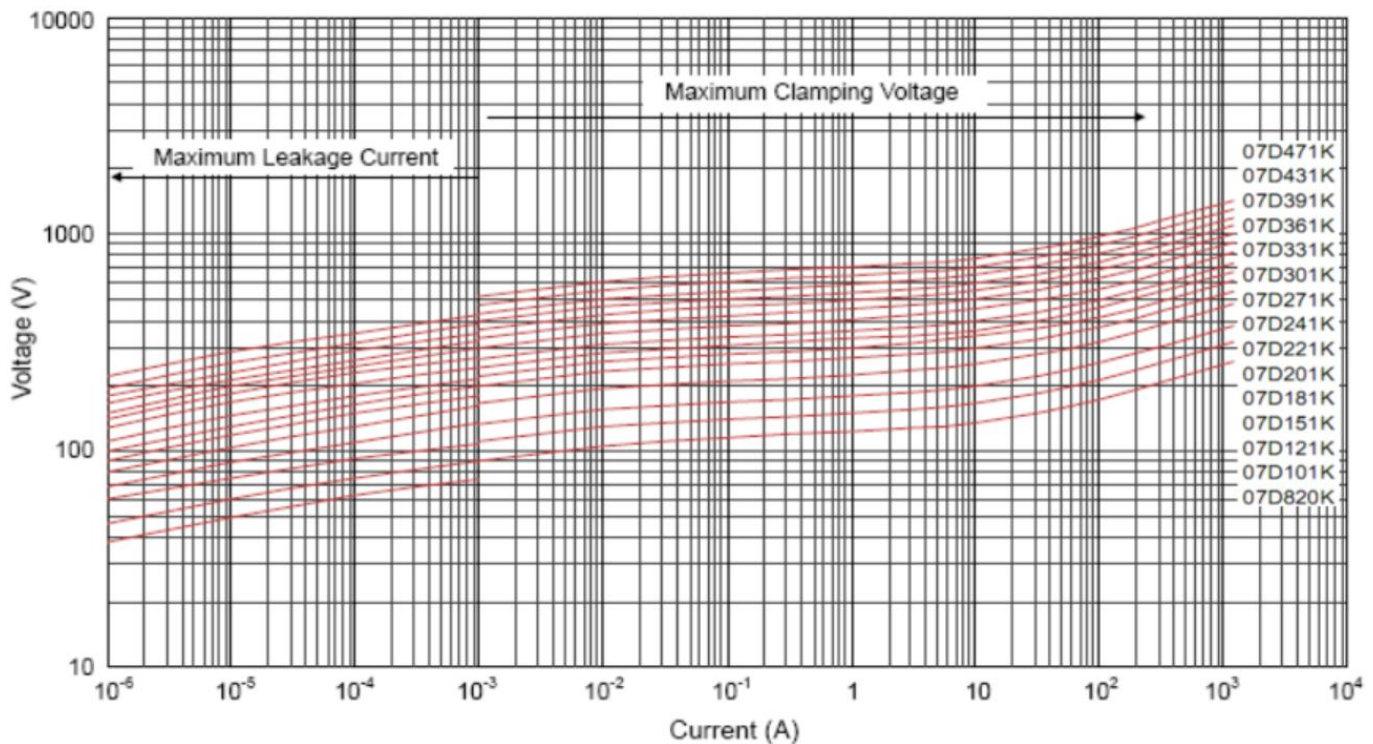

Maximum Leakage Current and Maximum Clamping Voltage Curve

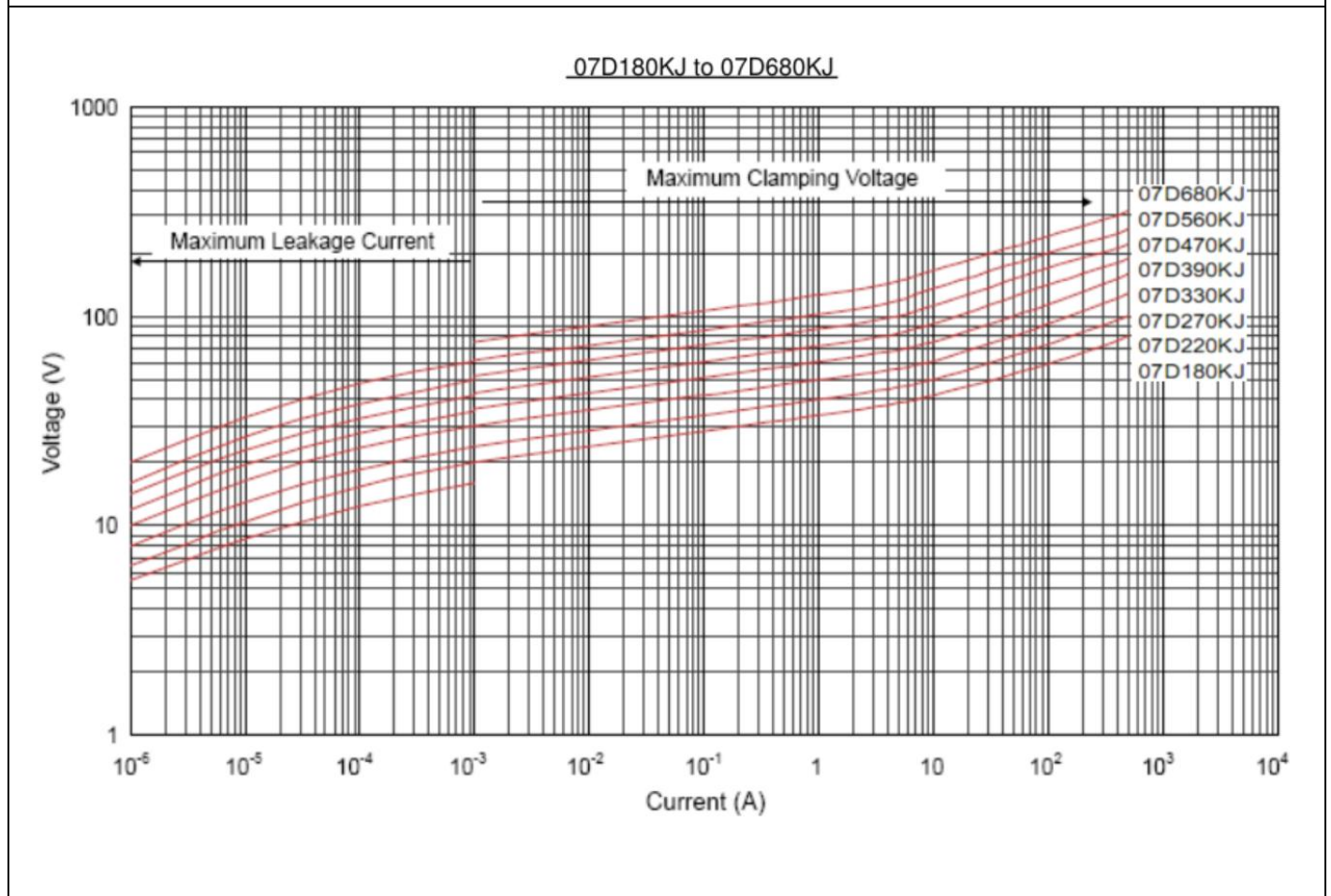
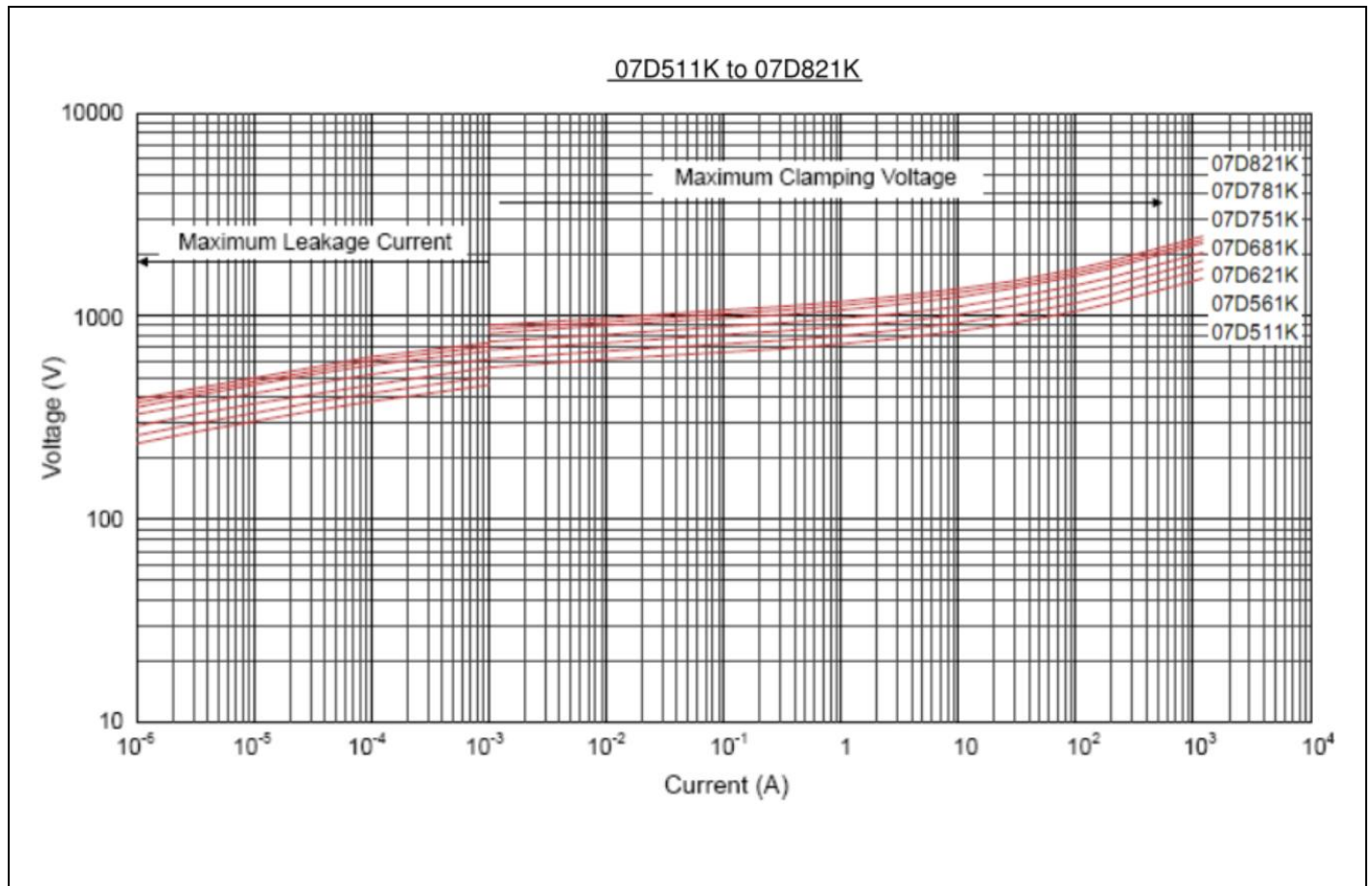



Maximum Leakage Current and Maximum Clamping Voltage Curve

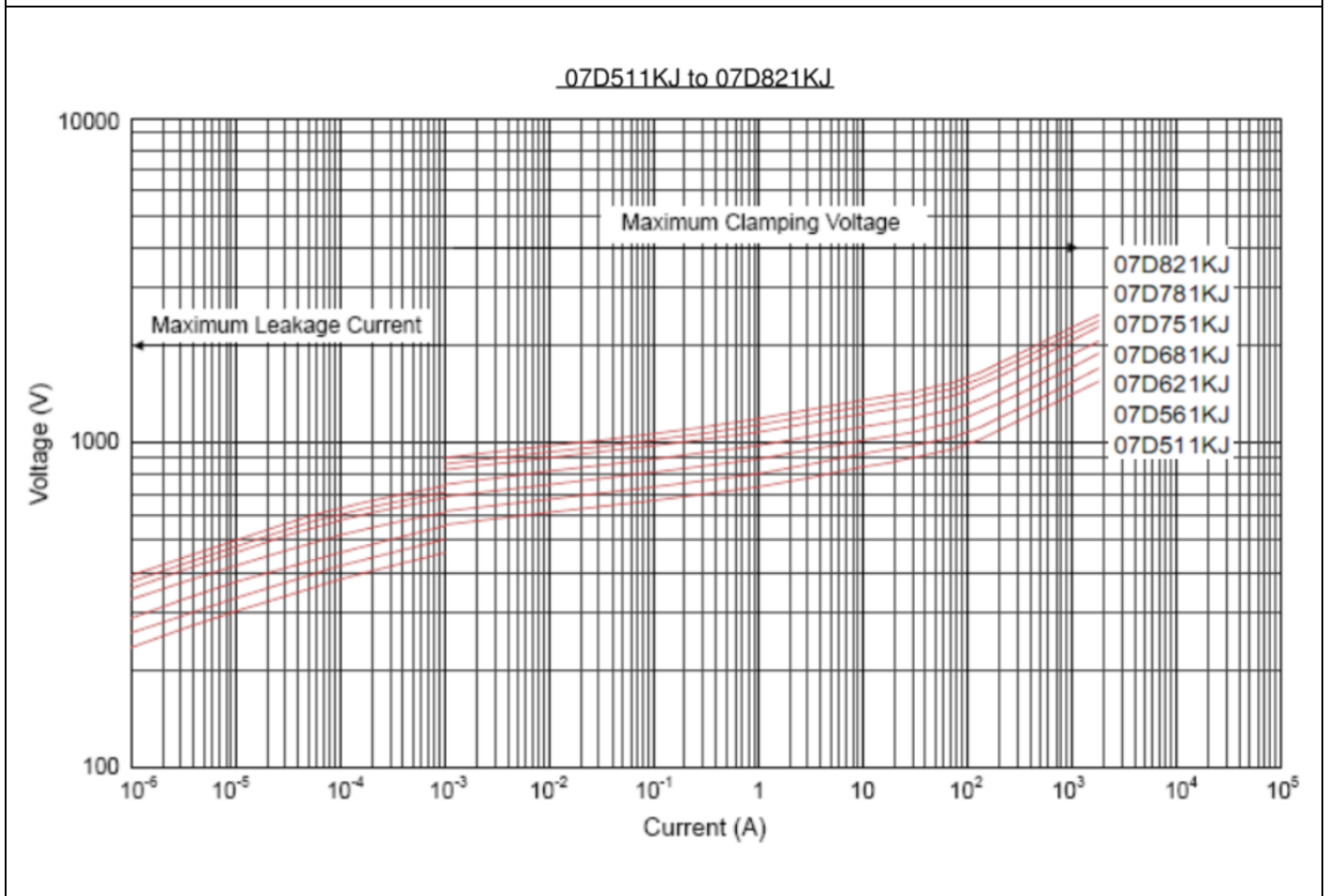
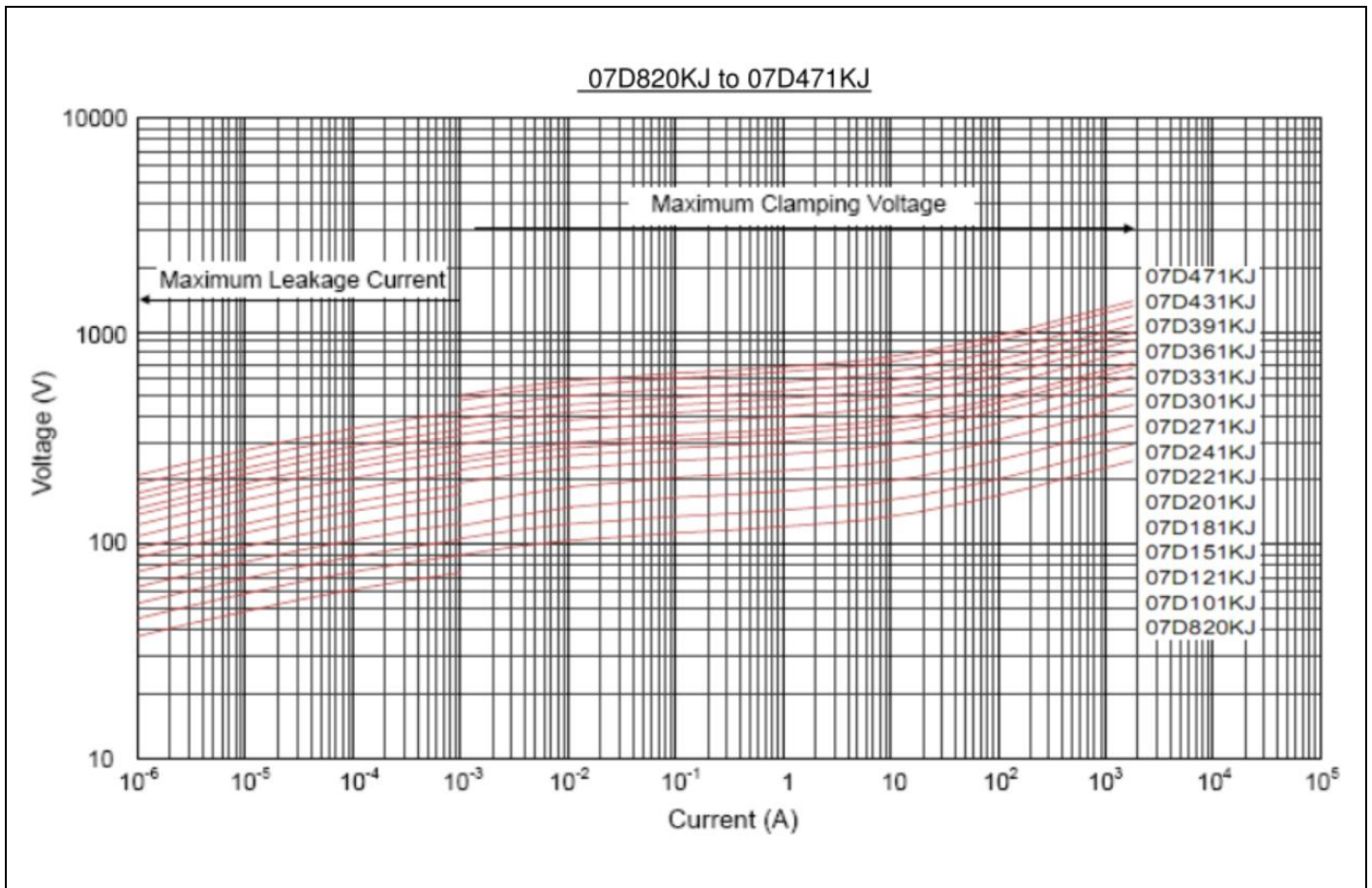

### Maximum Surge Current Derating Curve

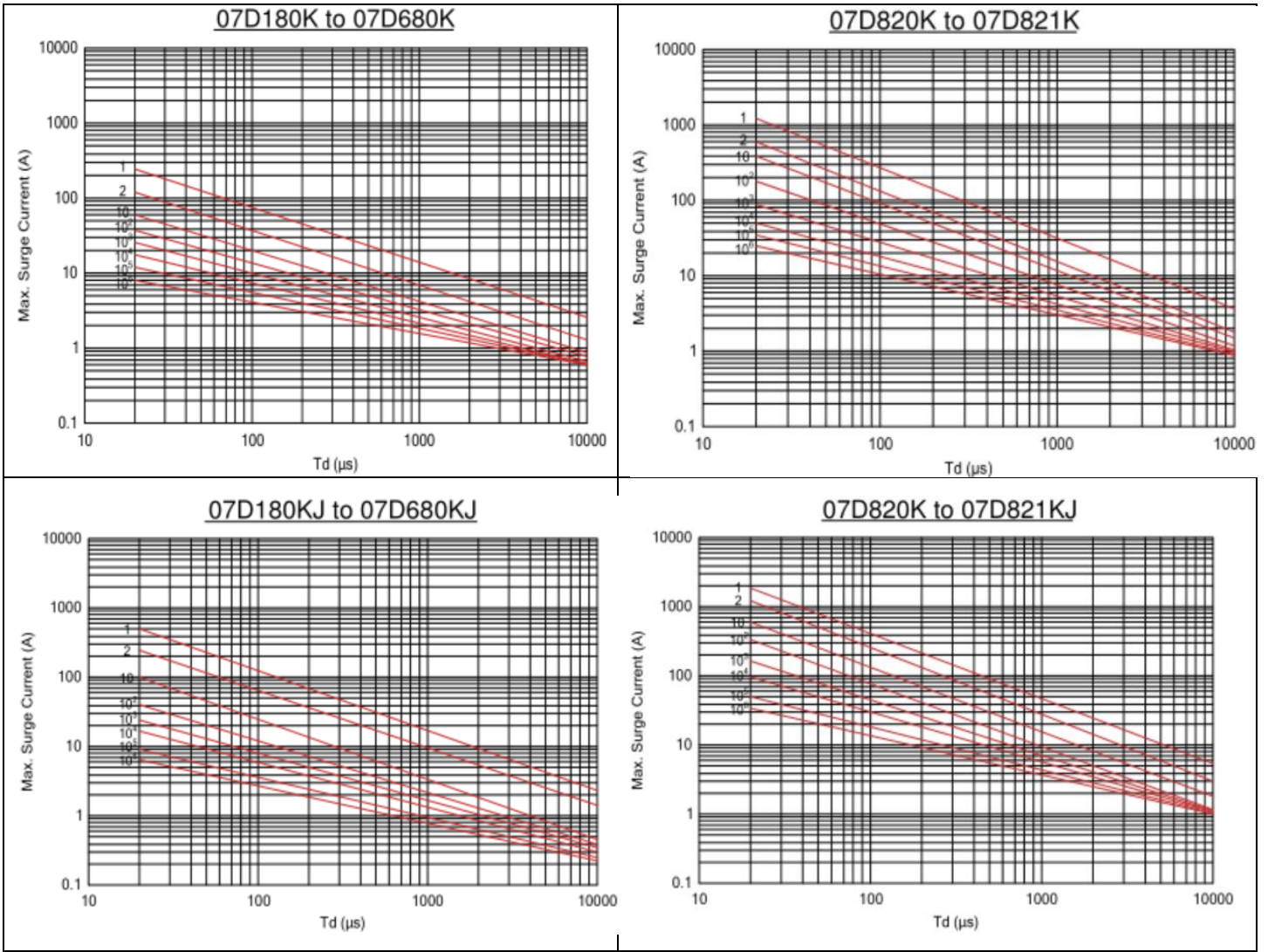

### Taping Dimensions

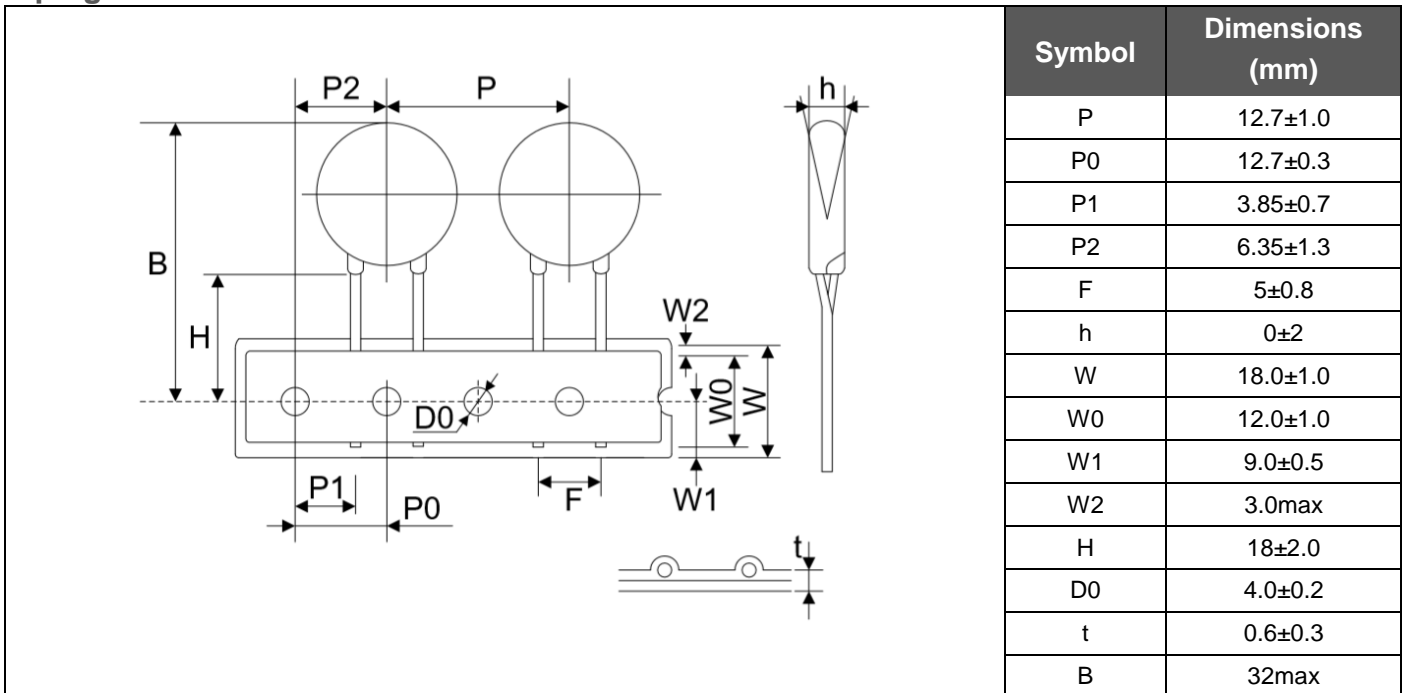

### Quantity

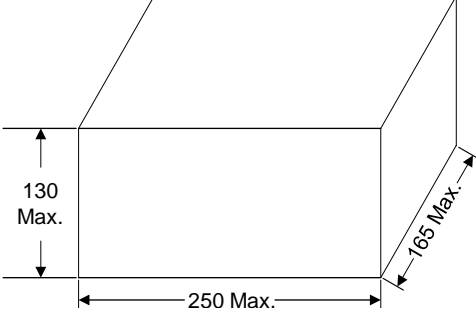
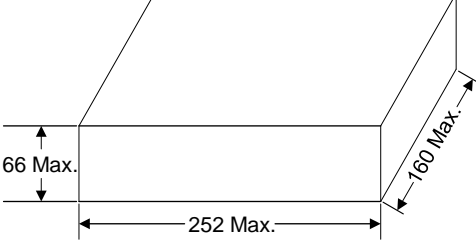
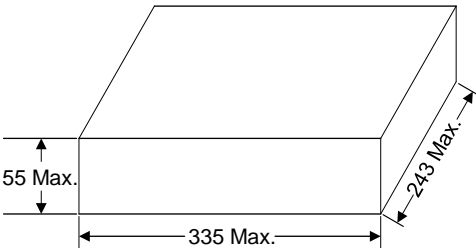
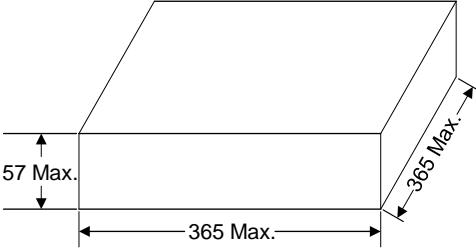
Packaging Dimensions (Unit: mm)	Quantity	
<p>In bulk for Terminals Untrimmed Products</p> 	1000pcs/bag	4bags/box
<p>In bulk for Terminals Trimmed Products</p> 		
<p>Tape &amp; Box</p> 	1500pcs/bag (180K~391K)	6bags/box
	1000pcs/bag (431K~821K)	
<p>Tape &amp; Reel</p> 	2000pcs/bag (180K~331K)	6bags/box
	1500pcs/bag (361k~821K)	

## X-ON Electronics

Largest Supplier of Electrical and Electronic Components

*Click to view similar products for [Varistors](#) category:*

*Click to view products by [FTR](#) manufacturer:*

Other Similar products are found below :

[R71ZOV151HC](#) [B72205S271K111](#) [B72214S251K151](#) [NTE1V020](#) [NTE1V130](#) [25FN511K](#) [S10K11G5S5](#) [ERZ-C14DK361U](#) [ERZ-C20DK221U](#) [ERZ-C32CK201B](#) [207869-1](#) [AS-13](#) [B72214S200K551](#) [B72280B112K1](#) [B72540E 350K 62](#) [B72590D360A60](#) [B72650M301K93](#) [B72670M1140K72](#) [TVZ18EC271KBS](#) [TVZ20EB911KBS](#) [TVZ25D201KBS](#) [TVZ25D241KBS](#) [VDRH20X230BSE](#) [VZ07D220KBS](#) [VZ40D241KQ-N](#) [VZ40D241K](#) [VZ25D511KBS-N](#) [VZ20E511KBSX](#) [VZ20E221KBSX](#) [VZ10D471KBS-N](#) [ERZ-V20R221](#) [B72205S350K211](#) [B72214S110K551](#) [B72510E140K62](#) [B72650M151K93](#) [B72650M350K72](#) [TVZ25DN271KBS](#) [TVZ25D301KBS](#) [TVZ20EC911KBS](#) [TVZ20EBN911KBS](#) [TVZ18EC471KBS](#) [B72220S350K101](#) [B72540E300K62](#) [TND10V-271KB00AAA0](#) [NTE1V030](#) [NTE1V275](#) [NTE2V015](#) [NTE2V035](#) [NTE2V115](#) [CN1206K11G](#)