

Metal Oxide Varistors (MOV) Data Sheet

Features

- Fast responding to transient over-voltage
- Large absorbing transient energy capability
- Low clamping ratio and no follow-on current
- Meets MSL level 1, per J-STD-020
- Operating Temperature: -40°C ~ +105°C & -40°C ~ +125°C
- Storage Temperature: -40°C ~ +125°C
- Agency recognition: UL 1449 4th /cUL/TUV/VDE/CQC

Applications

- Power supply, Telecommunication, Smart meter, or PLC protection
- Surge protection in consumer electronics
- Surge protection in industrial electronics
- Surge protection in electronic home appliances, gas and petroleum appliances
- Relay and electromagnetic valve surge absorption

Part Number Code

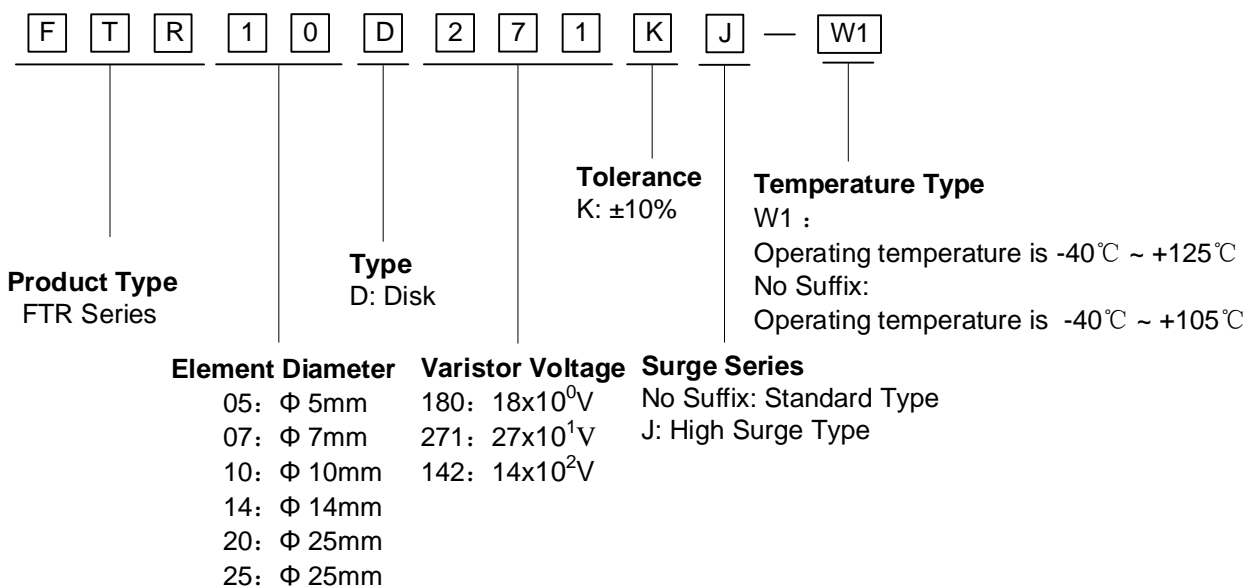

Electrical Characteristics

| Part Number | | Maximum Allowable Voltage | | Varistor Voltage | Maximum Clamping Voltage | | Withstanding Surge current | | Maximum Energy (10/1000μs) | | Rated Power | Dimension T _{max} |
|-------------|-------------|---------------------------|---------------------|----------------------|--------------------------|--------------------|----------------------------|----------------|----------------------------|----------------|-------------|----------------------------|
| Standard | High Surge | V _{AC} (V) | V _{DC} (V) | V _{1mA} (V) | I _P (A) | V _C (V) | (A) Standard | (A) High Surge | (J) Standard | (J) High Surge | (W) | (mm) |
| FTR10D180K | FTR10D180KJ | 11 | 14 | 18(15~21.6) | 5 | 36 | 500 | 1000 | 2.1 | 3 | 0.05 | 5.0 |
| FTR10D220K | FTR10D220KJ | 14 | 18 | 22(19.5~26) | 5 | 43 | 500 | 1000 | 2.5 | 5 | 0.05 | 5.0 |
| FTR10D270K | FTR10D270KJ | 17 | 22 | 27(24~31) | 5 | 53 | 500 | 1000 | 3 | 6 | 0.05 | 5.0 |
| FTR10D330K | FTR10D330KJ | 20 | 26 | 33(29.5~36.5) | 5 | 65 | 500 | 1000 | 4 | 7 | 0.05 | 5.0 |
| FTR10D390K | FTR10D390KJ | 25 | 31 | 39(35~43) | 5 | 77 | 500 | 1000 | 4.6 | 9 | 0.05 | 5.0 |
| FTR10D470K | FTR10D470KJ | 30 | 38 | 47(42~52) | 5 | 93 | 500 | 1000 | 5.5 | 11 | 0.05 | 5.0 |
| FTR10D560K | FTR10D560KJ | 35 | 45 | 56(50~62) | 5 | 110 | 500 | 1000 | 7 | 13 | 0.05 | 5.0 |
| FTR10D680K | FTR10D680KJ | 40 | 56 | 68(61~75) | 5 | 135 | 500 | 1000 | 8.2 | 15 | 0.05 | 5.0 |
| FTR10D820K | FTR10D820KJ | 50 | 65 | 82(74~90) | 25 | 135 | 2500 | 3500 | 12 | 17 | 0.4 | 5.0 |
| FTR10D101K | FTR10D101KJ | 60 | 85 | 100(90~110) | 25 | 165 | 2500 | 3500 | 15 | 18 | 0.4 | 4.2 |
| FTR10D121K | FTR10D121KJ | 75 | 100 | 120(108~132) | 25 | 200 | 2500 | 3500 | 18 | 21 | 0.4 | 4.4 |
| FTR10D151K | FTR10D151KJ | 95 | 125 | 150(135~165) | 25 | 250 | 2500 | 3500 | 22 | 25 | 0.4 | 4.0 |
| FTR10D181K | FTR10D181KJ | 115 | 150 | 180(162~198) | 25 | 300 | 2500 | 3500 | 27 | 30 | 0.4 | 4.1 |
| FTR10D201K | FTR10D201KJ | 130 | 170 | 200(180~220) | 25 | 340 | 2500 | 3500 | 30 | 35 | 0.4 | 4.2 |
| FTR10D221K | FTR10D221KJ | 140 | 180 | 220(198~242) | 25 | 360 | 2500 | 3500 | 32 | 39 | 0.4 | 4.3 |
| FTR10D241K | FTR10D241KJ | 150 | 200 | 240(216~264) | 25 | 395 | 2500 | 3500 | 35 | 42 | 0.4 | 4.4 |
| FTR10D271K | FTR10D271KJ | 175 | 225 | 270(243~297) | 25 | 455 | 2500 | 3500 | 37 | 49 | 0.4 | 4.6 |
| FTR10D301K | FTR10D301KJ | 190 | 250 | 300(270~330) | 25 | 500 | 2500 | 3500 | 40 | 54 | 0.4 | 4.7 |
| FTR10D331K | FTR10D331KJ | 210 | 275 | 330(297~363) | 25 | 550 | 2500 | 3500 | 43 | 58 | 0.4 | 4.7 |
| FTR10D361K | FTR10D361KJ | 230 | 300 | 360(324~396) | 25 | 595 | 2500 | 3500 | 47 | 65 | 0.4 | 4.9 |
| FTR10D391K | FTR10D391KJ | 250 | 320 | 390(351~429) | 25 | 650 | 2500 | 3500 | 60 | 70 | 0.4 | 5.0 |
| FTR10D431K | FTR10D431KJ | 275 | 350 | 430(387~473) | 25 | 710 | 2500 | 3500 | 65 | 80 | 0.4 | 5.2 |
| FTR10D471K | FTR10D471KJ | 300 | 385 | 470(423~517) | 25 | 775 | 2500 | 3500 | 67 | 85 | 0.4 | 5.4 |
| FTR10D511K | FTR10D511KJ | 320 | 415 | 510(459~561) | 25 | 845 | 2500 | 3500 | 69 | 90 | 0.4 | 5.6 |
| FTR10D561K | FTR10D561KJ | 350 | 460 | 560(504~616) | 25 | 925 | 2500 | 3500 | 70 | 92 | 0.4 | 5.8 |
| FTR10D621K | FTR10D621KJ | 385 | 505 | 620(558~682) | 25 | 1025 | 2500 | 3500 | 72 | 95 | 0.4 | 6.1 |
| FTR10D681K | FTR10D681KJ | 420 | 560 | 680(612~748) | 25 | 1120 | 2500 | 3500 | 75 | 98 | 0.4 | 6.4 |
| FTR10D751K | FTR10D751KJ | 460 | 615 | 750(675~825) | 25 | 1240 | 2500 | 3500 | 77 | 100 | 0.4 | 6.5 |
| FTR10D781K | FTR10D781KJ | 485 | 640 | 780(702~858) | 25 | 1290 | 2500 | 3500 | 80 | 105 | 0.4 | 6.6 |
| FTR10D821K | FTR10D821KJ | 510 | 670 | 820(738~902) | 25 | 1355 | 2500 | 3500 | 85 | 110 | 0.4 | 6.8 |
| FTR10D911K | FTR10D911KJ | 550 | 745 | 910(819~1001) | 25 | 1500 | 2500 | 3500 | 93 | 130 | 0.4 | 7.2 |
| FTR10D102K | FTR10D102KJ | 625 | 825 | 1000(900~1100) | 25 | 1650 | 2500 | 3500 | 102 | 140 | 0.4 | 7.2 |
| FTR10D112K | FTR10D112KJ | 680 | 895 | 1100(990~1210) | 25 | 1815 | 2500 | 3500 | 115 | 155 | 0.4 | 7.6 |

Notes: 1. The tolerance of varistor voltage between 18V and 27V is more than 10%.

2. Leakage Current (@83% of V_{1mA}): IR ≤ 50μ A (180K~680K) ; IR ≤ 25μ A (820K~112K)

Dimensions

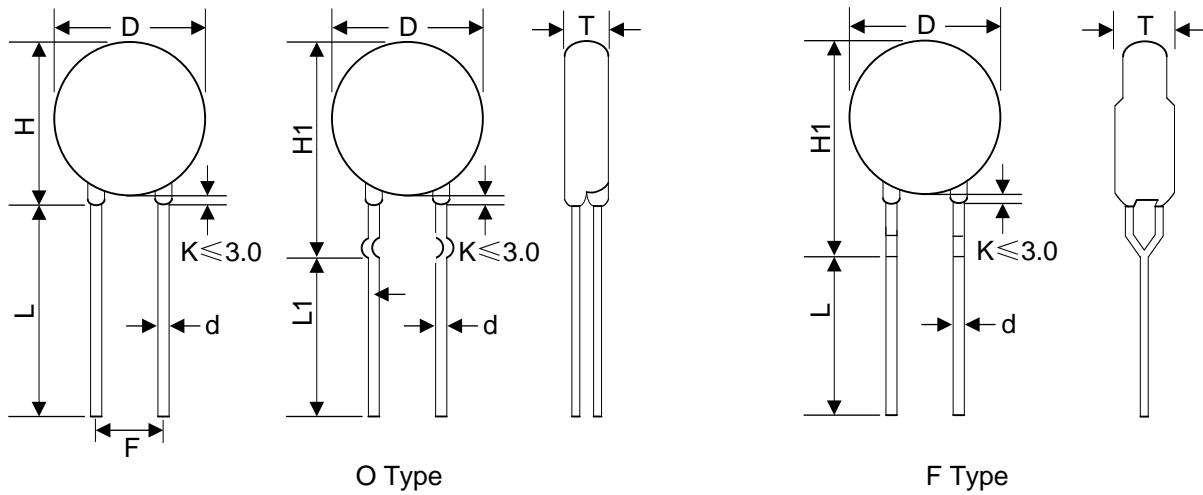

O Type

F Type

| Symbol | H(max.) | H1(Max.) | L(min.) | L1(min.) | D (max.) | F(±0.8) | d(±0.05) | Tmax |
|---------------|---------|----------|---------|----------|----------|---------|----------|--|
| Dimension(mm) | 14.5 | 16.5 | 20 | 15 | 12 | 7.5 | 0.8 | Please refer to the Electrical Characteristics Table |

Marking Code

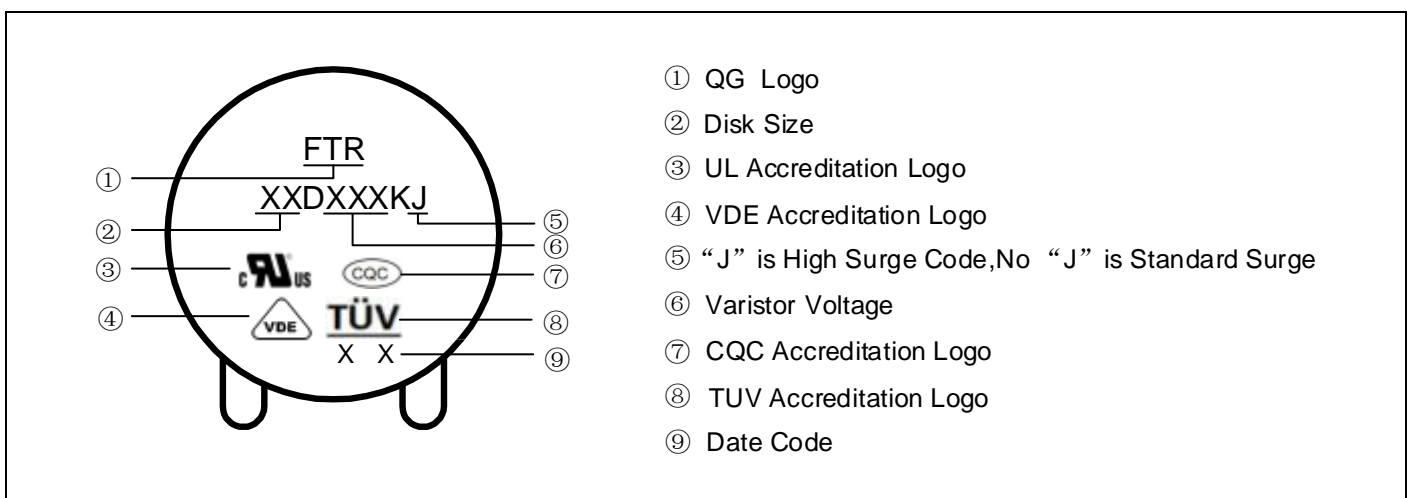

Electrical Ratings

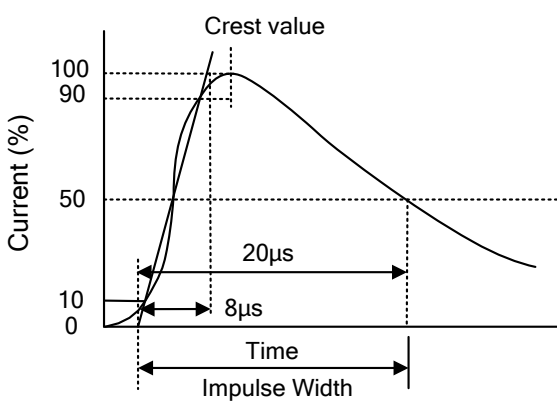
| Items | Test Condition/Description | Requirement | | | | | |
|------------------------------------|--|-----------------------------|--------------|--------------|--------------|---------------|--|
| Varistor Voltage | The voltage between two terminals with the specified measuring current 1mA.DC applied is called Vb. | To meet the Specified value | | | | | |
| Maximum Allowable Voltage | The recommended maximum sine wave voltage (RMS) or the Maximum DC voltage can be applied continuously. | | | | | | |
| Maximum Clamping Voltage | <p>The maximum voltage between two terminals with the specification standard impulse current. Applied waveform: 8/20μs</p>  | | | | | | |
| Rated Wattage | The maximum average power that can be applied within the specified ambient temperature. | | | | | | |
| Energy | The maximum energy within the varistor voltage change of ±10% when one impulse of 10/1000μs or 2ms is applied. | | | | | | |
| Withstanding Surge Current | The maximum current within the varistor voltage change of ±10% with the standard impulse current (8/20μs) applied one time. | | | | | | |
| Varistor Voltage Temp. Coefficient | $\left \frac{V_{1mA@85^{\circ}C} - V_{1mA@25^{\circ}C}}{V_{1mA@25^{\circ}C}} \times \frac{1}{60} \times 100\% (\%/^{\circ}C) \right $ $\left \frac{V_{1mA@-40^{\circ}C} - V_{1mA@25^{\circ}C}}{V_{1mA@25^{\circ}C}} \times \frac{1}{65} \times 100\% (\%/^{\circ}C) \right $ | | ≤0.05%/°C | | | | |
| Surge Life | <p>The change of Vb shall be measured after the impulse listed below which is applied 10,000 times continuously with the interval of ten seconds at room temperature.</p> <table border="1" data-bbox="438 1892 1204 2016"> <tbody> <tr> <td rowspan="2">10Φ series</td> <td>180K to 680K</td> <td>50A (8/20μs)</td> </tr> <tr> <td>820K to 112K</td> <td>100A (8/20μs)</td> </tr> </tbody> </table> | 10Φ series | 180K to 680K | 50A (8/20μs) | 820K to 112K | 100A (8/20μs) | $\frac{\Delta V_b}{V_b} \leq \pm 10\%$ |
| 10Φ series | 180K to 680K | | 50A (8/20μs) | | | | |
| | 820K to 112K | 100A (8/20μs) | | | | | |

Mechanical Characteristics

| Items | Test conditions / Methods | Specifications | | | | | | | | |
|-------------------------------|--|--|-----------|-----------|-----|------------|-----|--------|-----|--|
| Tensile Strength of Terminals | <p>Gradually applying the force specified and keeping the unit fixed for 10±1 sec.</p> <table border="1"> <tr> <td>Terminal diameter (mm)</td> <td>Force(kg)</td> </tr> <tr> <td>0.5<d≤0.8</td> <td>1.0</td> </tr> <tr> <td>0.8<d≤1.25</td> <td>2.0</td> </tr> <tr> <td>1.25<d</td> <td>4.0</td> </tr> </table> | Terminal diameter (mm) | Force(kg) | 0.5<d≤0.8 | 1.0 | 0.8<d≤1.25 | 2.0 | 1.25<d | 4.0 | <p>NO Visible damage Δ V1mA/V1mA ≤5%</p> |
| Terminal diameter (mm) | Force(kg) | | | | | | | | | |
| 0.5<d≤0.8 | 1.0 | | | | | | | | | |
| 0.8<d≤1.25 | 2.0 | | | | | | | | | |
| 1.25<d | 4.0 | | | | | | | | | |
| Bending Strength of Terminals | <p>Hold specimen and apply the force specified below to each lead. Bend the specimen to 90°, then return to the original position. Repeat the procedure in the opposite direction.</p> <table border="1"> <tr> <td>Terminal diameter (mm)</td> <td>Force(kg)</td> </tr> <tr> <td>0.5<d≤0.8</td> <td>0.5</td> </tr> <tr> <td>0.8<d≤1.25</td> <td>1.0</td> </tr> <tr> <td>1.25<d</td> <td>2.0</td> </tr> </table> | Terminal diameter (mm) | Force(kg) | 0.5<d≤0.8 | 0.5 | 0.8<d≤1.25 | 1.0 | 1.25<d | 2.0 | <p>NO Visible damage Δ V1mA/V1mA ≤5%</p> |
| Terminal diameter (mm) | Force(kg) | | | | | | | | | |
| 0.5<d≤0.8 | 0.5 | | | | | | | | | |
| 0.8<d≤1.25 | 1.0 | | | | | | | | | |
| 1.25<d | 2.0 | | | | | | | | | |
| Vibration | <p>Frequency range: 10~55 Hz Amplitude: 0.75mm or 98m/s² Direction: 3 mutually perpendicular directions, 2hrs each.</p> | <p>NO Visible damage Δ V1mA/V1mA ≤5%</p> | | | | | | | | |
| Solder ability | <p>Solder Temp: 245±5°C Dipping Time: 2±0.5 sec</p> | <p>At least 95% of terminal electrode is covered by new solder</p> | | | | | | | | |
| Resistanceto Soldering Heat | <p>Solder Temp: 260±5°C Dipping Time: 10±1 sec</p> | <p>NO Visible damage Δ V1mA/V1mA ≤5%</p> | | | | | | | | |

Reliability

| Items | Test conditions / Methods | Specifications | | | | | | | | | | | | | | | |
|--------------------------|---|---|------------------|------------------|---|-------|------|---|------------------|------|---|-------|------|---|------------------|------|---|
| High Temperature Storage | <p>Ambient Temp: 125±2°C Duration: 1000hrs</p> | <p> Δ V1mA/V1mA ≤5%</p> | | | | | | | | | | | | | | | |
| Low Temperature Storage | <p>Ambient Temp: -40±2°C Duration: 1000hrs</p> | <p> Δ V1mA/V1mA ≤5%</p> | | | | | | | | | | | | | | | |
| Humidity | <p>Ambient Temp: 40±2°C, 90~95% R.H. Duration: 1000hrs</p> | <p> Δ V1mA/V1mA ≤5%</p> | | | | | | | | | | | | | | | |
| Temperature Cycle | <p>The conditions shown below shall be repeated 5 cycles</p> <table border="1"> <thead> <tr> <th>Step</th> <th>Temperature (°C)</th> <th>Period (minutes)</th> </tr> </thead> <tbody> <tr> <td>1</td> <td>-40±3</td> <td>30±3</td> </tr> <tr> <td>2</td> <td>Room temperature</td> <td>15±3</td> </tr> <tr> <td>3</td> <td>125±3</td> <td>30±3</td> </tr> <tr> <td>4</td> <td>Room temperature</td> <td>15±3</td> </tr> </tbody> </table> | Step | Temperature (°C) | Period (minutes) | 1 | -40±3 | 30±3 | 2 | Room temperature | 15±3 | 3 | 125±3 | 30±3 | 4 | Room temperature | 15±3 | <p>No visible damage ΔV1mA/V1mA ≤5%</p> |
| Step | Temperature (°C) | Period (minutes) | | | | | | | | | | | | | | | |
| 1 | -40±3 | 30±3 | | | | | | | | | | | | | | | |
| 2 | Room temperature | 15±3 | | | | | | | | | | | | | | | |
| 3 | 125±3 | 30±3 | | | | | | | | | | | | | | | |
| 4 | Room temperature | 15±3 | | | | | | | | | | | | | | | |
| High Temperature Load | <p>Ambient Temp: 105±2°C Duration: 1000hrs Load: Max. Allowable Voltage In AC eara.</p> | <p> ΔV1mA/V1mA ≤5%</p> | | | | | | | | | | | | | | | |
| Damp Heat Load | <p>Ambient Temp: 40±2°C, 90~95% R.H. Duration: 1000hrs Load: Max. Allowable Voltage</p> | <p>No visible damage ΔV1mA/V1mA ≤5%</p> | | | | | | | | | | | | | | | |
| Voltage Proof | <p>Metal balls method, 2500Vac 1 min.</p> | <p>No visible damage</p> | | | | | | | | | | | | | | | |

Soldering Recommendation

Wave Lead Free Soldering Recommendation



| Item | Conditions |
|------------------|------------------|
| Peak Temperature | 265°C |
| Dipping Time | 10 seconds(max.) |
| Soldering | 1 time |

Recommendation Reworking Conditions with Soldering Iron

| Item | Conditions |
|-----------------------------------|-----------------|
| Temperature of Soldering Iron-tip | 360°C(max.) |
| Soldering Time | 3 seconds(max.) |
| Distance from Varistor | 2mm (min.) |

Maximum Leakage Current and Maximum Clamping Voltage Curve

10D180K to 10D680K

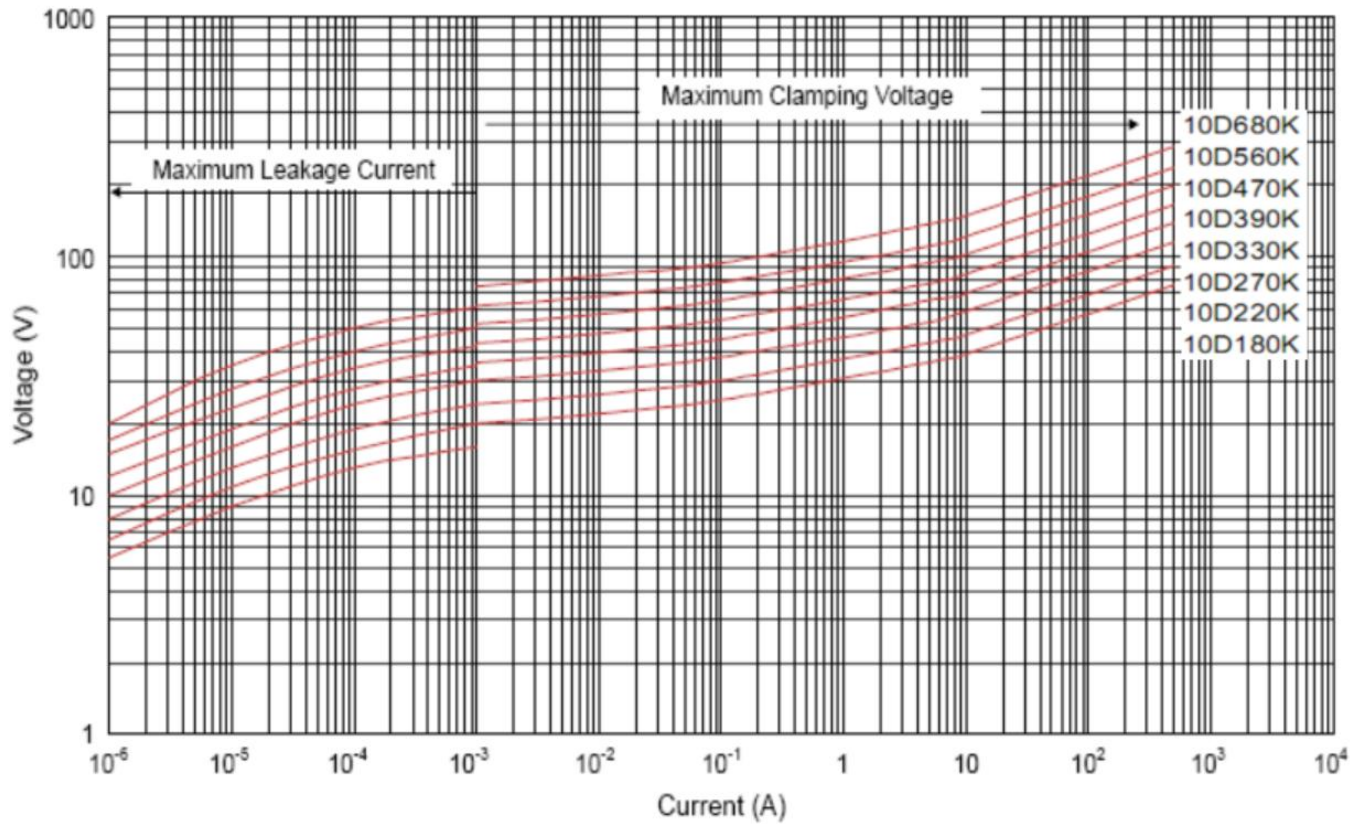

10D820K to 10D471K

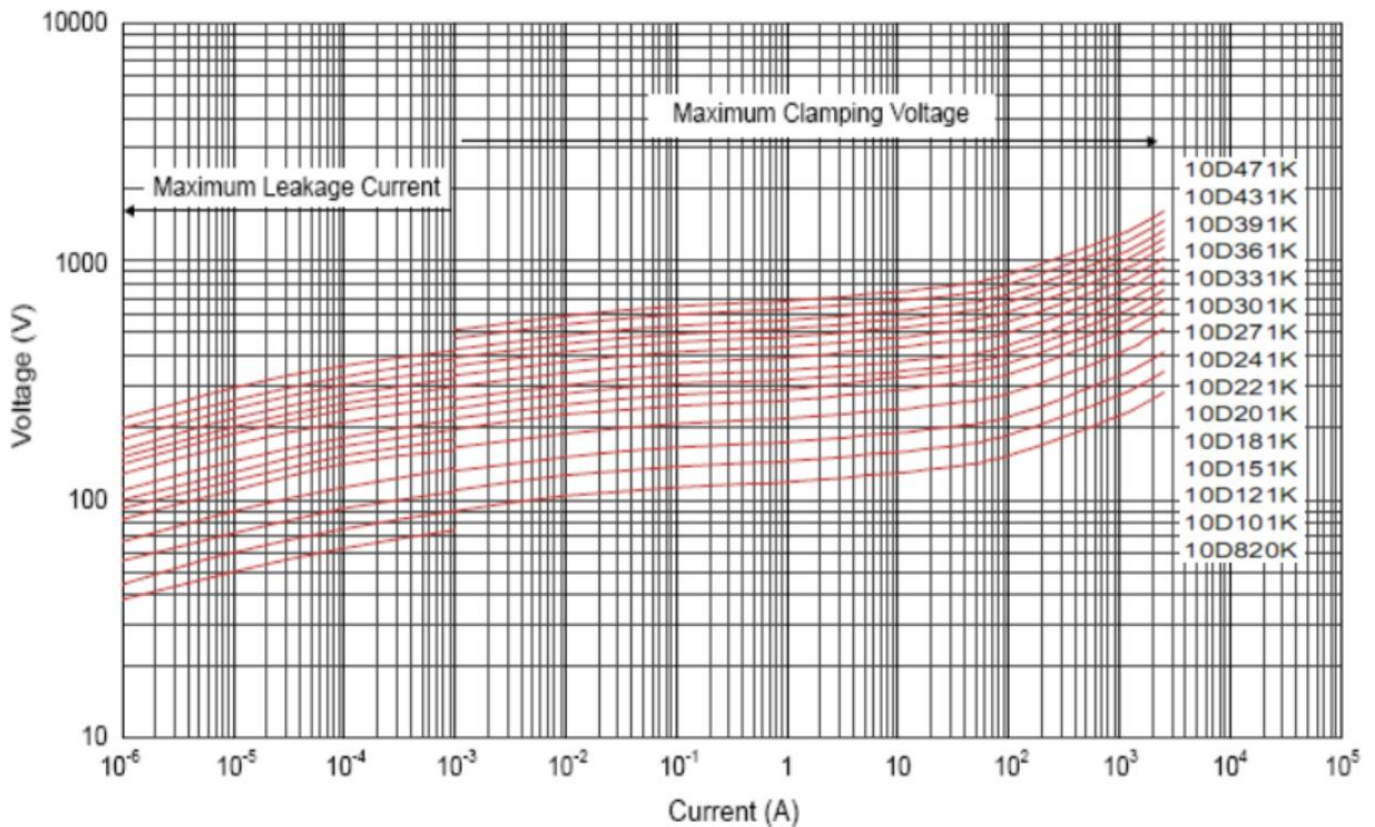

Maximum Leakage Current and Maximum Clamping Voltage Curve

10D511K to 10D112K

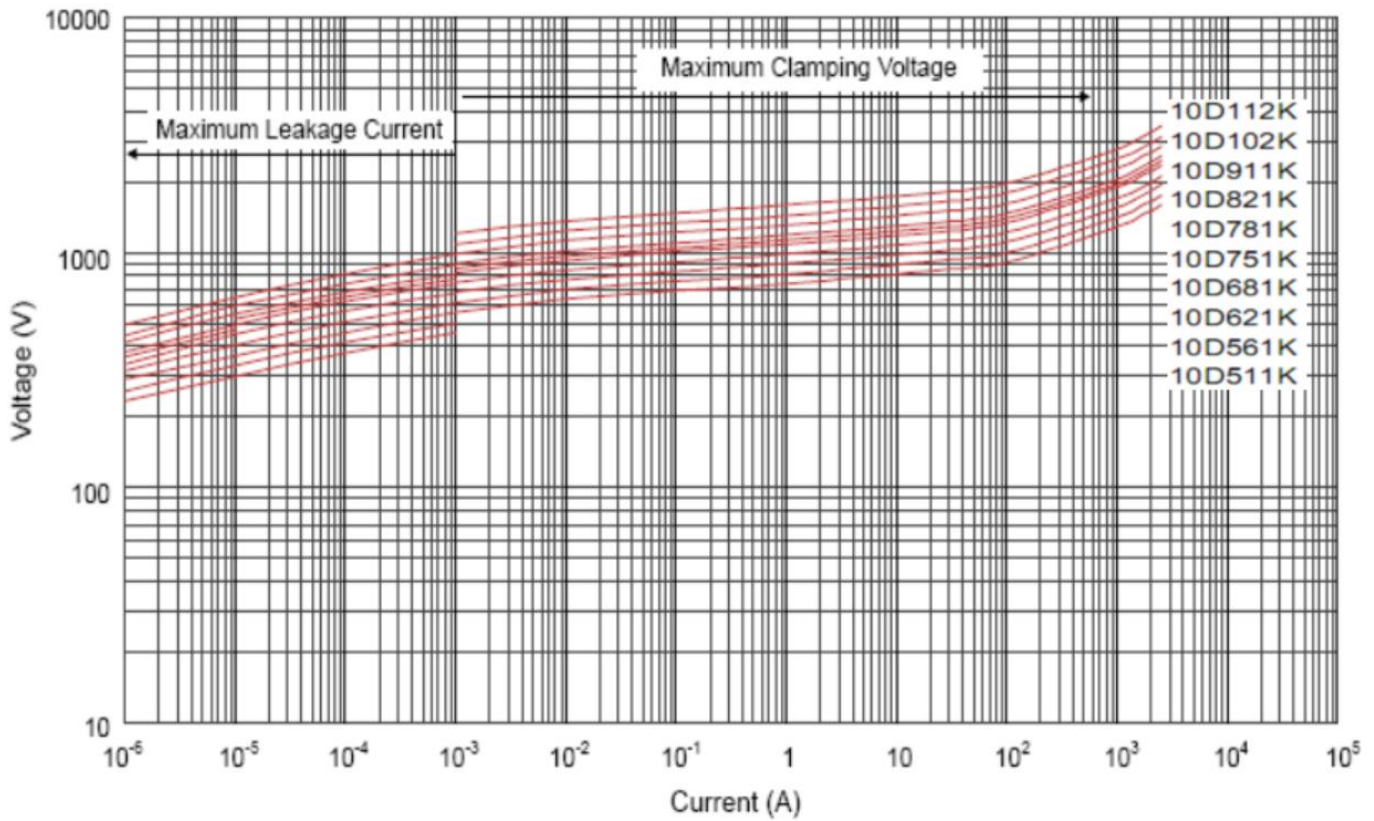

10D180KJ to 10D680KJ

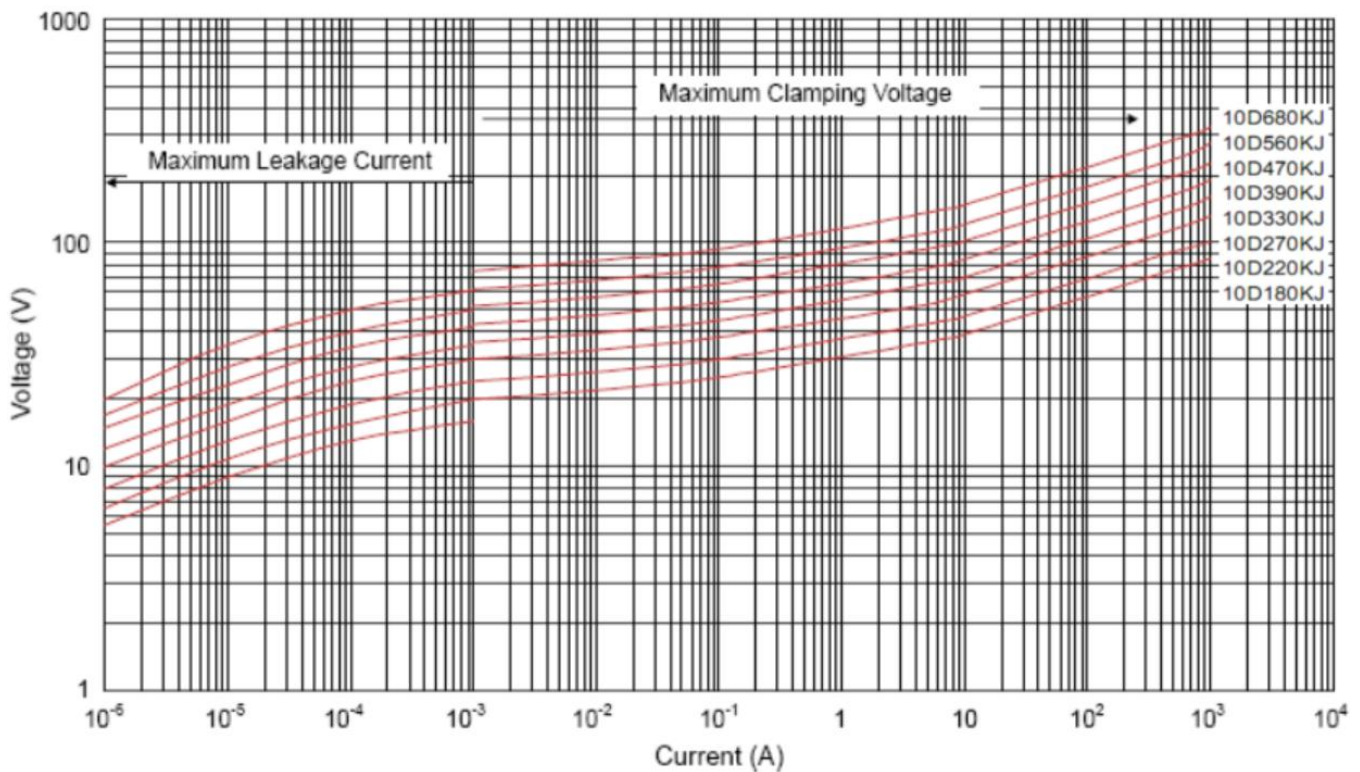

Maximum Leakage Current and Maximum Clamping Voltage Curve

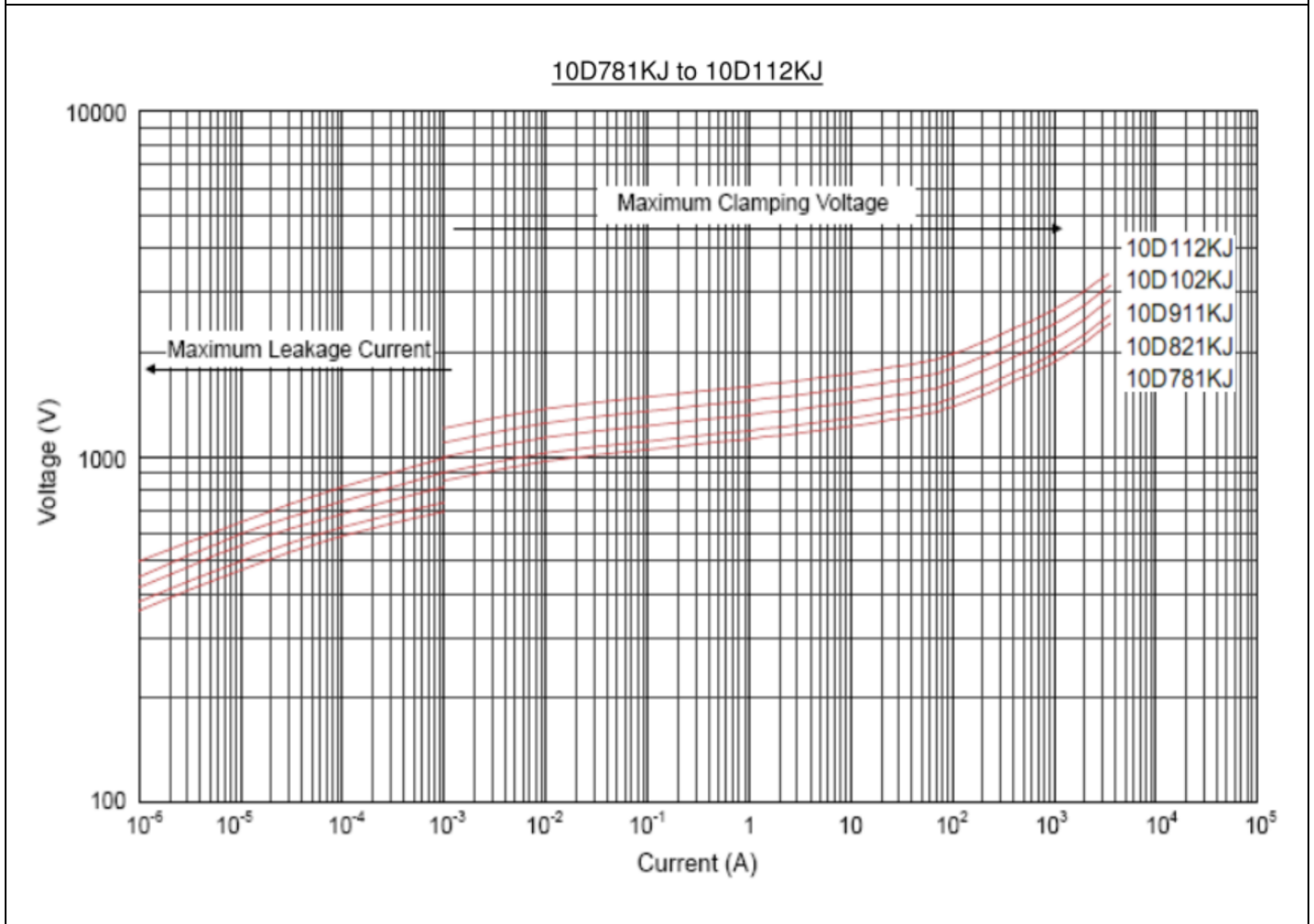
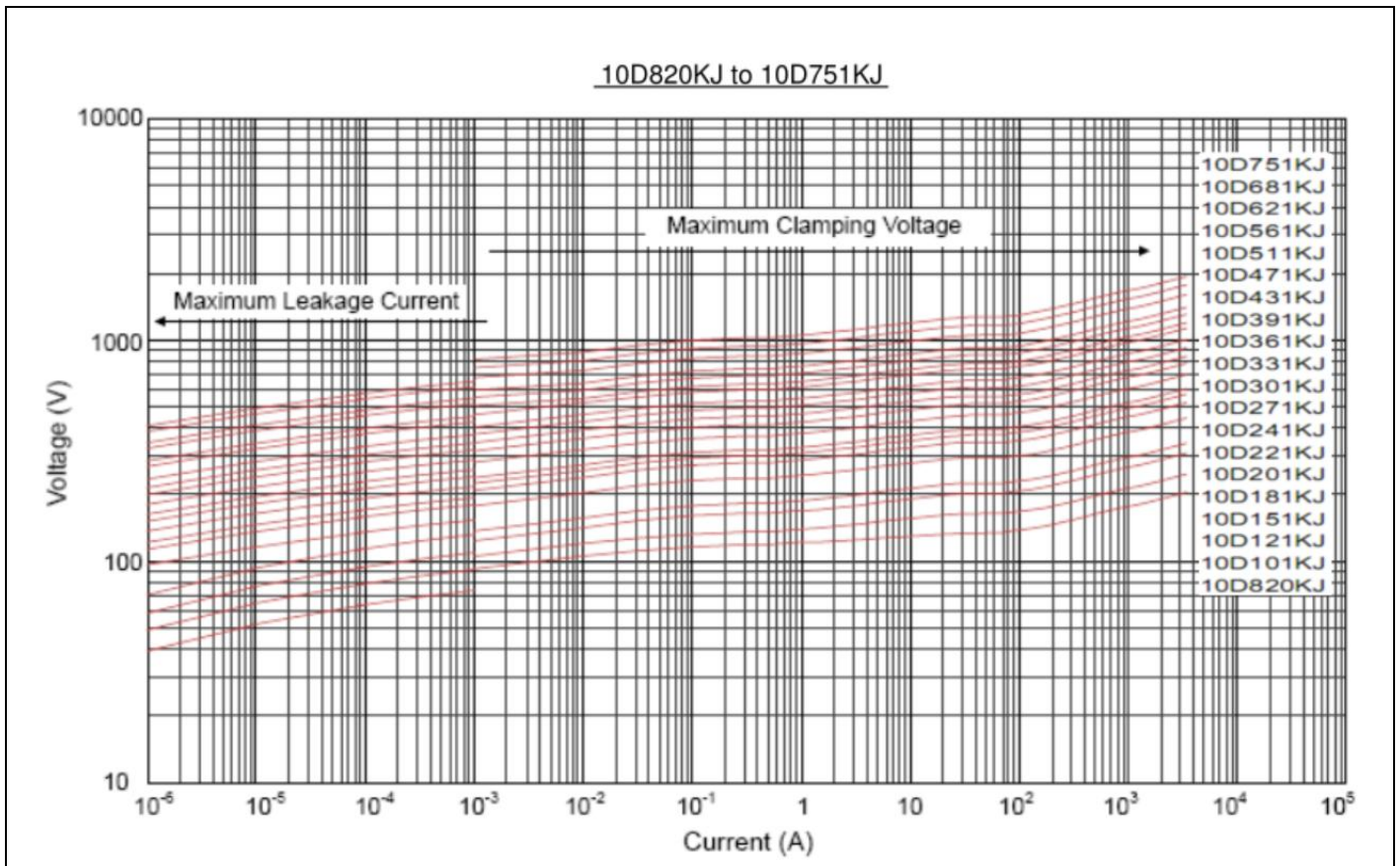

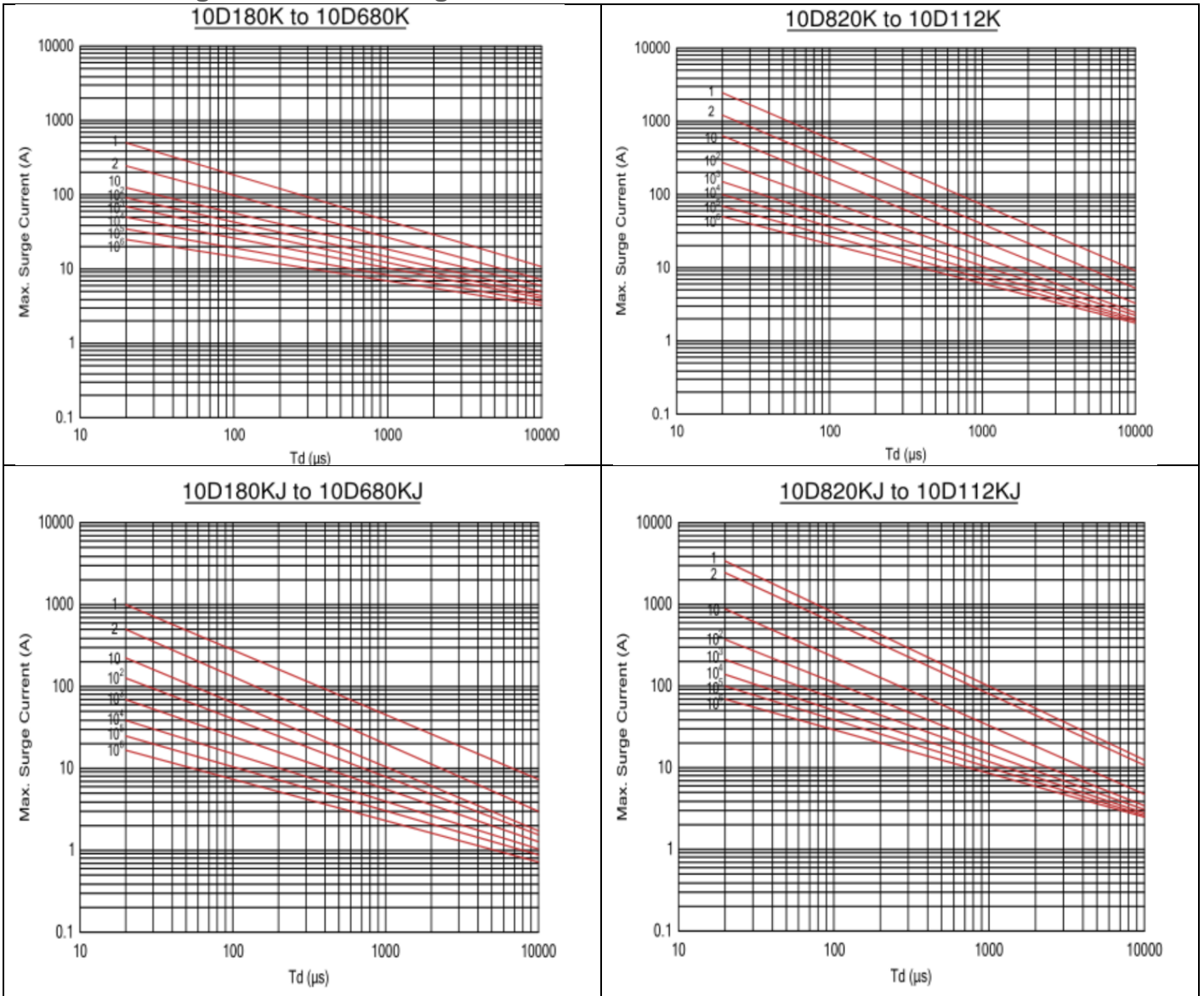

Maximum Surge Current Derating Curve

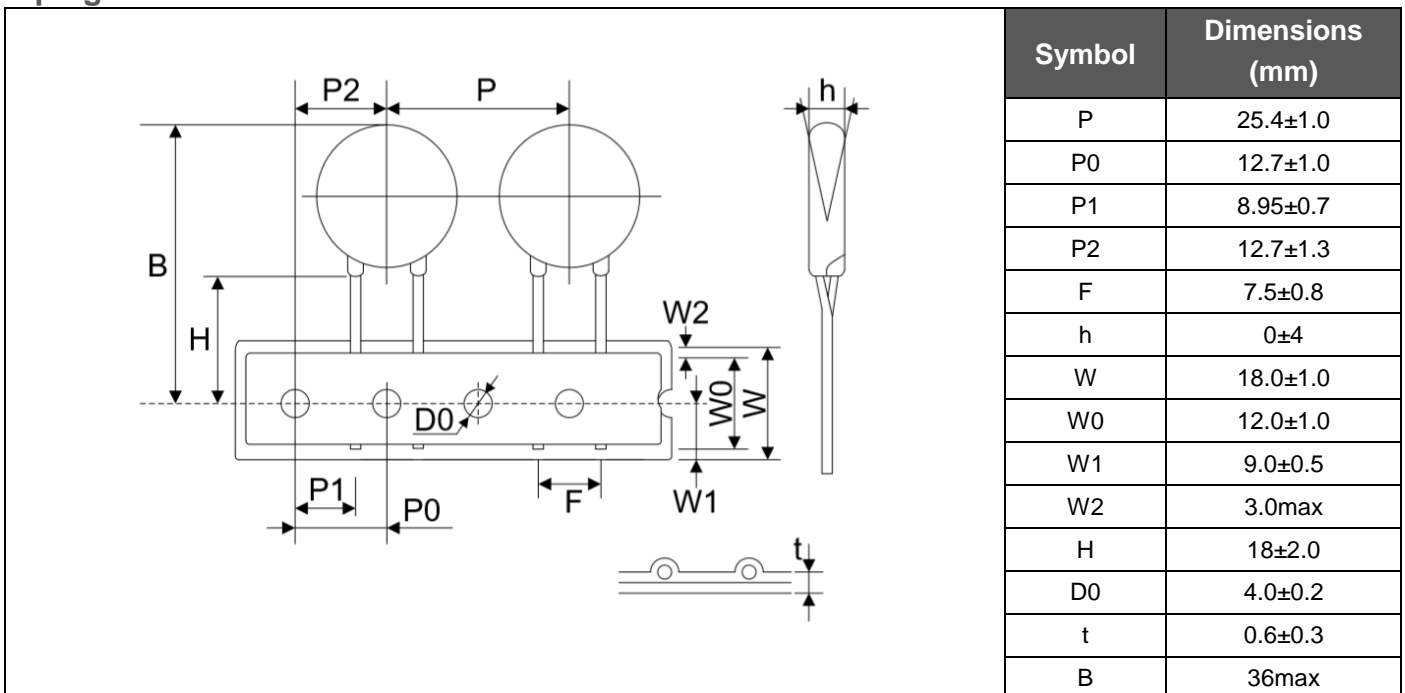

Taping Dimensions

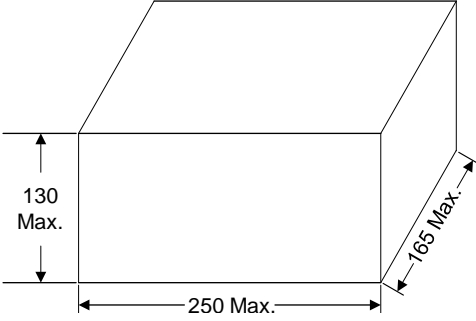

Quantity

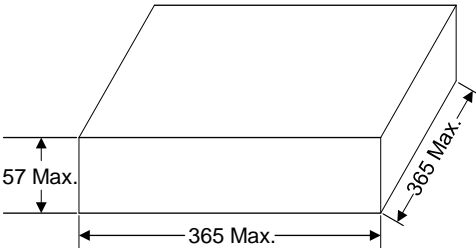
| Packaging Dimensions (Unit: mm) | Quantity | |
|---|----------------------------|-----------|
| <p>In bulk for Terminals Untrimmed Products</p>  | 500pcs/bag (180K~621K) | 4bags/box |
| | 400pcs/bag (681k~112K) | |
| <p>In bulk for Terminals Trimmed Products</p>  | 500pcs/bag (180K~621K) | 4bags/box |
| | 400pcs/bag (681k~112K) | |
| <p>Tape & Box</p>  | 750pcs/bag (180K~391K) | 6bags/box |
| | 500pcs/bag (431K~621K) | |
| | 300pcs/bag (681K~112K) | |
| <p>Tape & Reel</p>  | 1000pcs/bag (180K~391K) | 6bags/box |
| | 750pcs/bag (431K~621K) | |
| | 500pcs/bag (681k~751K) | |
| | 400pcs/bag (781k~112K) | |

X-ON Electronics

Largest Supplier of Electrical and Electronic Components

Click to view similar products for [Varistors](#) category:

Click to view products by [FTR](#) manufacturer:

Other Similar products are found below :

[R71ZOV151HC](#) [B72205S271K111](#) [B72214S251K151](#) [NTE1V020](#) [NTE1V130](#) [25FN511K](#) [S10K11G5S5](#) [ERZ-C14DK361U](#) [ERZ-C20DK221U](#) [ERZ-C32CK201B](#) [207869-1](#) [AS-13](#) [B72214S200K551](#) [B72280B112K1](#) [B72540E 350K 62](#) [B72590D360A60](#) [B72650M301K93](#) [B72670M1140K72](#) [TVZ18EC271KBS](#) [TVZ20EB911KBS](#) [TVZ25D201KBS](#) [TVZ25D241KBS](#) [VDRH20X230BSE](#) [VZ07D220KBS](#) [VZ40D241KQ-N](#) [VZ40D241K](#) [VZ25D511KBS-N](#) [VZ20E511KBSX](#) [VZ20E221KBSX](#) [VZ10D471KBS-N](#) [ERZ-V20R221](#) [20A9FN241K](#) [B72205S350K211](#) [B72214S110K551](#) [B72510E140K62](#) [B72650M151K93](#) [B72650M350K72](#) [TVZ25DN271KBS](#) [TVZ25D301KBS](#) [TVZ20EC911KBS](#) [TVZ20EBN911KBS](#) [TVZ18EC471KBS](#) [B72220S350K101](#) [B72540E300K62](#) [TND10V-271KB00AAA0](#) [NTE1V030](#) [NTE1V275](#) [NTE2V015](#) [NTE2V035](#) [NTE2V115](#)