

Metal Oxide Varistors (MOV) Data Sheet

Features

- Fast responding to transient over-voltage
- Large absorbing transient energy capability
- Low clamping ratio and no follow-on current
- Meets MSL level 1, per J-STD-020
- Operating Temperature: -40°C ~ +105°C & -40°C ~ +125°C
- Storage Temperature: -40°C ~ +125°C
- Agency recognition: UL 1449 4th /cUL/TUV/VDE/CQC

Applications

- Power supply, Telecommunication, Smart meter, or PLC protection
- Surge protection in consumer electronics
- Surge protection in industrial electronics
- Surge protection in electronic home appliances, gas and petroleum appliances
- Relay and electromagnetic valve surge absorption

Part Number Code

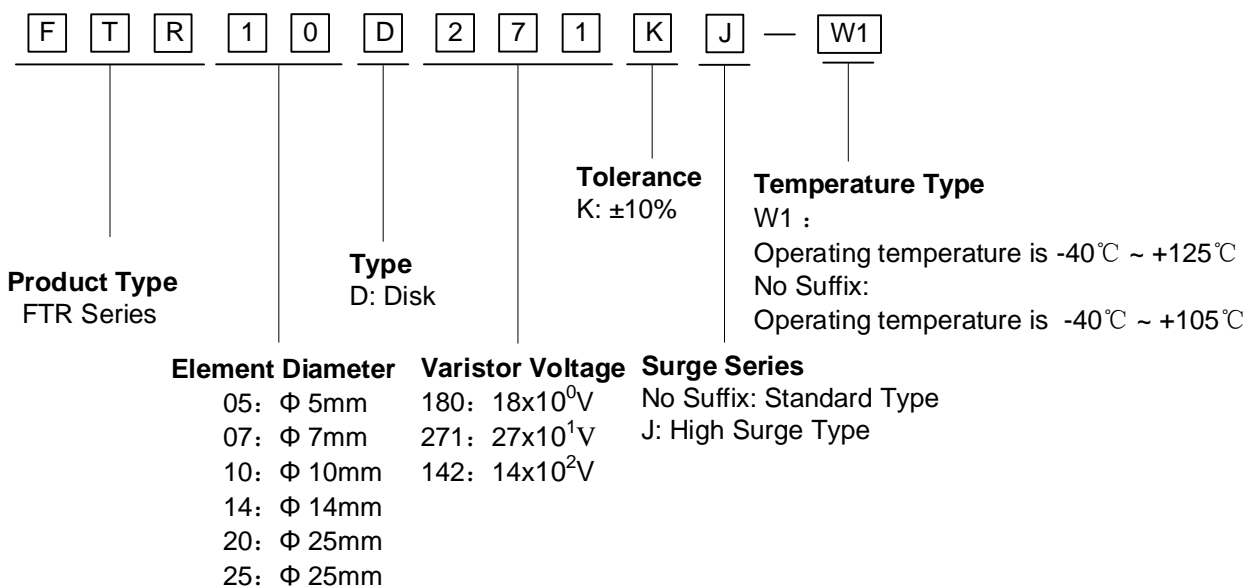

Electrical Characteristics

Part Number		Maximum Allowable Voltage		Varistor Voltage	Maximum Clamping Voltage		Withstanding Surge current		Maximum Energy (10/1000μs)		Rated Power	Dimension T _{max}
Standard	High Surge	V _{AC} (V)	V _{DC} (V)	V _{1mA} (V)	I _P (A)	V _C (V)	(A) Standard	(A) High Surge	(J) Standard	(J) High Surge	(W)	(mm)
FTR10D180K	FTR10D180KJ	11	14	18(15~21.6)	5	36	500	1000	2.1	3	0.05	5.0
FTR10D220K	FTR10D220KJ	14	18	22(19.5~26)	5	43	500	1000	2.5	5	0.05	5.0
FTR10D270K	FTR10D270KJ	17	22	27(24~31)	5	53	500	1000	3	6	0.05	5.0
FTR10D330K	FTR10D330KJ	20	26	33(29.5~36.5)	5	65	500	1000	4	7	0.05	5.0
FTR10D390K	FTR10D390KJ	25	31	39(35~43)	5	77	500	1000	4.6	9	0.05	5.0
FTR10D470K	FTR10D470KJ	30	38	47(42~52)	5	93	500	1000	5.5	11	0.05	5.0
FTR10D560K	FTR10D560KJ	35	45	56(50~62)	5	110	500	1000	7	13	0.05	5.0
FTR10D680K	FTR10D680KJ	40	56	68(61~75)	5	135	500	1000	8.2	15	0.05	5.0
FTR10D820K	FTR10D820KJ	50	65	82(74~90)	25	135	2500	3500	12	17	0.4	5.0
FTR10D101K	FTR10D101KJ	60	85	100(90~110)	25	165	2500	3500	15	18	0.4	4.2
FTR10D121K	FTR10D121KJ	75	100	120(108~132)	25	200	2500	3500	18	21	0.4	4.4
FTR10D151K	FTR10D151KJ	95	125	150(135~165)	25	250	2500	3500	22	25	0.4	4.0
FTR10D181K	FTR10D181KJ	115	150	180(162~198)	25	300	2500	3500	27	30	0.4	4.1
FTR10D201K	FTR10D201KJ	130	170	200(180~220)	25	340	2500	3500	30	35	0.4	4.2
FTR10D221K	FTR10D221KJ	140	180	220(198~242)	25	360	2500	3500	32	39	0.4	4.3
FTR10D241K	FTR10D241KJ	150	200	240(216~264)	25	395	2500	3500	35	42	0.4	4.4
FTR10D271K	FTR10D271KJ	175	225	270(243~297)	25	455	2500	3500	37	49	0.4	4.6
FTR10D301K	FTR10D301KJ	190	250	300(270~330)	25	500	2500	3500	40	54	0.4	4.7
FTR10D331K	FTR10D331KJ	210	275	330(297~363)	25	550	2500	3500	43	58	0.4	4.7
FTR10D361K	FTR10D361KJ	230	300	360(324~396)	25	595	2500	3500	47	65	0.4	4.9
FTR10D391K	FTR10D391KJ	250	320	390(351~429)	25	650	2500	3500	60	70	0.4	5.0
FTR10D431K	FTR10D431KJ	275	350	430(387~473)	25	710	2500	3500	65	80	0.4	5.2
FTR10D471K	FTR10D471KJ	300	385	470(423~517)	25	775	2500	3500	67	85	0.4	5.4
FTR10D511K	FTR10D511KJ	320	415	510(459~561)	25	845	2500	3500	69	90	0.4	5.6
FTR10D561K	FTR10D561KJ	350	460	560(504~616)	25	925	2500	3500	70	92	0.4	5.8
FTR10D621K	FTR10D621KJ	385	505	620(558~682)	25	1025	2500	3500	72	95	0.4	6.1
FTR10D681K	FTR10D681KJ	420	560	680(612~748)	25	1120	2500	3500	75	98	0.4	6.4
FTR10D751K	FTR10D751KJ	460	615	750(675~825)	25	1240	2500	3500	77	100	0.4	6.5
FTR10D781K	FTR10D781KJ	485	640	780(702~858)	25	1290	2500	3500	80	105	0.4	6.6
FTR10D821K	FTR10D821KJ	510	670	820(738~902)	25	1355	2500	3500	85	110	0.4	6.8
FTR10D911K	FTR10D911KJ	550	745	910(819~1001)	25	1500	2500	3500	93	130	0.4	7.2
FTR10D102K	FTR10D102KJ	625	825	1000(900~1100)	25	1650	2500	3500	102	140	0.4	7.2
FTR10D112K	FTR10D112KJ	680	895	1100(990~1210)	25	1815	2500	3500	115	155	0.4	7.6

Notes: 1. The tolerance of varistor voltage between 18V and 27V is more than 10%.

2. Leakage Current (@83% of V_{1mA}): IR ≤ 50μ A (180K~680K) ; IR ≤ 25μ A (820K~112K)

Dimensions

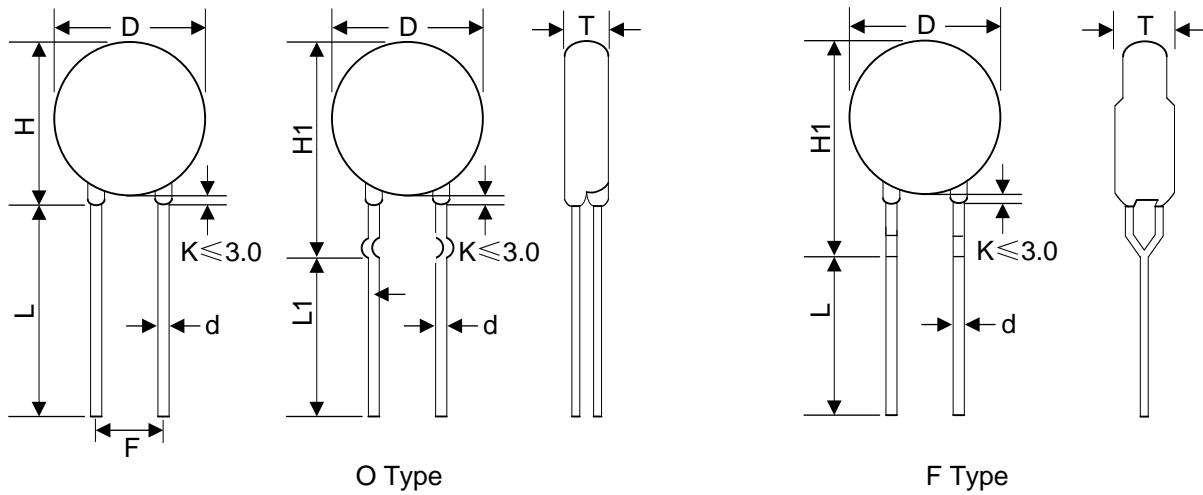

O Type

F Type

Symbol	H(max.)	H1(Max.)	L(min.)	L1(min.)	D (max.)	F(±0.8)	d(±0.05)	Tmax
Dimension(mm)	14.5	16.5	20	15	12	7.5	0.8	Please refer to the Electrical Characteristics Table

Marking Code

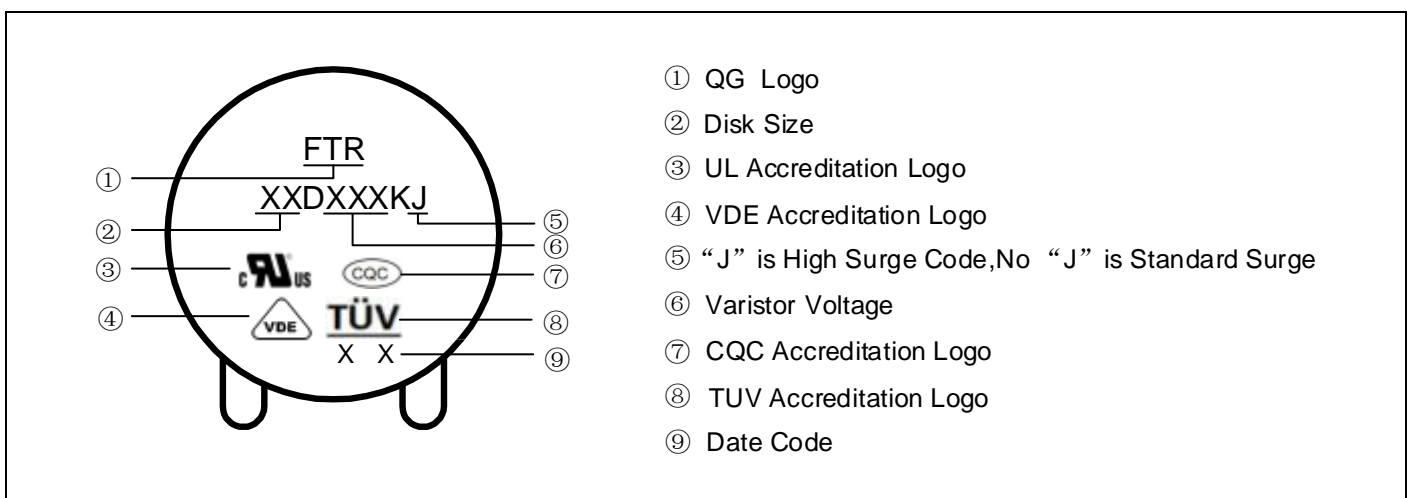

Electrical Ratings

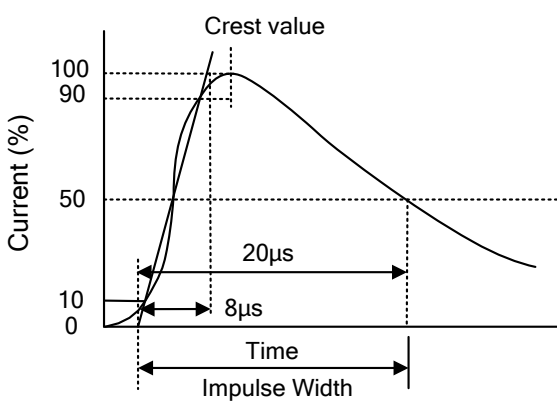
Items	Test Condition/Description	Requirement					
Varistor Voltage	The voltage between two terminals with the specified measuring current 1mA.DC applied is called Vb.	To meet the Specified value					
Maximum Allowable Voltage	The recommended maximum sine wave voltage (RMS) or the Maximum DC voltage can be applied continuously.						
Maximum Clamping Voltage	<p>The maximum voltage between two terminals with the specification standard impulse current. Applied waveform: 8/20μs</p> 						
Rated Wattage	The maximum average power that can be applied within the specified ambient temperature.						
Energy	The maximum energy within the varistor voltage change of ±10% when one impulse of 10/1000μs or 2ms is applied.						
Withstanding Surge Current	The maximum current within the varistor voltage change of ±10% with the standard impulse current (8/20μs) applied one time.						
Varistor Voltage Temp. Coefficient	$\left \frac{V_{1mA@85^{\circ}C} - V_{1mA@25^{\circ}C}}{V_{1mA@25^{\circ}C}} \times \frac{1}{60} \times 100\% (\%/^{\circ}C) \right $ $\left \frac{V_{1mA@-40^{\circ}C} - V_{1mA@25^{\circ}C}}{V_{1mA@25^{\circ}C}} \times \frac{1}{65} \times 100\% (\%/^{\circ}C) \right $		≤0.05%/°C				
Surge Life	<p>The change of Vb shall be measured after the impulse listed below which is applied 10,000 times continuously with the interval of ten seconds at room temperature.</p> <table border="1" data-bbox="438 1892 1204 2016"> <tr> <td rowspan="2">10Φ series</td> <td>180K to 680K</td> <td>50A (8/20μs)</td> </tr> <tr> <td>820K to 112K</td> <td>100A (8/20μs)</td> </tr> </table>	10Φ series	180K to 680K	50A (8/20μs)	820K to 112K	100A (8/20μs)	$\frac{\Delta V_b}{V_b} \leq \pm 10\%$
10Φ series	180K to 680K		50A (8/20μs)				
	820K to 112K	100A (8/20μs)					

Mechanical Characteristics

Items	Test conditions / Methods	Specifications								
Tensile Strength of Terminals	<p>Gradually applying the force specified and keeping the unit fixed for 10±1 sec.</p> <table border="1"> <tr> <td>Terminal diameter (mm)</td> <td>Force(kg)</td> </tr> <tr> <td>0.5<d≤0.8</td> <td>1.0</td> </tr> <tr> <td>0.8<d≤1.25</td> <td>2.0</td> </tr> <tr> <td>1.25<d</td> <td>4.0</td> </tr> </table>	Terminal diameter (mm)	Force(kg)	0.5<d≤0.8	1.0	0.8<d≤1.25	2.0	1.25<d	4.0	<p>NO Visible damage Δ V1mA/V1mA ≤5%</p>
Terminal diameter (mm)	Force(kg)									
0.5<d≤0.8	1.0									
0.8<d≤1.25	2.0									
1.25<d	4.0									
Bending Strength of Terminals	<p>Hold specimen and apply the force specified below to each lead. Bend the specimen to 90°, then return to the original position. Repeat the procedure in the opposite direction.</p> <table border="1"> <tr> <td>Terminal diameter (mm)</td> <td>Force(kg)</td> </tr> <tr> <td>0.5<d≤0.8</td> <td>0.5</td> </tr> <tr> <td>0.8<d≤1.25</td> <td>1.0</td> </tr> <tr> <td>1.25<d</td> <td>2.0</td> </tr> </table>	Terminal diameter (mm)	Force(kg)	0.5<d≤0.8	0.5	0.8<d≤1.25	1.0	1.25<d	2.0	<p>NO Visible damage Δ V1mA/V1mA ≤5%</p>
Terminal diameter (mm)	Force(kg)									
0.5<d≤0.8	0.5									
0.8<d≤1.25	1.0									
1.25<d	2.0									
Vibration	<p>Frequency range: 10~55 Hz Amplitude: 0.75mm or 98m/s² Direction: 3 mutually perpendicular directions, 2hrs each.</p>	<p>NO Visible damage Δ V1mA/V1mA ≤5%</p>								
Solder ability	<p>Solder Temp: 245±5°C Dipping Time: 2±0.5 sec</p>	<p>At least 95% of terminal electrode is covered by new solder</p>								
Resistanceto Soldering Heat	<p>Solder Temp: 260±5°C Dipping Time: 10±1 sec</p>	<p>NO Visible damage Δ V1mA/V1mA ≤5%</p>								

Reliability

Items	Test conditions / Methods	Specifications															
High Temperature Storage	<p>Ambient Temp: 125±2°C Duration: 1000hrs</p>	<p> Δ V1mA/V1mA ≤5%</p>															
Low Temperature Storage	<p>Ambient Temp: -40±2°C Duration: 1000hrs</p>	<p> Δ V1mA/V1mA ≤5%</p>															
Humidity	<p>Ambient Temp: 40±2°C, 90~95% R.H. Duration: 1000hrs</p>	<p> Δ V1mA/V1mA ≤5%</p>															
Temperature Cycle	<p>The conditions shown below shall be repeated 5 cycles</p> <table border="1"> <thead> <tr> <th>Step</th> <th>Temperature (°C)</th> <th>Period (minutes)</th> </tr> </thead> <tbody> <tr> <td>1</td> <td>-40±3</td> <td>30±3</td> </tr> <tr> <td>2</td> <td>Room temperature</td> <td>15±3</td> </tr> <tr> <td>3</td> <td>125±3</td> <td>30±3</td> </tr> <tr> <td>4</td> <td>Room temperature</td> <td>15±3</td> </tr> </tbody> </table>	Step	Temperature (°C)	Period (minutes)	1	-40±3	30±3	2	Room temperature	15±3	3	125±3	30±3	4	Room temperature	15±3	<p>No visible damage ΔV1mA/V1mA ≤5%</p>
Step	Temperature (°C)	Period (minutes)															
1	-40±3	30±3															
2	Room temperature	15±3															
3	125±3	30±3															
4	Room temperature	15±3															
High Temperature Load	<p>Ambient Temp: 105±2°C Duration: 1000hrs Load: Max. Allowable Voltage In AC eara.</p>	<p> ΔV1mA/V1mA ≤5%</p>															
Damp Heat Load	<p>Ambient Temp: 40±2°C, 90~95% R.H. Duration: 1000hrs Load: Max. Allowable Voltage</p>	<p>No visible damage ΔV1mA/V1mA ≤5%</p>															
Voltage Proof	<p>Metal balls method, 2500Vac 1 min.</p>	<p>No visible damage</p>															

Soldering Recommendation

Wave Lead Free Soldering Recommendation



Item	Conditions
Peak Temperature	265°C
Dipping Time	10 seconds(max.)
Soldering	1 time

Recommendation Reworking Conditions with Soldering Iron

Item	Conditions
Temperature of Soldering Iron-tip	360°C(max.)
Soldering Time	3 seconds(max.)
Distance from Varistor	2mm (min.)

Maximum Leakage Current and Maximum Clamping Voltage Curve

10D180K to 10D680K

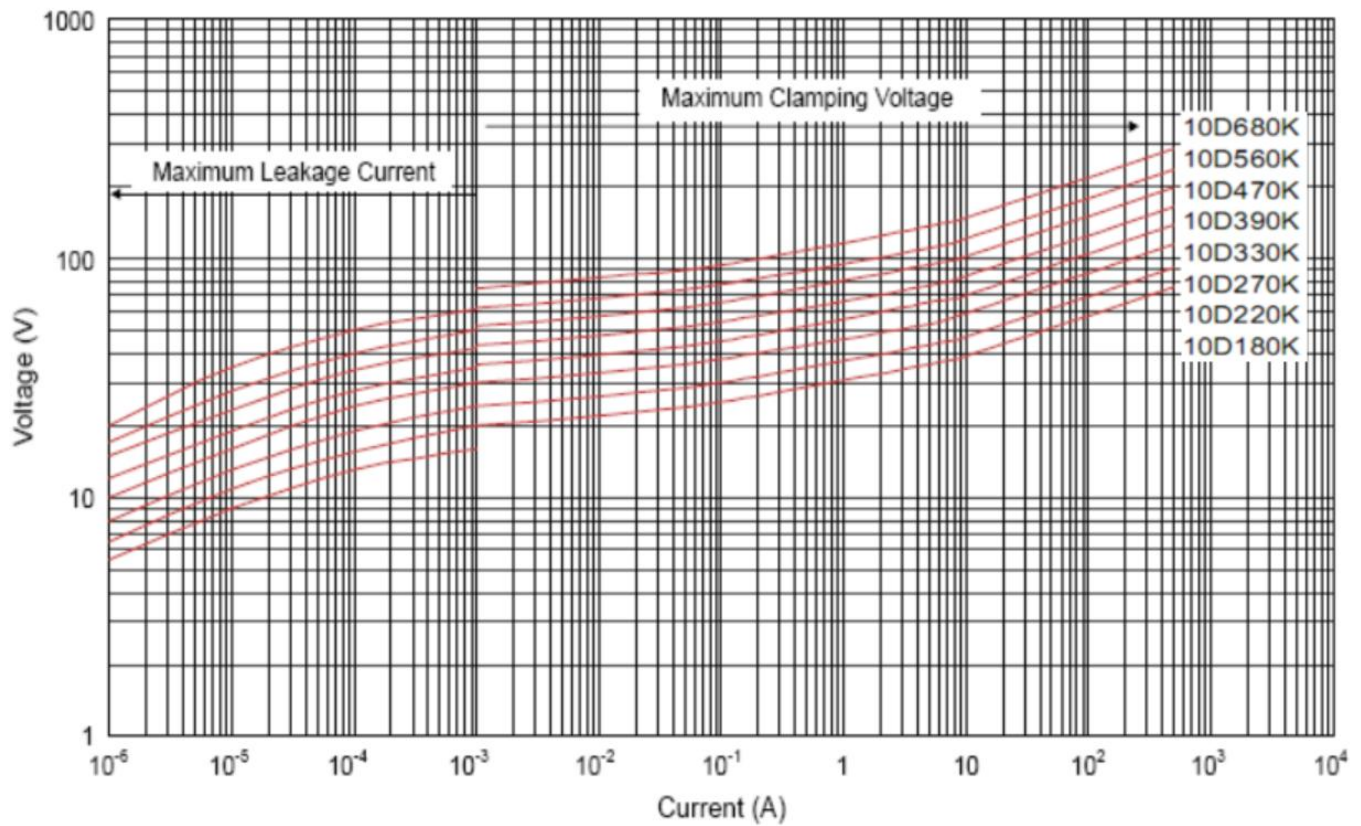

10D820K to 10D471K

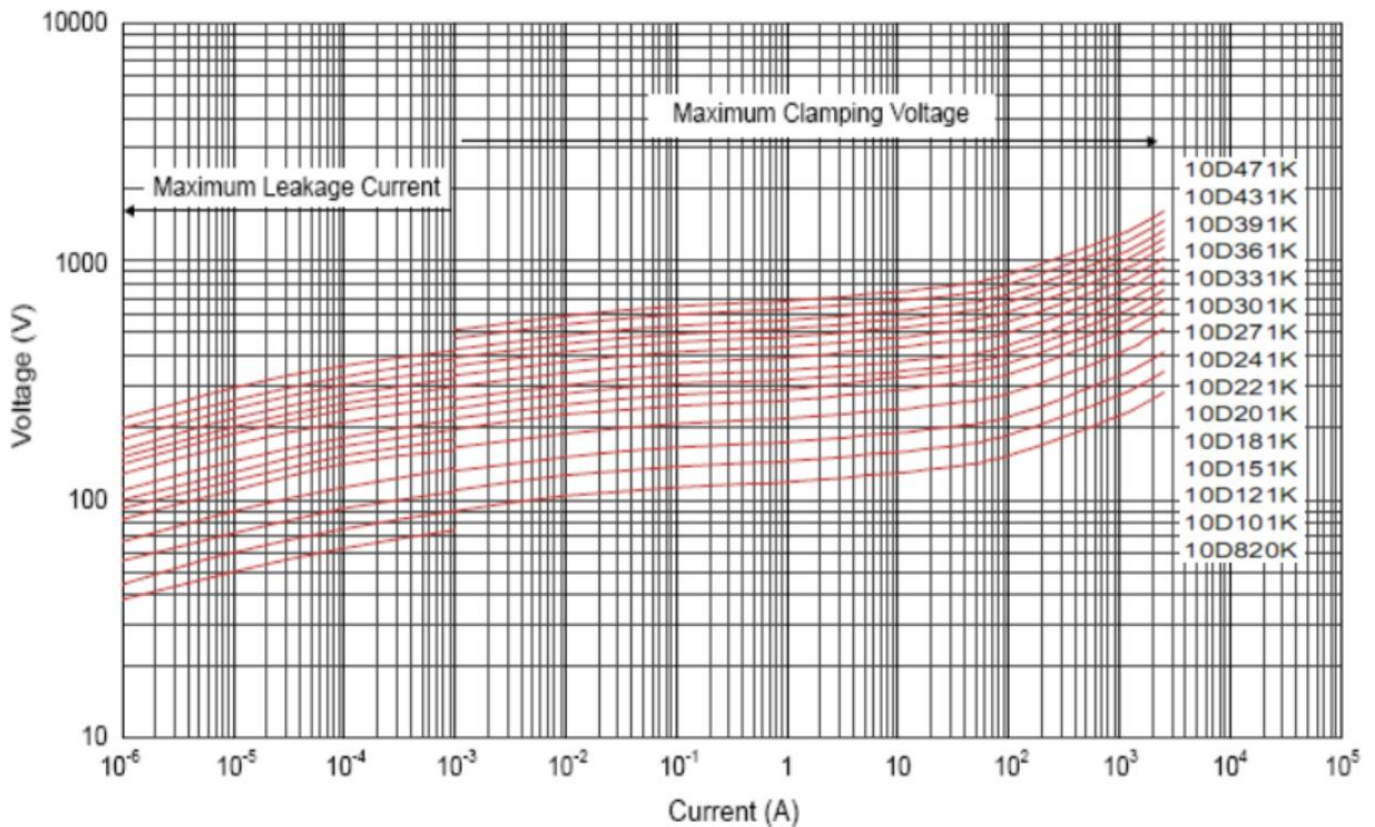

Maximum Leakage Current and Maximum Clamping Voltage Curve

10D511K to 10D112K

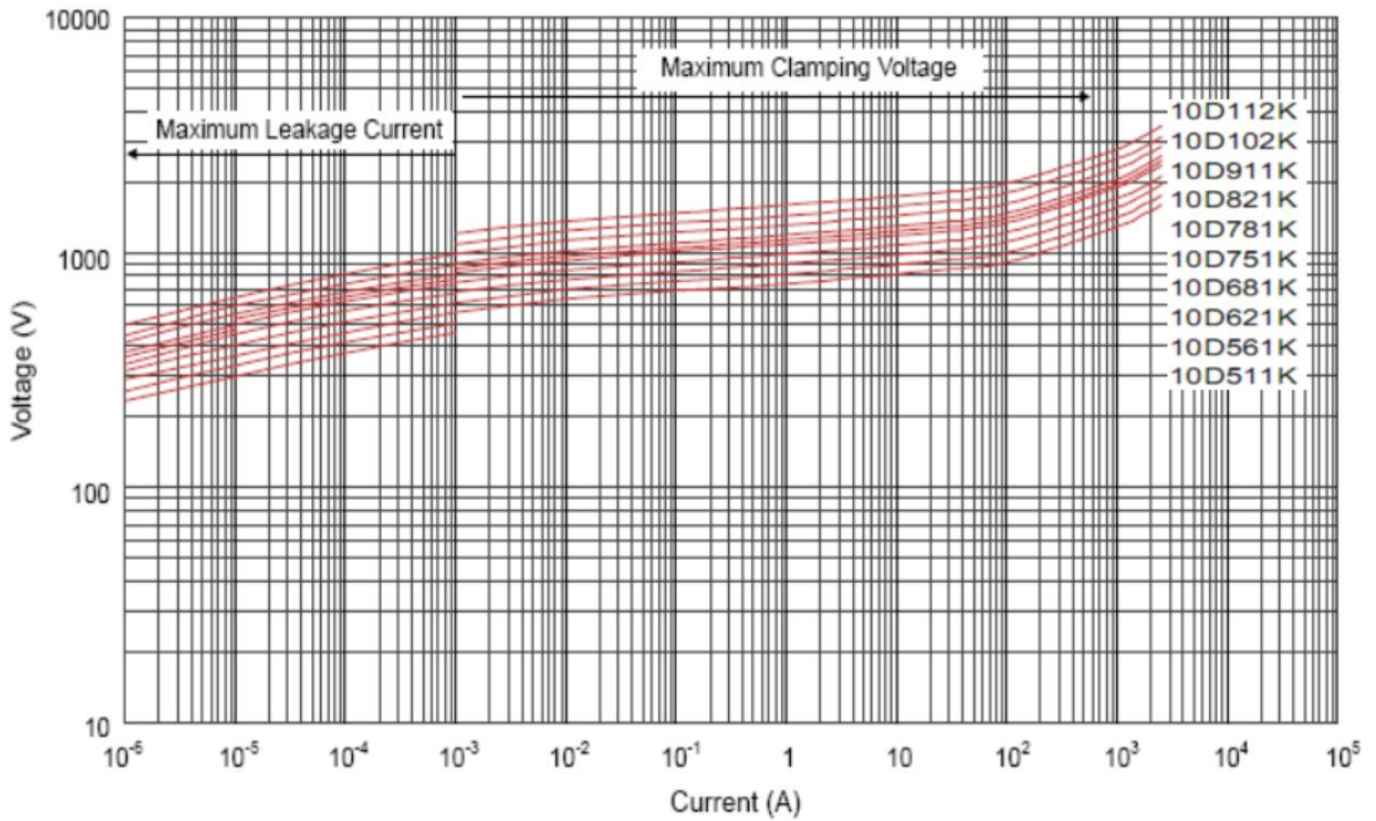

10D180KJ to 10D680KJ

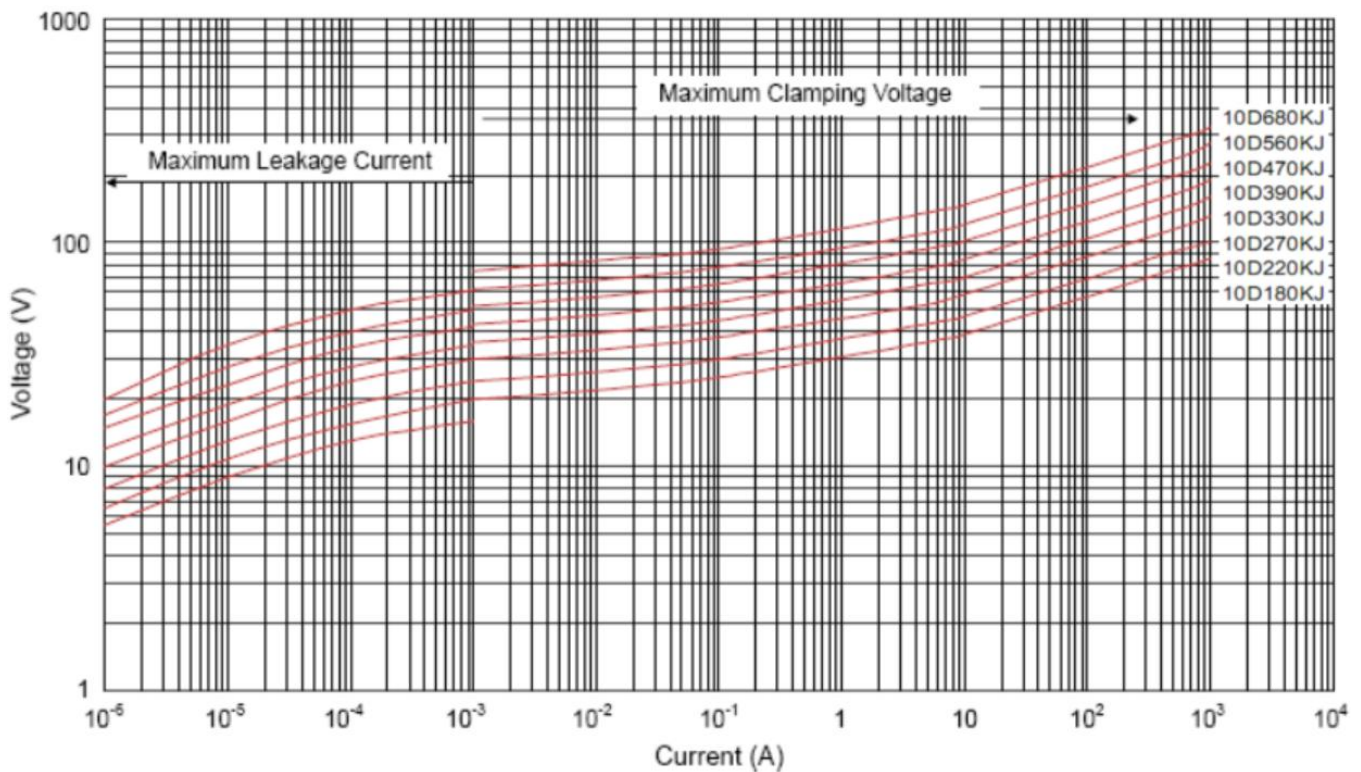

Maximum Leakage Current and Maximum Clamping Voltage Curve

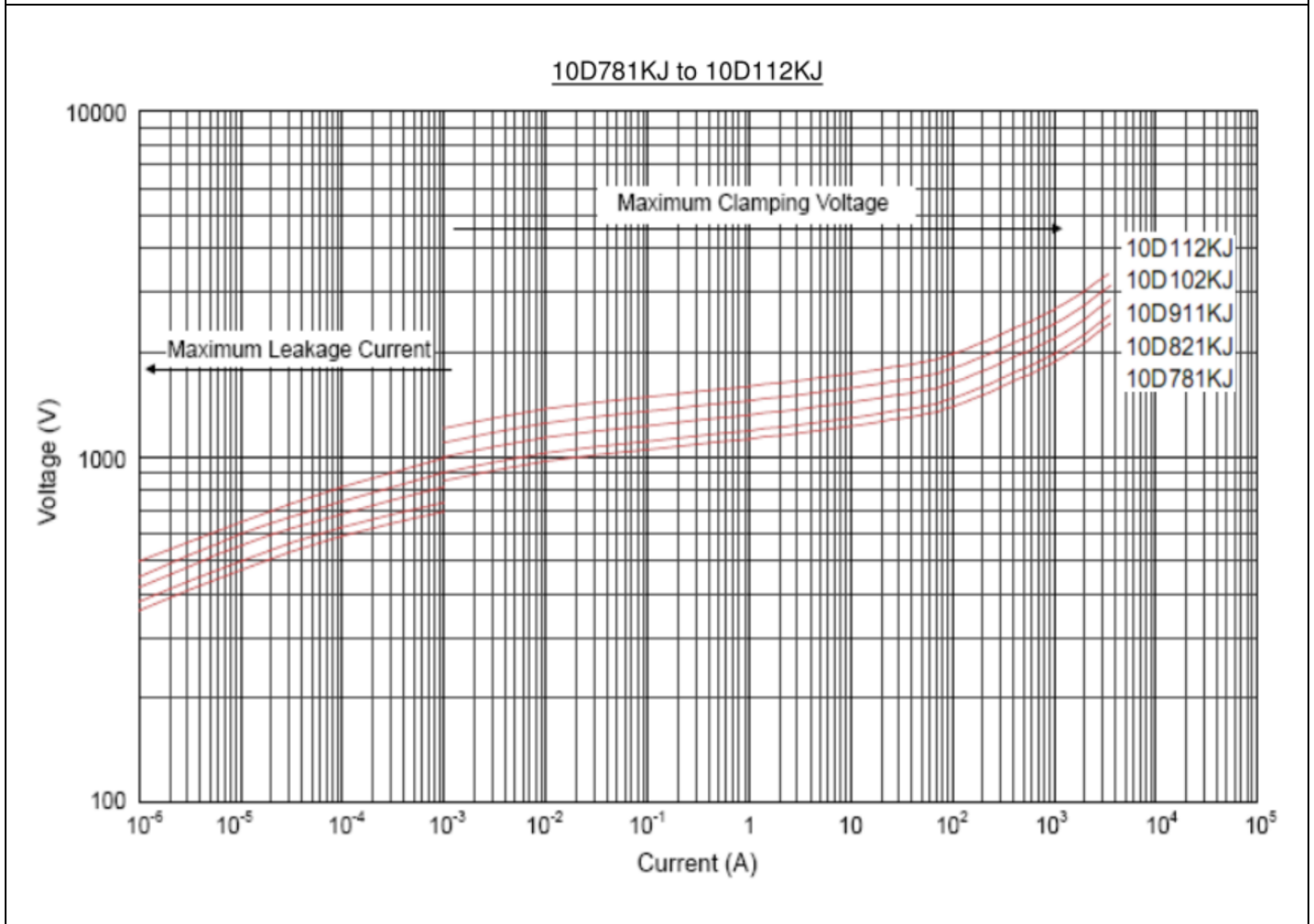
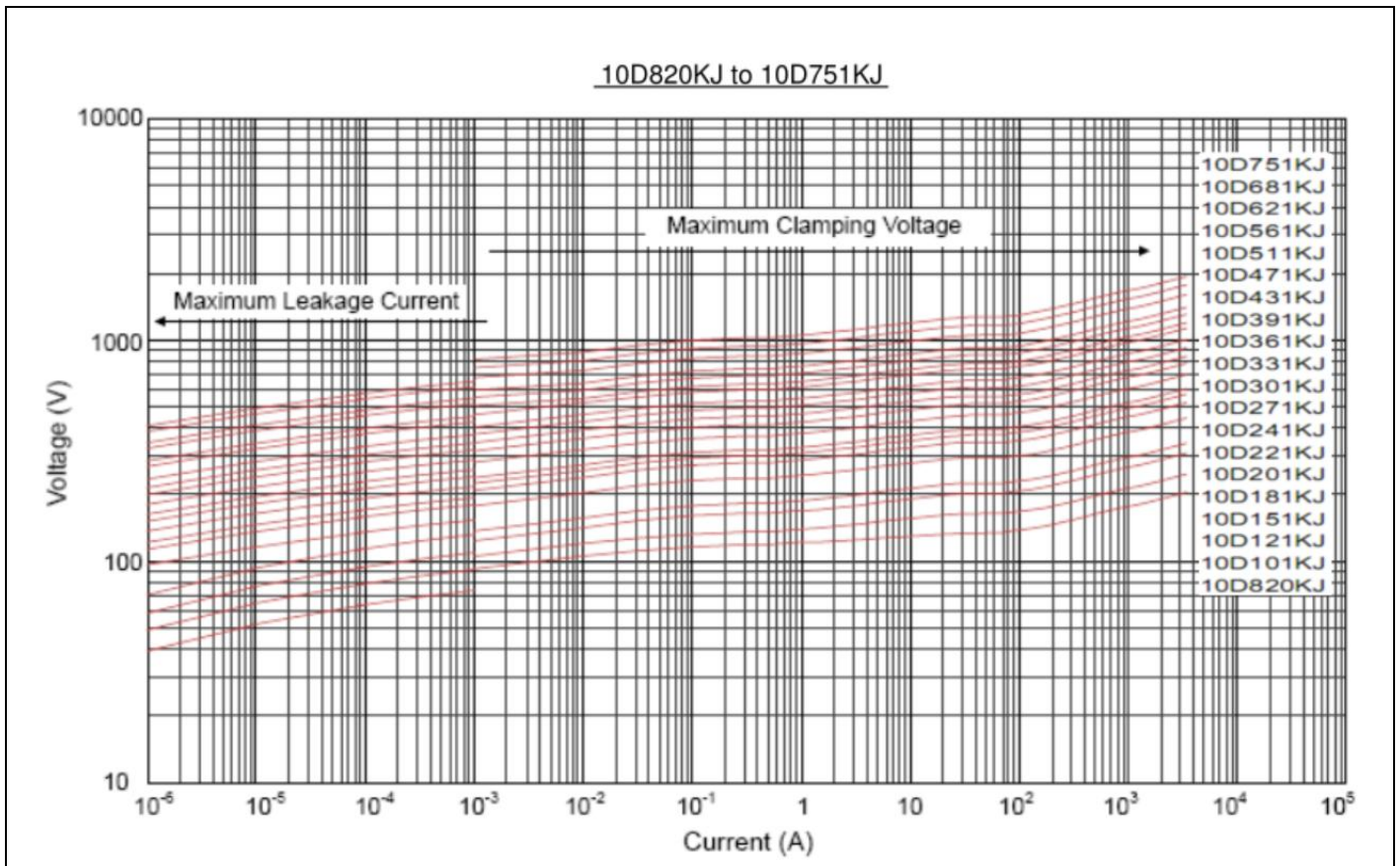

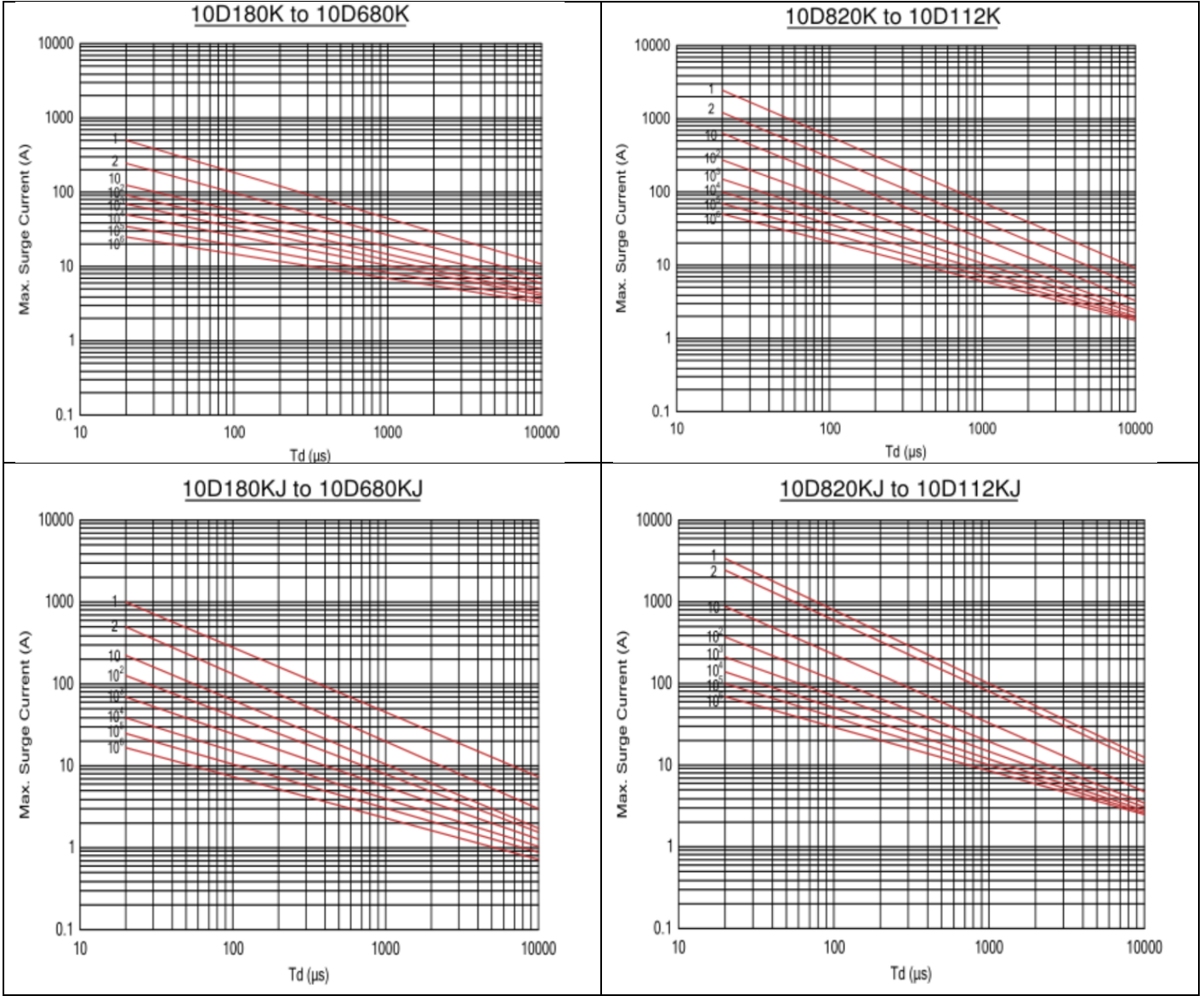

Maximum Surge Current Derating Curve

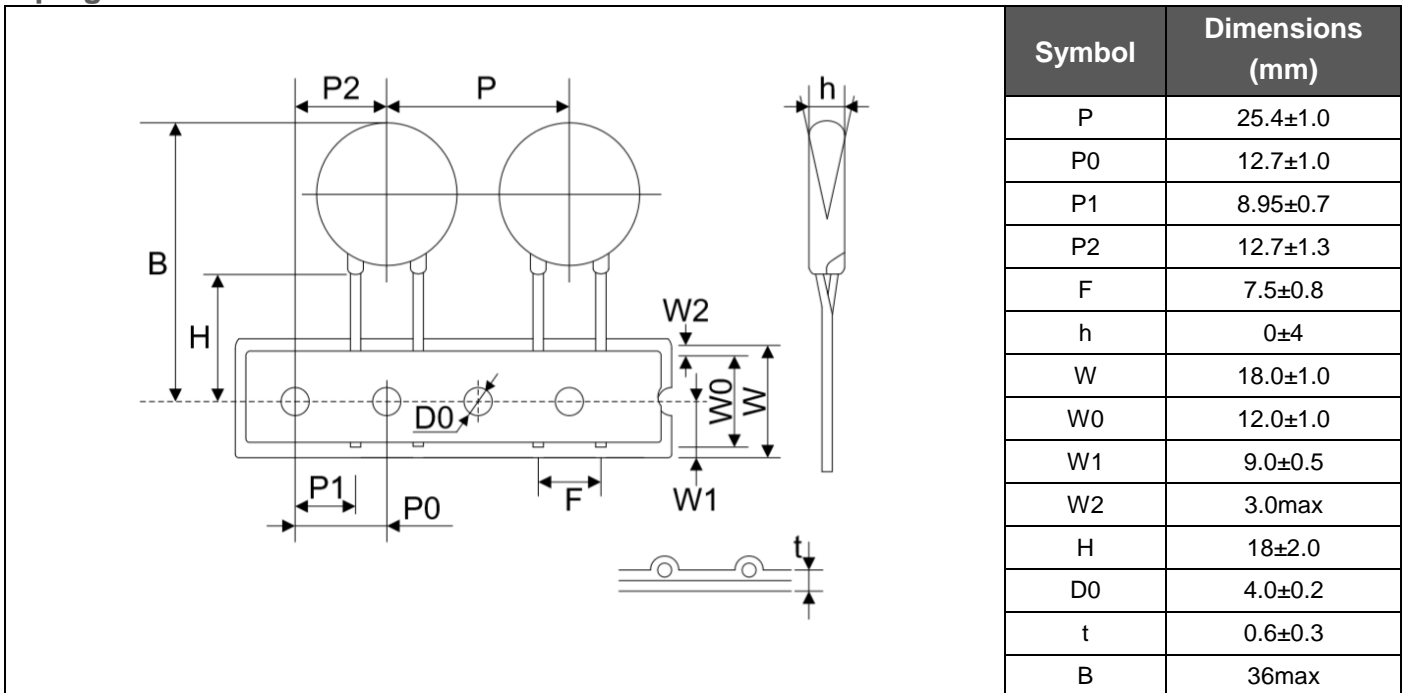

Taping Dimensions

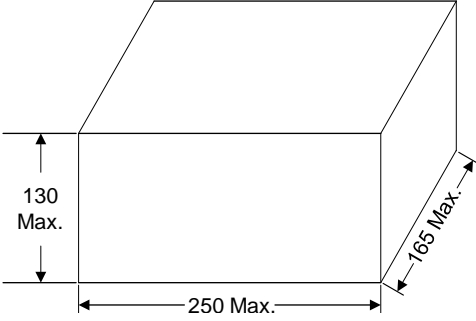

Quantity

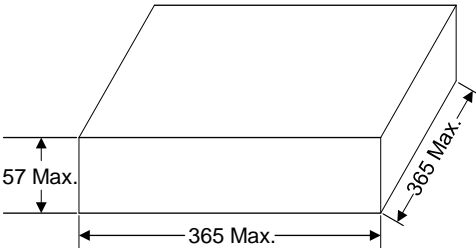
Packaging Dimensions (Unit: mm)	Quantity	
<p>In bulk for Terminals Untrimmed Products</p> 	500pcs/bag (180K~621K)	4bags/box
	400pcs/bag (681k~112K)	
<p>In bulk for Terminals Trimmed Products</p> 	500pcs/bag (180K~621K)	4bags/box
	400pcs/bag (681k~112K)	
<p>Tape & Box</p> 	750pcs/bag (180K~391K)	6bags/box
	500pcs/bag (431K~621K)	
	300pcs/bag (681K~112K)	
<p>Tape & Reel</p> 	1000pcs/bag (180K~391K)	6bags/box
	750pcs/bag (431K~621K)	
	500pcs/bag (681k~751K)	
	400pcs/bag (781k~112K)	

X-ON Electronics

Largest Supplier of Electrical and Electronic Components

Click to view similar products for [Varistors](#) category:

Click to view products by [FTR](#) manufacturer:

Other Similar products are found below :

[820443211E](#) [MLV0402E30703T](#) [MLV0603E30403T](#) [B72205S271K111](#) [B72207S350K311](#) [B72207S381K101](#) [B72260B102K1](#)
[B72260B251K1](#) [B72280B0381K001](#) [B72280B0461K001](#) [B72280B271K1](#) [B72650M0151K093](#) [B72660M0271K093](#) [S10K11G5S5](#) [ERZ-](#)
[C07DK221U](#) [TND10V-471KB00AAA0](#) [B72205S301K211](#) [B72207S141K111](#) [B72210S271K111](#) [B72214S350K551](#) [B72220P3351K101](#)
[B72280B0231K001](#) [B72280B112K1](#) [B72280B381K1](#) [B72590D360A60](#) [B72650M0400K072](#) [B72650M0500K072](#) [B72660M0200K072](#)
[B72660M1300K072](#) [B72670M1140K72](#) [MLV0603E30703T](#) [MLV0603E32503T](#) [TVZ18EC271KBS](#) [TVZ20EB911KBS](#) [TVZ25D201KBS](#)
[TVZ25D241KBS](#) [419-2080-101](#) [ERZ-V20R201](#) [MLV0805E31103T](#) [MLV0805E30703T](#) [ERZ-V20R221](#) [B72205S350K211](#)
[B72210P2511K101](#) [B72214S271K501](#) [B72220P3551K101](#) [B72240B681K1](#) [B72650M350K72](#) [TVZ20ECN511KBS](#) [TVZ20EC911KBS](#)
[TVZ20EBN911KBS](#)