

## Metal Oxide Varistors (MOV) Data Sheet

### Features

- Fast responding to transient over-voltage
- Large absorbing transient energy capability
- Low clamping ratio and no follow-on current
- Meets MSL level 1, per J-STD-020
- Operating Temperature: -40°C ~ +105°C & -40°C ~ +125°C
- Storage Temperature: -40°C ~ +125°C
- Agency recognition: UL 1449 4th /cUL/TUV/VDE/CQC

### Applications

- Power supply, Telecommunication, Smart meter, or PLC protection
- Surge protection in consumer electronics
- Surge protection in industrial electronics
- Surge protection in electronic home appliances, gas and petroleum appliances
- Relay and electromagnetic valve surge absorption

### Part Number Code

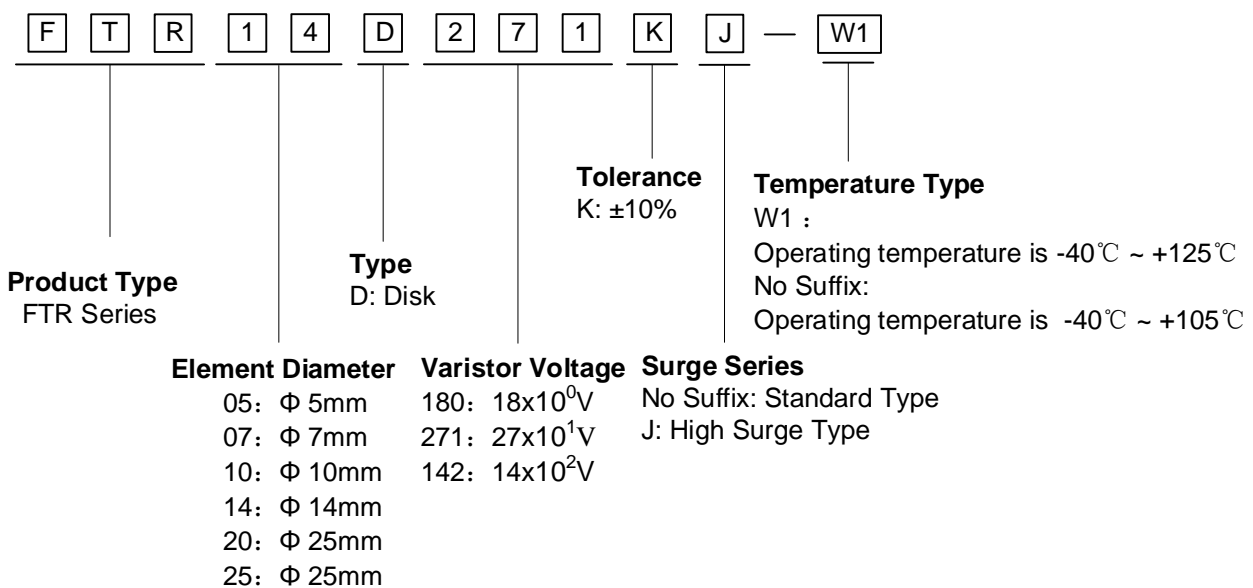

**Electrical Characteristics**

Part Number		Maximum Allowable Voltage		Varistor Voltage	Maximum Clamping Voltage		Withstanding Surge current		Maximum Energy (10/1000μs)		Rated Power	Dimension T <sub>max</sub>
Standard	High Surge	V <sub>AC</sub> (V)	V <sub>DC</sub> (V)	V <sub>1mA</sub> (V)	I <sub>P</sub> (A)	V <sub>C</sub> (V)	(A) Standard	(A) High Surge	(J) Standard	(J) High Surge	(W)	(mm)
FTR14D180K	FTR14D180KJ	11	14	18(15~21.6)	10	36	1000	2000	4	7	0.1	5.0
FTR14D220K	FTR14D220KJ	14	18	22(19.5~26)	10	43	1000	2000	5	8	0.1	5.0
FTR14D270K	FTR14D270KJ	17	22	27(24~31)	10	53	1000	2000	6	10	0.1	5.0
FTR14D330K	FTR14D330KJ	20	26	33(29.5~36.5)	10	65	1000	2000	7.5	12	0.1	5.0
FTR14D390K	FTR14D390KJ	25	31	39(35~43)	10	77	1000	2000	8.6	13	0.1	5.0
FTR14D470K	FTR14D470KJ	30	38	47(42~52)	10	93	1000	2000	10	17	0.1	5.0
FTR14D560K	FTR14D560KJ	35	45	56(50~62)	10	110	1000	2000	11	20	0.1	5.0
FTR14D680K	FTR14D680KJ	40	56	68(61~75)	10	135	1000	2000	14	24	0.1	5.0
FTR14D820K	FTR14D820KJ	50	65	82(74~90)	50	135	4500	6000	22	27	0.6	5.0
FTR14D101K	FTR14D101KJ	60	85	100(90~110)	50	165	4500	6000	28	33	0.6	4.2
FTR14D121K	FTR14D121KJ	75	100	120(108~132)	50	200	4500	6000	32	40	0.6	4.4
FTR14D151K	FTR14D151KJ	95	125	150(135~165)	50	250	4500	6000	40	53	0.6	4.0
FTR14D181K	FTR14D181KJ	115	150	180(162~198)	50	300	4500	6000	50	60	0.6	4.1
FTR14D201K	FTR14D201KJ	130	170	200(180~220)	50	340	4500	6000	57	70	0.6	4.2
FTR14D221K	FTR14D221KJ	140	180	220(198~242)	50	360	4500	6000	60	78	0.6	4.3
FTR14D241K	FTR14D241KJ	150	200	240(216~264)	50	395	4500	6000	63	84	0.6	4.4
FTR14D271K	FTR14D271KJ	175	225	270(243~297)	50	455	4500	6000	70	99	0.6	4.6
FTR14D301K	FTR14D301KJ	190	250	300(270~330)	50	500	4500	6000	77	108	0.6	4.7
FTR14D331K	FTR14D331KJ	210	275	330(297~363)	50	550	4500	6000	85	115	0.6	4.7
FTR14D361K	FTR14D361KJ	230	300	360(324~396)	50	595	4500	6000	93	130	0.6	4.9
FTR14D391K	FTR14D391KJ	250	320	390(351~429)	50	650	4500	6000	100	140	0.6	5.0
FTR14D431K	FTR14D431KJ	275	350	430(387~473)	50	710	4500	6000	115	155	0.6	5.2
FTR14D471K	FTR14D471KJ	300	385	470(423~517)	50	775	4500	6000	118	175	0.6	5.4
FTR14D511K	FTR14D511KJ	320	415	510(459~561)	50	845	4500	6000	121	180	0.6	5.6
FTR14D561K	FTR14D561KJ	350	460	560(504~616)	50	925	4500	6000	125	185	0.6	5.8
FTR14D621K	FTR14D621KJ	385	505	620(558~682)	50	1025	4500	6000	128	190	0.6	6.1
FTR14D681K	FTR14D681KJ	420	560	680(612~748)	50	1120	4500	6000	130	200	0.6	6.4
FTR14D751K	FTR14D751KJ	460	615	750(675~825)	50	1240	4500	6000	143	210	0.6	6.5
FTR14D781K	FTR14D781KJ	485	640	780(702~858)	50	1290	4500	6000	148	220	0.6	6.6
FTR14D821K	FTR14D821KJ	510	670	820(738~902)	50	1355	4500	6000	157	235	0.6	6.8
FTR14D911K	FTR14D911KJ	550	745	910(819~1001)	50	1500	4500	6000	175	255	0.6	7.1
FTR14D102K	FTR14D102KJ	625	825	1000(900~1100)	50	1650	4500	6000	190	280	0.6	7.1
FTR14D112K	FTR14D112KJ	680	895	1100(990~1210)	50	1815	4500	6000	213	310	0.6	7.6
FTR14D122K	FTR14D122KJ	750	990	1200(1080~1320)	50	1980	4500	6000	232	324	0.6	8.0
FTR14D142K	FTR14D142KJ	880	1140	1400(1260~1540)	50	2310	4500	6000	238	327	0.6	8.6

Part Number		Maximum Allowable Voltage		Varistor Voltage	Maximum Clamping Voltage		Withstanding Surge current		Maximum Energy (10/1000μs)		Rated Power	Dimension T <sub>max</sub>
Standard	High Surge	V <sub>AC</sub> (V)	V <sub>DC</sub> (V)	V <sub>1mA</sub> (V)	I <sub>P</sub> (A)	V <sub>C</sub> (V)	(A) Standard	(A) High Surge	(J) Standard	(J) High Surge	(W)	(mm)
FTR14D162K	FTR14D162KJ	1000	1280	1600(1440~1760)	50	2640	4500	6000	243	331	0.6	9.3
FTR14D182K	FTR14D182KJ	1100	1465	1800(1620~1980)	50	2970	4500	6000	250	335	0.6	10.1

- Notes: 1. The tolerance of varistor voltage between 18V and 27V is more than 10%.  
 2. Varistor voltage  $\geq 1200V$ , structure diagram is F type.  
 3. Leakage Current (@83% of V<sub>1mA</sub>):  $IR \leq 50\mu A$  (180K~680K) ;  $IR \leq 25\mu A$  (820K~182K)

### Dimensions

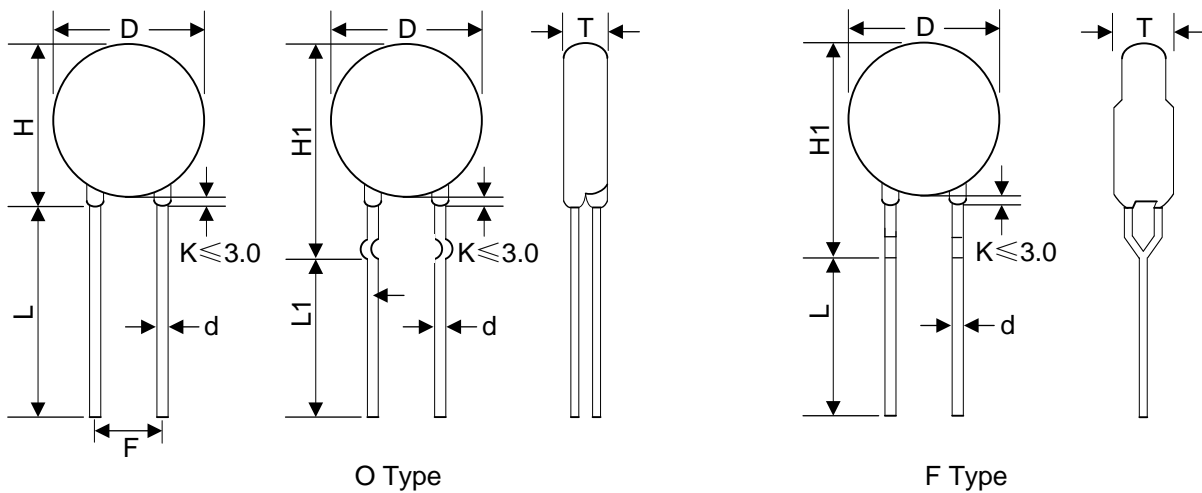

Symbol	H(max.)	H1(max.)	L(min.)	L1(min.)	D (max.)	F(±0.8)	d(±0.05)	Tmax
Dimension(mm)	19	21	20	15	16	7.5	0.8	Please refer to the Electrical Characteristics Table

### Marking Code

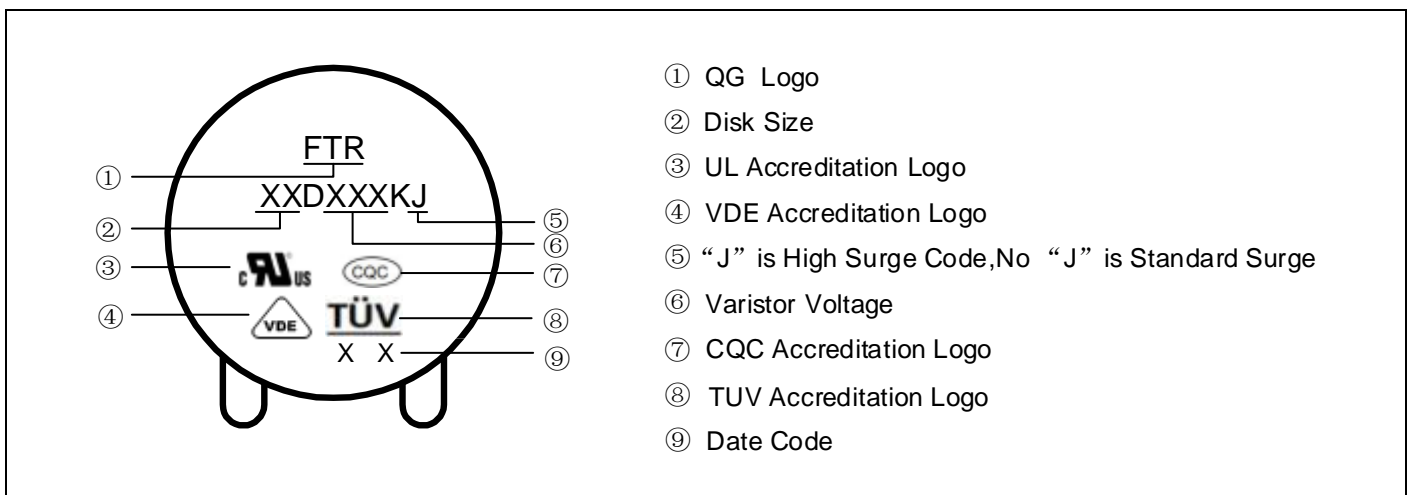

### Electrical Ratings

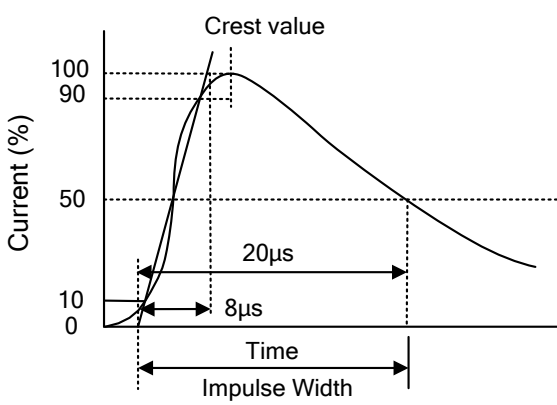
Items	Test Condition/Description	Requirement					
Varistor Voltage	The voltage between two terminals with the specified measuring current 1mA.DC applied is called Vb.	To meet the Specified value					
Maximum Allowable Voltage	The recommended maximum sine wave voltage (RMS) or the Maximum DC voltage can be applied continuously.						
Maximum Clamping Voltage	<p>The maximum voltage between two terminals with the specification standard impulse current. Applied waveform: 8/20μs</p> 						
Rated Wattage	The maximum average power that can be applied within the specified ambient temperature.						
Energy	The maximum energy within the varistor voltage change of ±10% when one impulse of 10/1000μs or 2ms is applied.						
Withstanding Surge Current	The maximum current within the varistor voltage change of ±10% with the standard impulse current (8/20μs) applied one time.						
Varistor Voltage Temp. Coefficient	$\left  \frac{V_{1mA@85^{\circ}C} - V_{1mA@25^{\circ}C}}{V_{1mA@25^{\circ}C}} \times \frac{1}{60} \times 100\% (\%/^{\circ}C) \right $ $\left  \frac{V_{1mA@-40^{\circ}C} - V_{1mA@25^{\circ}C}}{V_{1mA@25^{\circ}C}} \times \frac{1}{65} \times 100\% (\%/^{\circ}C) \right $		≤0.05%/°C				
Surge Life	<p>The change of Vb shall be measured after the impulse listed below which is applied 10,000 times continuously with the interval of ten seconds at room temperature.</p> <table border="1" data-bbox="438 1892 1204 2016"> <tr> <td rowspan="2">14Φ series</td> <td>180K to 680K</td> <td>75A (8/20μs)</td> </tr> <tr> <td>820K to 182K</td> <td>150A (8/20μs)</td> </tr> </table>	14Φ series	180K to 680K	75A (8/20μs)	820K to 182K	150A (8/20μs)	$\frac{\Delta V_b}{V_b} \leq \pm 10\%$
14Φ series	180K to 680K		75A (8/20μs)				
	820K to 182K	150A (8/20μs)					

**Mechanical Characteristics**

Items	Test conditions / Methods	Specifications
Tensile Strength of Terminals	Gradually applying the force specified and keeping the unit fixed for 10±1 sec. Terminal diameter (mm)      Froce(kg) 0.5<d≤0.8                              1.0 0.8<d≤1.25                              2.0 1.25<d                                      4.0	NO Visible damage  Δ V1mA/V1mA  ≤5%
Bending Strength of Terminals	Hold specimen and apply the force specified below to each lead. Bend the specimen to 90°, then return to the original position. Repeat the procedure in the opposite direction. Terminal diameter (mm)      Froce(kg) 0.5<d≤0.8                              0.5 0.8<d≤1.25                              1.0 1.25<d                                      2.0	NO Visible damage  Δ V1mA/V1mA  ≤5%
Vibration	Frequency range: 10~55 Hz Amplitude: 0.75mm or 98m/s <sup>2</sup> Direction: 3 mutually perpendicular directions, 2hrs each.	NO Visible damage  Δ V1mA/V1mA  ≤5%
Solder ability	Solder Temp: 245±5°C Dipping Time: 2±0.5 sec	At least 95% of terminal electrode is covered by new solder
Resistanceto Soldering Heat	Solder Temp: 260±5°C Dipping Time: 10±1 sec	NO Visible damage  Δ V1mA/V1mA  ≤5%

**Reliability**

Items	Test conditions / Methods	Specifications															
High Temperature Storage	Ambient Temp: 125±2°C Duration: 1000hrs	Δ V1mA/V1mA  ≤5%															
Low Temperature Storage	Ambient Temp: -40±2°C Duration: 1000hrs	Δ V1mA/V1mA  ≤5%															
Humidity	Ambient Temp: 40±2°C, 90~95% R.H. Duration: 1000hrs	Δ V1mA/V1mA  ≤5%															
Temperature Cycle	The conditions shown below shall be repeated 5 cycles <table border="1" style="margin-left: 40px;"> <thead> <tr> <th>Step</th> <th>Temperature (°C)</th> <th>Period (minutes)</th> </tr> </thead> <tbody> <tr> <td>1</td> <td>-40±3</td> <td>30±3</td> </tr> <tr> <td>2</td> <td>Room temperature</td> <td>15±3</td> </tr> <tr> <td>3</td> <td>125±3</td> <td>30±3</td> </tr> <tr> <td>4</td> <td>Room temperature</td> <td>15±3</td> </tr> </tbody> </table>	Step	Temperature (°C)	Period (minutes)	1	-40±3	30±3	2	Room temperature	15±3	3	125±3	30±3	4	Room temperature	15±3	No visible damage  ΔV1mA/V1mA  ≤5%
Step	Temperature (°C)	Period (minutes)															
1	-40±3	30±3															
2	Room temperature	15±3															
3	125±3	30±3															
4	Room temperature	15±3															
High Temperature Load	Ambient Temp: 105±2°C Duration: 1000hrs Load: Max. Allowable Voltage In AC eara.	ΔV1mA/V1mA  ≤5%															
Damp Heat Load	Ambient Temp: 40±2°C, 90~95% R.H. Duration: 1000hrs Load: Max. Allowable Voltage	No visible damage  ΔV1mA/V1mA  ≤5%															
Voltage Proof	Metal balls method, 2500Vac 1 min.	No visible damage															

**Soldering Recommendation**

Wave Lead Free Soldering Recommendation

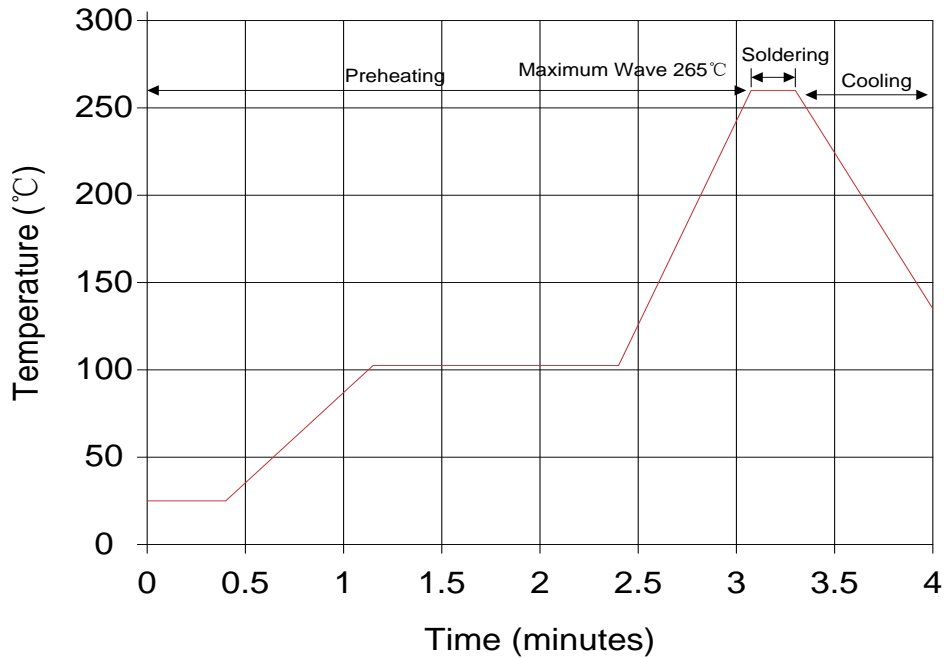

Item	Conditions
Peak Temperature	265°C
Dipping Time	10 seconds(max.)
Soldering	1 time

Recommendation Reworking Conditions with Soldering Iron

Item	Conditions
Temperature of Soldering Iron-tip	360°C(max.)
Soldering Time	3 seconds(max.)
Distance from Varistor	2mm (min.)

### Maximum Leakage Current and Maximum Clamping Voltage Curve

14D180K to 14D680K

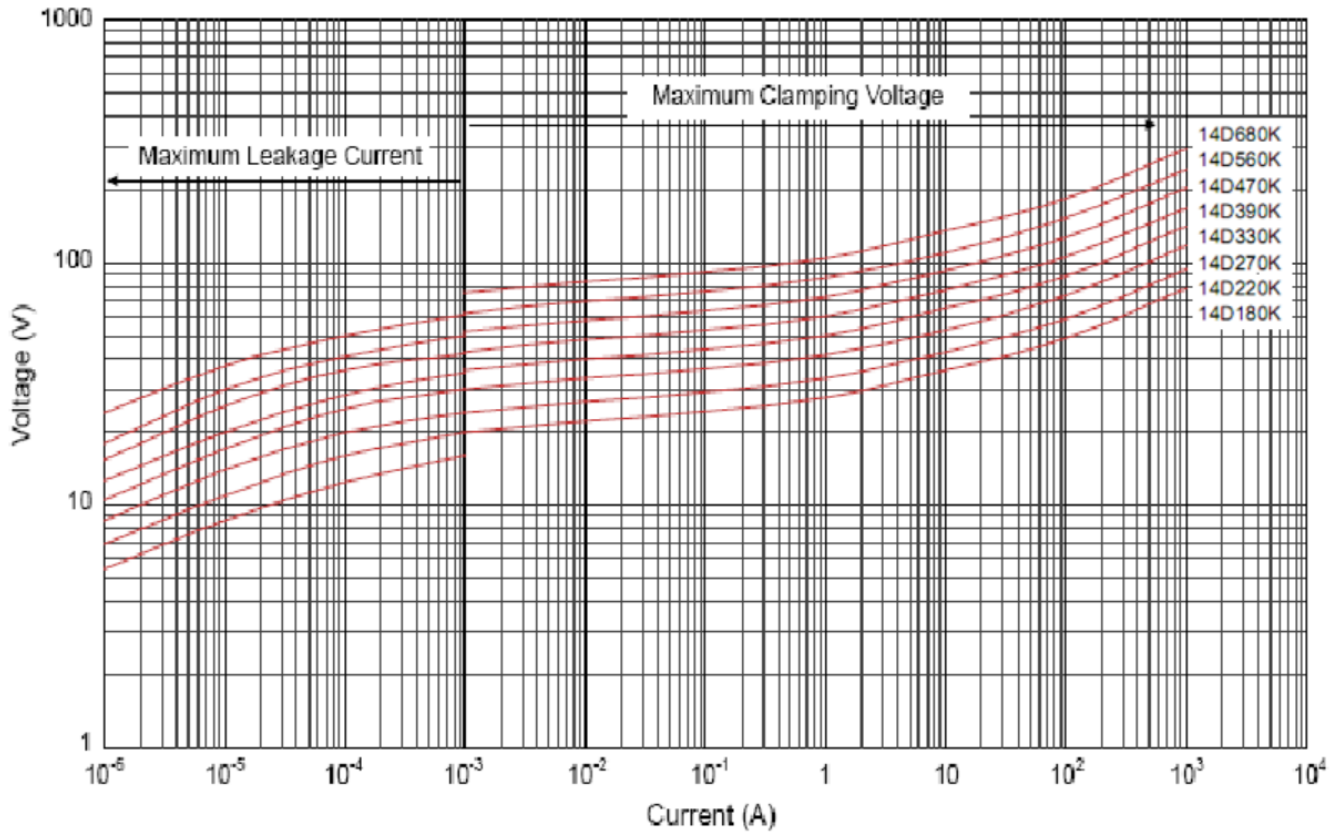

14D820K to 14D471K

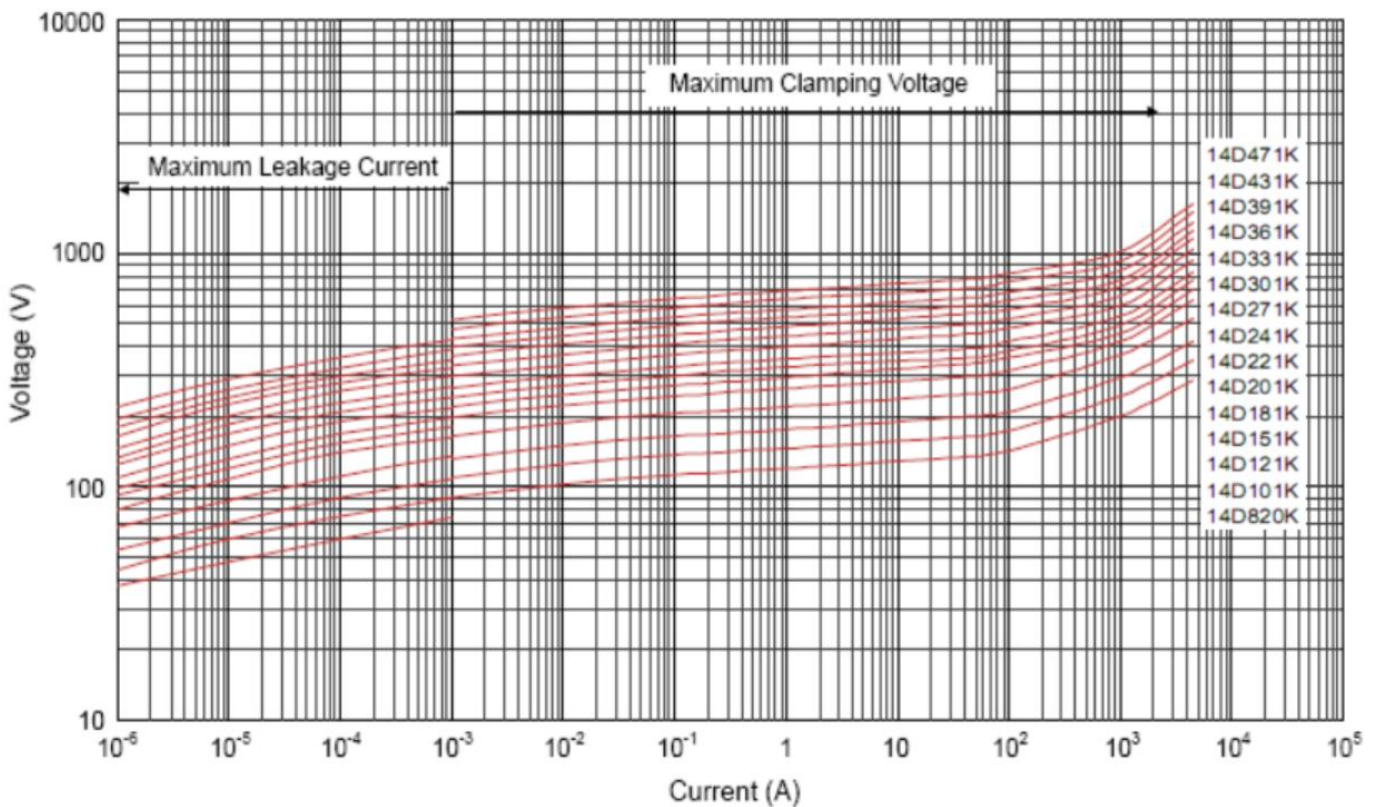

## Maximum Leakage Current and Maximum Clamping Voltage Curve

14D511K to 14D182K

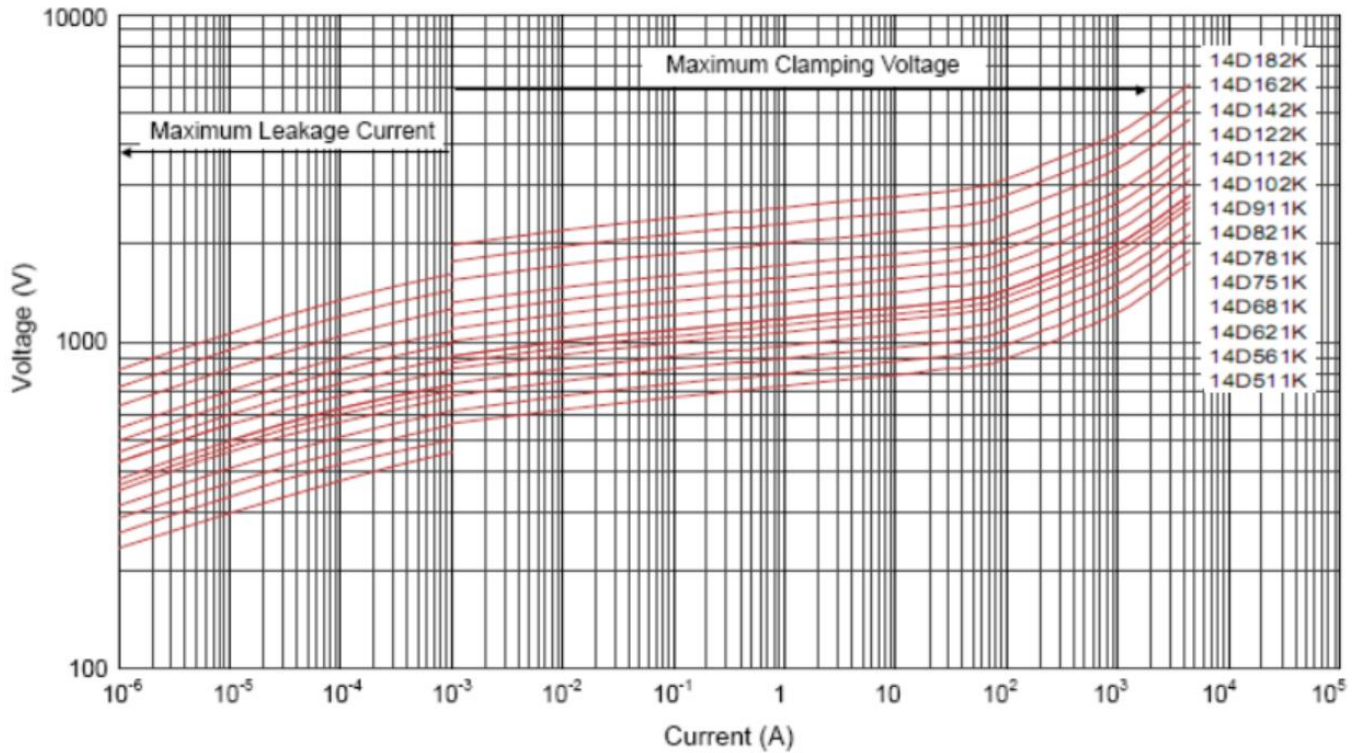

14D180KJ to 14D680KJ

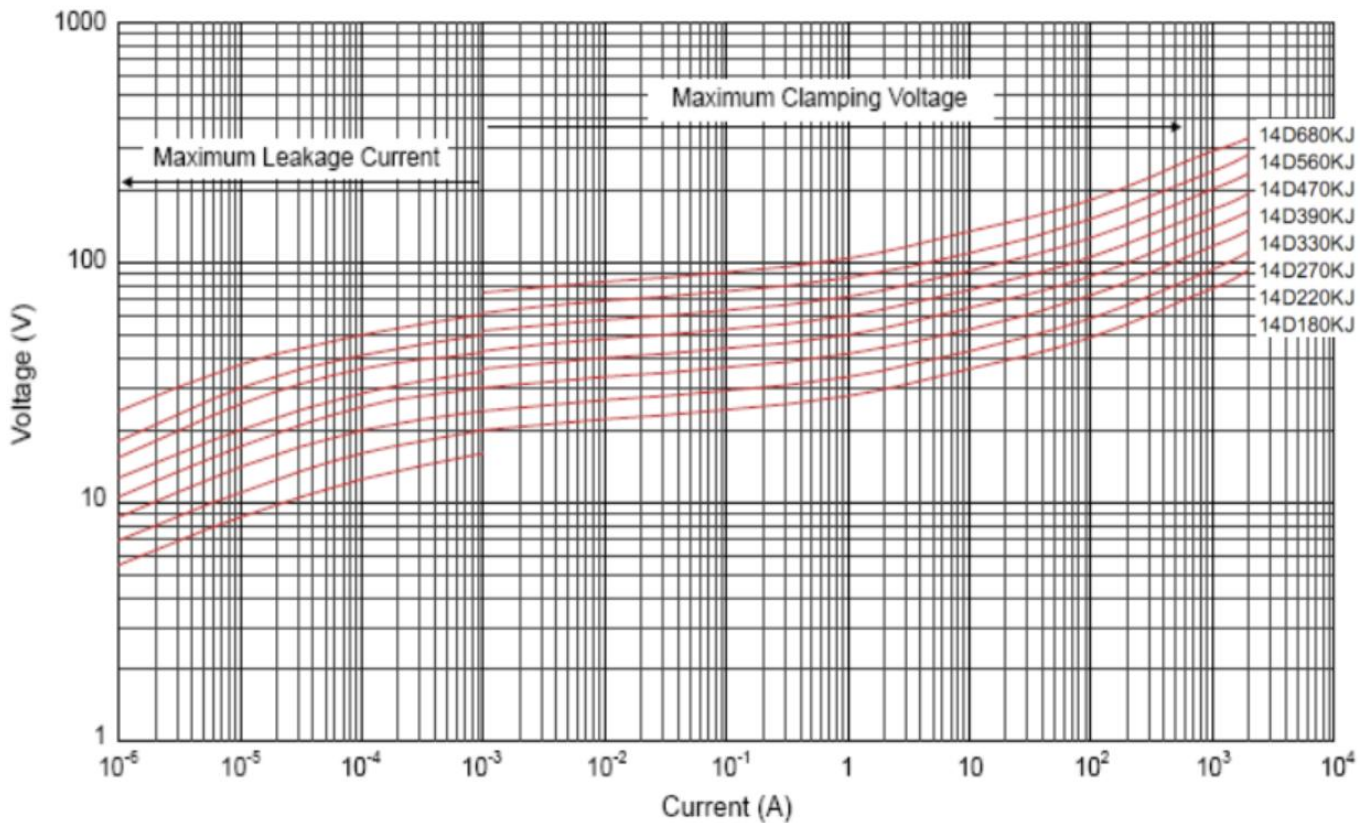



Maximum Leakage Current and Maximum Clamping Voltage Curve

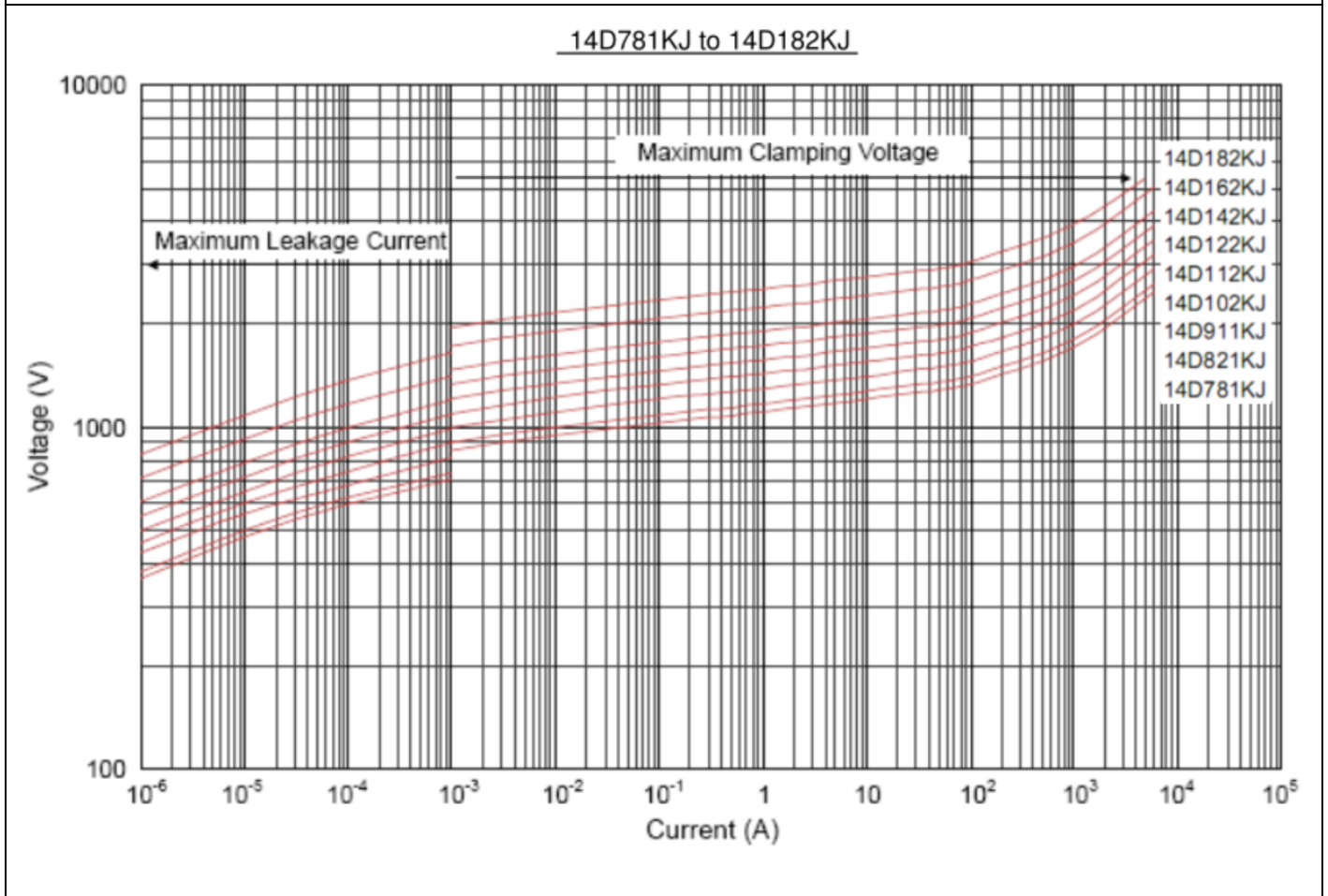
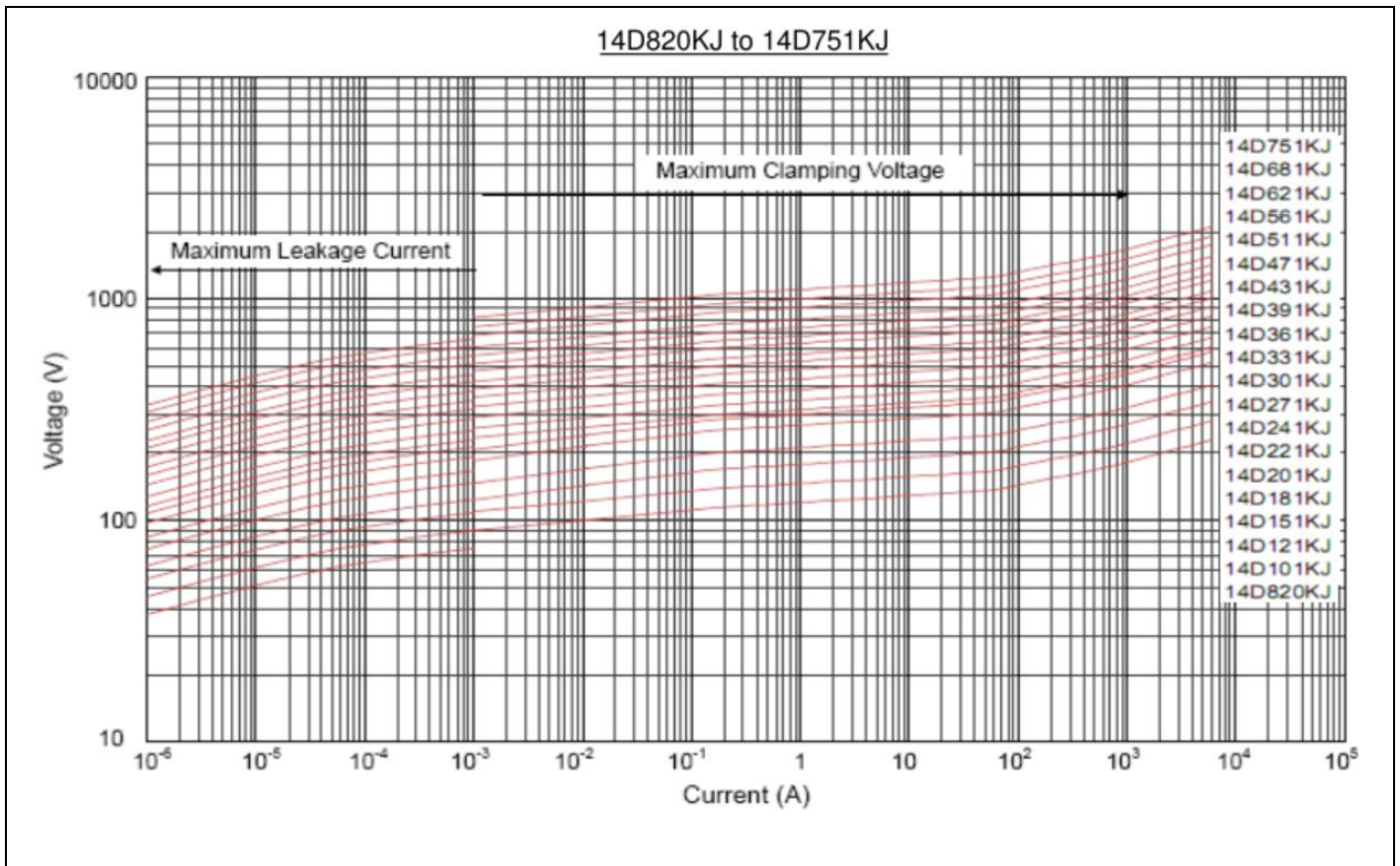

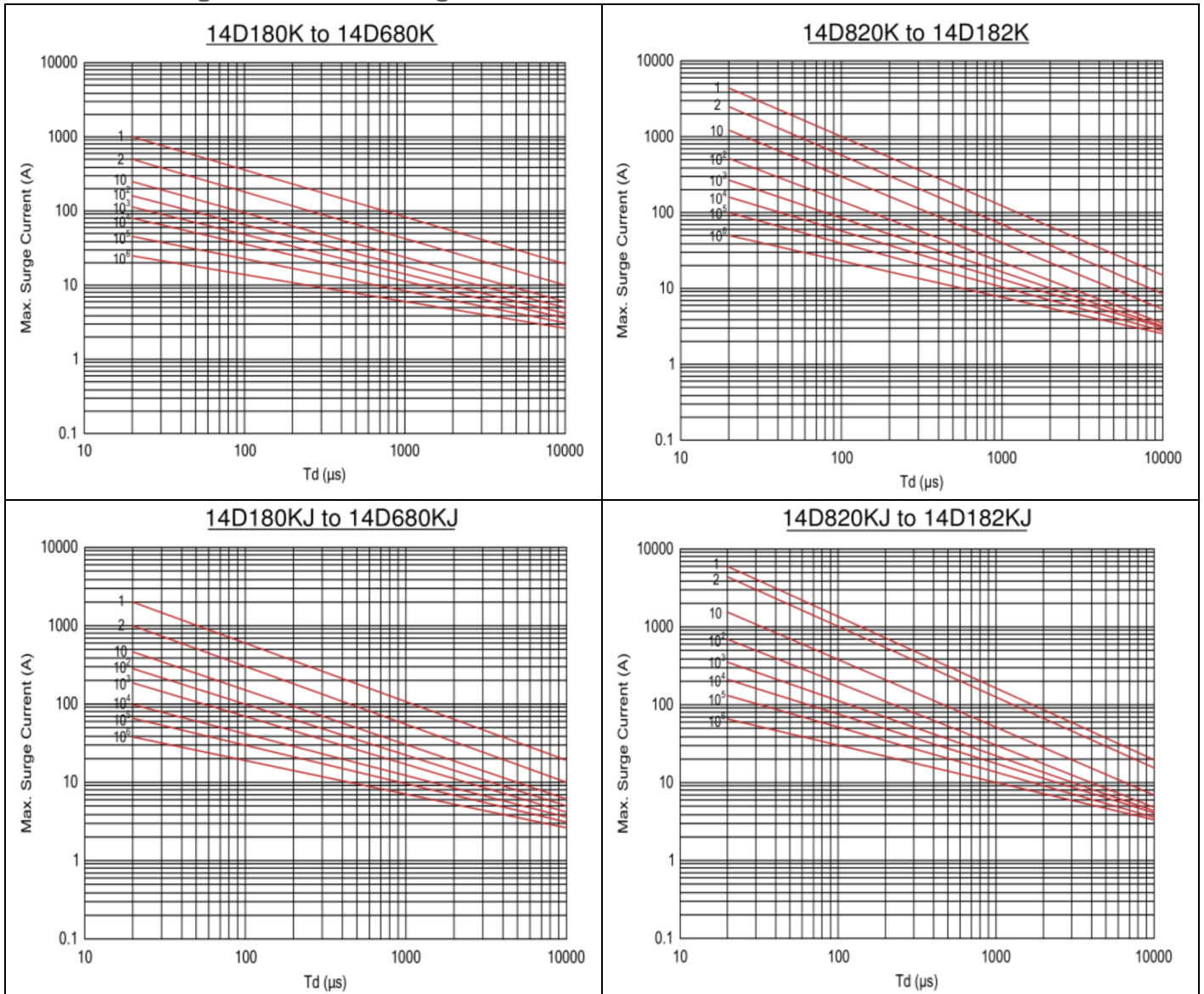

### Maximum Surge Current Derating Curve

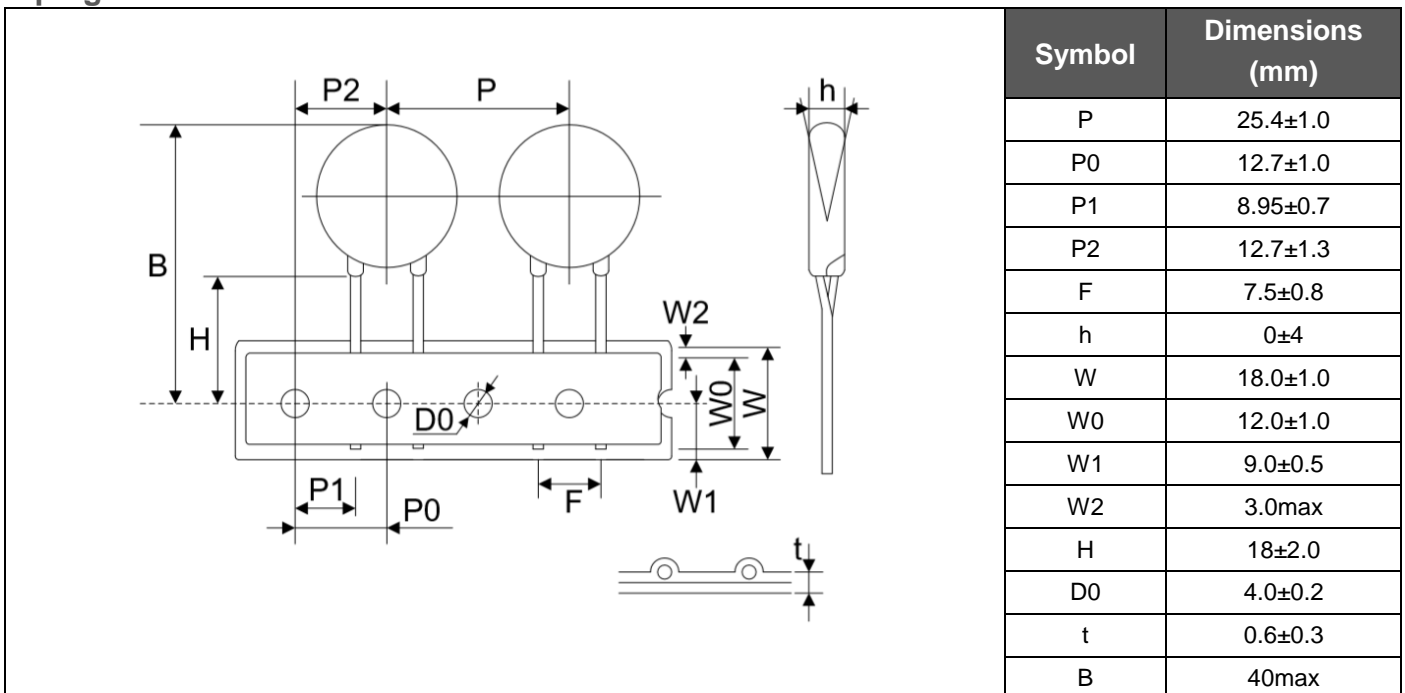

### Taping Dimensions

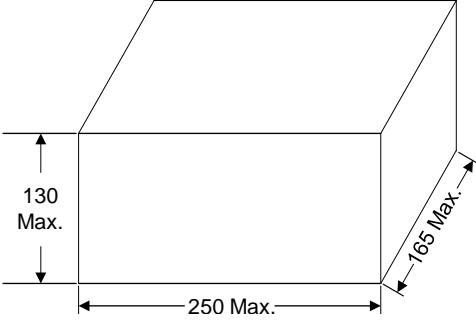

### Quantity

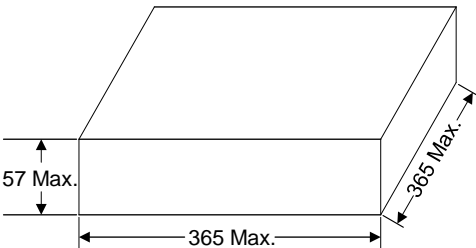
Packaging Dimensions (Unit: mm)	Quantity	
<p>In bulk for Terminals Untrimmed Products</p> 	400pcs/bag (180K~331K)	4bags/box
	300pcs/bag (361K~621K)	
	250pcs/bag (681k~112K)	
	150pcs/bag (122K~182K)	
<p>In bulk for Terminals Trimmed Products</p> 	400pcs/bag (180K~331K)	4bags/box
	300pcs/bag (361K~621K)	
	250pcs/bag (681k~112K)	
	150pcs/bag (122K~182K)	
<p>Tape &amp; Box</p> 	750pcs/bag (180K~331K)	6bags/box
	500pcs/bag (361K~621K)	
	400pcs/bag (681k~751K)	
	350pcs/bag (781K~112K)	
	300pcs/bag (122K~182K)	
<p>Tape &amp; Reel</p> 	750pcs/bag (180K~331K)	6bags/box
	500pcs/bag (361K~621K)	
	400pcs/bag (681k~112K)	
	300pcs/bag (122K~182K)	

## X-ON Electronics

Largest Supplier of Electrical and Electronic Components

*Click to view similar products for [Varistors](#) category:*

*Click to view products by [FTR](#) manufacturer:*

Other Similar products are found below :

[820443211E](#) [MLV0402E30703T](#) [MLV0603E30403T](#) [B72205S271K111](#) [B72207S350K311](#) [B72207S381K101](#) [B72260B102K1](#)  
[B72260B251K1](#) [B72280B0381K001](#) [B72280B0461K001](#) [B72280B271K1](#) [B72650M0151K093](#) [B72660M0271K093](#) [S10K11G5S5](#) [ERZ-](#)  
[C07DK221U](#) [TND10V-471KB00AAA0](#) [B72205S301K211](#) [B72207S141K111](#) [B72210S271K111](#) [B72214S350K551](#) [B72220P3351K101](#)  
[B72280B0231K001](#) [B72280B112K1](#) [B72280B381K1](#) [B72590D360A60](#) [B72650M0400K072](#) [B72650M0500K072](#) [B72660M0200K072](#)  
[B72660M1300K072](#) [B72670M1140K72](#) [MLV0603E30703T](#) [MLV0603E32503T](#) [TVZ18EC271KBS](#) [TVZ20EB911KBS](#) [TVZ25D201KBS](#)  
[TVZ25D241KBS](#) [419-2080-101](#) [ERZ-V20R201](#) [MLV0805E31103T](#) [MLV0805E30703T](#) [ERZ-V20R221](#) [B72205S350K211](#)  
[B72210P2511K101](#) [B72214S271K501](#) [B72220P3551K101](#) [B72240B681K1](#) [B72650M350K72](#) [TVZ20ECN511KBS](#) [TVZ20EC911KBS](#)  
[TVZ20EBN911KBS](#)