

Metal Oxide Varistors (MOV) Data Sheet

Features

- Fast responding to transient over-voltage
- Large absorbing transient energy capability
- Low clamping ratio and no follow-on current
- Meets MSL level 1, per J-STD-020
- Operating Temperature: -40°C ~ +105°C & -40°C ~ +125°C
- Storage Temperature: -40°C ~ +125°C
- Agency recognition: UL 1449 4th /cUL/TUV/CQC

Applications

- Power supply, Telecommunication, Smart meter, or PLC protection
- Surge protection in consumer electronics
- Surge protection in industrial electronics
- Surge protection in electronic home appliances, gas and petroleum appliances
- Relay and electromagnetic valve surge absorption

Part Number Code

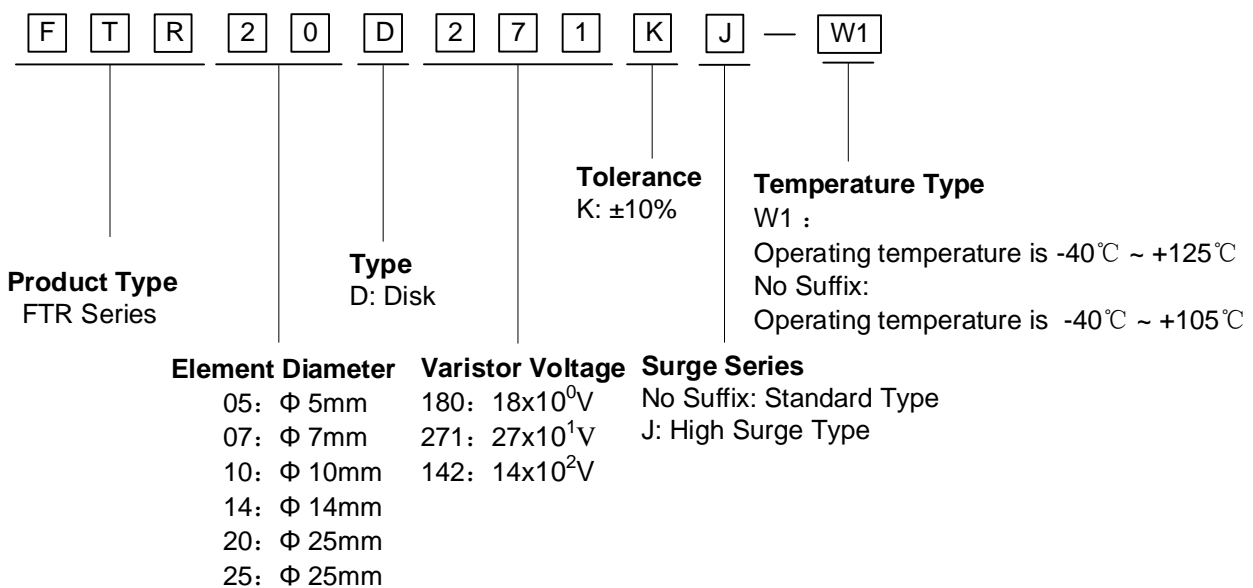

Electrical Characteristics

Part Number		Maximum Allowable Voltage		Varistor Voltage	Maximum Clamping Voltage		Withstanding Surge current		Maximum Energy (10/1000μs)		Rated Power	Dimension T _{max}
Standard	High Surge	V _{AC} (V)	V _{DC} (V)	V _{1mA} (V)	I _P (A)	V _C (V)	(A) Standard	(A) High Surge	(J) Standard	(J) High Surge	(W)	(mm)
FTR20D180K	FTR20D180KJ	11	14	18(15~21.6)	20	36	2000	3000	11	13	0.2	5.0
FTR20D220K	FTR20D220KJ	14	18	22(19.5~26)	20	43	2000	3000	14	16	0.2	5.0
FTR20D270K	FTR20D270KJ	17	22	27(24~31)	20	53	2000	3000	16	19	0.2	5.0
FTR20D330K	FTR20D330KJ	20	26	33(29.5~36.5)	20	65	2000	3000	23	24	0.2	5.0
FTR20D390K	FTR20D390KJ	25	31	39(35~43)	20	77	2000	3000	26	28	0.2	5.0
FTR20D470K	FTR20D470KJ	30	38	47(42~52)	20	93	2000	3000	30	34	0.2	5.0
FTR20D560K	FTR20D560KJ	35	45	56(50~62)	20	110	2000	3000	38	44	0.2	5.0
FTR20D680K	FTR20D680KJ	40	56	68(61~75)	20	135	2000	3000	41	49	0.2	5.0
FTR20D820K	FTR20D820KJ	50	65	82(74~90)	100	135	6500	10000	45	56	1.0	5.0
FTR20D101K	FTR20D101KJ	60	85	100(90~110)	100	165	6500	10000	50	70	1.0	4.6
FTR20D121K	FTR20D121KJ	75	100	120(108~132)	100	200	6500	10000	55	85	1.0	4.8
FTR20D151K	FTR20D151KJ	95	125	150(135~165)	100	250	6500	10000	70	106	1.0	4.4
FTR20D181K	FTR20D181KJ	115	150	180(162~198)	100	300	6500	10000	85	130	1.0	4.5
FTR20D201K	FTR20D201KJ	130	170	200(180~220)	100	340	6500	10000	95	140	1.0	4.6
FTR20D221K	FTR20D221KJ	140	180	220(198~242)	100	360	6500	10000	100	155	1.0	4.7
FTR20D241K	FTR20D241KJ	150	200	240(216~264)	100	395	6500	10000	108	168	1.0	4.8
FTR20D271K	FTR20D271KJ	175	225	270(243~297)	100	455	6500	10000	127	190	1.0	5.0
FTR20D301K	FTR20D301KJ	190	250	300(270~330)	100	500	6500	10000	136	210	1.0	5.0
FTR20D331K	FTR20D331KJ	210	275	330(297~363)	100	550	6500	10000	150	228	1.0	5.1
FTR20D361K	FTR20D361KJ	230	300	360(324~396)	100	595	6500	10000	163	255	1.0	5.3
FTR20D391K	FTR20D391KJ	250	320	390(351~429)	100	650	6500	10000	180	275	1.0	5.4
FTR20D431K	FTR20D431KJ	275	350	430(387~473)	100	710	6500	10000	190	305	1.0	5.6
FTR20D471K	FTR20D471KJ	300	385	470(423~517)	100	775	6500	10000	204	350	1.0	5.8
FTR20D511K	FTR20D511KJ	320	415	510(459~561)	100	845	6500	10000	210	360	1.0	6.0
FTR20D561K	FTR20D561KJ	350	460	560(504~616)	100	925	6500	10000	215	380	1.0	6.4
FTR20D621K	FTR20D621KJ	385	505	620(558~682)	100	1025	6500	10000	224	390	1.0	6.7
FTR20D681K	FTR20D681KJ	420	560	680(612~748)	100	1120	6500	10000	230	400	1.0	7.0
FTR20D751K	FTR20D751KJ	460	615	750(675~825)	100	1240	6500	10000	255	420	1.0	7.1
FTR20D781K	FTR20D781KJ	485	640	780(702~858)	100	1290	6500	10000	265	440	1.0	7.2
FTR20D821K	FTR20D821KJ	510	670	820(738~902)	100	1355	6500	10000	282	460	1.0	7.4
FTR20D911K	FTR20D911KJ	550	745	910(819~1001)	100	1500	6500	10000	310	510	1.0	7.8
FTR20D102K	FTR20D102KJ	625	825	1000(900~1100)	100	1650	6500	10000	342	565	1.0	7.8
FTR20D112K	FTR20D112KJ	680	895	1100(990~1210)	100	1815	6500	10000	383	620	1.0	8.2
FTR20D122K	FTR20D122KJ	750	990	1200(1080~1320)	100	1980	6500	10000	408	660	1.0	8.6
FTR20D142K	FTR20D142KJ	880	1140	1400(1260~1540)	100	2310	6500	10000	532	784	1.0	9.1

Part Number		Maximum Allowable Voltage		Varistor Voltage	Maximum Clamping Voltage		Withstanding Surge current		Maximum Energy (10/1000μs)		Rated Power	Dimension T _{max}
Standard	High Surge	V _{AC} (V)	V _{DC} (V)	V _{1mA} (V)	I _P (A)	V _C (V)	(A) Standard	(A) High Surge	(J) Standard	(J) High Surge	(W)	(mm)
FTR20D162K	FTR20D162KJ	1000	1280	1600(1440~1760)	100	2640	6500	10000	606	896	1.0	10.2
FTR20D182K	FTR20D182KJ	1100	1465	1800(1620~1980)	100	2970	6500	10000	625	990	1.0	10.8

- Notes: 1. The tolerance of varistor voltage between 18V and 27V is more than 10%.
 2. Varistor voltage $\geq 1200V$, structure diagram is F type.
 3. Leakage Current (@83% of V_{1mA}): $IR \leq 50\mu A$ (180K~680K) ; $IR \leq 25\mu A$ (820K~182K)

Dimensions

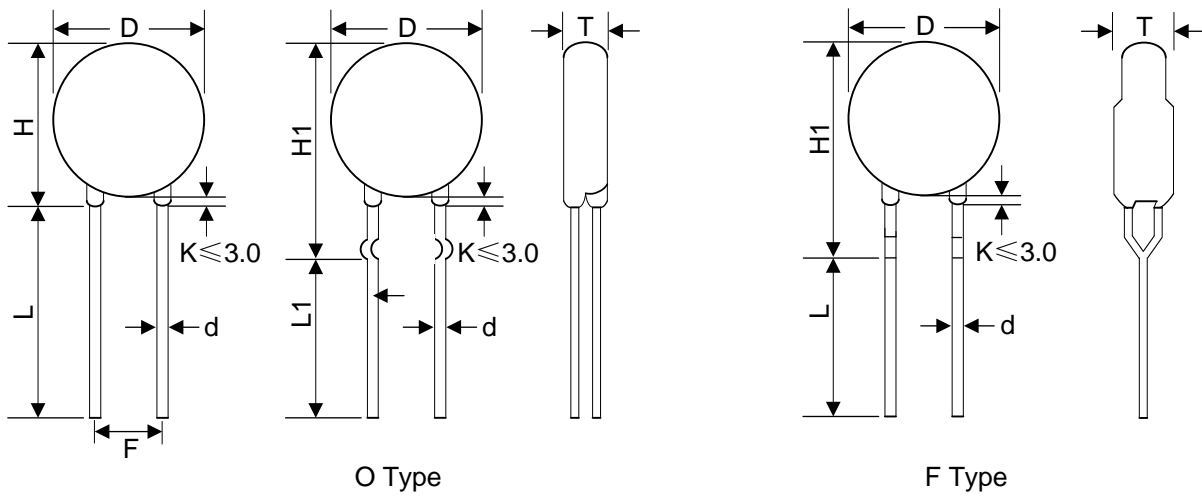

Symbol	H(max.)	H1(Max.)	L(min.)	L1(min.)	D (max.)	F(±0.8)	d(±0.05)	Tmax
Dimension(mm)	25.5	28	20	15	22.5	10	1	Please refer to the Electrical Characteristics Table

Marking Code

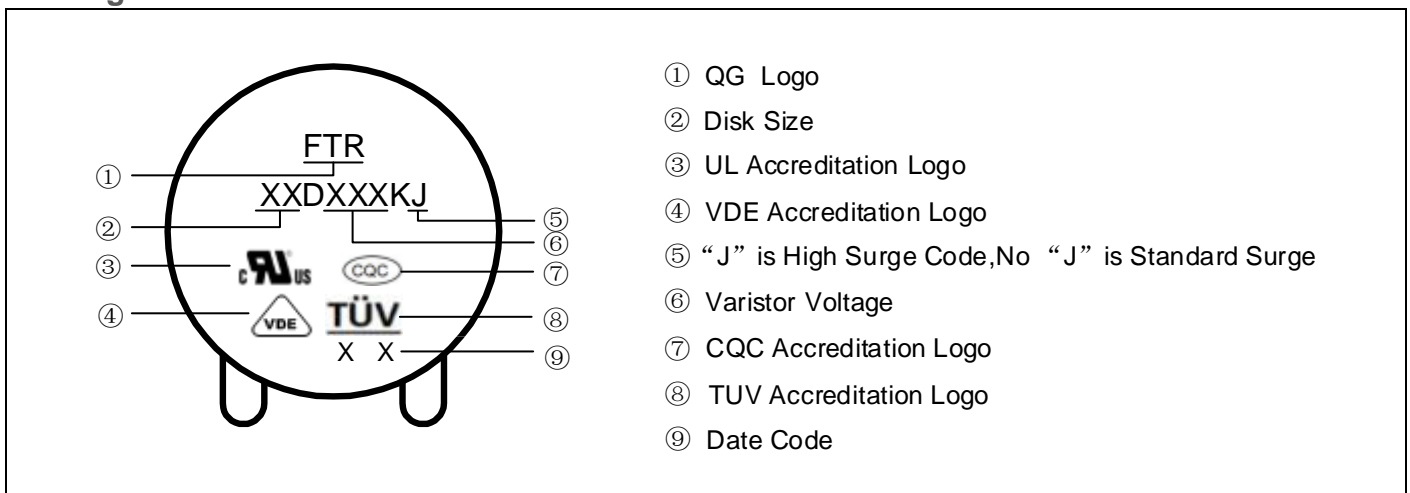

Electrical Ratings

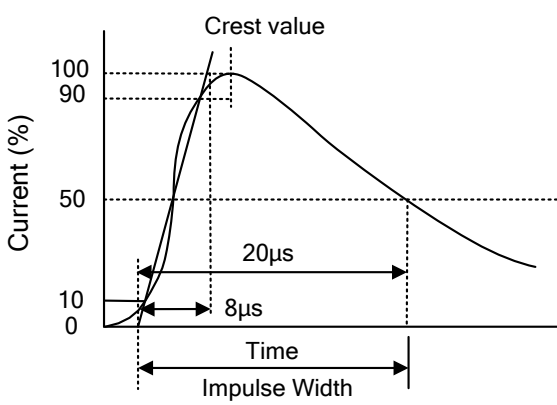
Items	Test Condition/Description	Requirement					
Varistor Voltage	The voltage between two terminals with the specified measuring current 1mA.DC applied is called Vb.	To meet the Specified value					
Maximum Allowable Voltage	The recommended maximum sine wave voltage (RMS) or the Maximum DC voltage can be applied continuously.						
Maximum Clamping Voltage	<p>The maximum voltage between two terminals with the specification standard impulse current. Applied waveform: 8/20μs</p> 						
Rated Wattage	The maximum average power that can be applied within the specified ambient temperature.						
Energy	The maximum energy within the varistor voltage change of ±10% when one impulse of 10/1000μs or 2ms is applied.						
Withstanding Surge Current	The maximum current within the varistor voltage change of ±10% with the standard impulse current (8/20μs) applied one time.						
Varistor Voltage Temp. Coefficient	$\left \frac{V_{1mA@85^{\circ}C} - V_{1mA@25^{\circ}C}}{V_{1mA@25^{\circ}C}} \times \frac{1}{60} \times 100\% (\%/^{\circ}C) \right $ $\left \frac{V_{1mA@-40^{\circ}C} - V_{1mA@25^{\circ}C}}{V_{1mA@25^{\circ}C}} \times \frac{1}{65} \times 100\% (\%/^{\circ}C) \right $		≤0.05%/°C				
Surge Life	<p>The change of Vb shall be measured after the impulse listed below which is applied 10,000 times continuously with the interval of ten seconds at room temperature.</p> <table border="1" data-bbox="438 1892 1204 2016"> <tr> <td rowspan="2">20Φ series</td> <td>180K to 680K</td> <td>100A (8/20μs)</td> </tr> <tr> <td>820K to 182K</td> <td>200A (8/20μs)</td> </tr> </table>	20Φ series	180K to 680K	100A (8/20μs)	820K to 182K	200A (8/20μs)	$\frac{\Delta V_b}{V_b} \leq \pm 10\%$
20Φ series	180K to 680K		100A (8/20μs)				
	820K to 182K	200A (8/20μs)					

Mechanical Characteristics

Items	Test conditions / Methods	Specifications								
Tensile Strength of Terminals	<p>Gradually applying the force specified and keeping the unit fixed for 10±1 sec.</p> <table border="1"> <tr> <td>Terminal diameter (mm)</td> <td>Force(kg)</td> </tr> <tr> <td>0.5<d≤0.8</td> <td>1.0</td> </tr> <tr> <td>0.8<d≤1.25</td> <td>2.0</td> </tr> <tr> <td>1.25<d</td> <td>4.0</td> </tr> </table>	Terminal diameter (mm)	Force(kg)	0.5<d≤0.8	1.0	0.8<d≤1.25	2.0	1.25<d	4.0	<p>NO Visible damage Δ V1mA/V1mA ≤5%</p>
Terminal diameter (mm)	Force(kg)									
0.5<d≤0.8	1.0									
0.8<d≤1.25	2.0									
1.25<d	4.0									
Bending Strength of Terminals	<p>Hold specimen and apply the force specified below to each lead. Bend the specimen to 90°, then return to the original position. Repeat the procedure in the opposite direction.</p> <table border="1"> <tr> <td>Terminal diameter (mm)</td> <td>Force(kg)</td> </tr> <tr> <td>0.5<d≤0.8</td> <td>0.5</td> </tr> <tr> <td>0.8<d≤1.25</td> <td>1.0</td> </tr> <tr> <td>1.25<d</td> <td>2.0</td> </tr> </table>	Terminal diameter (mm)	Force(kg)	0.5<d≤0.8	0.5	0.8<d≤1.25	1.0	1.25<d	2.0	<p>NO Visible damage Δ V1mA/V1mA ≤5%</p>
Terminal diameter (mm)	Force(kg)									
0.5<d≤0.8	0.5									
0.8<d≤1.25	1.0									
1.25<d	2.0									
Vibration	<p>Frequency range: 10~55 Hz Amplitude: 0.75mm or 98m/s² Direction: 3 mutually perpendicular directions, 2hrs each.</p>	<p>NO Visible damage Δ V1mA/V1mA ≤5%</p>								
Solder ability	<p>Solder Temp: 245±5°C Dipping Time: 2±0.5 sec</p>	<p>At least 95% of terminal electrode is covered by new solder</p>								
Resistanceto Soldering Heat	<p>Solder Temp: 260±5°C Dipping Time: 10±1 sec</p>	<p>NO Visible damage Δ V1mA/V1mA ≤5%</p>								

Reliability

Items	Test conditions / Methods	Specifications															
High Temperature Storage	<p>Ambient Temp: 125±2°C Duration: 1000hrs</p>	<p> Δ V1mA/V1mA ≤5%</p>															
Low Temperature Storage	<p>Ambient Temp: -40±2°C Duration: 1000hrs</p>	<p> Δ V1mA/V1mA ≤5%</p>															
Humidity	<p>Ambient Temp: 40±2°C, 90~95% R.H. Duration: 1000hrs</p>	<p> Δ V1mA/V1mA ≤5%</p>															
Temperature Cycle	<p>The conditions shown below shall be repeated 5 cycles</p> <table border="1"> <thead> <tr> <th>Step</th> <th>Temperature (°C)</th> <th>Period (minutes)</th> </tr> </thead> <tbody> <tr> <td>1</td> <td>-40±3</td> <td>30±3</td> </tr> <tr> <td>2</td> <td>Room temperature</td> <td>15±3</td> </tr> <tr> <td>3</td> <td>125±3</td> <td>30±3</td> </tr> <tr> <td>4</td> <td>Room temperature</td> <td>15±3</td> </tr> </tbody> </table>	Step	Temperature (°C)	Period (minutes)	1	-40±3	30±3	2	Room temperature	15±3	3	125±3	30±3	4	Room temperature	15±3	<p>No visible damage ΔV1mA/V1mA ≤5%</p>
Step	Temperature (°C)	Period (minutes)															
1	-40±3	30±3															
2	Room temperature	15±3															
3	125±3	30±3															
4	Room temperature	15±3															
High Temperature Load	<p>Ambient Temp: 105±2°C Duration: 1000hrs Load: Max. Allowable Voltage In AC eara.</p>	<p> ΔV1mA/V1mA ≤5%</p>															
Damp Heat Load	<p>Ambient Temp: 40±2°C, 90~95% R.H. Duration: 1000hrs Load: Max. Allowable Voltage</p>	<p>No visible damage ΔV1mA/V1mA ≤5%</p>															
Voltage Proof	<p>Metal balls method, 2500Vac 1 min.</p>	<p>No visible damage</p>															

Soldering Recommendation

Wave Lead Free Soldering Recommendation



Item	Conditions
Peak Temperature	265°C
Dipping Time	10 seconds(max.)
Soldering	1 time

Recommendation Reworking Conditions with Soldering Iron

Item	Conditions
Temperature of Soldering Iron-tip	360°C(max.)
Soldering Time	3 seconds(max.)
Distance from Varistor	2mm (min.)

Maximum Leakage Current and Maximum Clamping Voltage Curve

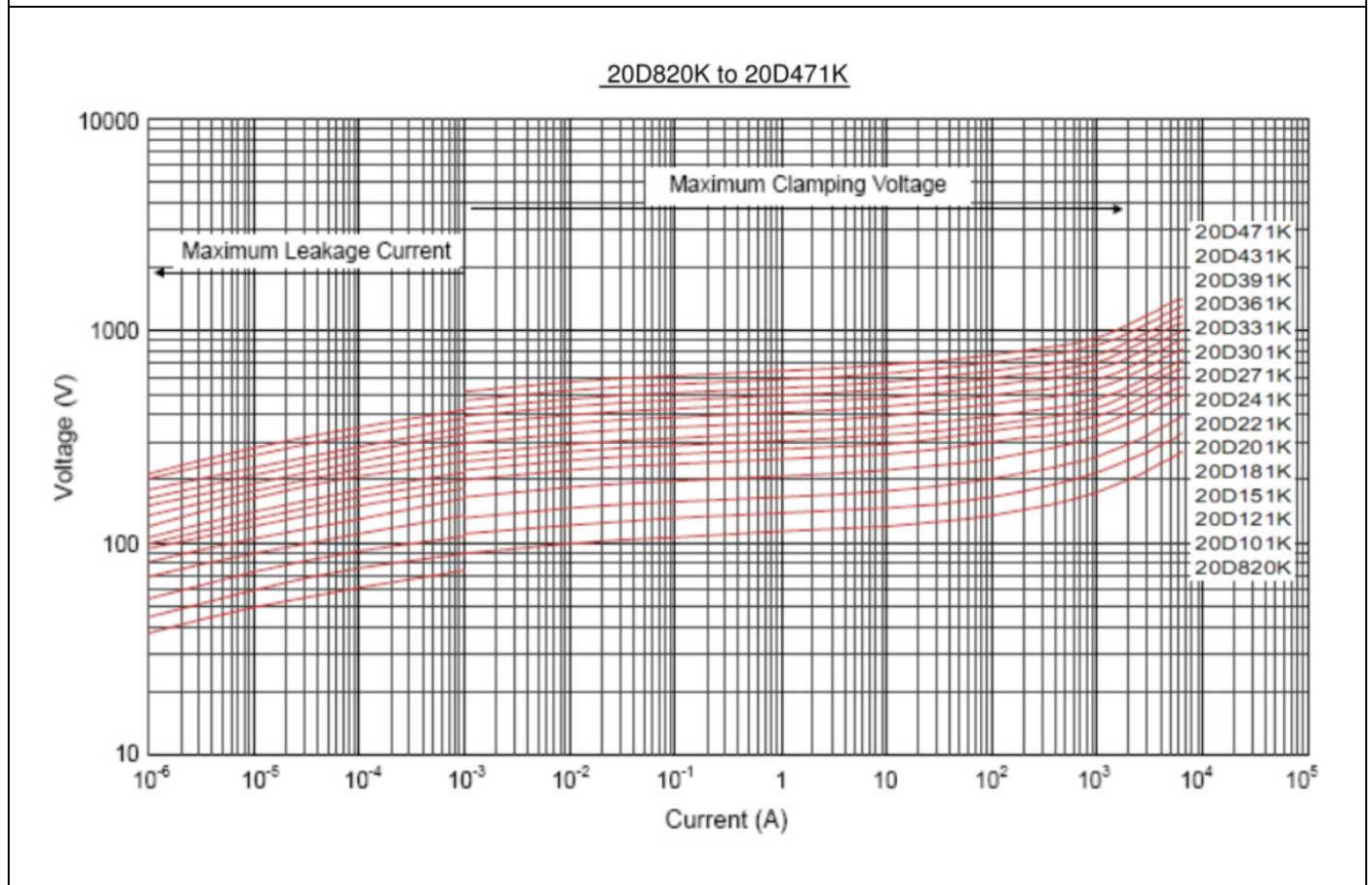
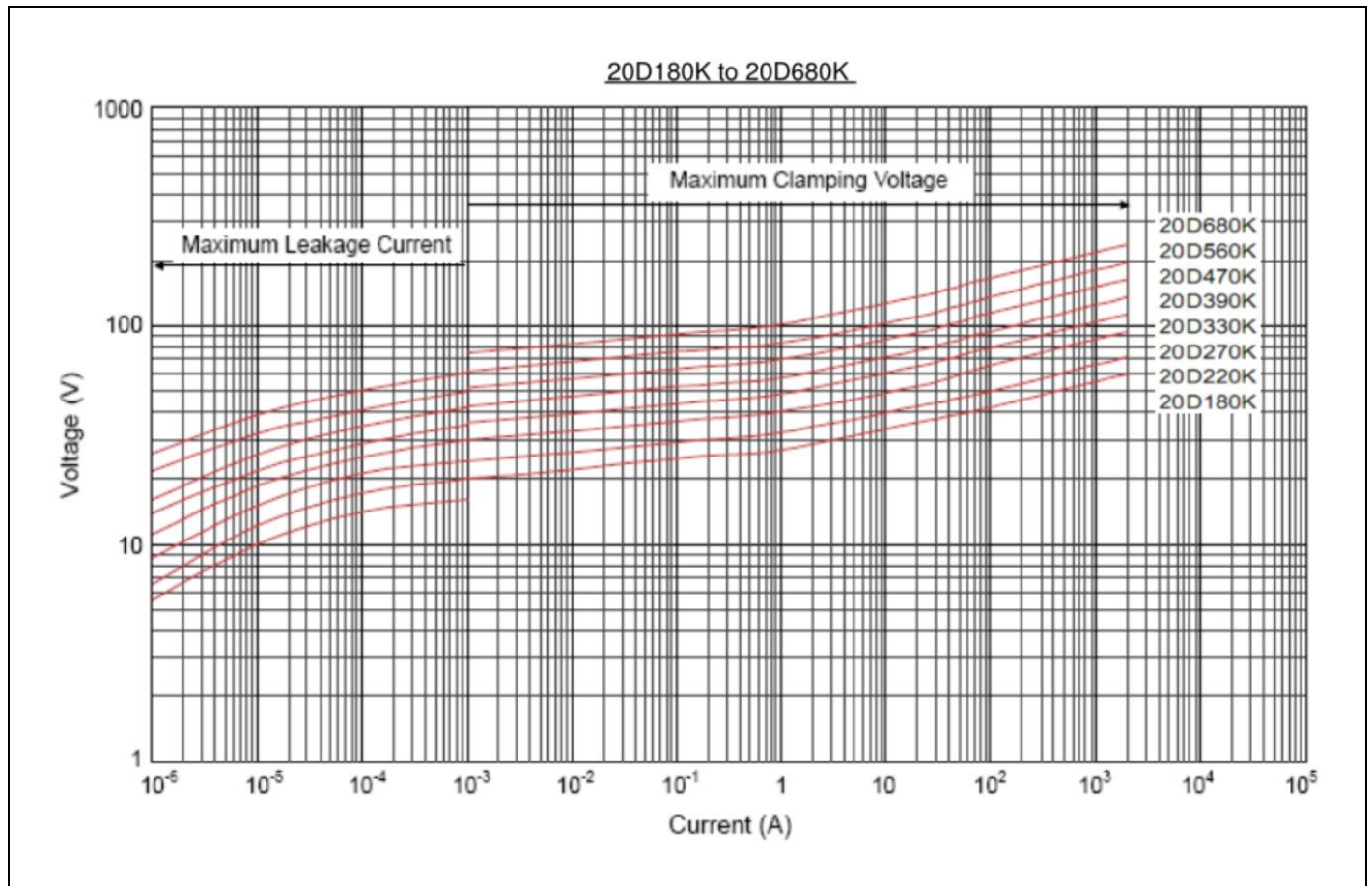

Maximum Leakage Current and Maximum Clamping Voltage Curve

20D511K to 20D182K

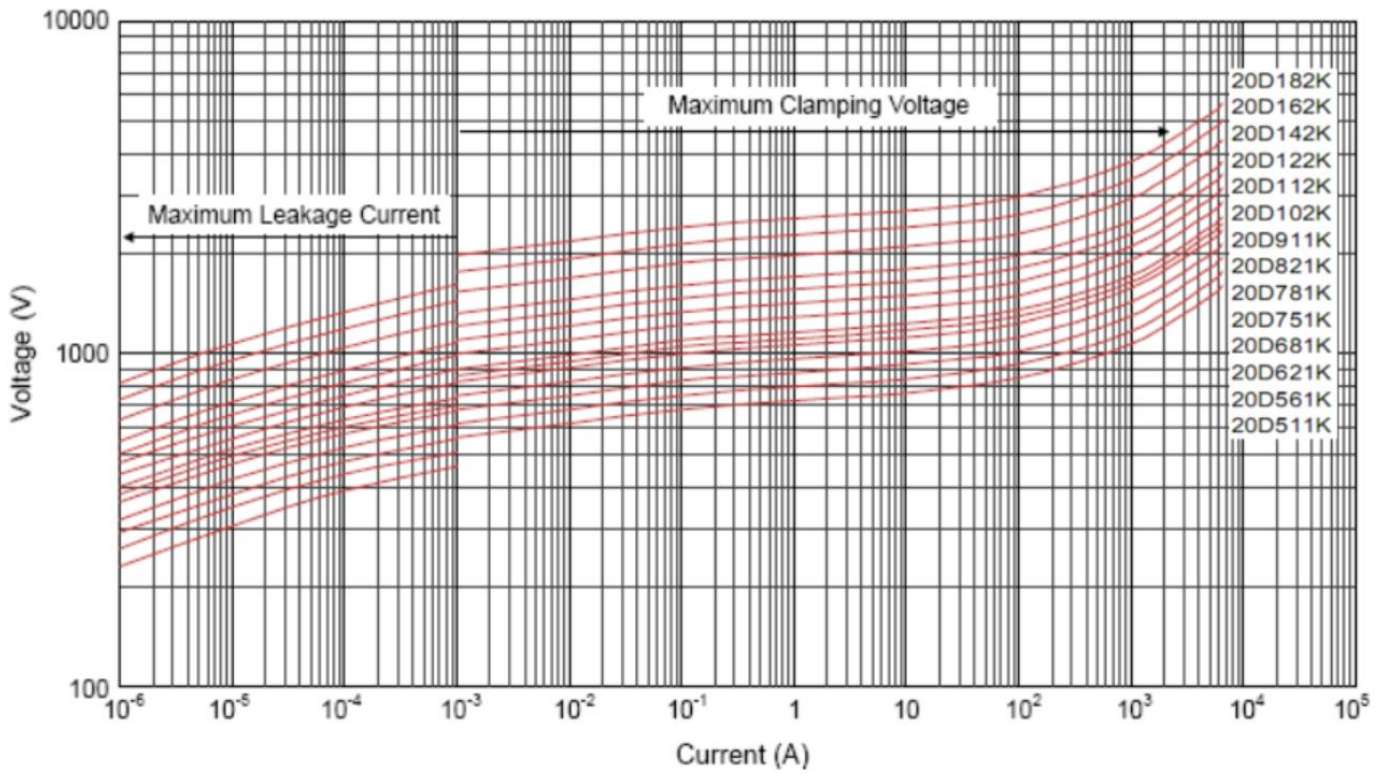

20D180KJ to 20D680KJ

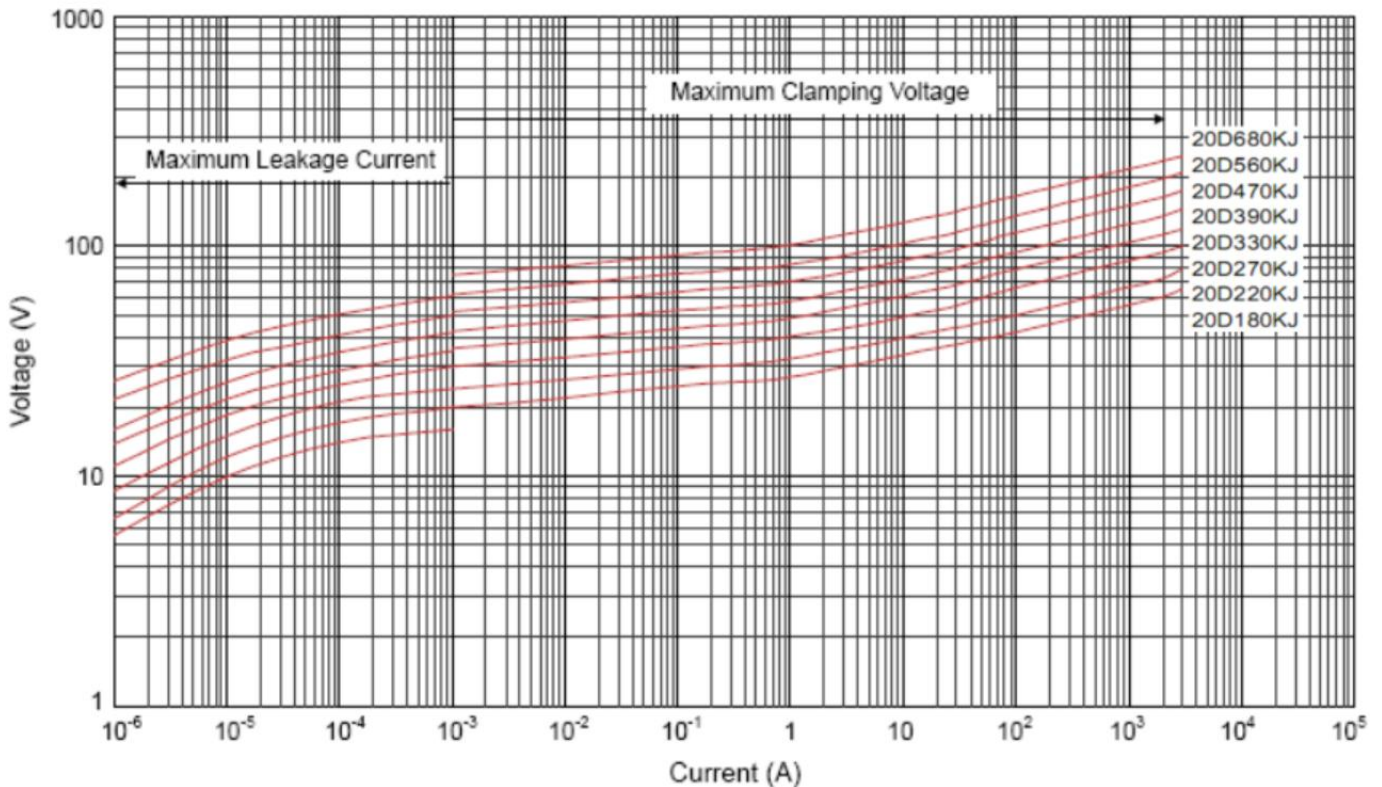

Maximum Leakage Current and Maximum Clamping Voltage Curve

20D820KJ to 20D751KJ

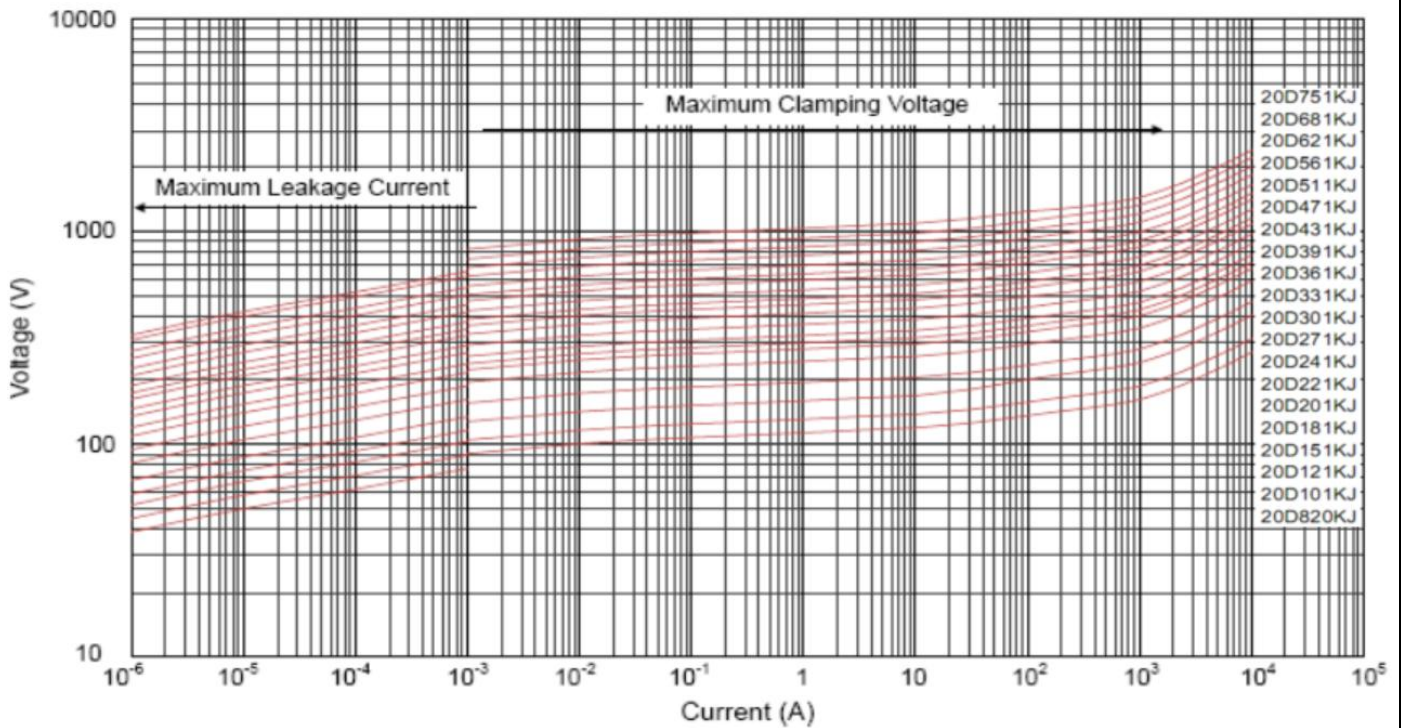

20D781KJ to 20D182KJ

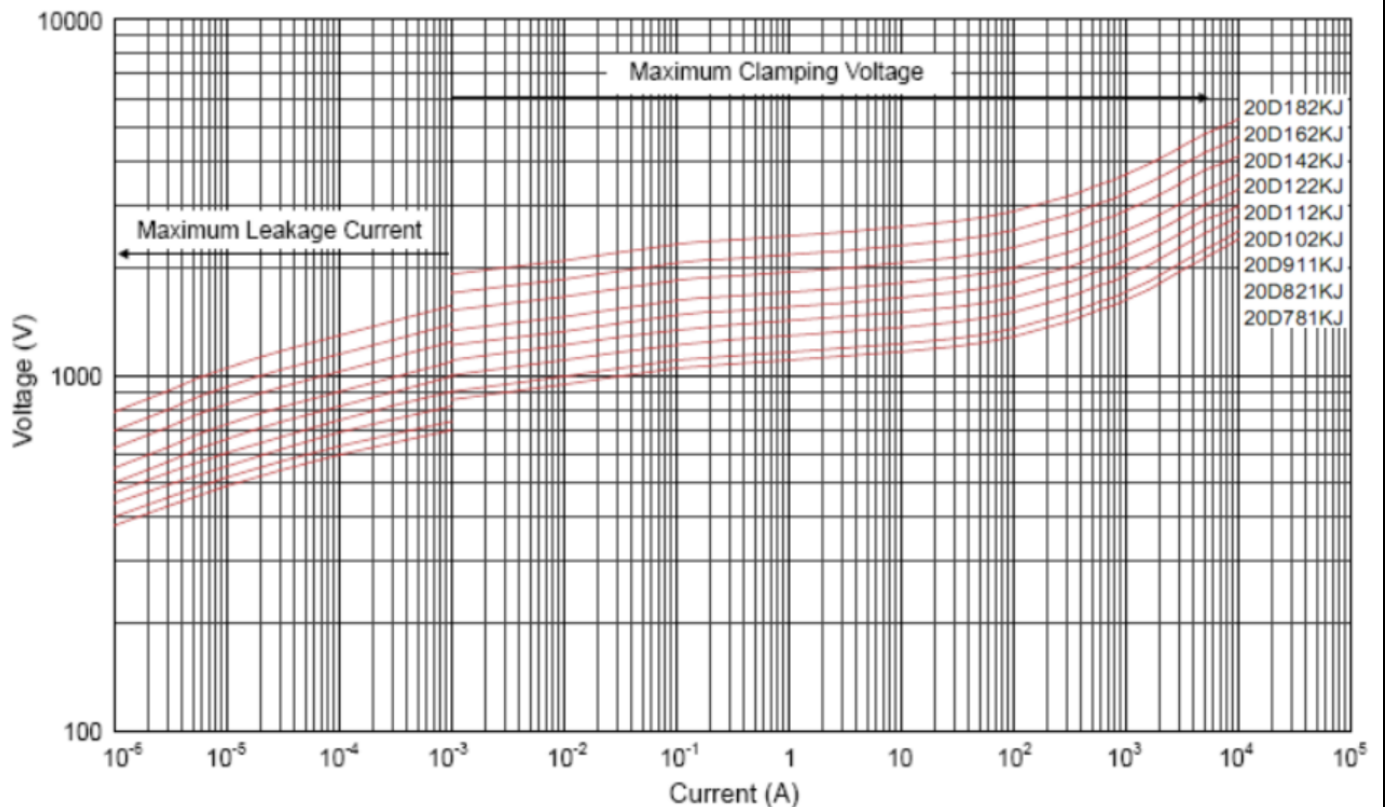

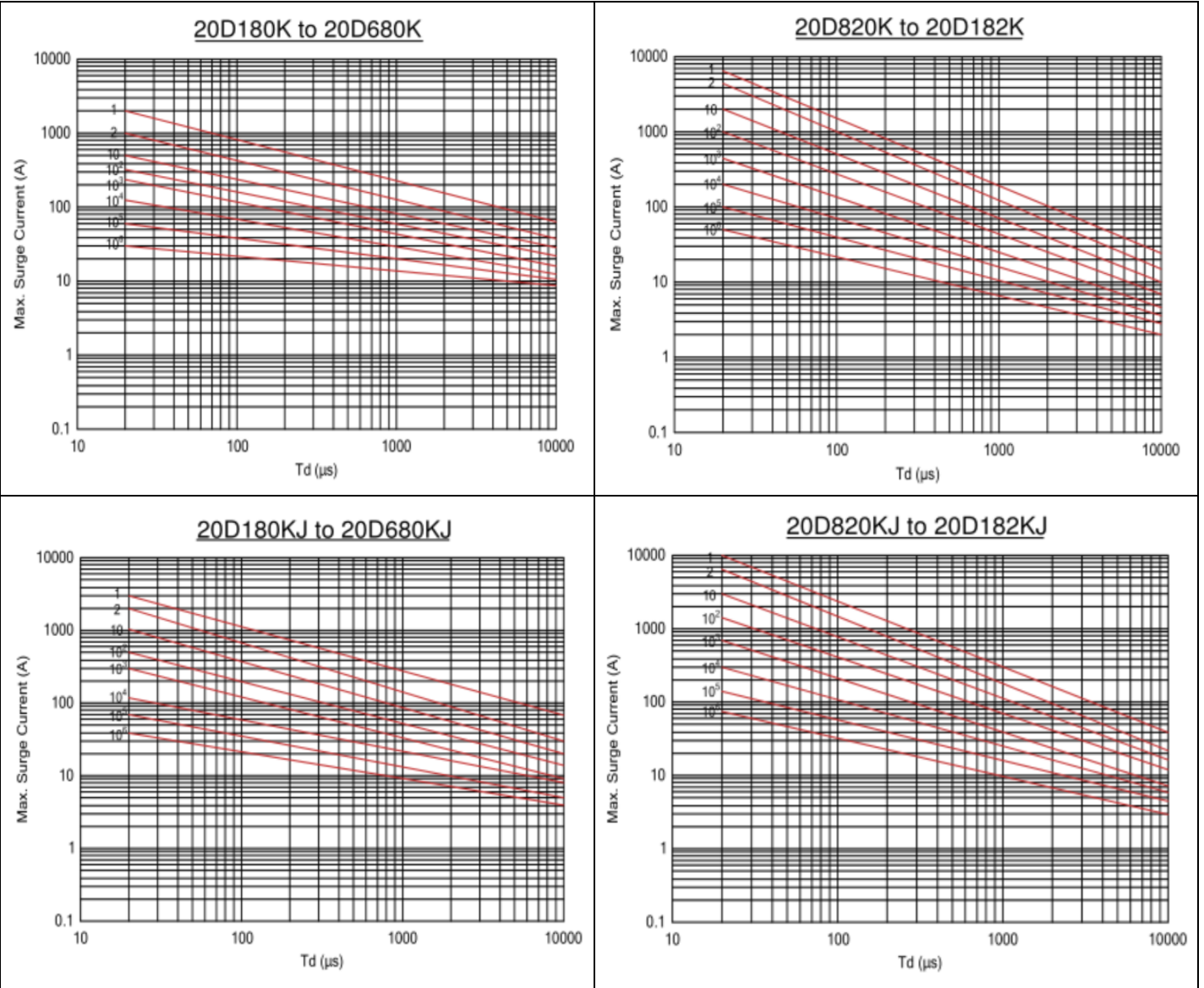

Maximum Surge Current Derating Curve

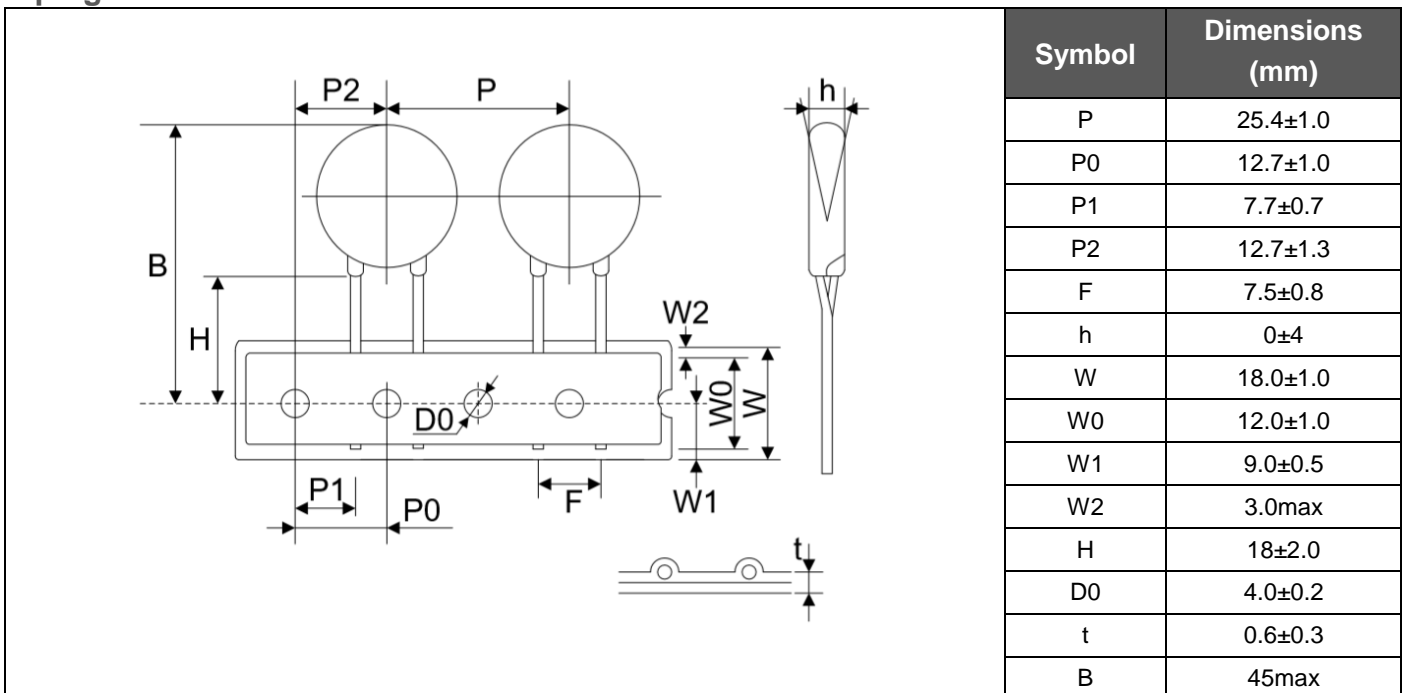

Taping Dimensions

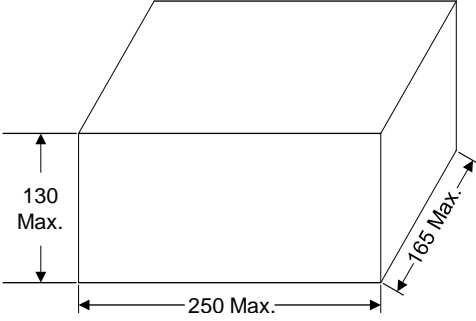

Quantity

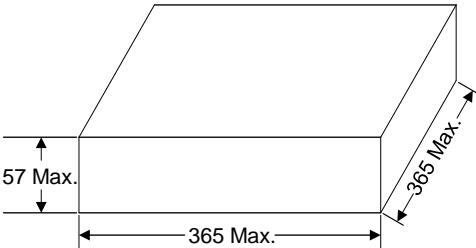
Packaging Dimensions (Unit: mm)	Quantity	
<p>In bulk for Terminals Untrimmed Products</p> 	250pcs/bag (180K~301K)	4bags/box
	200pcs/bag (331K~561K)	
	150pcs/bag (621k~112K)	
	100pcs/bag (122K~182K)	
<p>In bulk for Terminals Trimmed Products</p> 	250pcs/bag (180K~301K)	2bags/box
	200pcs/bag (331K~561K)	
	150pcs/bag (621k~112K)	
	100pcs/bag (122K~182K)	
<p>Tape & Box</p> 	400pcs/bag (180K~301K)	6bags/box
	300pcs/bag (331K~561K)	
<p>Tape & Reel</p> 	400pcs/bag (180K~301K)	6bags/box
	300pcs/bag (331K~561K)	

X-ON Electronics

Largest Supplier of Electrical and Electronic Components

Click to view similar products for [Varistors category](#):

Click to view products by [FTR manufacturer](#):

Other Similar products are found below :

[R71ZOV151HC](#) [B72205S271K111](#) [B72214S251K151](#) [NTE1V020](#) [NTE1V130](#) [25FN511K](#) [S10K11G5S5](#) [ERZ-C14DK361U](#) [ERZ-C20DK221U](#) [207869-1](#) [AS-13](#) [B72540E 350K 62](#) [B72590D360A60](#) [B72650M301K93](#) [B72670M1140K72](#) [TVZ18EC271KBS](#) [TVZ20EB911KBS](#) [TVZ25D201KBS](#) [TVZ25D241KBS](#) [VDRH20X230BSE](#) [VZ07D220KBS](#) [VZ40D241KQ-N](#) [VZ40D241K](#) [VZ25D511KBS-N](#) [VZ20E511KBSX](#) [VZ20E221KBSX](#) [VZ10D471KBS-N](#) [20A9FN241K](#) [B72650M350K72](#) [TVZ25D301KBS](#) [TVZ20EC911KBS](#) [TVZ20EBN911KBS](#) [TVZ18EC471KBS](#) [B72220S350K101](#) [NTE1V030](#) [NTE1V275](#) [NTE2V015](#) [NTE2V035](#) [NTE2V115](#) [VZ20D391KBS-N](#) [VZ10D241KBS-N](#) [VZ07D390KBS-N](#) [VDRH14V060TSE](#) [VDRH20X300BKE](#) [V300LT4PX1841](#) [NTE1V017](#) [NTE1V115](#) [NTE1V150](#) [NTE1V300](#) [NTE2V025](#)