



SPECIFICATION OF PRODUCT

承认书

CUSTOMER: _____

DESCRIPTION: Piezo Buzzer

FUSHENG P/N: FSD-2312W

CUSTOMER P/N: _____

DATE: _____

CUSTOMER	APPROVER	CHECKER
	Yunqing Wu	Bing Yan

泰州福声电子科技有限公司

地址:江苏省泰州市海陵区凤凰西路98号

电话: 0086-523-86219066 传真: 0086-523-81601108

邮箱: sales@electronic-tech.cn

网址: www.tzfsdz.com

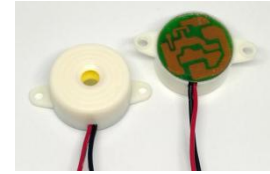

1. SPECIFICATION 规格

No.	Item	Unit	Specification	Condition
1	Oscillation Frequency	Hz	4000	
2	Operating Voltage	VDC	3 ~ 24	
3	Rated Voltage	VDC	12	
4	Current Consumption	mA	MAX. 10	at Rated Voltage
5	Sound Pressure Level	dB	MIN. 85	at 10cm at Rated Voltage
6	Operating Temperature	°C	-20 ~ +70	
7	Storage Temperature	°C	-30 ~ +85	
8	Dimension	mm	Φ23.0 x H12	See appearance drawing
9	Weight (MAX)	gram	4	
10	Housing Material		ABS(Black)	
11	Leading Pin		Wire Type	See appearance drawing
12	Environmental Protection Regulation		RoHS	

2. APPEARANCE DRAWING 尺寸图

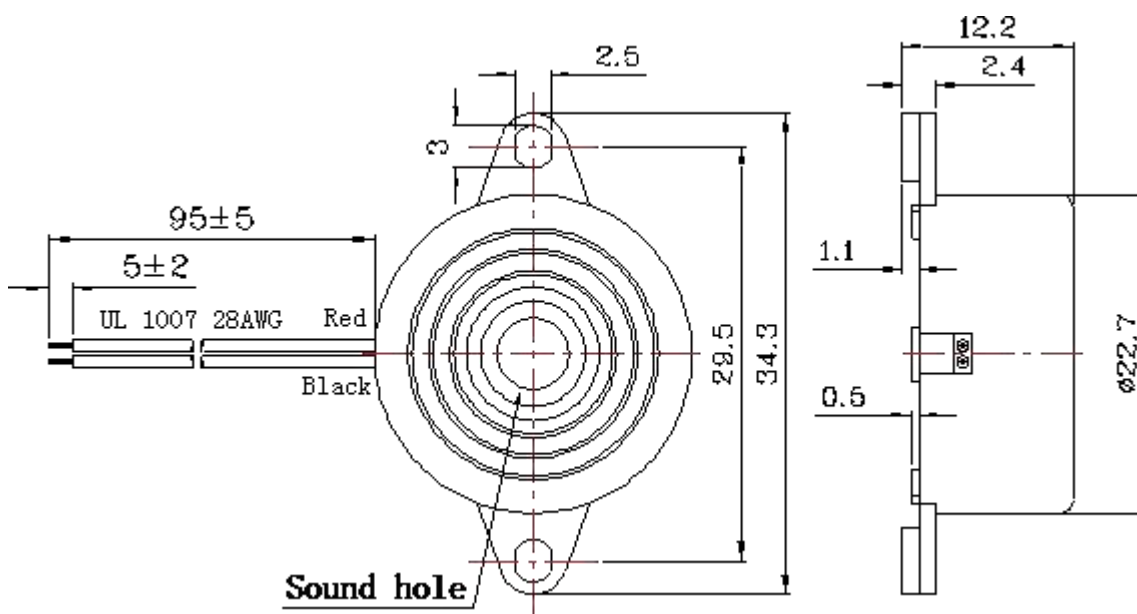

3. TESTING METHOD 测量方式

Standard Measurement conditions

Temperature: $25 \pm 2^\circ\text{C}$ Humidity: 45-65%

Acoustic Characteristics:

The oscillation frequency, current consumption and sound pressure are measured by the measuring instruments shown below

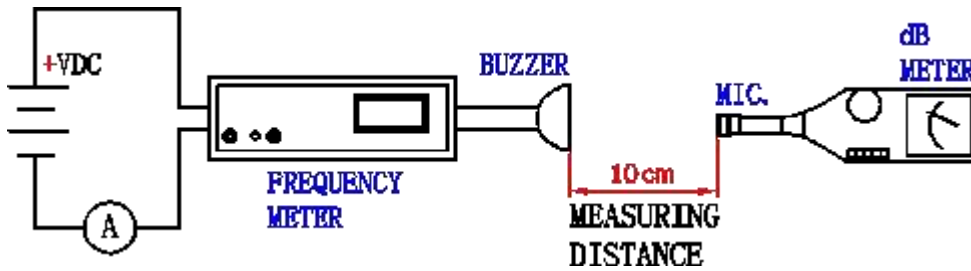

In the measuring test, buzzer is placed as follows:

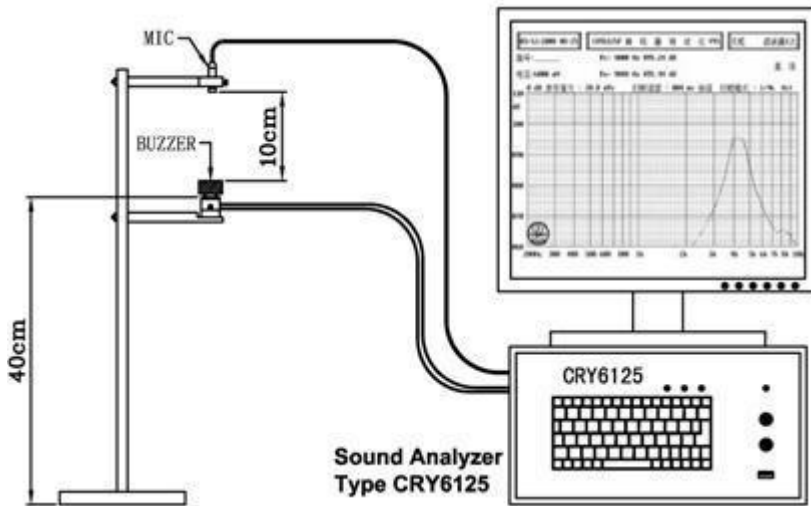

4. VOLTAGE / CURRENT / SOUND PRESSURE CHARACTERISTICS

dB-V

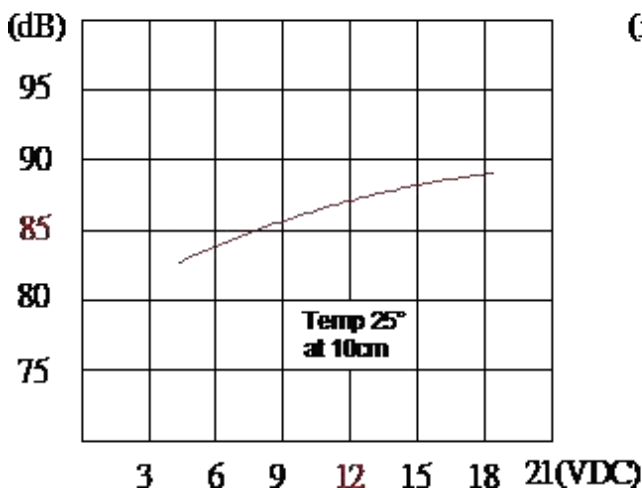

mA-V

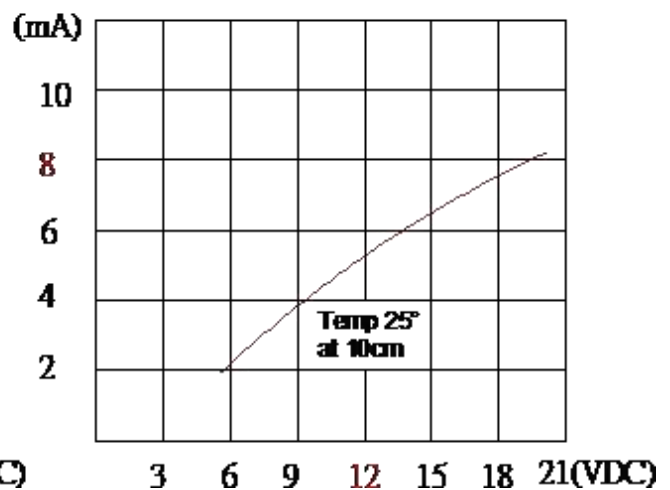

5. RELIABILITY TEST 可靠性测试

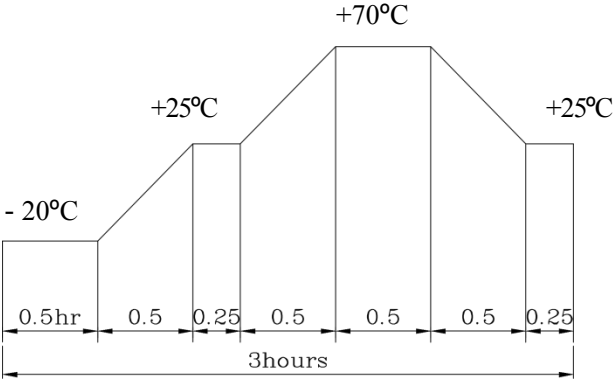
NO.	ITEM	TEST CONDITION AND REQUIREMENT
1	High Temperature Test (Storage)	After being placed in a chamber with 80 °C for 96 hours and then being placed in normal condition for 2 hours. Allowable variation of SPL after test: 10dB.
2	Low Temperature Test (Storage)	After being Placed in a chamber with -30 °C for 96 hours and then being placed in normal condition for 2 hours. Allowable variation of SPL after test: 10dB.
3	Humidity Test	After being Placed in a chamber with 90-95% R.H. at 40 °C for 96 hours and then being placed in normal condition for 2 hours. Allowable variation of SPL after test: 10dB.
4	Temperature Cycle Test	<p>The part shall be subjected to 5 cycles. One cycle shall be consist of:</p>  <p style="text-align: center;"> - 20°C +25°C +70°C +25°C </p> <p style="text-align: center;"> 0.5hr 0.5 0.25 0.5 0.5 0.5 0.25 </p> <p style="text-align: center;">3hours</p> <p>Allowable variation of SPL after test: 10dB.</p>
5	Drop Test	Drop on a hard wood board of 4cm thick, any directions, 6 times, at the height of 75cm. Allowable variation of SPL after test: 10dB.
6	Vibration Test	After being applied vibration of amplitude of 1.5mm with 10 to 55 Hz band of vibration frequency to each of 3 perpendicular directions for 2 hours . Allowable variation of SPL after test: 10dB.
7	Solderability Test	Lead terminals are immersed in rosin for 5 seconds and then immersed in solder bath of +300 °C for 3 1 seconds . 90% min. lead terminals shall be wet with solder (Except the edge of terminals).
8	Terminal Strength Pulling Test	The force of 9.8N(1.0kg) is applied to each terminal in axial direction for 10 seconds. No visible damage and cutting off.

TEST CONDITION.

Standard Test Condition	:	a) Temperature: +5~ +35°C	b) Humidity: 45-85%	c) Pressure: 860-1060mbar
一般测试条件	:	a) 温度 : +5 ~ +35°C	b) 湿度 : 45-85%	c) 气压 : 860-1060mbar
Judgment Test Condition	:	a) Temperature: +25 ± 2°C	b) Humidity: 60-70%	c) Pressure: 860-1060mbar
争议时测试条件	:	a) 温度 : +25 ± 2°C	b) 湿度 : 60-70%	c) 气压 : 860-1060mbar

X-ON Electronics

Largest Supplier of Electrical and Electronic Components

Click to view similar products for [Piezo Buzzers & Audio Indicators](#) category:

Click to view products by [FUET](#) manufacturer:

Other Similar products are found below :

[6-4](#) [68S1240-PA](#) [ESZ-26B](#) [FDG06PSLLF](#) [F/DGX12P WITH LABEL LF](#) [F/EM12PLF](#) [PF-35N29WQ](#) [PFD-21A29W](#) [PFD-27A35PQ](#) [PL-21N30WQ](#) [PL-27A35PSQ](#) [PLD-21N30W](#) [PLD-21N30WQ](#) [PS-531Q](#) [PT-3534FP](#) [B822B](#) [B/CP28/100DB/BLACK LF](#) [S6109](#) [SC110E](#) [SC2036ACP](#) [SC616N-2](#) [SC628FW](#) [SC628MPG](#) [SC648D](#) [SCS045MD9DT3S](#) [ESZ-25B-5-250B](#) [ESZ-25S](#) [F/BC 35-DR LF](#) [FCM12PLF](#) [SSX-52SA](#) [F/EB20P-DR LF](#) [AI-4228-TF-LW305-R](#) [FSMD8585JSLF](#) [F/SU 21-02 LF](#) [F/TCW 05 WITH LABEL LF](#) [PFD-27N36W](#) [PKM35-4A0](#) [PL-35N29WQ](#) [PLD-27A35PQ](#) [PS-552Q](#) [CM-5](#) [REF-202](#) [B/SE 128 RED LF](#) [KBS-20DA-7AS](#) [KBS-27DA-5C-105](#) [LSC628ANR](#) [03-810.001](#) [RTO-1R07-001](#) [PL-21N31PQ](#) [F-B-P1405ISB LF](#)