

6MBP50RA120

IGBT-IPM R series

1200V / 50A 6 in one-package

■ Features

- Temperature protection provided by directly detecting the junction temperature of the IGBTs
- Low power loss and soft switching
- Compatible with existing IPM-N series packages
- High performance and high reliability IGBT with overheating protection
- Higher reliability because of a big decrease in number of parts in built-in control circuit

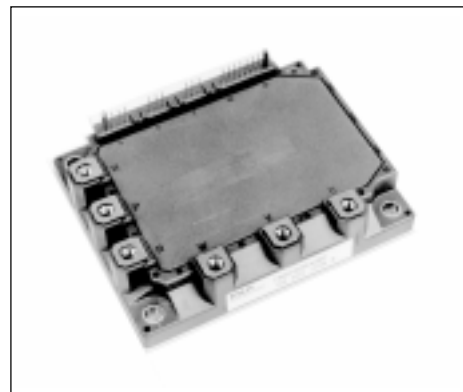

■ Maximum ratings and characteristics

- Absolute maximum ratings (at $T_c=25^\circ\text{C}$ unless otherwise specified)

Item	Symbol	Rating		Unit		
		Min.	Max.			
DC bus voltage	V_{bc}	0	900	V		
DC bus voltage (surge)	$V_{bc}(\text{surge})$	0	1000	V		
DC bus voltage (short operating)	V_{sc}	200	800	V		
Collector-Emitter voltage	V_{CES}	0	1200	V		
INV	Collector current	DC	I_c	-	50	A
		1ms	I_{cP}	-	100	A
		DC	$-I_c$	-	50	A
	Collector power dissipation	One transistor	P_c	-	357	W
Junction temperature	T_j	-	150	$^\circ\text{C}$		
Input voltage of power supply for Pre-Driver	V_{cc}^*1	0	20	V		
Input signal voltage	V_{in}^*2	0	V_z	V		
Input signal current	I_{in}	-	1	mA		
Alarm signal voltage	V_{ALM}^*3	0	V_{cc}	V		
Alarm signal current	I_{ALM}^*4	-	15	mA		
Storage temperature	T_{stg}	-40	125	$^\circ\text{C}$		
Operating case temperature	T_{op}	-20	100	$^\circ\text{C}$		
Isolating voltage (Case-Terminal)	V_{iso}^*5	-	AC2.5	kV		
Screw torque	Mounting (M5)	-	3.5 *6	N·m		
	Terminal (M5)	-	3.5 *6	N·m		

*1 Apply V_{cc} between terminal No. 3 and 1, 6 and 4, 9 and 7, 11 and 10.

*2 Apply V_{in} between terminal No. 2 and 1, 5 and 4, 8 and 7, 13,14,15 and 10.

*3 Apply V_{ALM} between terminal No. 16 and 10.

*4 Apply I_{ALM} to terminal No. 16.

*5 50Hz/60Hz sine wave 1 minute.

*6 Recommendable Value : 2.5 to 3.0 N·m

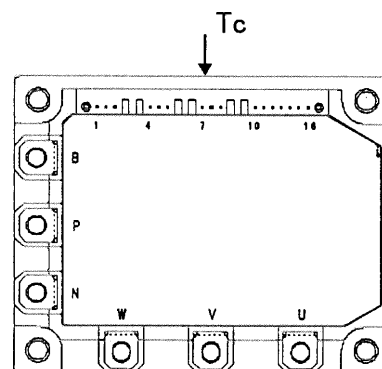

Fig.1 Measurement of case temperature

- Electrical characteristics of power circuit (at $T_c=T_j=25^\circ\text{C}$, $V_{cc}=15\text{V}$)

Item	Symbol	Condition	Min.	Typ.	Max.	Unit	
INV	Collector current at off signal input	I_{CES}	$V_{CE}=1200\text{V}$ input terminal open	-	-	1.0	mA
	Collector-Emitter saturation voltage	$V_{CE(\text{sat})}$	$I_c=50\text{A}$	-	-	2.6	V
	Forward voltage of FWD	V_F	$-I_c=50\text{A}$	-	-	3.0	V

● Electrical characteristics of control circuit(at $T_c=T_j=25^\circ\text{C}$, $V_{cc}=15\text{V}$)

Item	Symbol	Condition	Min.	Typ.	Max.	Unit
Power supply current of P-line side Pre-driver(one unit)	I_{ccp}	fsw=0 to 15kHz $T_c=-20$ to 100°C *7	3	-	18	mA
Power supply current of N-line side three Pre-driver	I_{ccn}	fsw=0 to 15kHz $T_c=-20$ to 100°C *7	10	-	65	mA
Input signal threshold voltage (on/off)	$V_{in(th)}$	ON	1.00	1.35	1.70	V
		OFF	1.25	1.60	1.95	V
Input zener voltage	V_z	$R_{in}=20\text{k ohm}$	-	8.0	-	V
Over heating protection temperature level	T_{COH}	$V_{DC}=0\text{V}$, $I_c=0\text{A}$, Case temperature	110	-	125	$^\circ\text{C}$
Hysteresis	T_{CH}		-	20	-	$^\circ\text{C}$
IGBT chips over heating protection temperature level	T_{JOH}	surface of IGBT chips	150	-	-	$^\circ\text{C}$
Hysteresis	T_{JH}		-	20	-	$^\circ\text{C}$
Collector current protection level	INV I_{OC}	$T_j=125^\circ\text{C}$	75	-	-	A
Over current protection delay time	t_{DOC}	$T_j=25^\circ\text{C}$ Fig.2	-	10	-	μs
Under voltage protection level	V_{UV}		11.0	-	12.5	V
Hysteresis	V_H		0.2	-	-	V
Alarm signal hold time	t_{ALM}		1.5	2	-	ms
SC protection delay time	t_{SC}	$T_j=25^\circ\text{C}$ Fig.3	-	-	12	μs
Limiting resistor for alarm	R_{ALM}		1425	1500	1575	ohm

*7 Switching frequency of IPM

● Dynamic characteristics(at $T_c=T_j=125^\circ\text{C}$, $V_{cc}=15\text{V}$)

Item	Symbol	Condition	Min.	Typ.	Max.	Unit
Switching time (IGBT)	t_{on}	$I_C=50\text{A}$, $V_{DC}=600\text{V}$	0.3	-	-	μs
	t_{off}		-	-	3.6	μs
Switching time (FWD)	t_{rr}	$I_F=50\text{A}$, $V_{DC}=600\text{V}$	-	-	0.4	μs

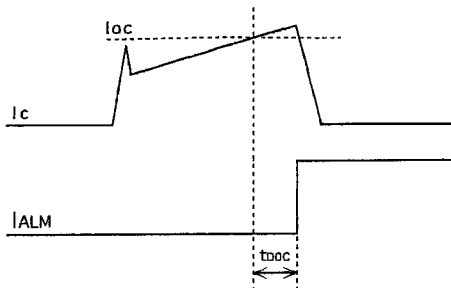

Fig.2 Definition of OC delay time

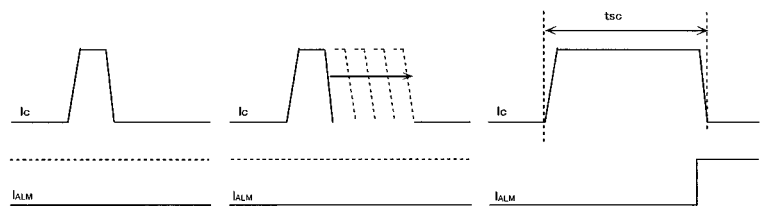

Fig.3 Definition of tsc

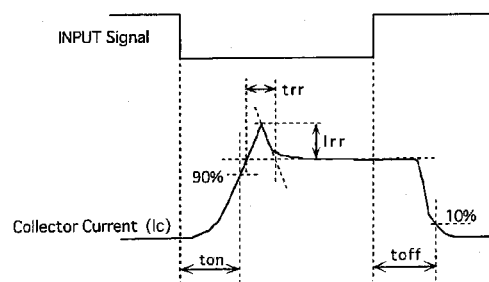

Fig.4 Definition of switching time

● Thermal characteristics($T_c=25^\circ\text{C}$)

Item	Symbol	Typ.	Max.	Unit
Junction to Case thermal resistance	INV IGBT	-	0.35	$^\circ\text{C/W}$
	FWD	-	0.85	$^\circ\text{C/W}$
Case to fin thermal resistance with compound	$R_{th(c-f)}$	0.05	-	$^\circ\text{C/W}$

● Recommendable value

Item	Symbol	Min.	Typ.	Max.	Unit
DC bus voltage	V_{DC}	200	-	800	V
Operating power supply voltage range of Pre-driver	V_{cc}	13.5	15	16.5	V
Switching frequency of IPM	fsw	1	-	20	kHz
Screw torque	Mounting (M5)	-	2.5	3.0	N·m
	Terminal (M5)	-	2.5	3.0	N·m

Block diagram

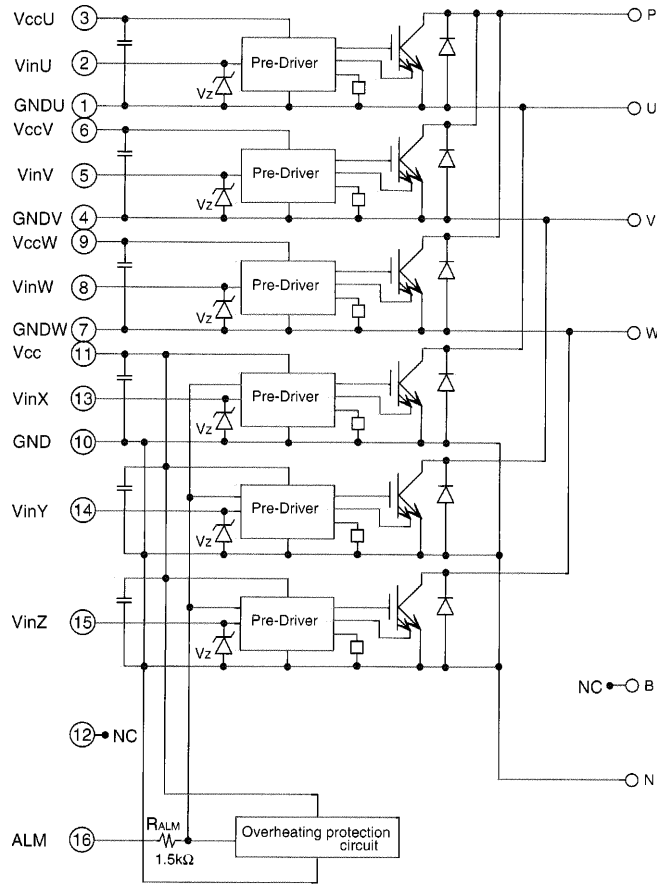

Pre-drivers include following functions

- a) Amplifier for driver
- b) Short circuit protection
- c) Undervoltage lockout circuit
- d) Over current protection
- e) IGBT chip over heating protection

Outline drawings, mm

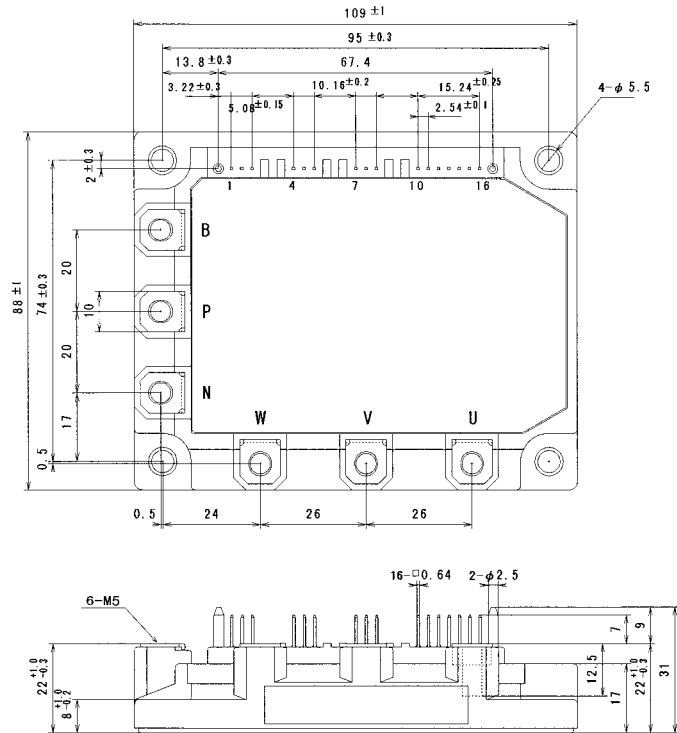

Characteristics (Representative)

Control Circuit

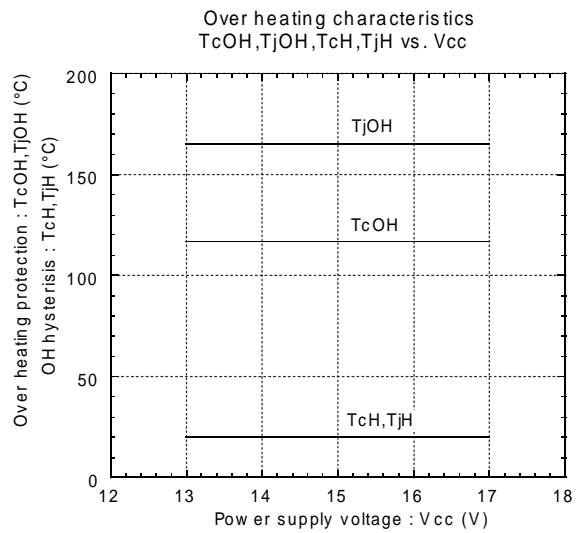
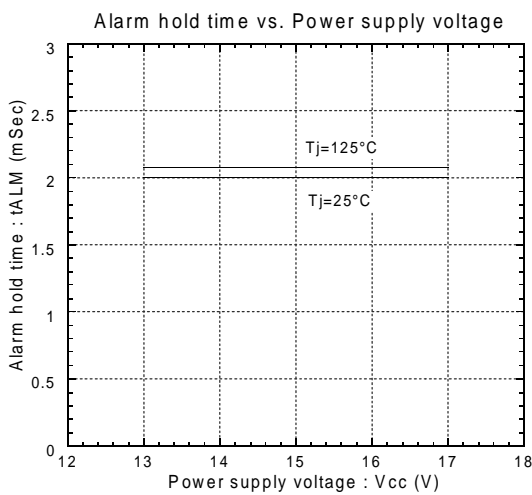
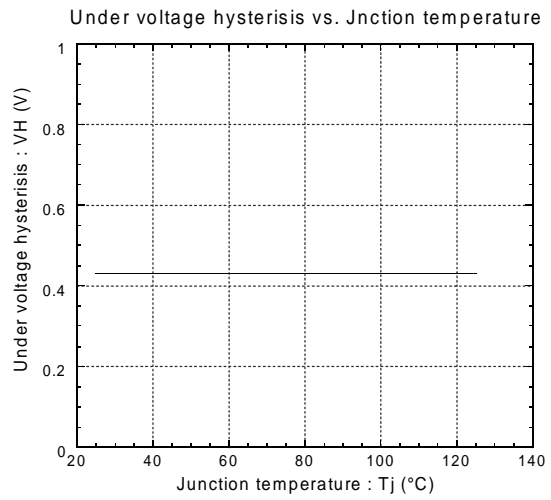
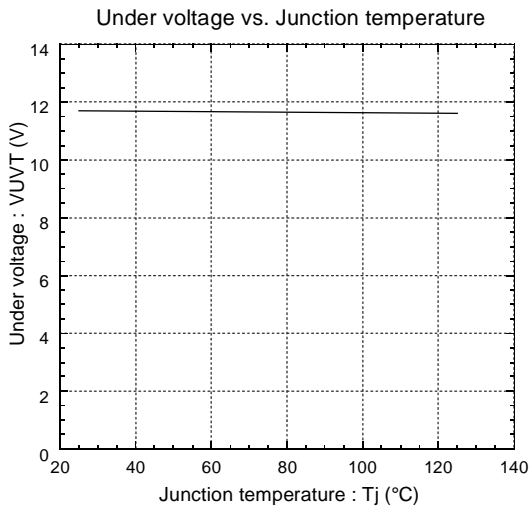
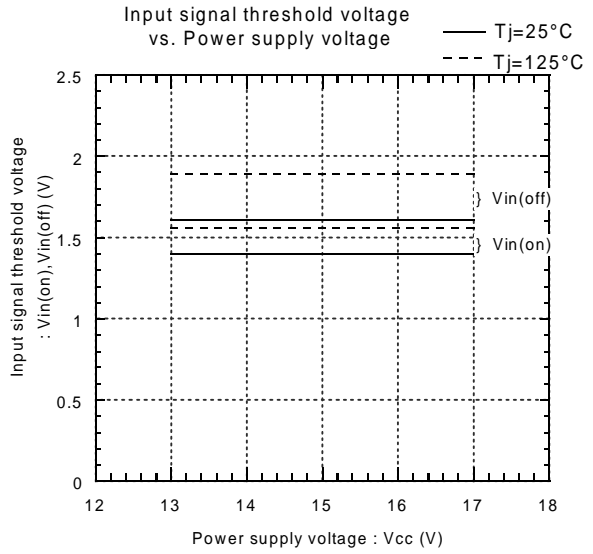
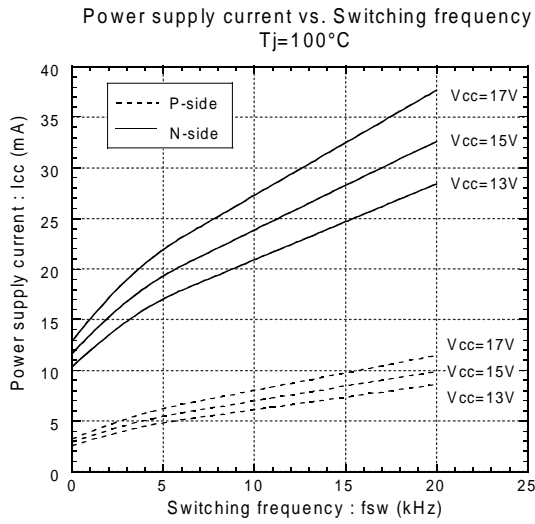

● Inverter

Collector current vs. Collector-Emmitter voltage
T_j=25°C

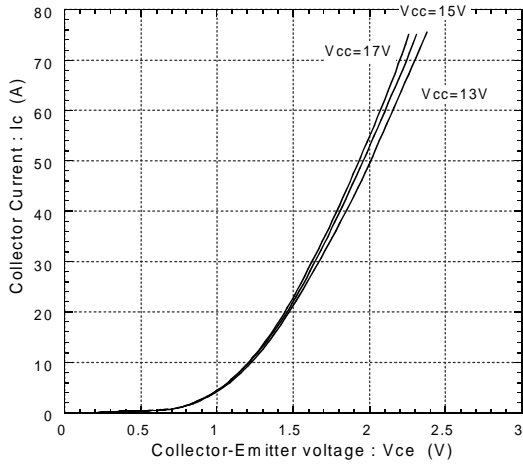

Collector current vs. Collector-Emmitter voltage
T_j=125°C

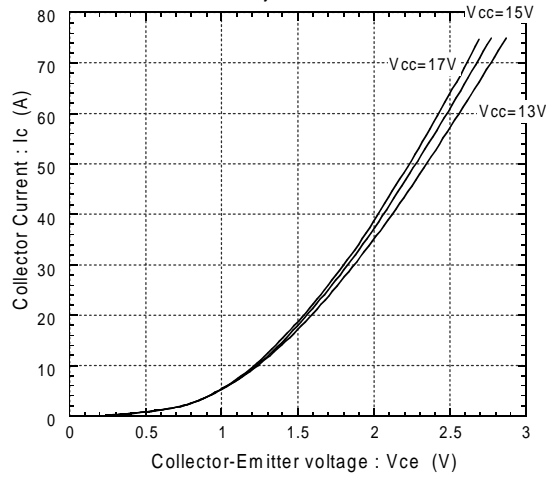

Switching time vs. Collector current
E_{dc}=600V, V_{cc}=15V, T_j=25°C

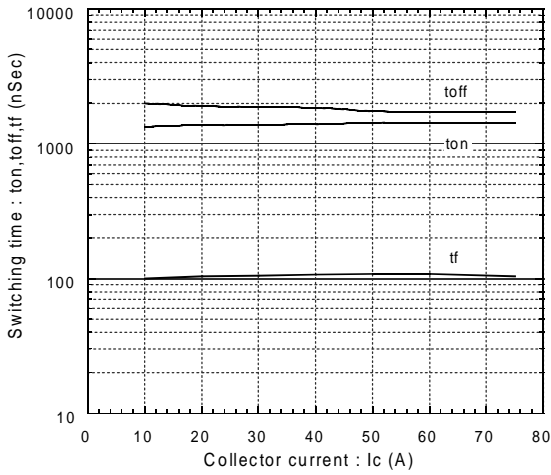

Switching time vs. Collector current
E_{dc}=600V, V_{cc}=15V, T_j=125°C

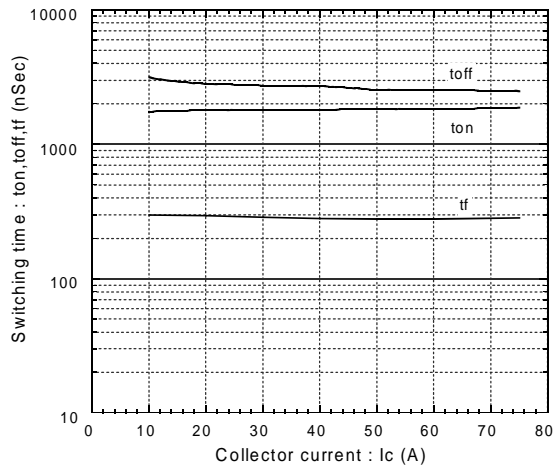

Forward current vs. Forward voltage

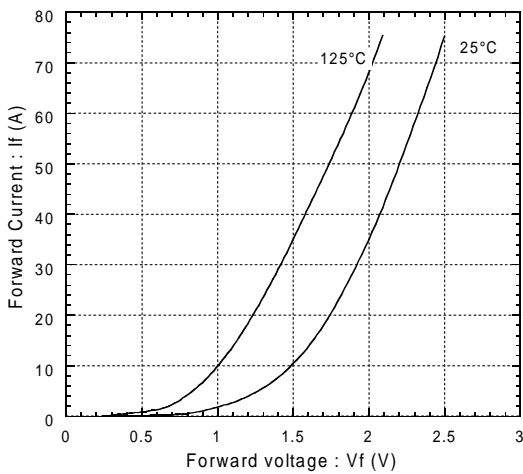

Reverse recovery characteristics
trr, Irr vs. IF

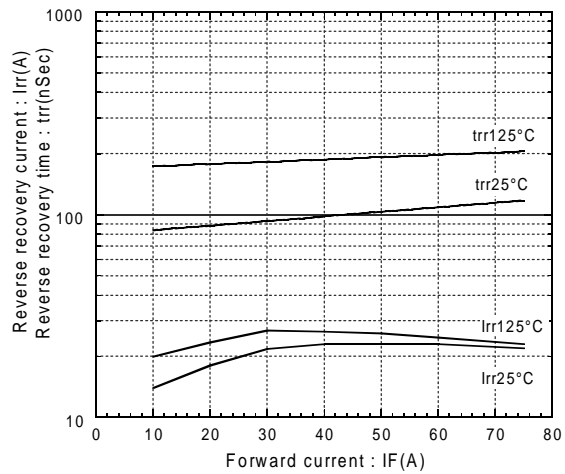

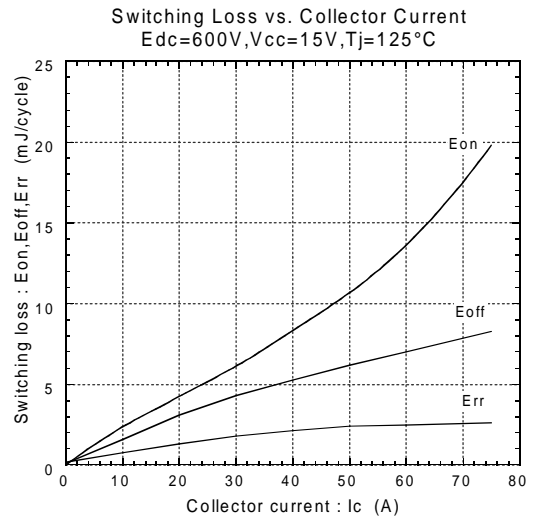
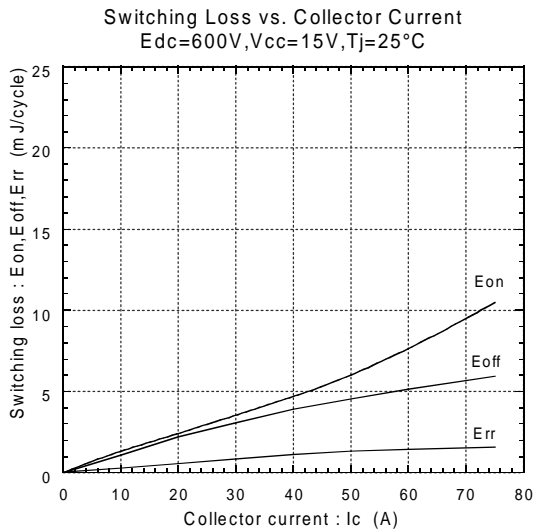
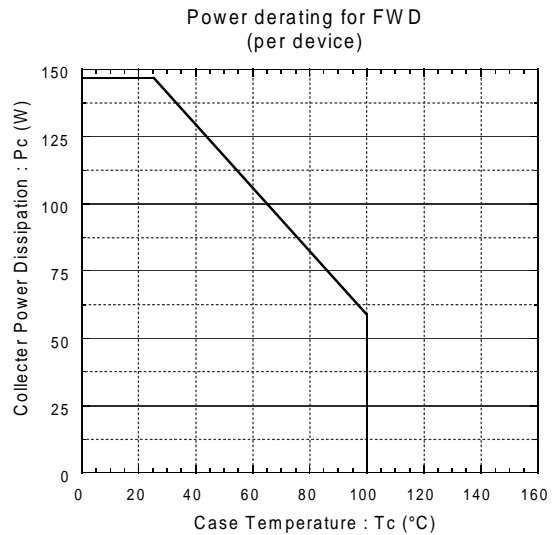
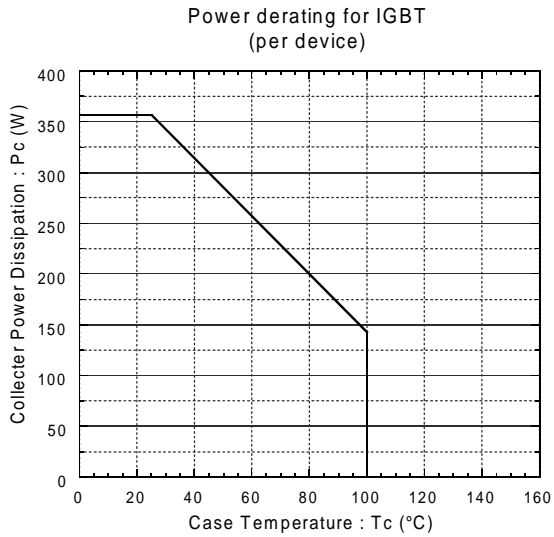
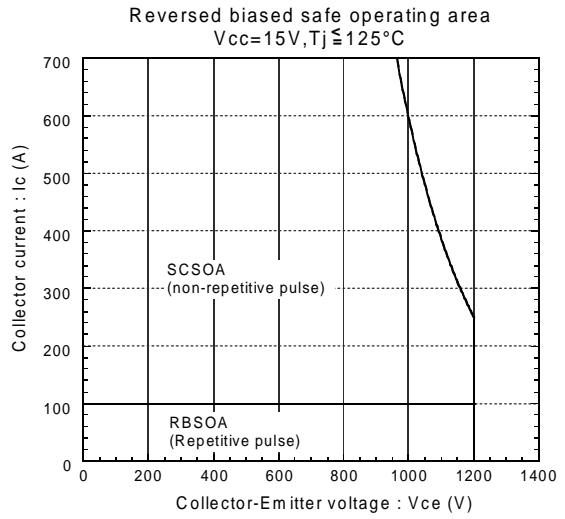
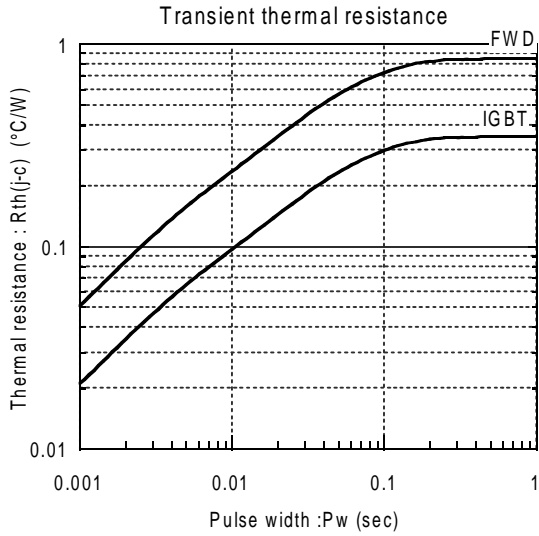

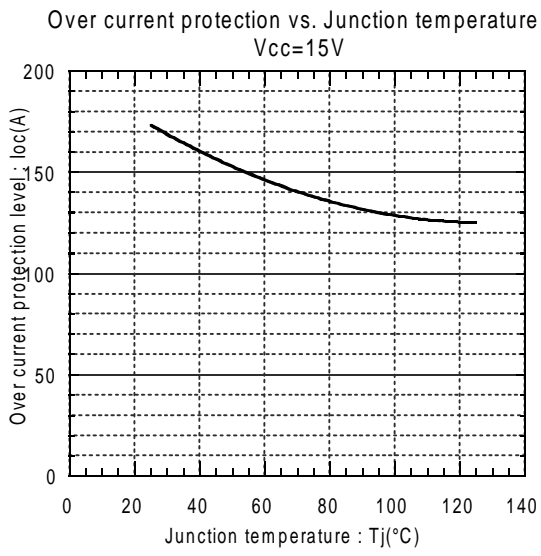

X-ON Electronics

Largest Supplier of Electrical and Electronic Components

Click to view similar products for [Fuji manufacturer:](#)

Other Similar products are found below :

[EW125JAGU-3P060B](#) [AG23-L2](#) [AH164-ZSWE3](#) [AH165-2SFLR11E3](#) [AH165-EG33](#) [AH165-J2D11C](#) [AH165-SGLW11E3](#) [AH165-TLO11H1](#) [AH16P-11](#) [AHX511-L](#) [DR22D0L-E4W](#) [AR22A5N-A0A0B](#) [AR22F0L-02H4R](#) [AR22G3R-01B](#) [AR22G4L-11E3W](#) [AR22G4L-20E3W](#) [AR22M0L-11E3Y](#) [AR22S2R-22W](#) [AR22V4R-01R](#) [AR22VGE-11R](#) [AR22WCR-551CB](#) [AR30E0L-10E3W](#) [AR30G4L-10E3W](#) [AR30PR-201B](#) [AR30V1R-11R](#) [AR30V2R-01R](#) [AR9C012-S](#) [AR9T511-H](#) [EG52AC/20-30MA](#) [BU-ECA2005L](#) [BW9FWCA-20A](#) [BZ0BFRA](#) [1TR0AK](#) [1TR0AM](#) [SA103RCUL/75](#) [SA203CUL/125](#) [SA203CUL/200](#) [SA203RCUL/125](#) [SG103CUL/40-CO](#) [EW125JAG-4P030K](#) [EW50RAGU-3P032K](#) [AG225-FW11](#) [AG23-LAE3-Y](#) [AH164-TLS11E3](#) [AH165-EG22](#) [AH165-SLY11E3](#) [AH165-TGLR22E3](#) [AH165-TLW11H1](#) [AH165-XBE](#) [AH165-ZGE](#)