

COMPACT HIGH POWER RELAY

1 POLE - 30A (for automotive applications)

FBR56 Series

■ **FEATURES**

- High power contact capacity
(carrying current: 40 A/10 minutes, 30 A/1 hour)
 - High heat resistance and extended operating voltage
 - Contact gap 0.4mm
 - RoHS compliant
- Please see page 7 for more information



■ **PARTNUMBER INFORMATION**

[Example] FBR56 N D12 - W1 - **
 (a) (b) (c) (d) (e)

| | | |
|-----|--------------------|---|
| (a) | Relay type | FBR56 : FBR56 Series (for 12V battery, contact gap 0.4mm) |
| (b) | Enclosure | Nil : Flux proof N : Plastic sealed type |
| (c) | Coil rated voltage | D12 : 6.....12 VDC Coil rating table at page 3 |
| (d) | Contact material | W1 : Silver-tin oxide indium Y : Silver-tin oxide |
| (e) | Special type | To be assigned custom specification |

Actual marking does not carry the type name: "FBR"
 E.g.: Ordering code: FBR56ND12-W1 Actual marking: 56ND12-W1

FBR56 SERIES

■ SPECIFICATION

| Item | FBR56 | | |
|--------------|------------------------------|---------------------|--|
| Contact Data | Configuration | | 1 form C |
| | Material | | Silver-tin oxide indium (-W1 type) Silver-tin oxide (-Y type) |
| | Voltage drop (resistance) | | Max.100 mV at 1A, 12VDC |
| | Contact rating | | 14VDC, 30A (locked motor load) 14 VDC, Inrush 27A, break 4A (motor free load) |
| | Max. carrying current | | 40A/10 minutes, 30A/1 hour (25 °C, 100% rated coil voltage) |
| | Max. inrush current | | 70A (reference) |
| | Max. switching voltage | | 16VDC (reference) |
| | Max. switching current | | 40A (reference) |
| | Min. switching load * | | 6 VDC, 1A |
| Life | Mechanical | | Min. 10 x 10 ⁶ operations |
| | Electrical | | Min. 100 x 10 ³ operations (locked motor load) Min. 1 x 10 ⁶ operations (motor free load) |
| Coil Data | Operating temperature range | | -40 °C to +85 °C (no frost) |
| | Storage temperature range | | -40 °C to +100 °C (no frost) |
| Timing Data | Operate (at nominal voltage) | | Max. 10 ms |
| | Release (at nominal voltage) | | Max. 5 ms |
| Other | Vibration resistance | | 10 to 55Hz double amplitude 1.5mm |
| | Shock | Misoperation | 100m/s ² |
| | | Endurance | 1,000m/s ² |
| Weight | | Approximately 9.4 g | |

* Minimum switching loads mentioned above are reference values. Please perform the confirmation test with actual load before production since reference values may vary according to switching frequencies, environmental conditions and expected reliability levels.

FBR56 SERIES

■ COIL RATING

| Coil Code | Rated Coil Voltage (VDC) | Coil Resistance +/- 10% (Ohm) | Must Operate Voltage (VDC) * | Must Release Voltage (VDC) * |
|-----------|--------------------------|-------------------------------|------------------------------|------------------------------|
| D06 | 6 | 42 | 3.6 (at 20 °C) | 0.5 (at 20 °C) |
| | | | 4.5 (at 85 °C) | 0.6 (at 85 °C) |
| D09 | 9 | 95 | 5.4 (at 20 °C) | 0.7 (at 20 °C) |
| | | | 6.8 (at 85 °C) | 0.8 (at 85 °C) |
| D12 | 12 | 170 | 7.3 (at 20 °C) | 1 (at 20 °C) |
| | | | 9.2 (at 85 °C) | 1.2 (at 85 °C) |

Note: All values in the table are valid for 20°C and zero contact current, unless otherwise stated.
* Specified operate values are valid for pulse wave voltage.

■ PRINCIPAL APPLICATIONS

| Application | | Normal load current | Life x 10 ³ | Recommended model (Example) |
|-----------------|---------------------|---|------------------------|-----------------------------|
| For 12V battery | Power windows | 20A tot 30A (switching at motor locking) | 100 | FBR56N () -Y |
| | Automatic door lock | 18A to 30A / 4 to 5 door (switching at motor locking) | 100 | FBR56N () - Y |
| | Intermittent wipers | Inrush 15A to 30A Break 2A to 8A (motor free) | 300 | FBR56N () - W1 |
| | Tilt-lock wheel | Inrush 15A Break 2.5A (motor free) | 100 | FBR56N () - Y |
| | Sunroof | 20A to 30A (switching at motor locking) | 100 | FBR56N () - Y |
| | Others | Car audio system, etc. | - | FBR56N () - Y |

■ CHARACTERISTIC DATA

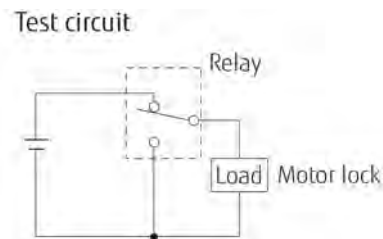
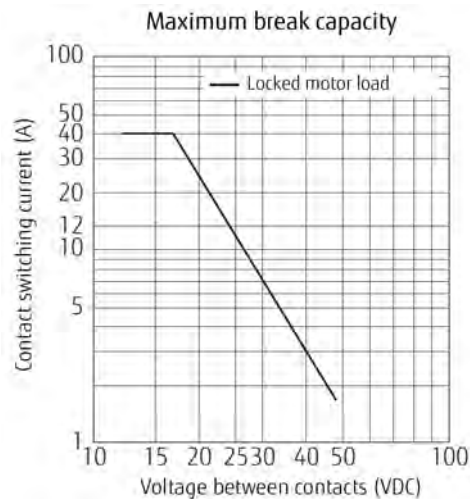

FBR56 SERIES

Coil temperature rise

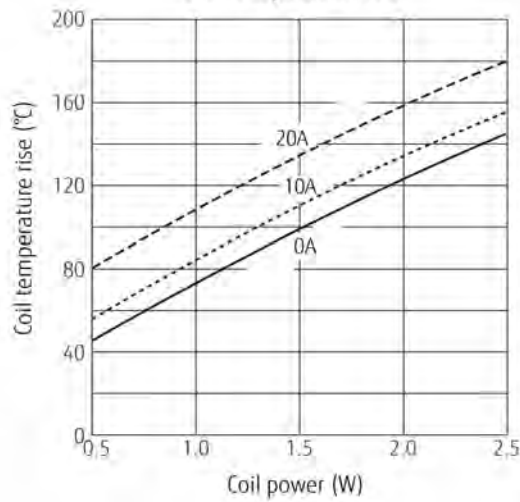

Operating coil voltage range (example)

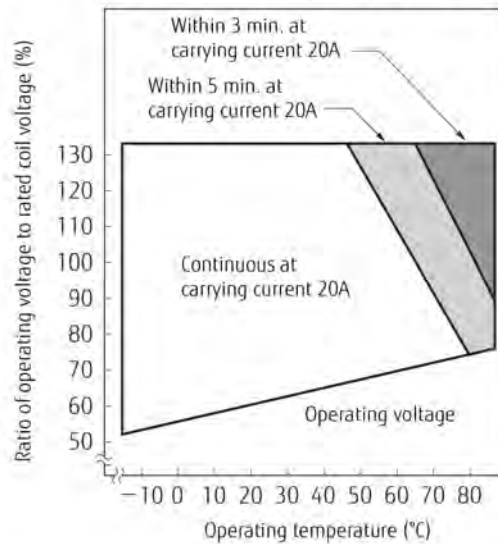

Vibration resistance characteristics

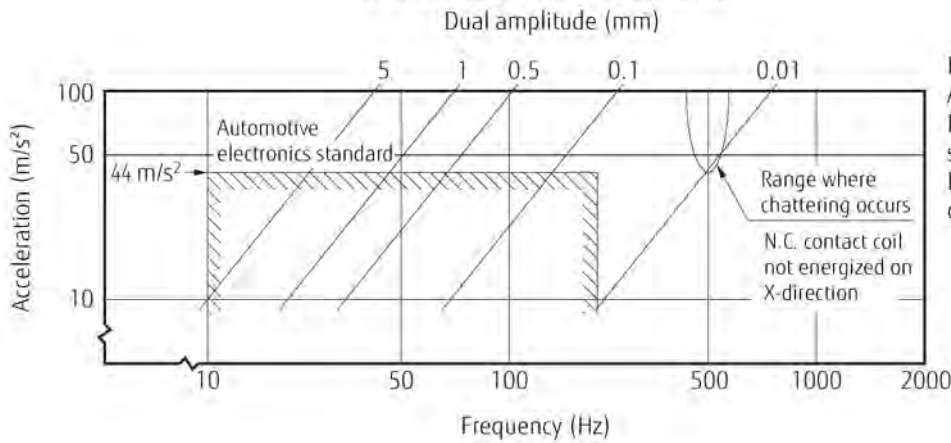

Frequency: 10~2000 Hz
 Acceleration: 100 m/s² max.
 Direction of vibration;
 see diagram below
 Detection level:
 chatter > 100 μs

Shock resistance characteristics

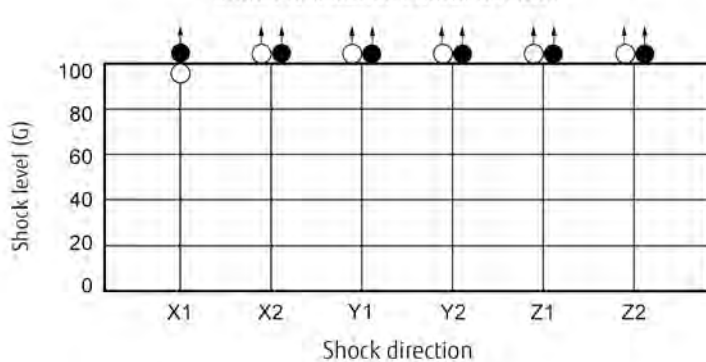

Shock application time: 11ms, half-sine wave
 Test condition: coil energized and de-energized
 Shock direction: see diagram below.
 Detection level: chatter > 100 μs

- : N.C. contact (coil de-energized)
- : N.O. contact (coil energized)

All directions ≥ 1,000 m/s²

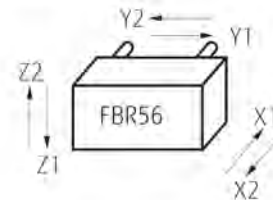

FBR56 SERIES

Life test (example)

(1) Motor lock

| Test item | Test circuit | Current wave form |
|--|--------------|-------------------|
| 20A, 14VDC Motor lock 200,000 operations minimum Contact material: Silver tin oxide indium | | |
| 30A, 14VDC Motor lock 100,000 operations minimum Contact material: Silver tin oxide indium | | |

(2) Motor free

| Test item | Test circuit | Current wave form |
|--|--------------|-------------------|
| Inrush 27A, Idle 4A 14VDC Motor free 100,000 operations minimum Contact material: Silver tin oxide indium | | |

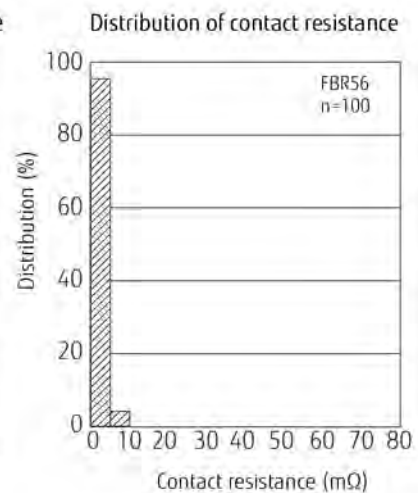
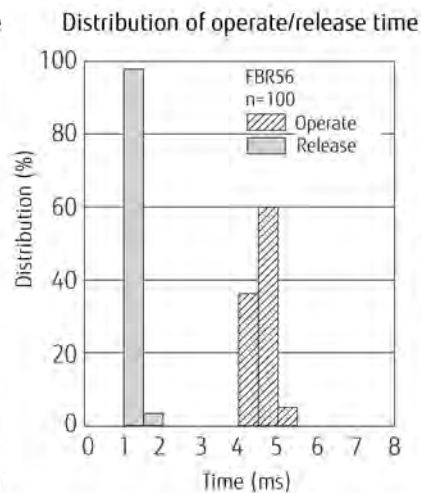
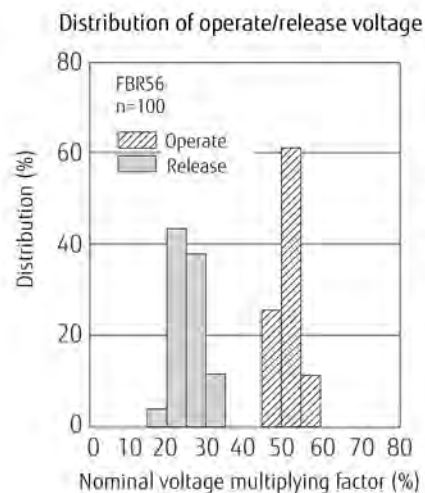

FBR56 SERIES

■ DIMENSIONS

● Dimensions

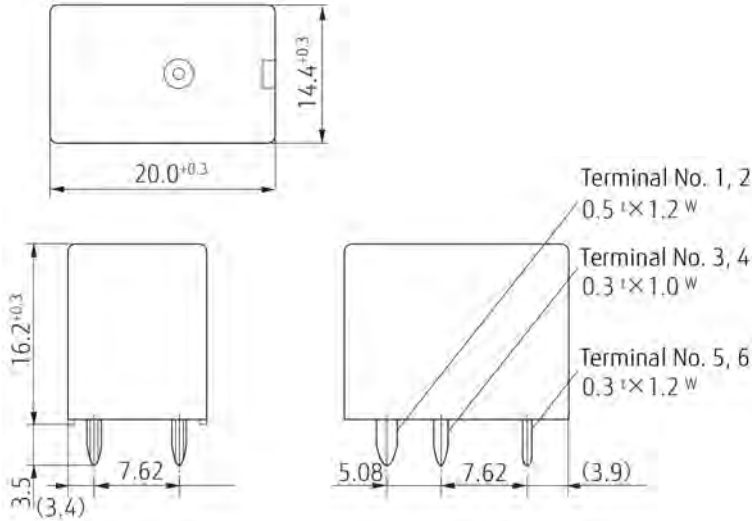

● Schematics (BOTTOM VIEW)

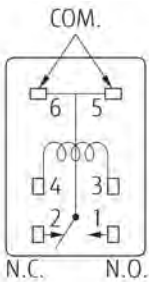

● PC board mounting hole layout (BOTTOM VIEW)

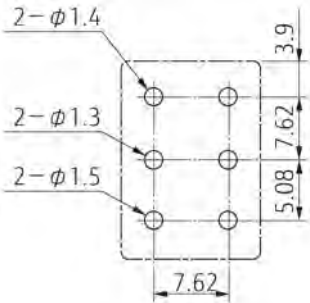

● Tube carrier

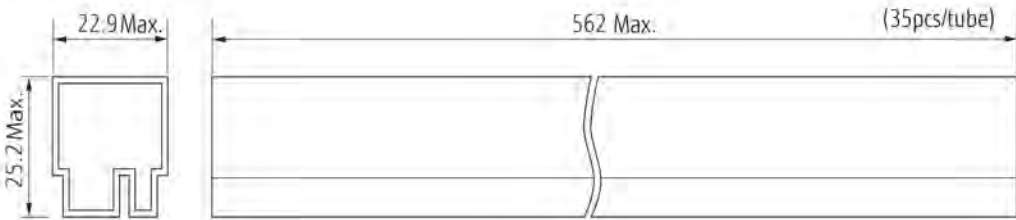

Unit: mm

RoHS Compliance and Lead Free Information

1. General Information

- All relays produced by Fujitsu Components are compliant with RoHS directive 2011/65/EU including amendments.
- Cadmium as used in electrical contacts is exempted from the RoHS directives. As per Annex III of directive 2011/65/EU.
- All relays are lead-free. Please refer to Lead-Free Status Info for older date codes at: <http://www.fujitsu.com/downloads/MICRO/fcai/relays/lead-free-letter.pdf>
- Lead free solder plating on relay terminals is Sn-3.0Ag-0.5Cu, unless otherwise specified. This material has been verified to be compatible with PbSn assembly process.

2. Recommended Lead Free Solder Condition

Flow Solder condition:

Pre-heating: maximum 120°C
Soldering: dip within 5 sec at
255°C ± 5°C solder bath
Relay must be cooled by air immediately
after soldering

Solder by Soldering Iron:

Soldering Iron 30-60W
Temperature: maximum 350-360°C
Duration: maximum 3 sec.

We highly recommend that you confirm your actual solder conditions

3. Moisture Sensitivity

- Moisture Sensitivity Level standard is not applicable to electromechanical relays, unless otherwise indicated.

4. Tin Whiskers

- Dipped SnAgCu solder is known as presenting a low risk to tin whisker development. No considerable length whisker was found by our in house test.

Fujitsu Components International Headquarter Offices

Japan

Fujitsu Component Limited
Gotanda-Chuo Building
3-5, Higashigotanda 2-chome, Shinagawa-ku
Tokyo 141, Japan
Tel: (81-3) 5449-7010
Fax: (81-3) 5449-2626
Email: promothq@ft.ed.fujitsu.com
Web: www.fcl.fujitsu.com

North and South America

Fujitsu Components America, Inc.
250 E. Caribbean Drive
Sunnyvale, CA 94089 U.S.A.
Tel: (1-408) 745-4900
Fax: (1-408) 745-4970
Email: components@us.fujitsu.com
Web: <http://us.fujitsu.com/components>

Europe

Fujitsu Components Europe B.V.
Diamantlaan 25
2132 WV Hoofddorp
Netherlands
Tel: (31-23) 5560910
Fax: (31-23) 5560950
Email: info@fceu.fujitsu.com
Web: emea.fujitsu.com/components/

Asia Pacific

Fujitsu Components Asia Ltd.
102E Pasir Panjang Road
#01-01 Citilink Warehouse Complex
Singapore 118529
Tel: (65) 6375-8560
Fax: (65) 6273-3021
Email: fcal@fcal.fujitsu.com
Web: <http://www.fujitsu.com/sg/services/micro/components/>

©2013 Fujitsu Components Europe B.V. All rights reserved. All trademarks or registered trademarks are the property of their respective owners.

The contents, data and information in this datasheet are provided by Fujitsu Component Ltd. as a service only to its user and only for general information purposes.

The use of the contents, data and information provided in this datasheet is at the users' own risk.

Fujitsu has assembled this datasheet with care and will endeavor to keep the contents, data and information correct, accurate, comprehensive, complete and up to date.

Fujitsu Components Europe B.V. and affiliated companies do however not accept any responsibility or liability on their behalf, nor on behalf of its employees, for any loss or damage, direct, indirect or consequential, with respect to this datasheet, its contents, data, and information and related graphics and the correctness, reliability, accuracy, comprehensiveness, usefulness, availability and completeness thereof.

Nor do Fujitsu Components Europe B.V. and affiliated companies accept on their behalf, nor on behalf of its employees, any responsibility or liability for any representation or warrant of any kind, express or implied, including warranties of any kind for merchantability or fitness for particular use, with respect to these datasheets, its contents, data, information and related graphics and the correctness, reliability, accuracy, comprehensiveness, usefulness, availability and completeness thereof. Rev. July 03, 2013

X-ON Electronics

Largest Supplier of Electrical and Electronic Components

Click to view similar products for [Automotive Relays](#) category:

Click to view products by [Fujitsu](#) manufacturer:

Other Similar products are found below :

[7-1414968-8](#) [7-1617345-6](#) [9-1617516-5](#) [G5CE1ASIDC12](#) [1393204-2](#) [1393302-3](#) [13Z99A115-0074](#) [1432872-1](#) [1617057-2](#) [1617058-6](#)
[1617518-5](#) [2-1617057-2](#) [2-1617057-6](#) [2-1617058-3](#) [CB1F-M-12V-H15](#) [898H-1AH-D-001-12VDC](#) [24198-1](#) [4-1617057-0](#) [41FZ-200ACG-](#)
[BSL](#) [5-1616920-2](#) [5-1617052-9](#) [5407-0011-HS](#) [CB1AF-M-12V-H59](#) [5-1617346-8](#) [103-1AH-C-12VDC](#) [V23134A1052X299](#) [6-1393302-1](#)
[897H-1AH-D-R1-U01-12VDC](#) [FTR-P3CP024W1-06](#) [1-1617057-8](#) [3-1393305-1](#) [5436-0001-HS](#) [V23086-R1851-A502](#) [898H-1AH-D1SW-](#)
[R1-12VDC](#) [RH4C1P2607](#) [RE031005](#) [V23134M0052G242](#) [23234B0001X001-EV-144](#) [V23234-A1001-X036](#) [2138602-1](#) [3-1904020-8](#)
[FBR56ND12-W1](#) [S11-1A-C1-12VDC](#) [S11-1A-C1-24VDC](#) [FRC2U-DC12](#) [FRC7A-S-DC24V](#) [FTR-P6GN012WA](#) [LQ-12](#) [2-1414939-2](#)
[FRC7C-S-DC12V](#)