

ULTRA MINIATURE RELAY

2 POLES - 2 A (Low Profile Signal Relay)

FTR-B3 Series

■ FEATURES

- DPDT 2C
- Ultra miniature low profile relay with high heat resistant material
- Height: 5.45mm, Weight: 0.85g, Mounting space: 87mm²
- Adopted superior contact spring for high frequency characteristic
- Comply with Telcordia / FCC standard
 - Isolation distance: min. 1.6mm
 - Dielectric strength between coil and contact: 1500VAC
 - Surge strength: 2500V
- Low power: Non-latching: 140mW (230mW at 24V)
Latching: 100mW (120mW at 24V)
- High reliable bifurcated gold overlay silver contact
- UL, CSA recognized. Confirms to IEC 60950, UL1950, EN60950. Spacing & high breakdown voltage (basic insulation, 150 working volts, pollution degree 2)
- RoHS compliant. Please see page 9 for more information
- Plastic sealed

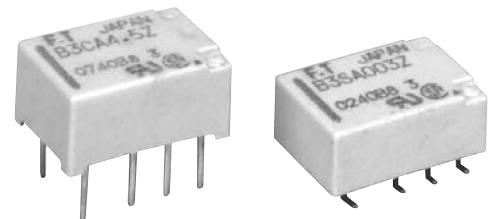

■ PARTNUMBER INFORMATION

[Example] FTR-B3 G B 012 Z - B10
 (a) (b) (c) (d) (e) (f)

(a)	Relay type	FTR-B3	: FTR-B3-Series
(b)	Terminal type	C G S	: Through hole : Surface mount : Surface mount, space saving
(c)	Coil type	A B	: Standard type : Latching type (1 coil)
(d)	Coil rated voltage	012	: 1.5.....24 VDC Coil rating table at page 3
(e)	Contact material	Z P	: Gold overlay silver nickel : Gold overlay silver palladium
(f)	Packaging	Nil B10	: Tube packaging : Tape&Peel packaging (only for surface mount type)

Remarks: Actual marking on relay would not carry code FTR and be as below:
 Ordering code: FTR-B3GB012Z-B10 Actual marking: B3GB012Z

FTR-B3 SERIES

■ SPECIFICATION

Item			Standard type	Latching type
			FTR-B3 () A	FTR-B3 () B
Contact Data	Configuration		2 form C	
	Construction		Bifurcated contacts	
	Material		Gold overlay silver nickel / Gold overlay silver palladium	
	Resistance (initial)		Max. 75 mΩ at 1 A, 6 VDC	
	Contact rating (resistive)		30VDC, 1A / 125VAC, 0.3A	
	Max. carrying current		2A	
	Max. switching voltage		250 VAC / 220VDC	
	Max. switching power		62.5VA / 30W	
	Min. switching load *		0.01mA, 10mVDC	
Life	Mechanical		Min. 50 x 10 ⁶ operations	Min. 20 x 10 ⁶ operations
	Electrical		Min. 100 x 10 ³ operations at 1A 30VDC (at 0.5Hz) Min. 100 x 10 ³ operations at 0.3A 125VAC (at 0.5Hz)	
Coil Data	Rated power		140mW - 230mW	100mW - 120mW
	Applied pulse width		-	Min. 10ms
	Operate power		80mW - 130mW	57mW - 68mW
	Operating temperature range		-40 °C to +85 °C (no frost)	
Timing Data	Operate (at nominal voltage)		Max. 3 ms (without bounce)	
	Release (at nominal voltage)		Max. 3 ms (without bounce)	
Insulation	Resistance (initial)		Min. 1,000MΩ at 500VDC	
	Dielectric strength	Open contacts	1,000VAC (50/60Hz) 1min	
		Adjacent contacts	1,000VAC (50/60Hz) 1min.	
		Contacts to coil	1,500VAC (50/60Hz) 1min	
	Surge strength	Contacts to coil	2,500V, 2 x 10μs standard wave	
	Clearance	Open contacts	0.28 mm	
		Adjacent contacts	1.0 mm	
		Contacts to coil	1.0 mm	
	Creepage	Open contacts	0.28 mm	
		Adjacent contacts	1.0 mm	
Contacts to coil		1.60 mm		
Other	Vibration resistance	Misoperation	10 to 55 to 10Hz single amplitude 1.65mm	
		Endurance	10 to 55 to 10Hz single amplitude 2.5mm	
	Shock	Misoperation	750m/s ²	
		Endurance	1,000m/s ²	
	Weight	Approximately 0.85 g		
Sealing	RT III (plastic sealed)			

* Minimum switching loads mentioned above are reference values. Please perform the confirmation test with actual load before production since reference values may vary according to switching frequencies, environmental conditions and expected reliability levels.

FTR-B3 SERIES

■ COIL RATING

Standard type

Coil Code	Rated Coil Voltage (VDC)	Coil Resistance +/- 10% (Ohm)	Must Operate Voltage (VDC) *	Must Release Voltage (VDC) *	Rated Power (mW)
1.5	1.5	16.1	1.13	0.15	140
003	3	64.3	2.25	0.3	
4.5	4.5	145	3.38	0.45	
006	6	257	4.5	0.6	
009	9	579	6.75	0.9	
012	12	1,028	9.0	1.2	230
024	24	2,504	18.0	2.4	

Latching type (1 coil)

Coil Code	Rated Coil Voltage (VDC)	Coil Resistance +/- 10% (Ohm)	Set Voltage (VDC) *	Reset Voltage (VDC) *	Set/Reset current (mA)	Rated Power (mW)
1.5	1.5	22.5	+1.13	-1.13	50	100
003	3	90	+2.25	-2.25	25	
4.5	4.5	203	+3.38	-3.38	17	
006	6	360	+4.5	-4.5	13	
009	9	810	+6.75	-6.75	8	
012	12	1,440	+9.0	-9.0	6	120
024	24	4,800	+18.0	-18.0	4	

Note: All values in the table are valid for 20°C and zero contact current.

* Specified operate values are valid for pulse wave voltage.

■ SAFETY STANDARDS

Type	Compliance	Contact rating
UL	UL 508	Flammability: UL 94-V0 (plastics)
	E 63615	0.5A, 125VAC (resistive) 0.3A, 110VDC (General use)
CSA	C22.2 No. 14 LR 40304-58	2A, 30VDC (General use)

Comply with Telcordia specifications and FCC part 68 and meet BSI EN60950-1:
Marking only for UL, CSA

FTR-B3 SERIES

CHARACTERISTIC DATA (Reference)

- Standard type

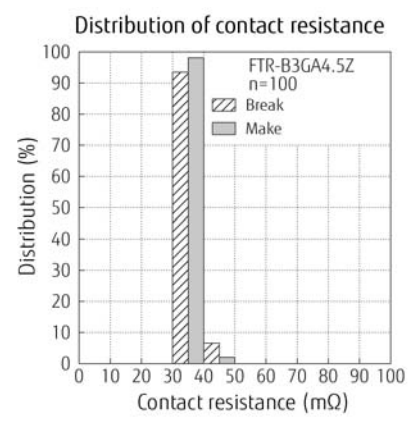
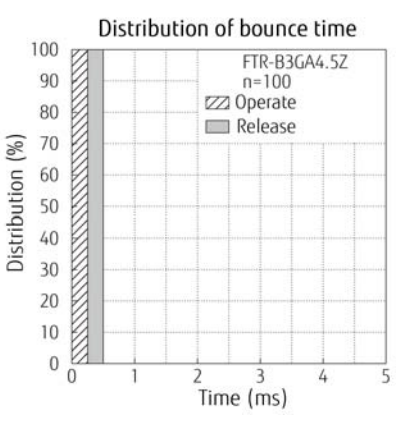
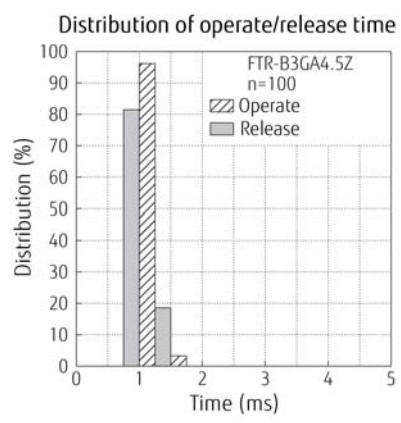
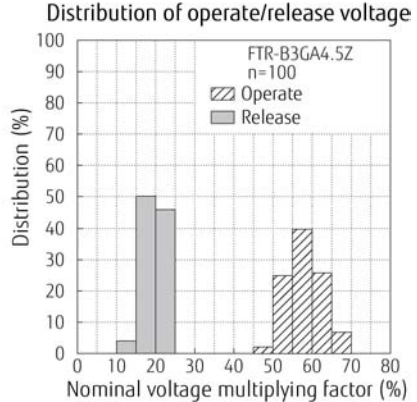
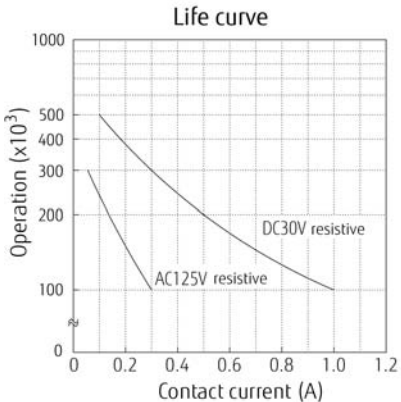
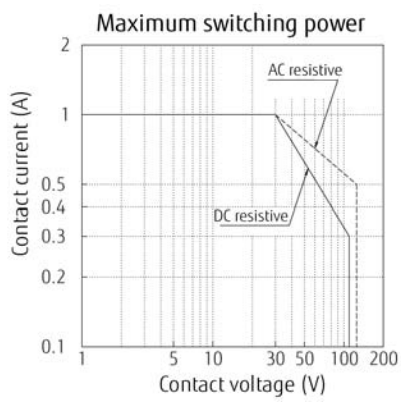
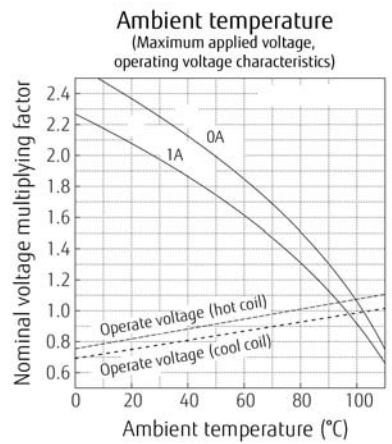
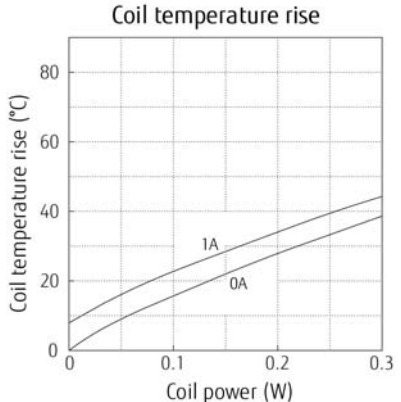
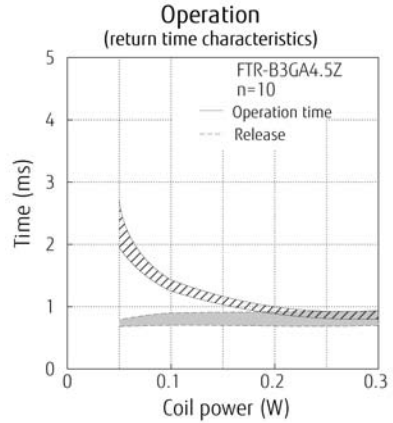

FTR-B3 SERIES

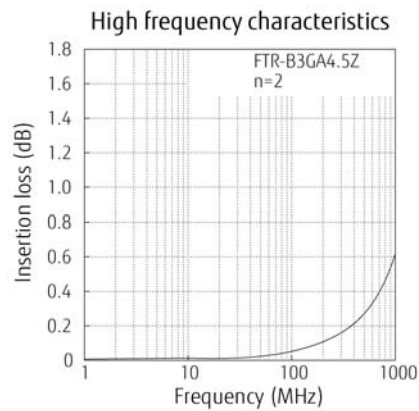
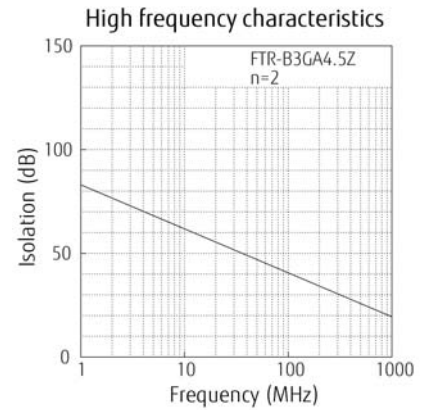
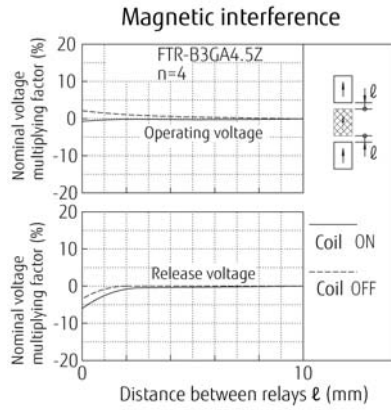
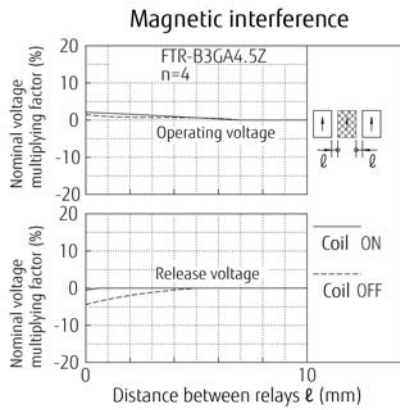

- Latching type

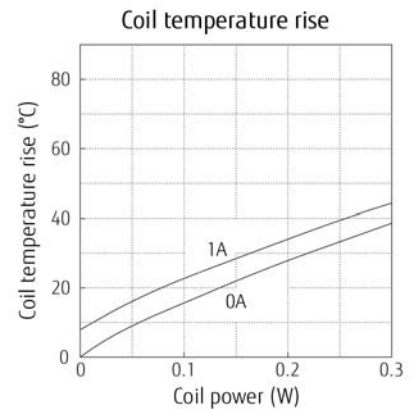
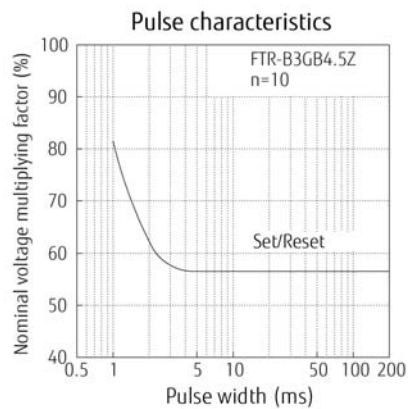
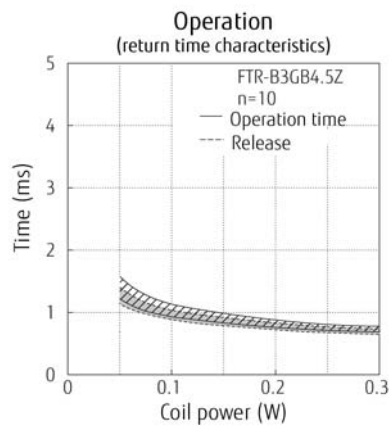

FTR-B3 SERIES

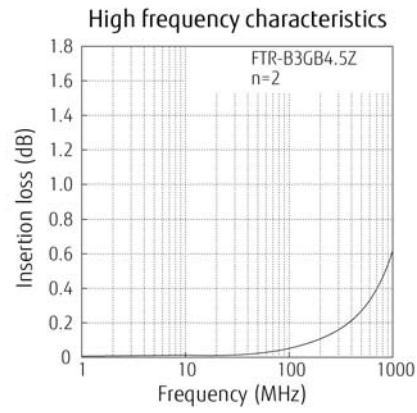
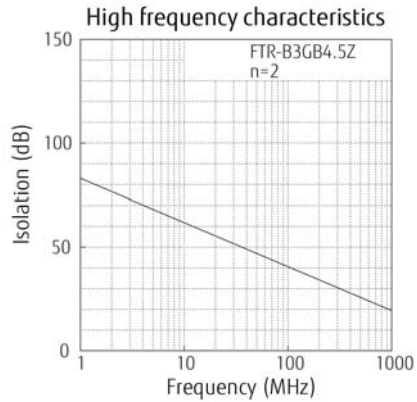
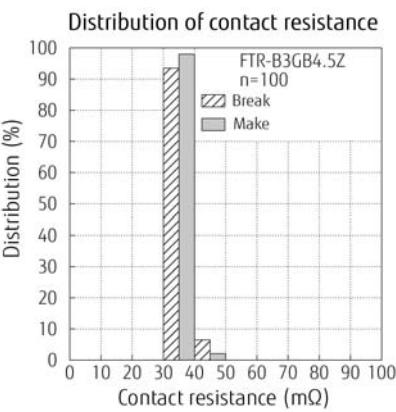
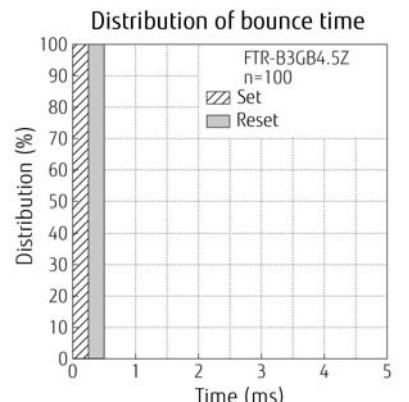
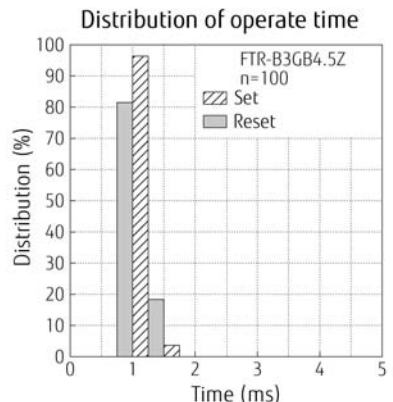
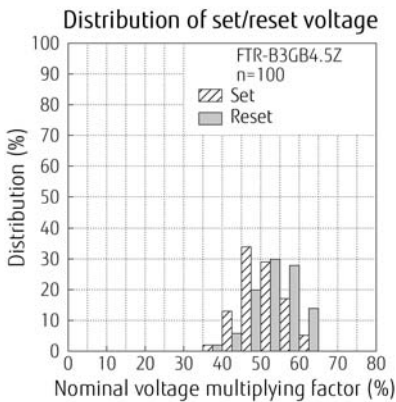
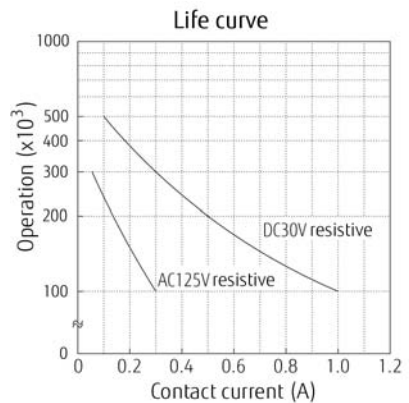
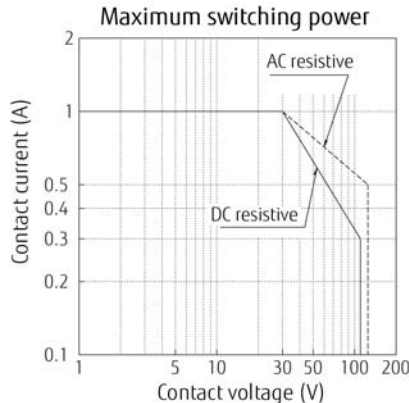
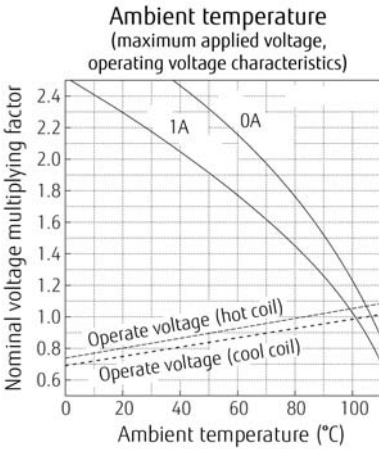

FTR-B3 SERIES

■ DIMENSIONS

FTR-B3C - Through hole type

- Dimensions

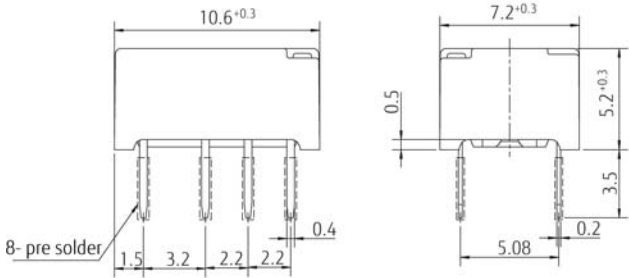

- Schematics *
(BOTTOM VIEW)

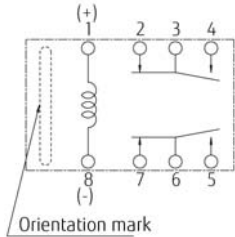

- PC board mounting hole layout
(BOTTOM VIEW)

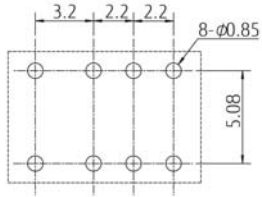

FTR-B3G - Surface mount type

- Dimensions

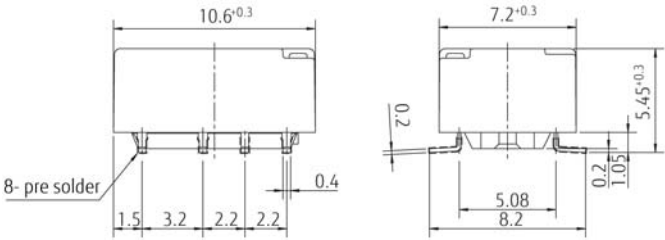

- Schematics *
(TOP VIEW)

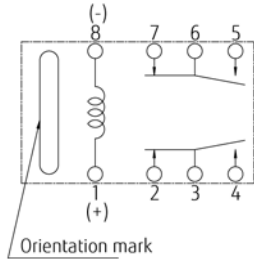

- PC board mounting pad layout
(TOP VIEW)

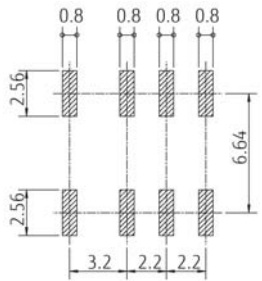

FTR-B3S - Space saving type

- Dimensions

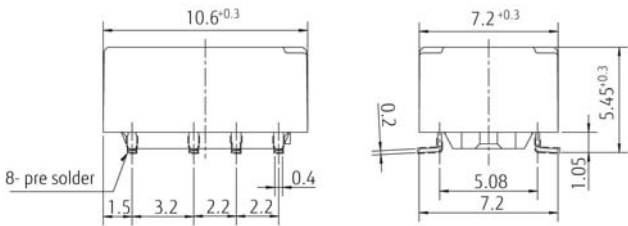

- Schematics *
(TOP VIEW)

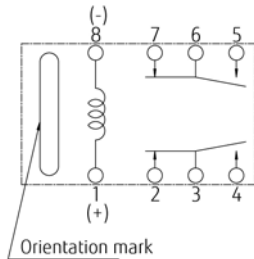

- PC board mounting pad layout
(TOP VIEW)

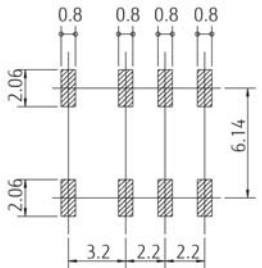

* Indicates reset state for latching relays (FTR-B3CB, FTR-B3GB and FTR-B3SB versions)
 Indicates non-operate state for standard relays (FTR-B3CA, FTR-B3GA and FTR-B3SA versions)

Unit: mm

■ COIL POLARITY LATCHING TYPE

Coil terminal	1	8
Set	+	-
Reset	-	+

■ RECOMMENDED SOLDERING CONDITIONS FOR SMT (SEE PAGE 9) (TEMPERATURE PROFILE)

Notes:

1. Temperature profiles on page 9 show the temperature of PC board surface.
2. Please perform soldering test with your actual PC board before mass production, since the temperatures of PC board surfaces vary according to the size of PC board, status of parts mounting and heating method.

■ PRECAUTIONS

- For details on general precautions, refer to the section on technical descriptions.
- Since this is a polarized relay, follow the instructions of the internal wiring diagram for the \pm connections of the coil.
- Note that the terminal layout and internal wiring of the surface mount relay are a top view.
- SMT versions of the FTR-B3 relays will be shipped in "dry pack".

■ PACKAGING SPECIFICATIONS

● Packaging method

- Packaging standard: JIS C 0806
- Taping type: TB 1612
- Reel type: R16D
- Quantity of 1 reel: 1000 pieces

● Packaging orientation code: B

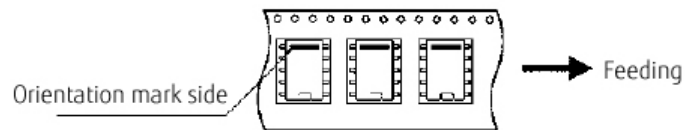

● Reel dimensions

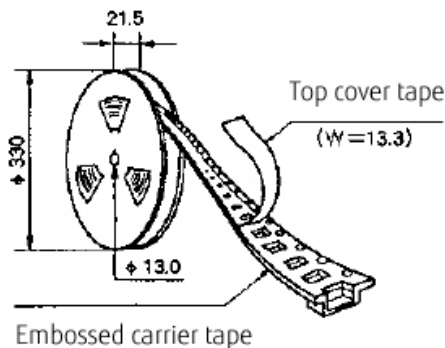

● Tape dimensions

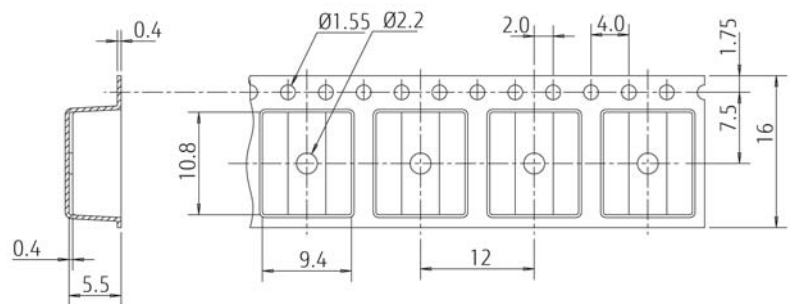

Unit: mm

Note:

Relays are sold in 1000 pieces per box. Minimum order quantity is 1000 pieces for tube and tape & reel packing.

RoHS Compliance and Lead Free Information

1. General Information

- All relays produced by Fujitsu Components are compliant with RoHS directive 2011/65/EU including amendments.
- Cadmium as used in electrical contacts is exempted from the RoHS directives.
As per Annex III of directive 2011/65/EU.
- All relays are lead-free. Please refer to Lead-Free Status Info for older date codes at:
<http://www.fujitsu.com/downloads/MICRO/fcai/relays/lead-free-letter.pdf>
- Lead free solder plating on relay terminals is Sn-3.0Ag-0.5Cu, unless otherwise specified.
This material has been verified to be compatible with PbSn assembly process.

2. Recommended Lead Free Solder Condition

- Recommended solder Sn-3.0Ag-0.5Cu.

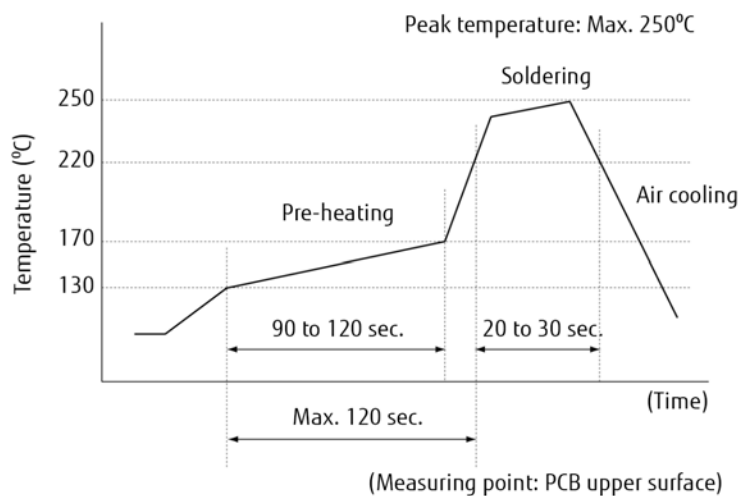

Flow Solder Condition:

Pre-heating: maximum 120°C
within 90 sec.

Soldering: dip within 5 sec. at
255°C ± 5°C solder bath

Relay must be cooled by air immediately
after soldering

Solder by Soldering Iron:

Soldering Iron 30-60W

Temperature: maximum 350-360°C

Duration: maximum 3 sec.

We highly recommend that you confirm your actual solder conditions

3. Moisture Sensitivity

- Moisture Sensitivity Level standard is not applicable to electromechanical relays, unless otherwise indicated.

4. Tin Whiskers

- Dipped SnAgCu solder is known as presenting a low risk to tin whisker development. No considerable length whisker was found by our in house test.

Fujitsu Components International Headquarter Offices

Japan

Fujitsu Component Limited
Gotanda-Chuo Building
3-5, Higashigotanda 2-chome, Shinagawa-ku
Tokyo 141, Japan
Tel: (81-3) 5449-7010
Fax: (81-3) 5449-2626
Email: promothq@ft.ed.fujitsu.com
Web: www.fcl.fujitsu.com

North and South America

Fujitsu Components America, Inc.
250 E. Caribbean Drive
Sunnyvale, CA 94089 U.S.A.
Tel: (1-408) 745-4900
Fax: (1-408) 745-4970
Email: components@us.fujitsu.com
Web: <http://us.fujitsu.com/components>

Europe

Fujitsu Components Europe B.V.
Diamantlaan 25
2132 WV Hoofddorp
Netherlands
Tel: (31-23) 5560910
Fax: (31-23) 5560950
Email: info@fceu.fujitsu.com
Web: emea.fujitsu.com/components/

Asia Pacific

Fujitsu Components Asia Ltd.
102E Pasir Panjang Road
#01-01 Citilink Warehouse Complex
Singapore 118529
Tel: (65) 6375-8560
Fax: (65) 6273-3021
Email: fcalfcal.fujitsu.com
Web: <http://www.fujitsu.com/sg/services/micro/components/>

©2014 Fujitsu Components Europe B.V. All rights reserved. All trademarks or registered trademarks are the property of their respective owners.

The contents, data and information in this datasheet are provided by Fujitsu Component Ltd. as a service only to its user and only for general information purposes.

The use of the contents, data and information provided in this datasheet is at the users' own risk.

Fujitsu has assembled this datasheet with care and will endeavor to keep the contents, data and information correct, accurate, comprehensive, complete and up to date.

Fujitsu Components Europe B.V. and affiliated companies do however not accept any responsibility or liability on their behalf, nor on behalf of its employees, for any loss or damage, direct, indirect or consequential, with respect to this datasheet, its contents, data, and information and related graphics and the correctness, reliability, accuracy, comprehensiveness, usefulness, availability and completeness thereof.

Nor do Fujitsu Components Europe B.V. and affiliated companies accept on their behalf, nor on behalf of its employees, any responsibility or liability for any representation or warrant of any kind, express or implied, including warranties of any kind for merchantability or fitness for particular use, with respect to these datasheets, its contents, data, information and related graphics and the correctness, reliability, accuracy, comprehensiveness, usefulness, availability and completeness thereof. Rev. December 16, 2014

X-ON Electronics

Largest Supplier of Electrical and Electronic Components

Click to view similar products for [High Frequency / RF Relays](#) category:

Click to view products by [Fujitsu](#) manufacturer:

Other Similar products are found below :

[134M4-26](#) [134YZM4-12](#) [136CM9-5](#) [ER136CZM9-5B](#) [ER412DYM-12B](#) [ARA200A4HM01](#) [3SBH1020A2](#) [400-192-10](#) [412TM-18](#)
[ARN12A12](#) [422DM-26](#) [411T-12](#) [LB363-100-5](#) [D3210](#) [ARN10A12](#) [ER116C-26A](#) [ER114ZM4-5A/SQ](#) [ER114ZM4-12A/SQ](#) [ER412-26B/Q](#)
[ER134DYZ-12A](#) [36 AT5](#) [25-200ZA](#) [36 T5](#) [48-000ZA](#) [27 T5](#) [24-200ZA](#) [27 T5](#) [26-200ZA](#) [27 T5](#) [28-200ZA](#) [ER411DM4-12A/SQ](#)
[732-5/Q](#) [R591362640](#) [R591723400](#) [R595867120](#) [HF3 02](#) [R594873417](#) [R595863115](#) [IM43TS](#) [IMB03CTS](#) [732TN-26](#) [1-1462038-1](#)
[IMB06CTS](#) [1462051-5](#) [1462050-1](#) [1462050-2](#) [G6K-2F-RF-S-DC5](#) [ARE10A4H](#) [ARE1024](#) [ARS1012](#) [ARJ22A12](#) [ARS104H](#) [FTR-](#)
[B3GA4.5Z-B10](#) [FTR-B3CA024Z](#) [1-1462039-7](#)