

ULTRA MINIATURE 2-POLES 2A (LOW PROFILE SIGNAL RELAY) FTR-B3 SERIES

RoHS compliant



■ FEATURES

- DPDT 2C
- Ultra miniature low profile relay with high heat resistant material
- Height: 5.45mm, Weight: 0.85g, Mounting space: 87mm²
- Adopted superior contact spring for high frequency characteristic
- Comply with Telcordia / FCC standard
 - Isolation distance: min. 1.6mm
 - Dielectric strength between coil and contact: 1500VAC
 - Surge strength: 2500V
- Low power: Non-latch: 140mW (230mW at 24V)
Latch: 100mW (120mW at 24V)
- High reliable bifurcated gold overlay silver contact
- UL, CSA recognized. Confirms to IEC 60950, UL1950, EN60950. Spacing & high breakdown voltage (Basic insulation, 150 working volts, pollution degree 2).
- RoHS compliant since date code: 0431B8
Please see page 11 and 12 for more information

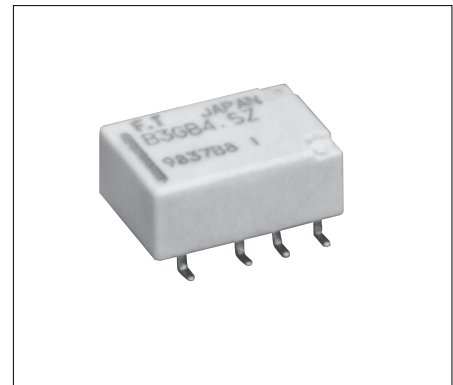

FTR-B3 Series

■ ORDERING INFORMATION

[Example] FTR-B3 G B 012 Z -B 10
 (a) (b) (c) (d) (e) (f) (g)

(a)	Series Name	FTR-B3 series
(b)	Terminal Type	C: through hole G: surface mount S: surface mount, space saving
(c)	Operation Function	A: standard type B: latching type (1 coil)
(d)	Rated voltage of coil	1.5 : 1.5 VDC 009 : 9VDC 003 : 3VDC 012: 12 VDC 4.5 : 4.5VDC 024 : 24VDC 006: 6VDC
(e)	Contact material	Z: gold overlay silver nickel (standard) P: gold overlay silver palladium
(f)	Relay enclosing direction*	B: standard enclosing direction
(g)	Number of relays per reel*	10: 1,000 (standard)

Remarks: Actual marking on relay would not carry code FTR and be as below:

Ordering code: FTR-B3GA012Z-B10

Actual marking: B3GA012Z

Note: *: - Only surface mount types (G and S) are applicable
 - All relays are packaged in tubes unless P/N ends with -B10

■ PART NUMBERS

Standard type

Ordering Part Number	Series	Terminal Type	Operation	Coil Voltage	Contact Material		
FTR-B3CA1.5Z	FTR-B3	C: through hole	A: mono-stable (standard type)	1.5	Z: Au-Ag-Ni P: Au-Ag-Pd		
FTR-B3CA003Z				3			
FTR-B3CA4.5Z				4.5			
FTR-B3CA006Z				6			
FTR-B3CA009Z				9			
FTR-B3CA012Z				12			
FTR-B3CA024Z				24			
FTR-B3GA1.5Z		G: surface mount		A: mono-stable (standard type)		1.5	
FTR-B3GA003Z						3	
FTR-B3GA4.5Z						4.5	
FTR-B3GA006Z						6	
FTR-B3GA009Z						9	
FTR-B3GA012Z						12	
FTR-B3GA024Z						24	
FTR-B3SA1.5Z		S: space saving surface mount				A: mono-stable (standard type)	1.5
FTR-B3SA003Z							3
FTR-B3SA4.5Z							4.5
FTR-B3SA006Z							6
FTR-B3SA009Z							9
FTR-B3SA012Z							12
FTR-B3SA024Z							24

FTR-B3 Series

Latching type (1 coil)

Ordering Part Number	Series	Terminal Type	Operation	Coil Voltage	Contact Material
FTR-B3CB1.5Z	FTR-B3	C: through hole	B: latching	1.5	Z: Au-Ag-Ni P: Au-Ag-Pd
FTR-B3CB003Z				3	
FTR-B3CB4.5Z				4.5	
FTR-B3CB006Z				6	
FTR-B3CB009Z				9	
FTR-B3CB012Z				12	
FTR-B3CB024Z				24	
FTR-B3GB1.5Z				G: surface mount	
FTR-B3GB003Z		3			
FTR-B3GB4.5Z		4.5			
FTR-B3GB006Z		6			
FTR-B3GB009Z		9			
FTR-B3GB012Z		12			
FTR-B3GB024Z		24			
FTR-B3SB1.5Z		S: space saving surface mount			
FTR-B3SB003Z				3	
FTR-B3SB4.5Z				4.5	
FTR-B3SB006Z				6	
FTR-B3SB009Z				9	
FTR-B3SB012Z				12	
FTR-B3SB024Z				24	

■ COIL DATA CHART

Standard type

Coil Voltage	Nominal Voltage (VDC)	Max. Coil Voltage* ¹	Coil Resistance (±10%)	Must Operate Voltage* ²	Must Release Voltage* ²	Nominal Power (mW)
1.5	1.5	3.53 VDC	16.1 Ω	1.13 VDC	0.15 VDC	140
003	3	7.05 VDC	64.3 Ω	2.25 VDC	0.3 VDC	
4.5	4.5	10.58 VDC	145 Ω	3.38 VDC	0.45 VDC	
006	6	14.10 VDC	257 Ω	4.5 VDC	0.6 VDC	
009	9	21.15 VDC	579 Ω	6.75 VDC	0.9 VDC	
012	12	28.20 VDC	1,028 Ω	9.0 VDC	1.2 VDC	
024	24	56.40 VDC	2,504 Ω	18.0 VDC	2.4 VDC	230

Latching type (1 coil)

Coil Voltage	Nominal Voltage (VDC)	Max. Coil Voltage* ¹	Coil Resistance (±10%)	Must Operate Voltage* ²	Must Release Voltage* ²	Nominal Power (mW)
1.5	1.5	3.53 VDC	22.5 Ω	1.13 VDC	-0.13 VDC	100
003	3	7.05 VDC	90 Ω	2.25 VDC	-2.25 VDC	
4.5	4.5	10.58 VDC	203 Ω	3.38 VDC	-3.38 VDC	
006	6	14.10 VDC	360 Ω	4.5 VDC	-4.5 VDC	
009	9	21.15 VDC	810 Ω	6.75 VDC	-6.75 VDC	
012	12	28.20 VDC	1,440 Ω	9.0 VDC	-9.0 VDC	
024	24	56.40 VDC	4,800 Ω	18.0 VDC	-18.0 VDC	120

Note: All values in the table are measured at 20°C.

*1: No contact current at 20°C. Please see 'operating range' data for other conditions.

*2: Specified values are subject to pulse wave voltage.

FTR-B3 Series

■ SPECIFICATIONS

Item		Standard Type		Latching Type	
		FTR-B3 () A		FTR-B3 () B	
Contact	Arrangement		2Form C		
	Contact material		Gold overlay silver nickel / Gold overlay silver palladium		
	Contact type		Bifurcated contacts (cross-bar)		
	Contact resistance (initial value)		75mΩ , maximum (6VDC, 1A)		
	Contact rating		30VDC 1A /125VAC 0.3A (resistive)		
	Maximum carrying/switching current		2A		
	Maximum switching power		62.5 VA / 30W		
	Maximum switching voltage		250 VAC, 220 VDC		
	Minimum switching load *1		10mVDC, 0.01mA*1		
Coil	Nominal power (at 20° C)		140mW to 230mW	100mW to 120mW	
	Operate power (at 20° C)		80mW to 130mW	57mW to 68mW	
	Operating temperature (no frost)		-40° C to +85° C		
Time Value	Operate (at nominal voltage, without bounce)		3ms maximum		
	Release (at nominal voltage, without bounce)		3ms maximum		
Life	Mechanical		50 x 10 ⁶ ops. min. (at 3Hz)	20 x 10 ⁶ ops. min. (at 3Hz)	
	Electrical (resistive load)		100 x 10 ³ operations min. at 1A 30VDC (at 0.5Hz) 100 x 10 ³ operations min. at 0.3A 125VDC (at 0.5Hz)		
Other	Vibration resistance	Malfunction	10 to 55 Hz at double amplitude of 3.3mm		
		Endurance	10 to 55 Hz at double amplitude of 5mm		
	Shock resistance	Malfunction	Min. 750 m/s ²		
		Endurance	Min. 1000 m/s ²		
	Weight		Approximately 0.8g		

*1 Minimum switching loads mentioned above are reference values. Please perform the confirmation test with the actual load before production since reference values may vary according to switching frequencies, environmental conditions and expected reliability levels.

■ INSULATION

Item		FTR-B3
Resistance (initial) (500 VDC)		Minimum 1,000 MΩ 1 min.
Dielectric Strength	open contacts	1,000 VAC (50/60 Hz) 1 min.
	coil and contacts	1,500 VAC (50/60 Hz) 1 min.
	adjacent contacts	1,000 VAC (50/60 Hz) 1 min.
Surge Voltage (coil and contact)		2,500 V 2 x 10 μ s standard wave
Clearance	adjacent contacts	1.0mm
	open contacts	0.28mm
	coil and contacts	1.0mm
Creepage	adjacent contacts	1.0mm
	open contacts	0.28mm
	coil and contacts	1.60mm

■ SAFETY STANDARDS

Type	Compliance	Contact rating
UL	UL 508	Flammability: UL 94-V0 (plastics) 0.5A, 125VAC (resistive) 1A, 30VDC (resistive)
	E63615	
CSA	C22.2 No. 14 LR 40304-58	0.3A, 110VDC (resistive) 2A, 30VDC (resistive)

■ CHARACTERISTIC DATA

- Standard type

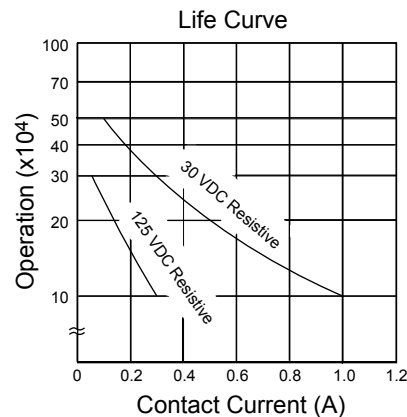
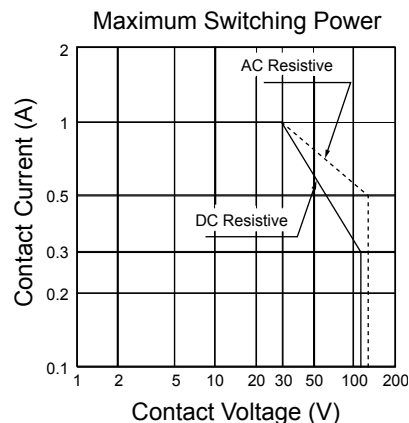
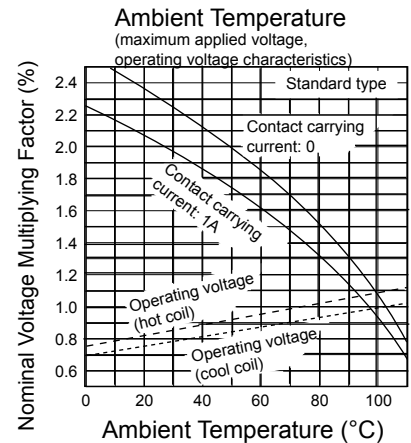
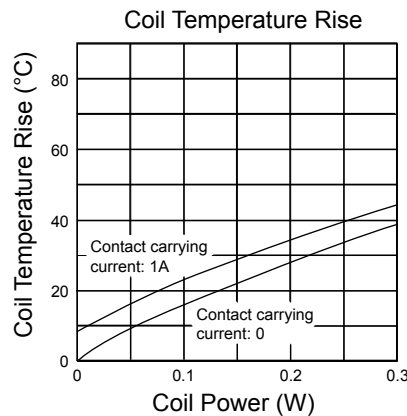
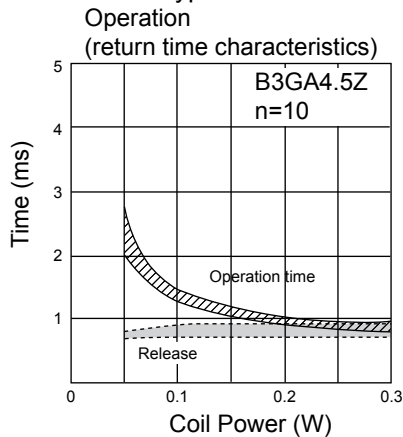

FTR-B3 Series

- Latching type (1 coil)
Operation
(return time characteristics)

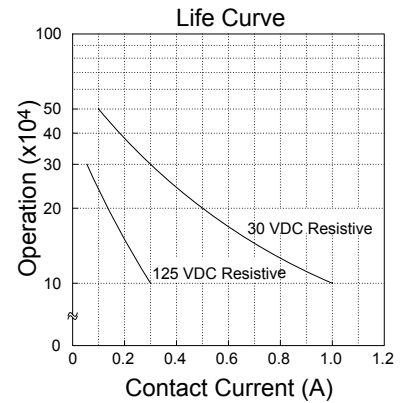
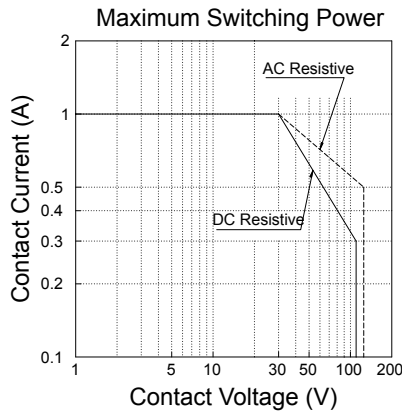
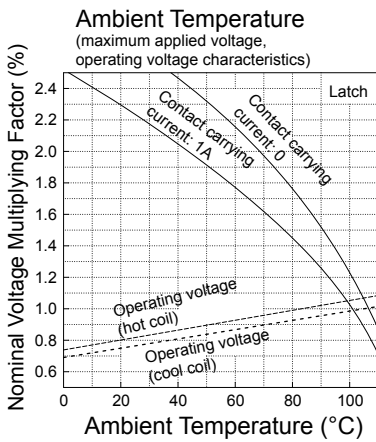
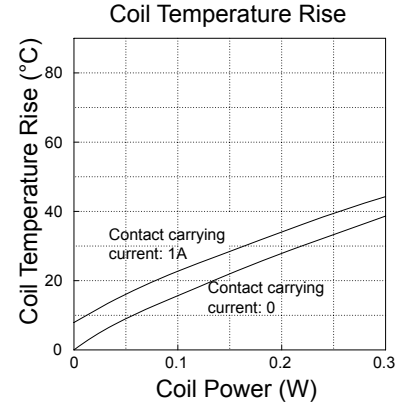
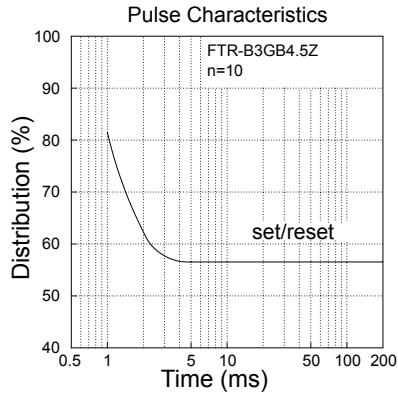
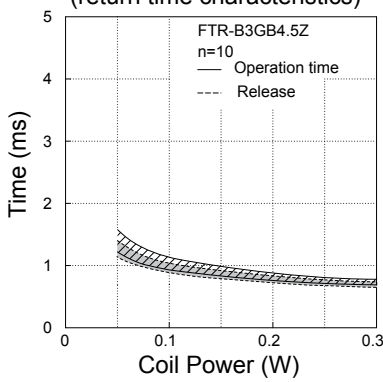

REFERENCE DATA

- Standard type

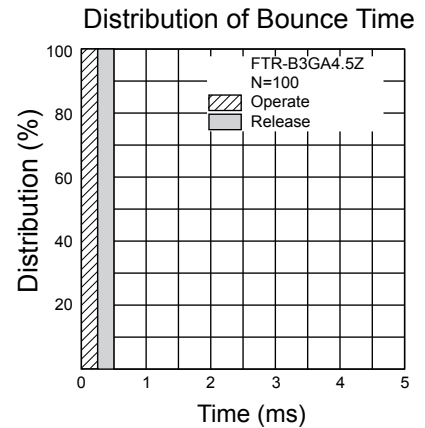
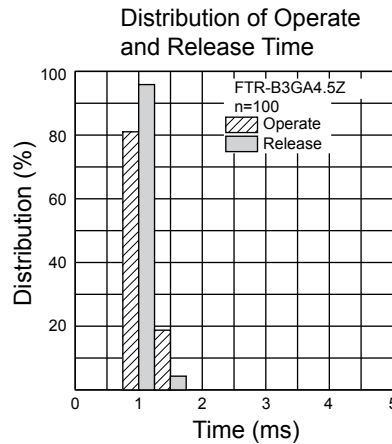
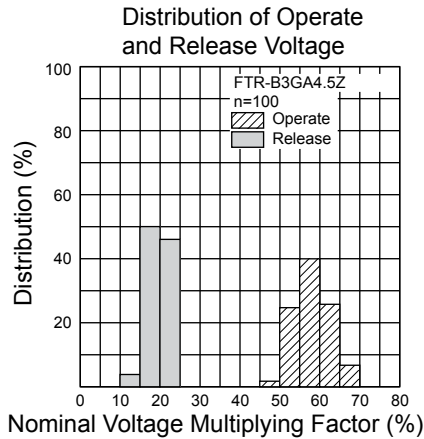

Distribution of Contact Resistance

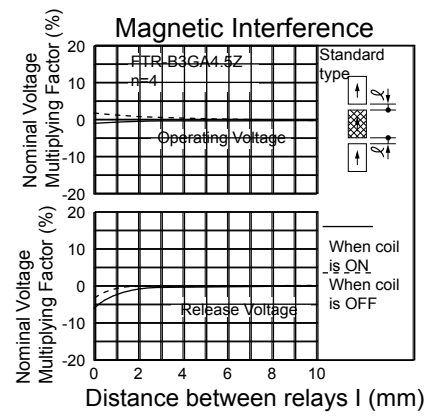
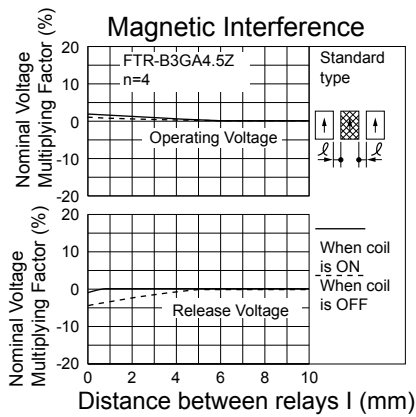
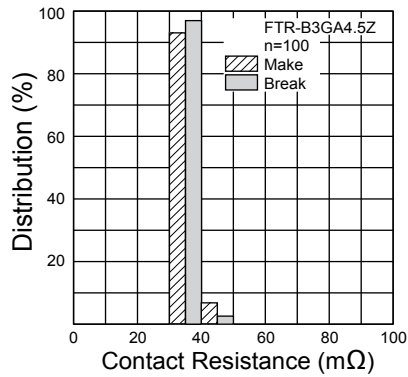

High Frequency Characteristics

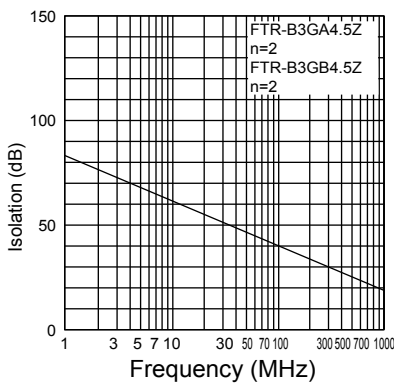

High Frequency Characteristics

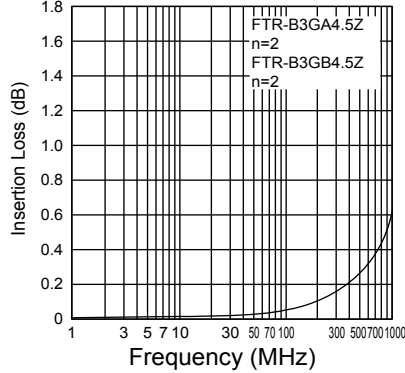

- Latching type (1 coil)

Distribution of Operate and Release Voltage

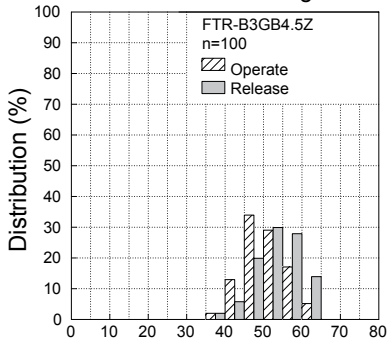

Distribution of Contact Resistance

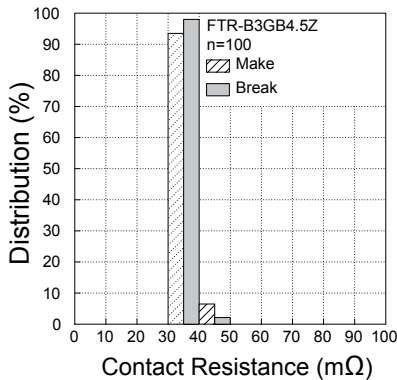

High Frequency Characteristics

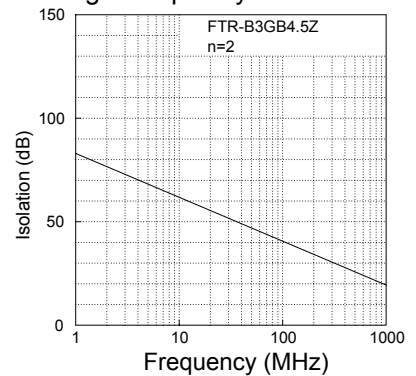

High Frequency Characteristics

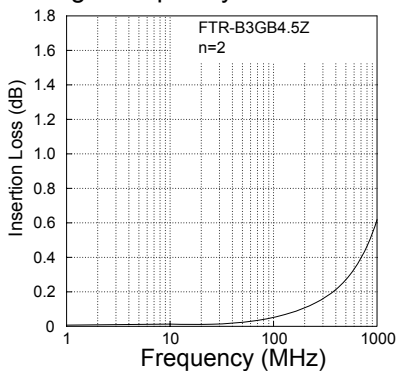

FTR-B3 Series

■ DIMENSIONS

FTR-B3C() () - Through hole type

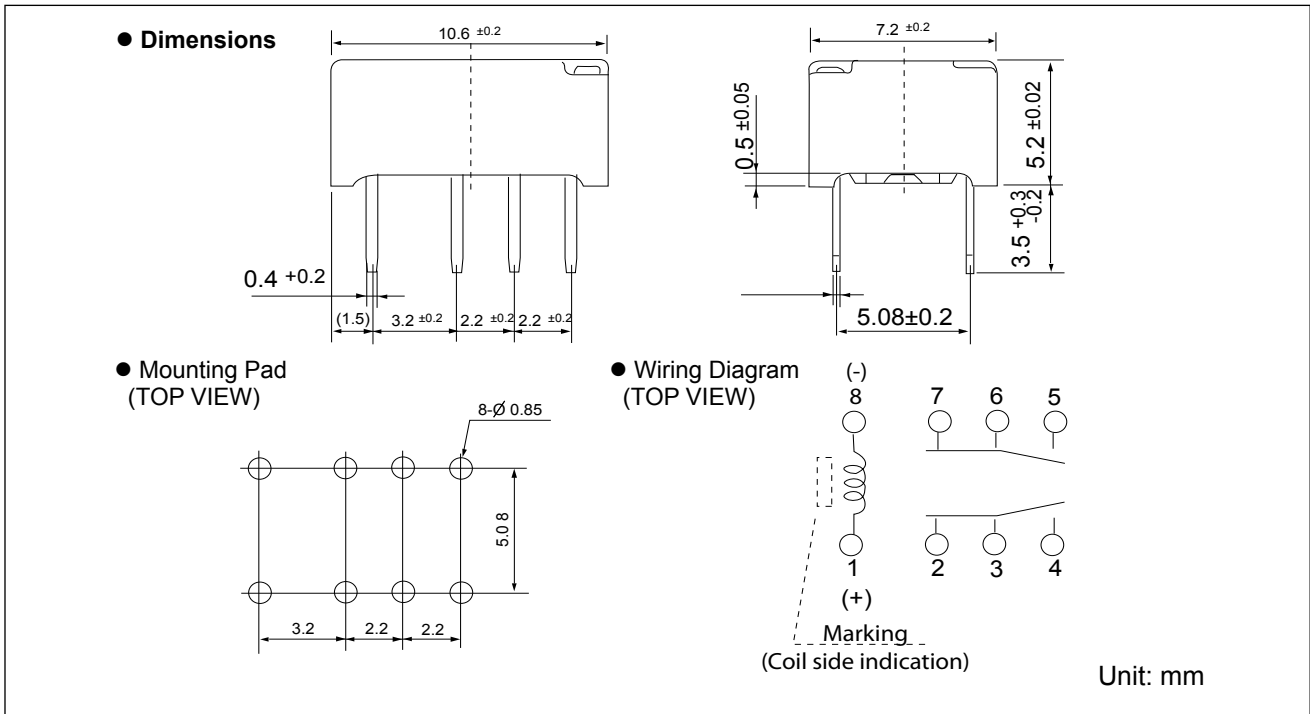

FTR-B3G() () - Surface mount type (standard)

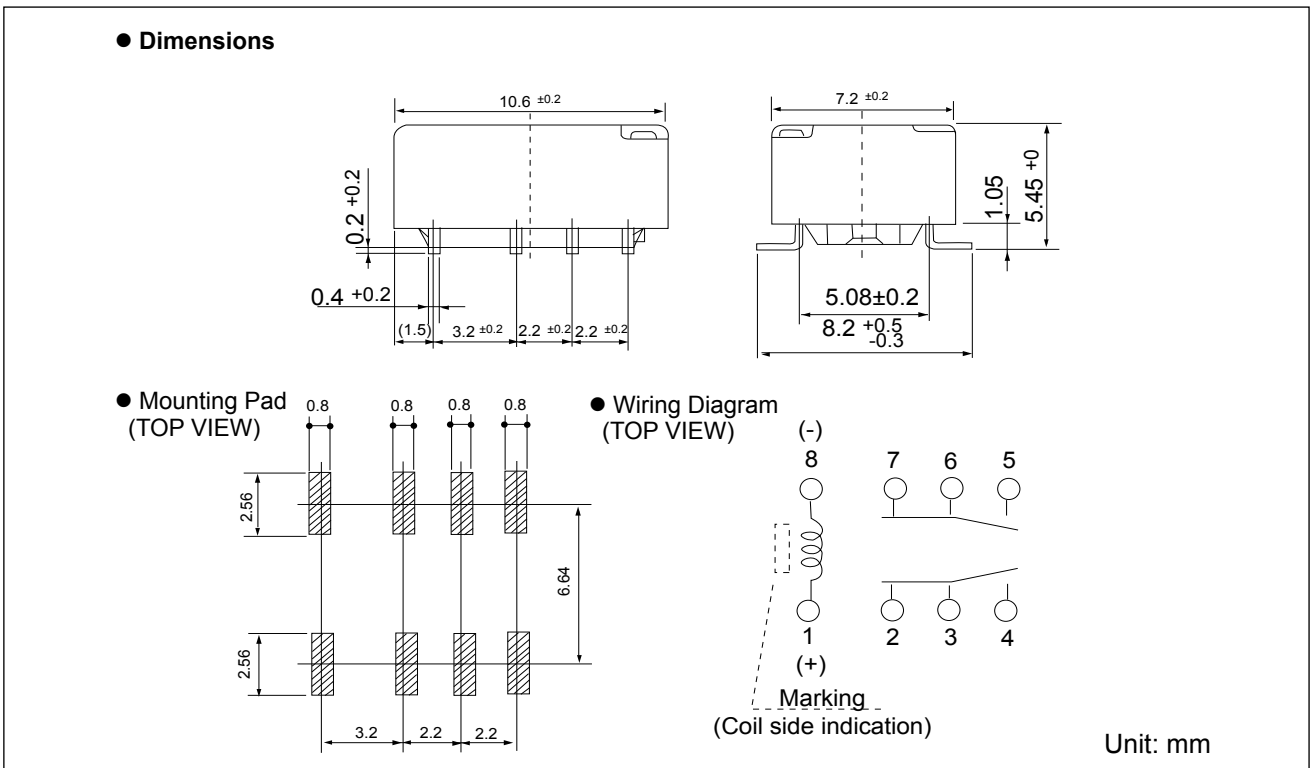

FTR-B3 Series

■ DIMENSIONS

FTR-B3S() () - Space saving type

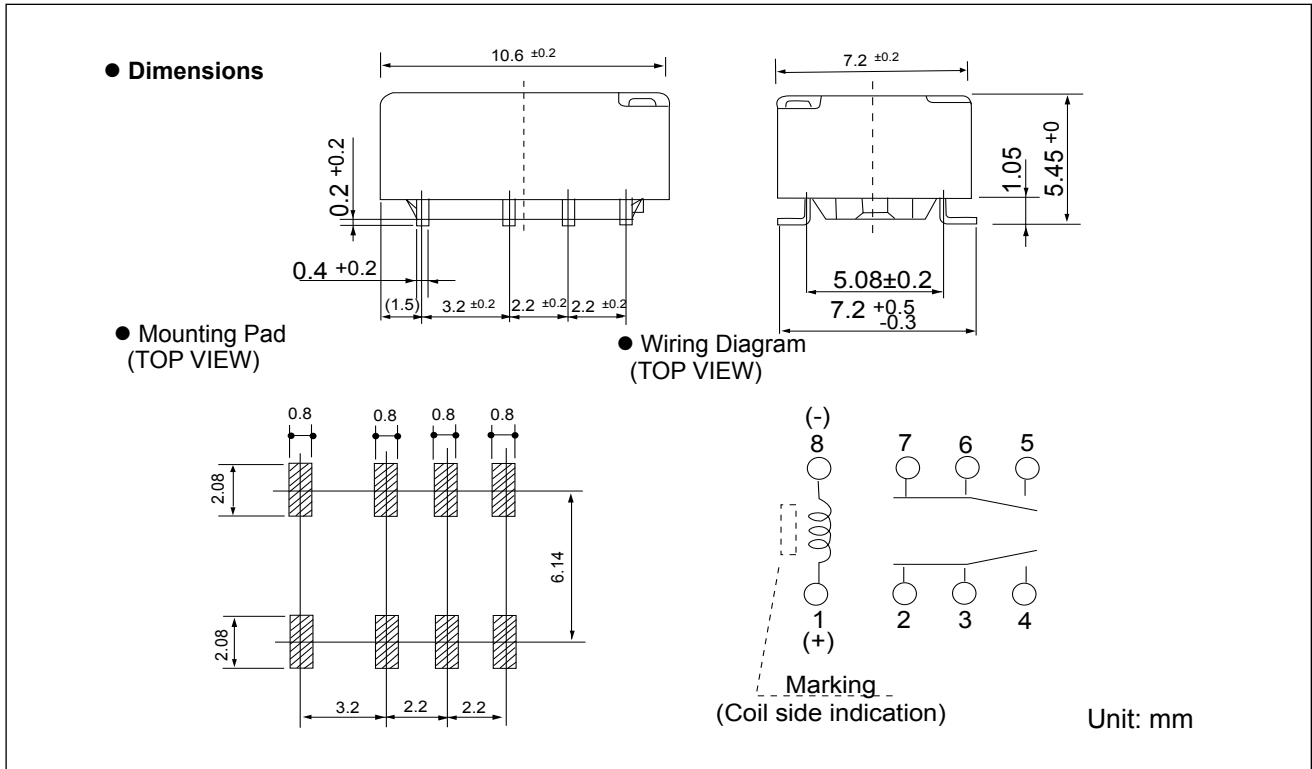

■ PACKAGING SPECIFICATIONS

● Packaging Method

- Packaging Standard: JIS C 0806
- Taping Type: TB 1612
- Reel Type: R16D
- Quantity of 1reel: 1000 pieces

● Packaging Orientation Code: B

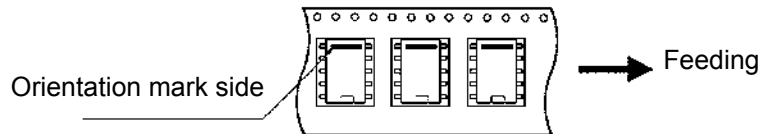

● (2) Dimensions

- Reel dimensions

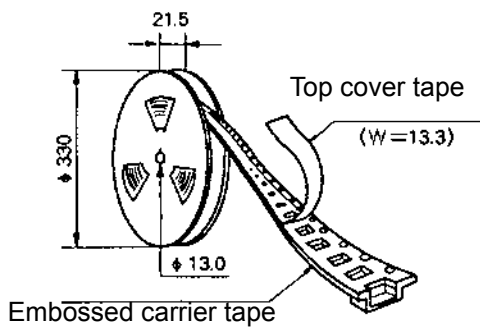

● Tape Dimensions

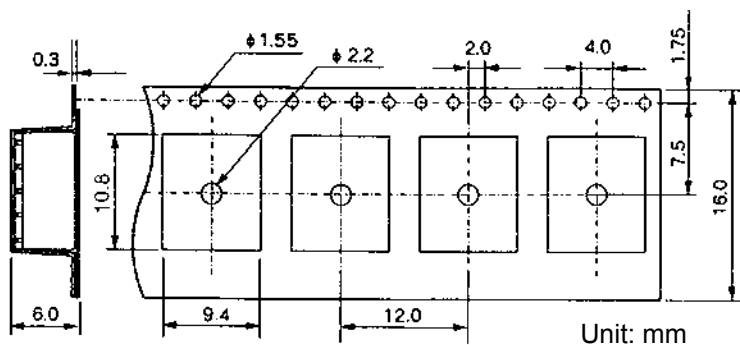

Note: Relays are sold in packs of 1000 pieces, please order 1000 pieces as one unit.

■ RECOMMENDED SOLDERING CONDITIONS FOR SMT (TEMPERATURE PROFILE)

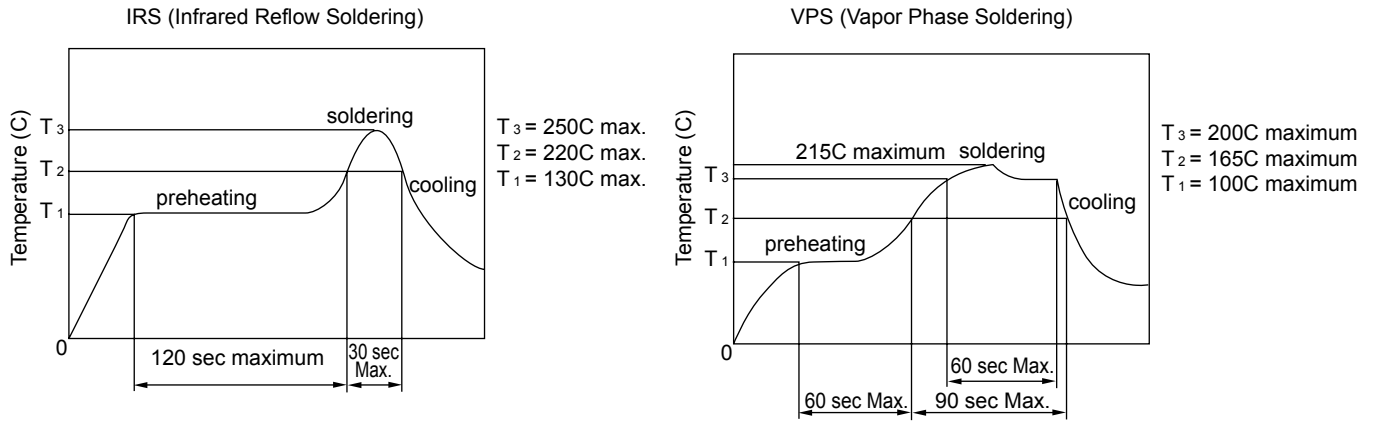

- Note:
1. Temperature profiles show the temperature of PC board surface.
 2. Please perform soldering test with your actual PC board before mass production, since the temperatures of PC board surfaces vary according to the size of PC board, status of parts mounting and heating method.

■ PRECAUTIONS

- For details on general precautions, refer to the section on technical descriptions.
- Since this is a polarized relay, follow the instructions of the internal wiring diagram for the ± connections of the coil.
- Note that the terminal layout and internal wiring of the surface mount relay are a top view

RoHS Compliance and Lead Free Relay Information

1. General Information

- If applicable, relays produced after the specific date code that is indicated on each data sheet are lead-free now. All of our signal and power relays are lead-free. Please refer to Lead-Free Status Info. (<http://www.fujitsu.com/us/downloads/MICRO/fcai/relays/lead-free-letter.pdf>)
 - Lead free solder plating currently used in relays is Sn-3.0Ag-0.5Cu. From February 2005 forward Sn-3.0Cu-Ni will be used for the FTR-B3 and FTR-B4 series relays.
 - All signal and power relays also comply with RoHS. Please refer to individual data sheets. Relays that are RoHS compliant do not contain the 5 hazardous materials that are restricted by RoHS directive (lead, mercury, chromium IV, PBB, PBDE, decaBDE and PFOS).
 - It has been verified that using lead-free relays in lead assembly process will not cause any problems (compatible).
 - "LF" is marked on each outer and inner carton. (No marking on individual relays).
 - To avoid lead containing relays (for lead-free sample, etc.) please consult with area sales office.
 - We will ship lead containing relays as long as the lead containing relay inventory exists, if allowed.
- Note: Cadmium was exempted from RoHS on October 21, 2005. (Amendment to Directive 2002/95/EC)

2. Recommended Lead Free Solder Profile

- Recommended solder paste Sn-3.0Ag-0.5Cu or Sn-3.0 Cu-Ni (only FTR-B3 and FTR-B4 from February 2005).

Reflow Solder condition

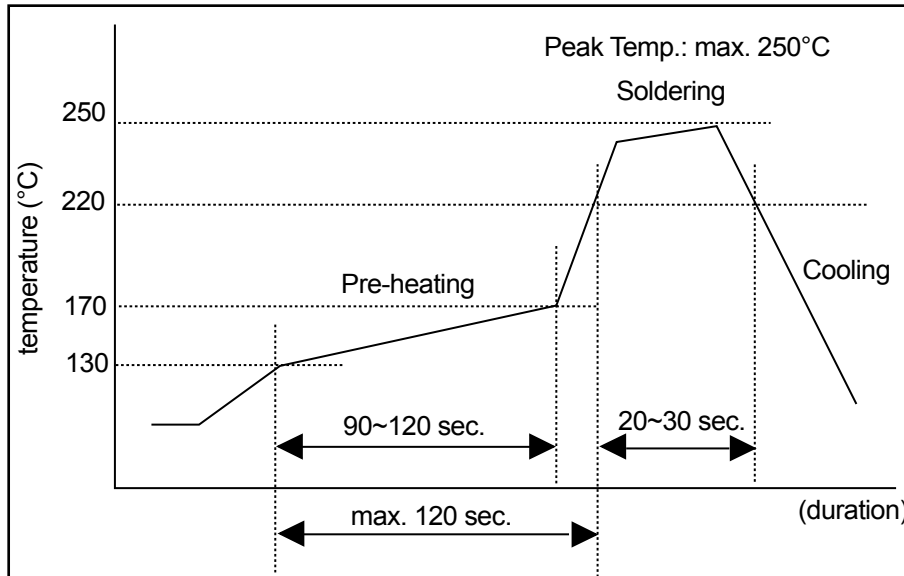

Flow Solder condition:	
Pre-heating:	maximum 120°C
Soldering:	dip within 5 sec. at 260°C solder bath

Solder by Soldering Iron:	
Soldering Iron	
Temperature:	maximum 360°C
Duration:	maximum 3 sec.

We highly recommend that you confirm your actual solder conditions

3. Moisture Sensitivity

- Moisture Sensitivity Level is not applicable to electromechanical relays.

4. Tin Whisker

- SnAgCu and SnCuNi solder are known as low risk of tin whisker. No considerable whisker length was found by our in-house test.

Fujitsu Components International Headquarter Offices

Japan

Fujitsu Component Limited
Gotanda-Chuo Building
3-5, Higashigotanda 2-chome, Shinagawa-ku
Tokyo 141, Japan
Tel: (81-3) 5449-7010
Fax: (81-3) 5449-2626
Email: promothq@ft.ed.fujitsu.com
Web: www.fcl.fujitsu.com

North and South America

Fujitsu Components America, Inc.
250 E. Caribbean Drive
Sunnyvale, CA 94089 U.S.A.
Tel: (1-408) 745-4900
Fax: (1-408) 745-4970
Email: components@us.fujitsu.com
Web: <http://us.fujitsu.com/relays/>

Europe

Fujitsu Components Europe B.V.
Diamantlaan 25
2132 WV Hoofddorp
Netherlands
Tel: (31-23) 5560910
Fax: (31-23) 5560950
Email: info@fceu.fujitsu.com
Web: emea.fujitsu.com/components/

Asia Pacific

Fujitsu Components Asia Ltd.
102E Pasir Panjang Road
#01-01 Citilink Warehouse Complex
Singapore 118529
Tel: (65) 6375-8560
Fax: (65) 6273-3021
Email: fcal@fcal.fujitsu.com
Web: <http://www.fujitsu.com/sg/services/micro/components/>

©2009 Fujitsu Components America, Inc. All rights reserved. All trademarks or registered trademarks are the property of their respective owners.

Fujitsu Components America or its affiliates do not warrant that the content of datasheet is error free. In a continuing effort to improve our products Fujitsu Components America, Inc. or its affiliates reserve the right to change specifications/datasheets without prior notice.
Rev. September 11th, 2009.

X-ON Electronics

Largest Supplier of Electrical and Electronic Components

Click to view similar products for [Low Signal Relays - PCB category](#):

Click to view products by [Fujitsu manufacturer](#):

Other Similar products are found below :

[LZN4-US-DC12](#) [LZNQ4-US-DC24](#) [LZNQ4-US-DC48](#) [6-1617347-5](#) [6-1617353-3](#) [6-1617529-6](#) [M39016/27-030M](#) [67RPCX-3](#) [D3493L](#) [7-1393813-3](#) [MF-11AM-24](#) [MF1201N12](#) [MF-17A-24](#) [FBR244D024/02CS](#) [80.010.4522.1](#) [8-1393813-6](#) [8-1617347-2](#) [FL-4036](#) [FLH-11D-6](#) [831A7](#) [MMS124](#) [FW1201S39](#) [FW1210S02](#) [FW1521S01](#) [FW5A11116S01](#) [FW5A11145G01](#) [9-1617582-5](#) [G6AK-2-H-DC5](#) [G6E-184P-ST-US-DC48](#) [G6G234CDC24](#) [A07A939BZ1-0388](#) [PZ-2A2420](#) [HB1-DC9V](#) [R10-14A10-240](#) [R10-14D10-12](#) [R10-5A10-120F](#) [R10-E2468-1](#) [R10-E4Z2-V700](#) [R10-T1L2N-115V](#) [R40-E1Z4-V50](#) [R40-E3Z4-V200](#) [R50-E2Y2-24](#) [HFW11130K01](#) [HFW1131B00](#) [HFW1201W200](#) [RA30511121](#) [RA-5W-K](#) [RB06H2C12](#) [REL-MR- 60DC/21AU](#) [RG2ET-L-12V](#)