

ULTRA MINIATURE RELAY

2 POLES - 2 A (Low Profile Signal Relay)

FTR-B3 Series

■ FEATURES

- DPDT 2C
- Ultra miniature low profile relay with high heat resistant material
- Height: 5.45mm, Weight: 0.85g, Mounting space: 87mm²
- Adopted superior contact spring for high frequency characteristic
- Comply with Telcordia / FCC part 68
 - Isolation distance: min. 1.6mm
 - Dielectric strength between coil and contact: 1500VAC
 - Surge strength: 2500V
- Low power: Non-latching: 140mW (230mW at 24V)
Latching: 100mW (120mW at 24V)
- High reliable bifurcated gold overlay silver contact
- UL, CSA recognized. Conforms to BSI, IEC60950-1
- RoHS compliant. Please see page 9 for more information
- Plastic sealed

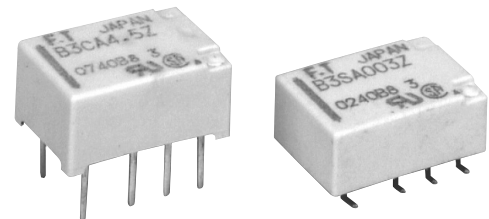

■ PARTNUMBER INFORMATION

[Example] FTR-B3 G B 012 Z - B10
 (a) (b) (c) (d) (e) (f)

(a)	Relay type	FTR-B3	: FTR-B3-Series
(b)	Terminal type	C G S	: Through hole : Surface mount : Surface mount, space saving
(c)	Coil type	A B	: Standard type : Latching type (1 coil)
(d)	Coil rated voltage	012	: 1.5.....24 VDC Coil rating table at page 3
(e)	Contact material	Z P	: Gold overlay silver nickel : Gold overlay silver palladium
(f)	Packaging	Nil B10	: Tube packaging : Tape&Peel packaging (only for surface mount type)

Remarks: Actual marking on relay would not carry code FTR and be as below:
 Ordering code: FTR-B3GB012Z-B10 Actual marking: B3GB012Z

FTR-B3 SERIES

■ SPECIFICATION

Item			Standard type	Latching type
			FTR-B3 () A	FTR-B3 () B
Contact Data	Configuration		2 form C	
	Construction		Bifurcated contacts	
	Material		Z: Gold overlay silver nickel / P: Gold overlay silver palladium	
	Resistance (initial)		Max. 75 mΩ at 1 A, 6 VDC	
	Contact rating (resistive)		30VDC, 1A / 125VAC, 0.3A	
	Max. carrying current		2A	
	Max. switching voltage		250 VAC / 220VDC	
	Max. switching power		62.5VA / 30W	
	Min. switching load *		0.01mA, 10mVDC	
Life	Mechanical		Min. 50 x 10 ⁶ operations	Min. 20 x 10 ⁶ operations
	Electrical (rated load)		Min. 100 x 10 ³ operations at 1A 30VDC Min. 100 x 10 ³ operations at 0.3A 125VAC	
Coil Data	Rated power (at 20 °C)		140mW - 230mW	100mW - 120mW
	Applied pulse width		-	Min. 10ms
	Operate power (at 20 °C)		80mW - 130mW	57mW - 68mW
	Operating temperature range		-40 °C to +85 °C (no frost)	
	Storage temperature / humidity		-40 °C to +85 °C / 5% to 85% RH (no frost)	
Timing Data	Operate (at nominal voltage, no bounce)		Max. 3 ms	Max. 3 ms (set)
	Release (at nominal voltage, no bounce)		Max. 3 ms	Max. 3 ms (reset)
Insulation	Resistance (initial)		Min. 1,000MΩ at 500VDC	
	Dielectric strength	Open contacts	1,000VAC (50/60Hz) 1min	
		Adjacent contacts	1,000VAC (50/60Hz) 1min.	
		Contacts to coil	1,500VAC (50/60Hz) 1min	
	Surge strength	Contacts to coil	2,500V, 2 x 10μs standard wave	
	Clearance	Open contacts	0.28 mm	
		Adjacent contacts	1.0 mm	
		Contacts to coil	1.0 mm	
	Creepage	Open contacts	0.28 mm	
Adjacent contacts		1.0 mm		
Contacts to coil		1.60 mm		
Other	Vibration resistance	Misoperation	10 to 55 to 10Hz single amplitude 1.65mm	
		Endurance	10 to 55 to 10Hz single amplitude 2.5mm	
	Shock	Misoperation	750m/s ² (11 ±1ms)	
		Endurance	1,000m/s ² (6 ±1ms)	
	Weight	Approximately 0.85 g		
	Sealing	RT III (plastic sealed)		

* Minimum switching loads mentioned above are reference values. Please perform the confirmation test with actual load before production since reference values may vary according to switching frequencies, environmental conditions and expected reliability levels.

FTR-B3 SERIES

■ COIL RATING

Standard type

Coil Code	Rated Coil Voltage (VDC)	Coil Resistance +/- 10% (Ohm)	Must Operate Voltage (VDC) *	Must Release Voltage (VDC) *	Rated Power (mW)
1.5	1.5	16.1	1.13	0.15	140
003	3	64.3	2.25	0.3	
4.5	4.5	145	3.38	0.45	
006	6	257	4.5	0.6	
009	9	579	6.75	0.9	
012	12	1,028	9.0	1.2	230
024	24	2,504	18.0	2.4	

Latching type (1 coil)

Coil Code	Rated Coil Voltage (VDC)	Coil Resistance +/- 10% (Ohm)	Set Voltage (VDC) *	Reset Voltage (VDC) *	Set/Reset current (mA)	Rated Power (mW)
1.5	1.5	22.5	+1.13	-1.13	50	100
003	3	90	+2.25	-2.25	25	
4.5	4.5	203	+3.38	-3.38	17	
006	6	360	+4.5	-4.5	13	
009	9	810	+6.75	-6.75	8	
012	12	1,440	+9.0	-9.0	6	120
024	24	4,800	+18.0	-18.0	4	

Note: All values in the table are valid for 20°C and zero contact current.

* Specified operate values are valid for pulse wave voltage.

■ SAFETY STANDARDS

Type	Compliance	Contact rating
UL	UL 508	Flammability: UL 94-V0 (plastics)
	E 63615	0.5A, 125VAC (resistive) 0.3A, 110VDC (General use)
CSA	C22.2 No. 14 LR 40304-58	2A, 30VDC (General use)

Comply with Telcordia specifications and FCC part 68 and meet BSI, IEC60950-1:
Marking only for UL, CSA

CHARACTERISTIC DATA (Reference)

- Standard type

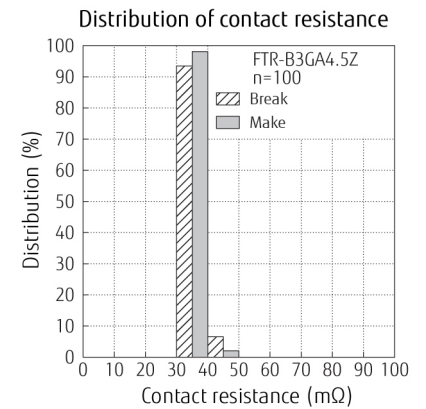
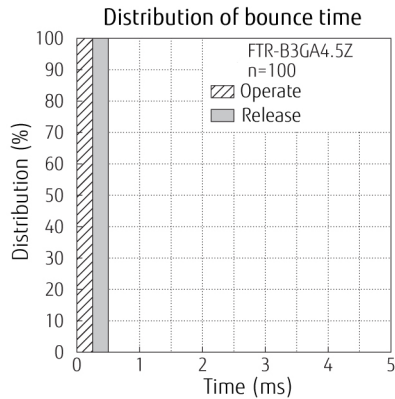
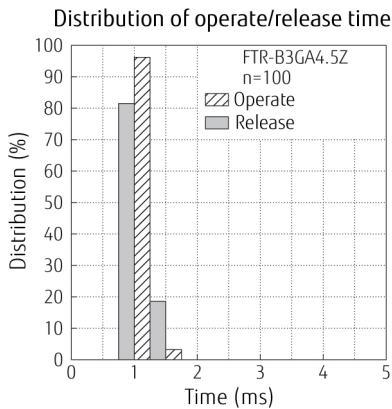
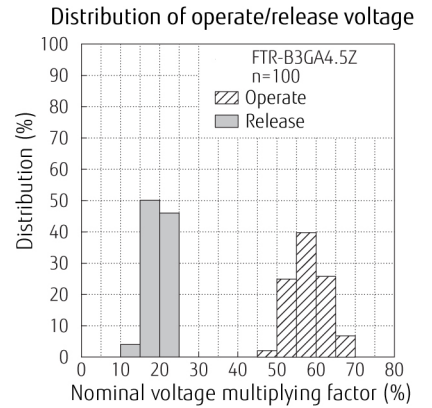
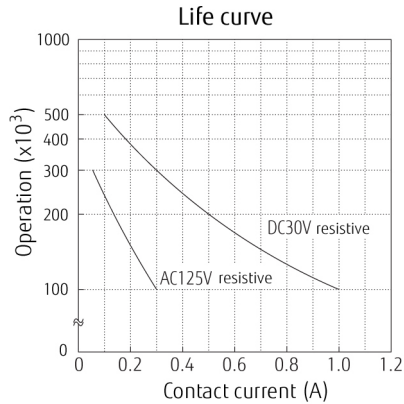
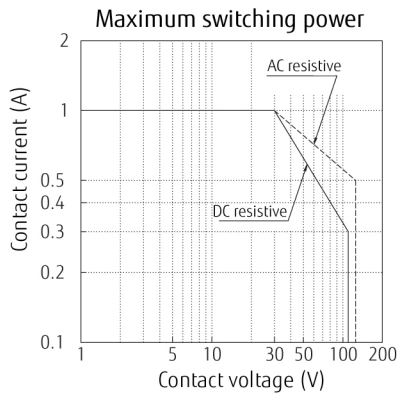
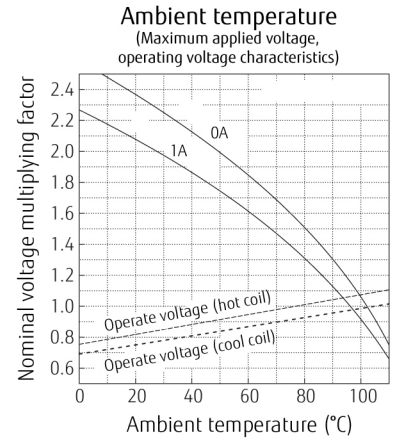
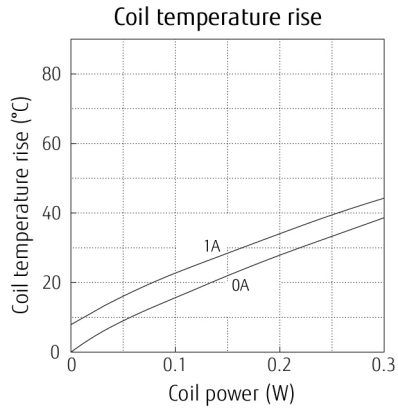
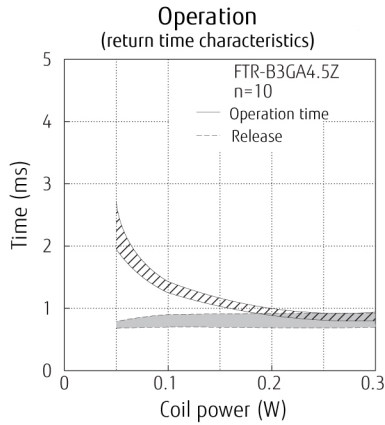

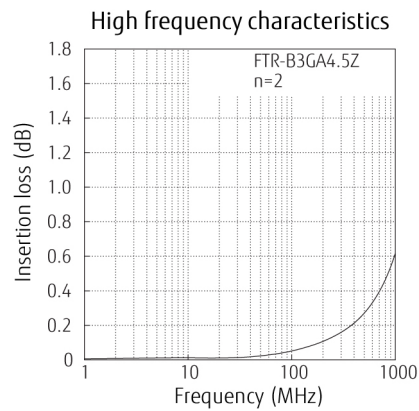
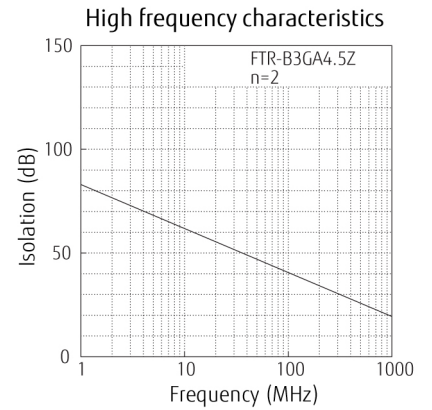
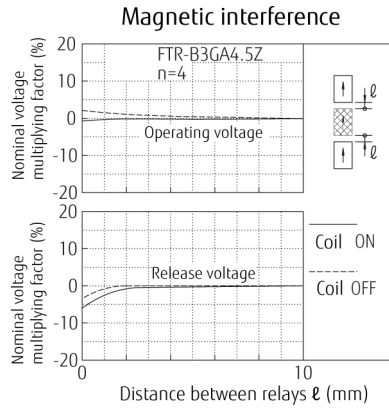
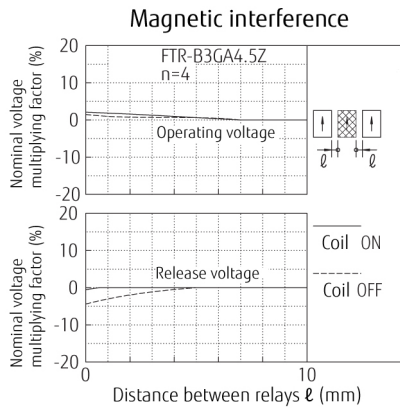

- Latching type

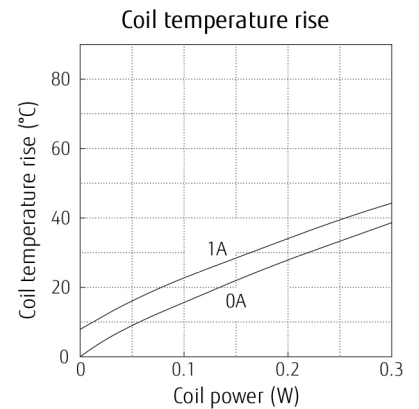
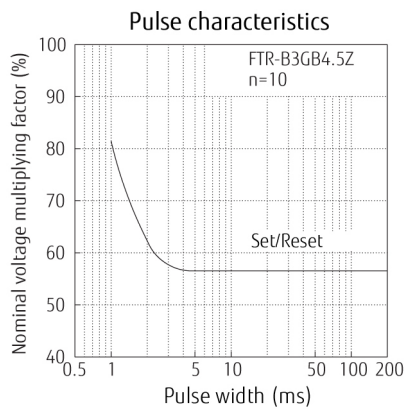
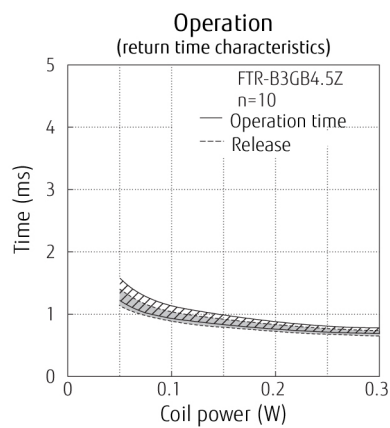

FTR-B3 SERIES

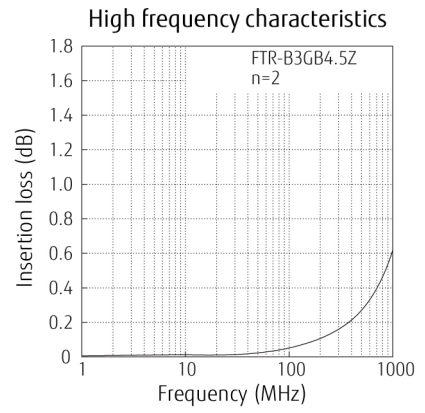
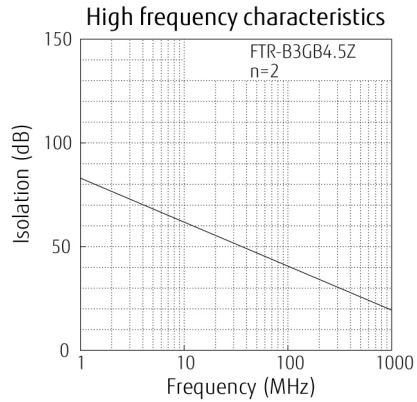
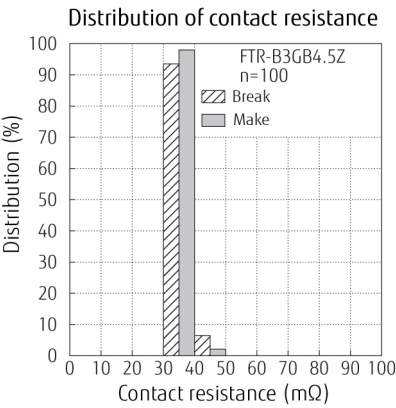
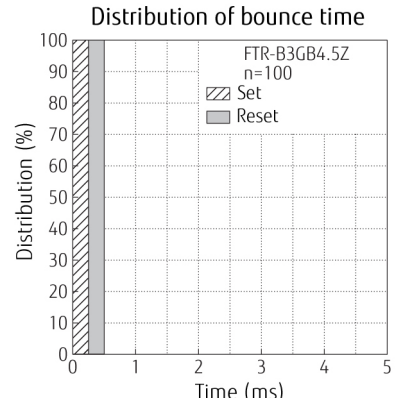
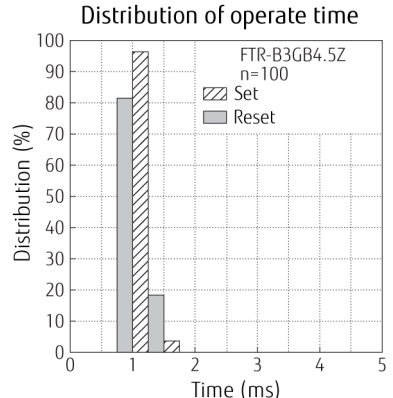
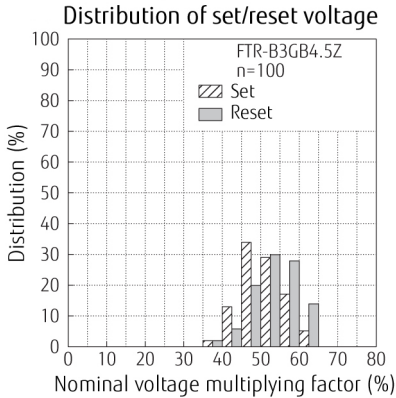
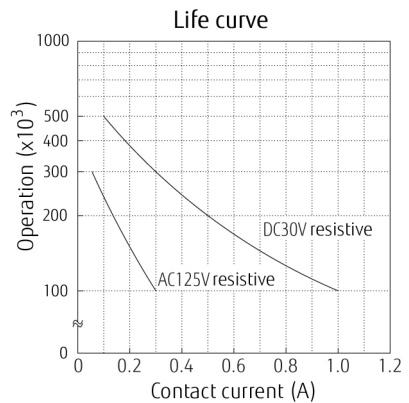
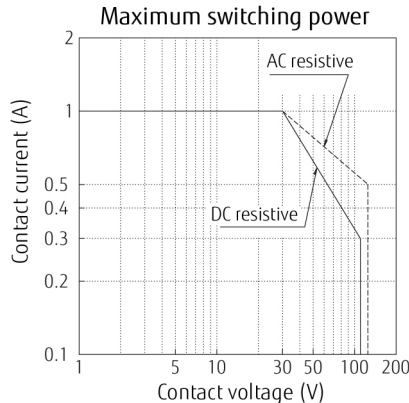
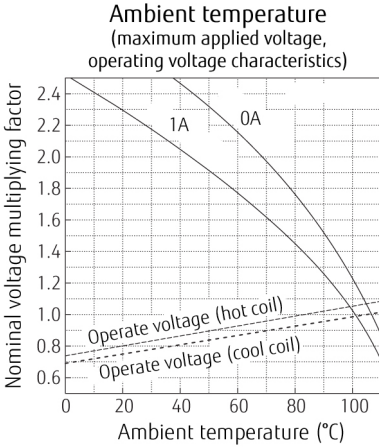

FTR-B3 SERIES

■ DIMENSIONS

FTR-B3C - Through hole type

● Dimensions

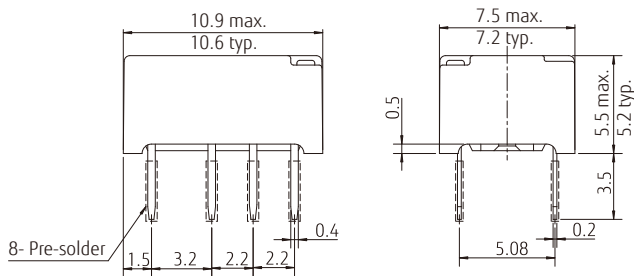

● Schematics * (BOTTOM VIEW)

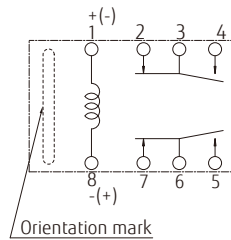

● PC board mounting hole layout

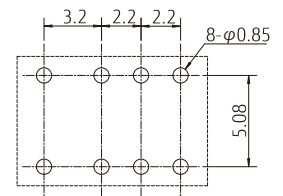

FTR-B3G - Surface mount type

● Dimensions

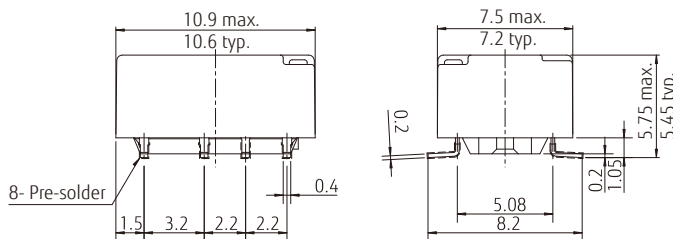

● Schematics * (TOP VIEW)

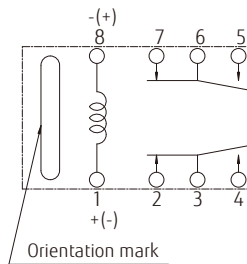

● PC board mounting pad layout

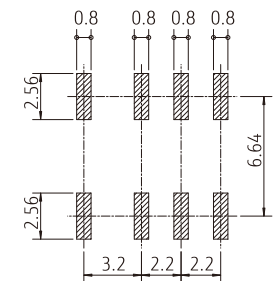

FTR-B3S - Space saving type

● Dimensions

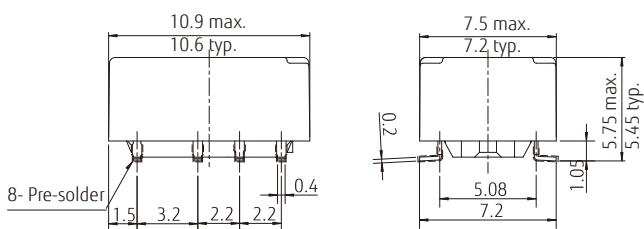

● Schematics * (TOP VIEW)

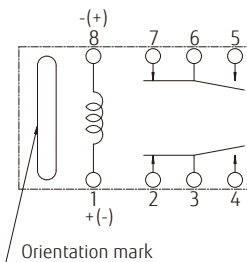

● PC board mounting pad layout (TOP VIEW)

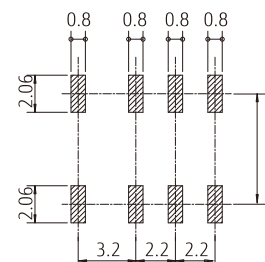

* Contacts indicates reset state for latching relays (FTR-B3CB, FTR-B3GB and FTR-B3SB versions) and non-operate state for standard relays (FTR-B3CA, FTR-B3GA and FTR-B3SA versions).

* +/- : Apply set voltage for latching relays, operate voltage for standard relays.

(+)/(-): Apply reset voltage for latching relays.

Note: Tolerance for PC board mounting hole/pad layout: +/-0.1.

Note: Dimensions of the terminals do not include thickness of pre-solder.

Unit: mm
(): Reference

■ COIL POLARITY LATCHING TYPE

Coil terminal	1	8
Set	+	-
Reset	-	+

■ RECOMMENDED SOLDERING CONDITIONS FOR SMT (SEE PAGE 9) (TEMPERATURE PROFILE)

Notes:

1. Temperature profiles on page 9 show the temperature of PC board surface.
2. Please perform soldering test with your actual PC board before mass production, since the temperatures of PC board surfaces vary according to the size of PC board, status of parts mounting and heating method.

■ PRECAUTIONS

- For details on general precautions, refer to the section on technical descriptions.
- Since this is a polarized relay, follow the instructions of the internal wiring diagram for the \pm connections of the coil.
- Note that the terminal layout and internal wiring of the surface mount relay are a top view.
- Characteristic data is not guaranteed value but measured values of samples from production line.

■ PACKAGING SPECIFICATIONS

● Packaging method

- Packaging standard: JIS C 0806
- Taping type: TB 1612
- Reel type: R16D
- Quantity of 1 reel: 1000 pieces

● Packaging orientation code: B

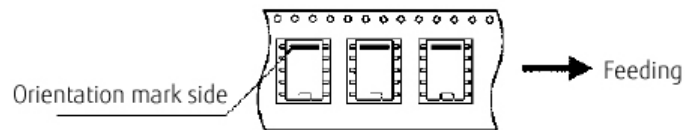

● Reel dimensions

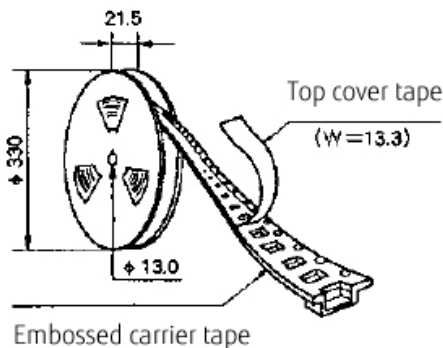

● Tape dimensions

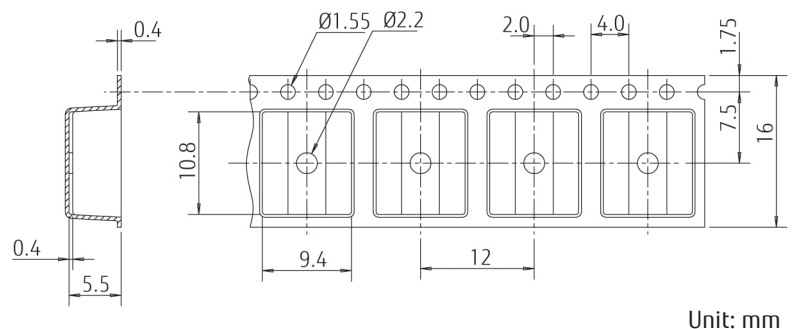

Unit: mm

Note:

Relays are sold in 1000 pieces per box. Minimum order quantity is 1000 pieces for tube and tape & reel packing.

General information

1. ROHS COMPLIANCE

- All relays produced by Fujitsu Components are compliant with RoHS directive 2011/65/EU including amendments.
- Use of cadmium in electrical contacts is exempted as per Annex III of the RoHS directive 2011/65/EU. Please consider expiry date of exemption. Relays with cadmium containing contacts are not to be used for new designs.
- All relays are lead-free. Please refer to Lead-Free Status Info for older date codes at: <http://www.fujitsu.com/downloads/MICRO/fcai/relays/lead-free-letter.pdf>

2. Recommended Lead Free Solder Condition

- Lead free solder plating on relay terminals is Sn-3.0Ag-0.5Cu, unless otherwise specified. This material has been verified to be compatible with PbSn assembly process.
- Recommended solder Sn-3.0Ag-0.5Cu.

Flow Solder Condition:

Pre-heating: maximum 120°C within 90 sec.
 Soldering: dip within 5 sec. at 255°C ± 5°C solder bath
 Relay must be cooled by air immediately after soldering

Solder by Soldering Iron:

Soldering Iron 30-60W
 Temperature: maximum 340-360°C
 Duration: maximum 3 sec.

Reflow Solder Condition for SMT

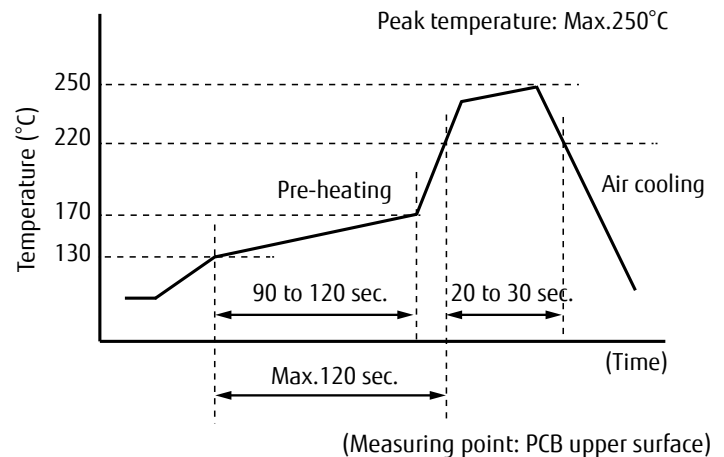

We highly recommend that you confirm your actual solder conditions

3. Moisture Sensitivity

- SMT versions of FTR-B3 relays in Tape & Reel package will be shipped in Moisture Barrier Bag (MBB).
- Moisture Sensitivity Level (MSL) of FTR-B3 relay is indicated on the packing caution label.
- Relays must be stored in the unopened MBB at storage conditions <40C/90%RH for a maximum 1 year
- SMT versions of FTR-B3 relays in tube packing will not be shipped in MBB. Therefore, these relays shall be dried by baking before reflow soldering process according to IPC/JEDEC J-STD-033.

4. Tin Whiskers

- Dipped SnAgCu solder is known as presenting a low risk to tin whisker development. No considerable length whisker was found by our in house test.

Cautions

- All values mentioned in this datasheet are provided under ideal conditions. Please perform the confirmation test before actual use.
- Reflow soldering is prohibited for through hole relays.
- Do not use relays in the atmosphere with sulfide gas, chloride gas or nitric oxide. Contact resistance may increase.
- Do not use silicon or silicon-containing product or materials near relays. It may cause contact failure.

Cautions for latching relays

- Latching relays are shipped in the state set, but state may change due to shock during transportation or mounting. Before using the relays, it is advisable to bring the relays in necessary state (set or reset) and program a circuit sequence. Otherwise, it will or will not operate simultaneously with power activation.
- Please connect relay coils according to specified polarity.
- Do not apply voltage to both set coil and reset coil at a time.

Fujitsu Components International Headquarter Offices

<p>Japan FUJITSU COMPONENT LIMITED Shinagawa Seaside Park Tower 19F, 12-4, Higashi-shinagawa 4-chome, Shinagawa-ku, Tokyo, 140-0002, Japan Tel: (81-3) 3450-1682 Fax: (81-3) 3474-2385 Email: fcl-contact@cs.jp.fujitsu.com Web: www.fujitsu.com/jp/fcl/</p>	<p>Asia Pacific FUJITSU COMPONENTS ASIA, LTD. 102E Pasir Panjang Road #01-01 Citilink Warehouse Complex Singapore 118529 Tel: (65) 6375-8560 Fax: (65) 6273-3021 Email: fcal@sg.fujitsu.com Web: www.fujitsu.com/sg/products/devices/components</p>	<p>Korea FUJITSU COMPONENTS KOREA LIMITED Alpha Tower #403, 645 Sampyeong-dong, Bundang-gu, Seongnam-si, Gyeonggi-do, 13524 Korea Tel: (82) 31-708-7108 Fax: (82) 31-709-7108 Email: fcal@sg.fujitsu.com www.fujitsu.com/sg/products/devices/components/</p>
<p>North and South America FUJITSU COMPONENTS AMERICA, INC 2290 North First Street, Suite 212 San Jose, CA 95131, USA Tel: (1-408) 745-4900 Fax: (1-408) 745-4970 Email: components@us.fujitsu.com Web: us.fujitsu.com/components</p>	<p>China FUJITSU ELECTRONIC COMPONENTS (SHANGHAI) CO., LTD. Unit 4306, InterContinental Center 100 Yu Tong Road, Shanghai 200070, China Tel: (86-21) 3253 0998 Fax: (86-21) 3253 0997 Email: fcsh@cn.fujitsu.com Web: www.fujitsu.com/cn/products/devices/components/</p>	
<p>Europe FUJITSU COMPONENTS EUROPE B.V. Diamantlaan 25 2132 WV Hoofddorp Netherlands Tel: (31-23) 5560910 Fax: (31-23) 5560950 Email: info@fceu.fujitsu.com Web: www.fujitsu.com/uk/components</p>	<p>Hong Kong FUJITSU COMPONENTS HONG KONG CO., LTD Unit 506, Inter-Continental Plaza No.94 Granville Road, Tsim Sha Tsui, Kowloon, Hong Kong Tel: (852) 2881-8495 Tex: (852) 2894-9512 Email: fcal@sg.fujitsu.com Web: www.fujitsu.com/sg/products/devices/components/</p>	

© 2020 Fujitsu Components Europe B.V. All rights reserved. All trademarks or registered trademarks are the property of their respective owners.

The contents, data and information in this datasheet are provided by Fujitsu Component Ltd. as a service only to its user and only for general information purposes. The use of the contents, data and information provided in this datasheet is at the users' own risk.

Fujitsu has assembled this datasheet with care and will endeavor to keep the contents, data and information correct, accurate, comprehensive, complete and up to date.

Fujitsu Components Europe B.V. and affiliated companies do however not accept any responsibility or liability on their behalf, nor on behalf of its employees, for any loss or damage, direct, indirect or consequential, with respect to this datasheet, its contents, data, and information and related graphics and the correctness, reliability, accuracy, comprehensiveness, usefulness, availability and completeness thereof.

Nor do Fujitsu Components Europe B.V. and affiliated companies accept on their behalf, nor on behalf of its employees, any responsibility or liability with respect to these datasheets, its contents, data, information and related graphics and the correctness, reliability, accuracy, comprehensiveness, usefulness, availability and completeness thereof. Rev. June 8, 2020

X-ON Electronics

Largest Supplier of Electrical and Electronic Components

Click to view similar products for [High Frequency / RF Relays](#) category:

Click to view products by [Fujitsu](#) manufacturer:

Other Similar products are found below :

[134M4-26](#) [134YZM4-12](#) [136CM9-5](#) [ER136CZM9-5B](#) [ER412DYM-12B](#) [ARA200A4HM01](#) [3SBH1020A2](#) [400-192-10](#) [412TM-18](#)
[ARN12A12](#) [422DM-26](#) [411T-12](#) [LB363-100-5](#) [D3210](#) [ARN10A12](#) [ER116C-26A](#) [ER114ZM4-5A/SQ](#) [ER114ZM4-12A/SQ](#) [ER412-26B/Q](#)
[ER134DYZ-12A](#) [36 AT5](#) [25-200ZA](#) [36 T5](#) [48-000ZA](#) [27 T5](#) [24-200ZA](#) [27 T5](#) [26-200ZA](#) [27 T5](#) [28-200ZA](#) [ER411DM4-12A/SQ](#)
[732-5/Q](#) [R591362640](#) [R591723400](#) [R595867120](#) [HF3 02](#) [R594873417](#) [R595863115](#) [IM43TS](#) [IMB03CTS](#) [732TN-26](#) [1-1462038-1](#)
[IMB06CTS](#) [1462051-5](#) [1462050-1](#) [1462050-2](#) [G6K-2F-RF-S-DC5](#) [ARE10A4H](#) [ARE1024](#) [ARS1012](#) [ARJ22A12](#) [ARS104H](#) [FTR-](#)
[B3GA4.5Z-B10](#) [FTR-B3CA024Z](#) [1-1462039-7](#)