

POWER RELAY

1 POLE - 10A High sensitivity

FTR-K1 Series

■ FEATURES

- Low profile (height: 15.7mm)
 - High insulation
Insulation distance (between coil and contacts): 10mm min.
Dielectric strength: 5KV
Surge strength: 10KV
 - Low coil power (400mW)
 - Cadmium free contacts
 - Safety standards
UL, CSA, VDE approved
UL, CSA TV-5 rating approved (1 form A type)
 - UL F class wire insulation
 - Flux proof, RTII
 - RoHS compliant
- Please see page 6 for more information



■ PARTNUMBER INFORMATION

[Example] FTR-K1 A L 012 W - LA - BG
 (a) (b) (c) (d) (e) (f) (g)

(a)	Relay type	FTR-K1	: FTR-K1-Series
(b)	Contact configuration	A C	: 1 form A (SPST-NO) : 1 form C (SPDT)
(c)	Coil type / enclosure	L	: High sensitivity (250mW) / flux proof
(d)	Coil rated voltage	012	: 5.....48 VDC Coil rating table at page 3
(e)	Contact material	W	: AgSnO ₂
(f)	Terminal pitch	LA LB	: 10A high sensitive (250mW) 3.5mm pitch : 10A high sensitive (250mW) 5.0mm pitch
(g)	Special type	Nil BG	: Standard type (without gold plate) : Gold plated 3 μm

Actual marking does not carry the type name : "FTR"
 E.g.: Ordering code: FTR-K1AL012W-LA Actual marking: K1AL012W-LA

FTR-K1 SERIES

■ SPECIFICATION

Item	FTR-K1 (A, C) L () W - (LA, LB)		
Contact Data	Configuration		1 form A, 1 form C
	Construction		Single
	Material		AgSnO ₂
	Resistance (initial)		Max. 100mOhm at 1A, 6VDC
	Contact rating (resistive)		10A, 250VAC
	Max. carrying current *1		14A
	Max. switching voltage		440VAC
	Max. switching power		2,500VA
	Min. switching load *2		100mA, 5VDC
Life	Mechanical		Min. 20 x 10 ⁶ operations
	Electrical	AC contact rating	Min. 100 x 10 ³ operations (-LA and -LB 1 Form C) Min. 150 x 10 ³ operations (-LB 1 Form A)
Coil Data	Rated power (20 °C)		250mW
	Operate power (20 °C)		141mW
	Operating temperature range		-40 °C to +85 °C (no frost), (LB: -40 °C to +105 °C)
Timing Data	Operate (at nominal voltage)		Max. 15ms (without bounce, no diode)
	Release (at nominal voltage)		Max. 5ms (without bounce, no diode)
Insulation	Resistance (initial)		Min. 1,000MOhm at 500VDC
	Dielectric strength	Open contacts	1,000VAC (50/60Hz) 1min
		Contacts to coil	5,000VAC (50/60Hz) 1min
	Surge strength	Coil to contacts	10,000V / 1.2 x 50µs standard wave
	Clearance		10mm
	Creepage		10mm
	EN61810-1, VDE0435	Voltage	250V
		Pollution degree	3
		Material group	III a
	Category	C / 250V (Reference voltage) (VDE0110b)	
Other	Vibration resistance	Misoperation≥1us	10 to 55 to 10Hz single amplitude 0.35mm
		Endurance	10 to 55 to 10Hz single amplitude 0.75mm
	Shock	Misoperation≥1us	100m/s ² (11 ± 1ms)
		Endurance	1,000m/s ² (6 ± 1ms)
	Weight		Approximately 13g
	Sealing		Flux proof, RTII

* 1: Need to consider the heat from PCB when max. current is more than 10A.

* 2: Minimum switching loads mentioned above are reference values. Please perform the confirmation test with actual load before production since reference values may vary according to switching frequencies, environmental conditions and expected reliability levels.

■ COIL RATING

Coil Code	Rated Coil Voltage (VDC)	Coil Resistance +/- 10% (Ohm)	Must Operate Voltage (VDC) *	Must Release-Voltage (VDC) *	Rated Power (mW)
005	5	100	3.75	0.5	250
006	6	145	4.5	0.6	
009	9	325	6.75	0.9	
012	12	575	9	1.2	
018	18	1,300	13.5	1.8	
024	24	2,310	18	2.4	
048	48	9,216	36	4.8	

Note: All values in the table are valid for 20°C and zero contact current.

* Specified operate values are valid for pulse wave voltage.

Please use at rated coil voltage. Please refer to characteristic data and set up adequate voltage in case of use at over voltage.

■ SAFETY STANDARDS

Type	Compliance	Contact rating	
		1 Form A	1 Form C
UL	UL 508	Flammability: UL 94-V0 (plastics)	
	E63614	[FTR-K1AL ()W-(LA/AB)] 10A, 277VAC (resistive)	[FTR-K1CL ()W-(LA/LB)] 10A, 277VAC (resistive)
CSA	C22.2 No. 14 LR 40304	1/3hp, 125VAC 1/2hp, 277VAC Pilot duty: B300	[FTR-K1CL ()W-LB] 16A, 260VAC (N.O.)
VDE	IEC/EN61810-1 E60335-1 clause 15.3; 16.3; 29.1; 29.2; 29.3 EN60730-1 clause 12.1; 13.2; 20.1; 20.2; 20.3	[FTR-K1AL ()W-(LA/LB)] 10A, 250VAC, 150,000 cycles LA: 85 °C, LB:105 °C 3A, 250VAC (cosφ=0.4), 100,000 cycles, LA: 85 °C, LB: 105 °C	10A, 250VAC, 100,000 cycles, LA: 85 °C

CHARACTERISTIC DATA

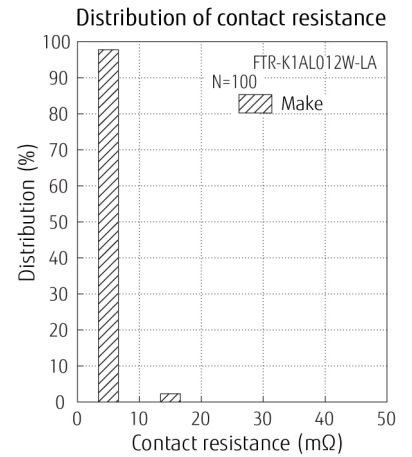
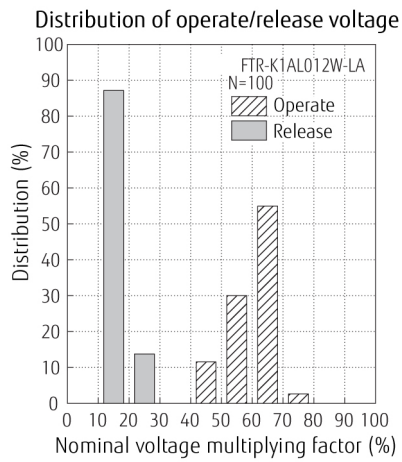
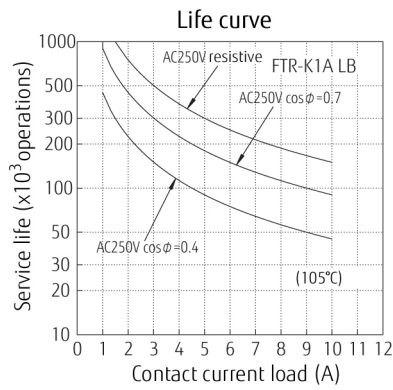
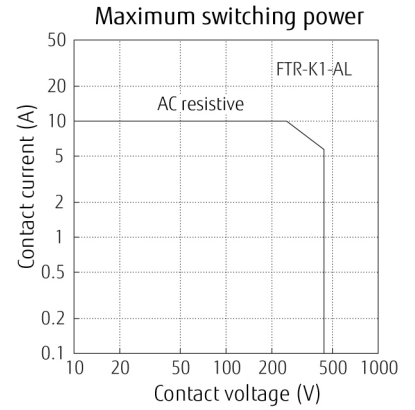
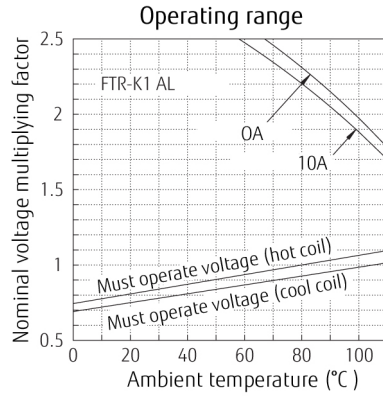
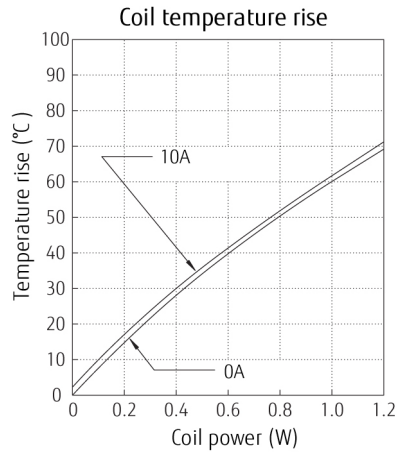

FTR-K1 SERIES

■ DIMENSIONS

FTR-K1AL()W-LA

● Dimensions

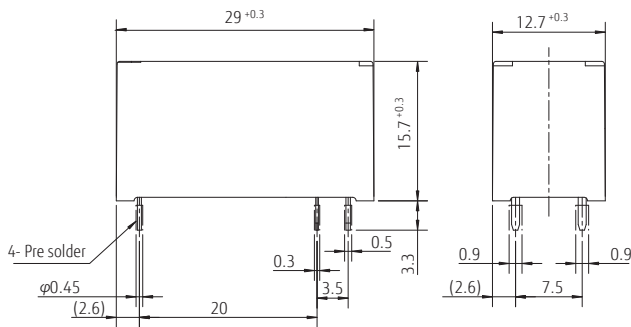

● Schematics

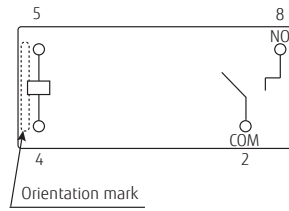

● PC board mounting hole layout (BOTTOM VIEW)

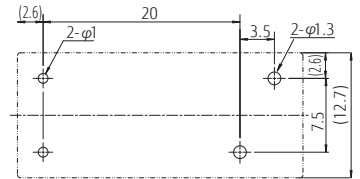

FTR-K1CL()W-LA

● Dimensions

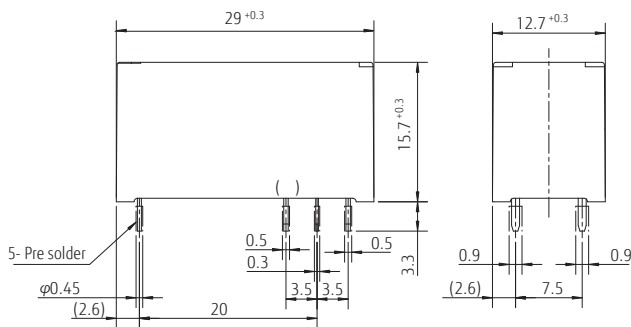

● Schematics

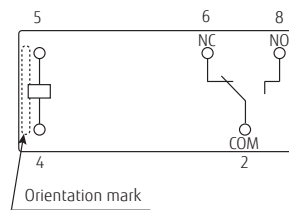

● PC board mounting hole layout (BOTTOM VIEW)

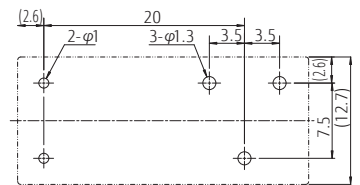

- * Dimensions of the terminals do not include thickness of pre-solder.
- * Tolerance of PC board mounting hole layout : ± 0.1 unless otherwise specified.

Unit: mm

FTR-K1 SERIES

■ DIMENSIONS

FTR-K1AL()W-LB

● Dimensions

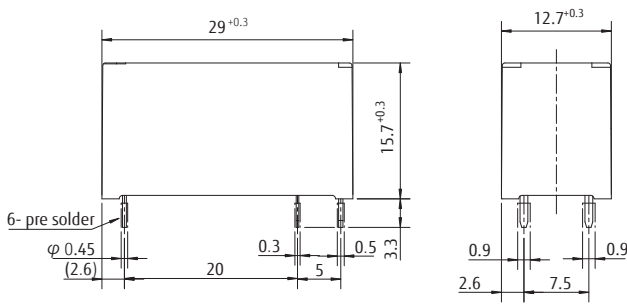

● Schematics

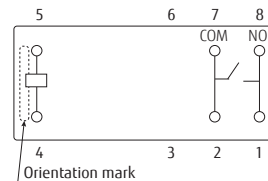

Connect terminal #1 and #8 on the PC board

● PC board mounting hole layout (BOTTOM VIEW)

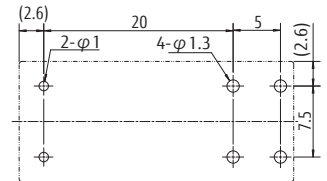

FTR-K1CL()W-LB

● Dimensions

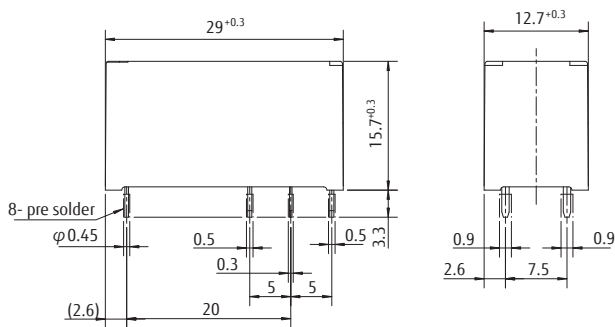

● Schematics

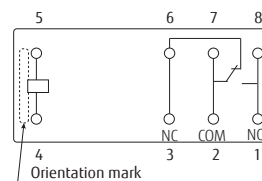

Connect terminal #1 and #8 on the PC board

● PC board mounting hole layout (BOTTOM VIEW)

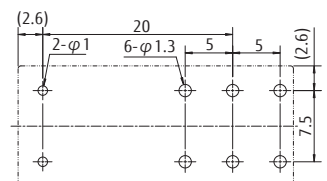

* Dimensions of the terminals do not include thickness of pre-solder.

* Tolerance of PC board mounting hole layout : ± 0.1 unless otherwise specified.

Unit: mm

Cautions

- All values mentioned in this datasheet are provided under ideal conditions. Please perform the confirmation test before actual use.
- Reflow soldering is prohibited.
- Do not use relays in the atmosphere with sulfide gas, chloride gas or nitric oxide. Contact resistance may increase.
- Do not use silicon or silicon-containing product or materials near relays. It may cause contact failure.

RoHS Compliance and Lead Free Information

1. General Information

- All relays produced by Fujitsu Components are compliant with RoHS directive 2011/65/EU including amendments.
- Cadmium as used in electrical contacts is exempted from the RoHS directives. As per Annex III of directive 2011/65/EU.
- All relays are lead-free. Please refer to Lead-Free Status Info for older date codes at: <http://www.fujitsu.com/downloads/MICRO/fcai/relays/lead-free-letter.pdf>
- Lead free solder plating on relay terminals is Sn-3.0Ag-0.5Cu, unless otherwise specified. This material has been verified to be compatible with PbSn assembly process.

2. Recommended Lead Free Solder Condition

- Recommended solder Sn-3.0Ag-0.5Cu.

Flow Solder Condition:

Pre-heating: maximum 120°C
within 90 sec.
Soldering: dip within 5 sec. at
255°C ± 5°C solder bath
Relay must be cooled by air immediately
after soldering

Solder by Soldering Iron:

Soldering Iron 30-60W
Temperature: maximum 350-360°C
Duration: maximum 3 sec.

We highly recommend that you confirm your actual solder conditions

3. Moisture Sensitivity

- Moisture Sensitivity Level standard is not applicable to electromechanical relays, unless otherwise indicated.

4. Tin Whiskers

- Dipped SnAgCu solder is known as presenting a low risk to tin whisker development. No considerable length whisker was found by our in house test.

Fujitsu Components International Headquarter Offices

Japan FUJITSU COMPONENT LIMITED Shinagawa Seaside Park Tower 19F, 12-4, Higashi-shinagawa 4-chome, Shinagawa-ku, Tokyo, 140-0002, Japan Tel: (81-3) 3450-1682 Fax: (81-3) 3474-2385 Email: fcl-contact@cs.jp.fujitsu.com Web: www.fujitsu.com/jp/fcl/	Asia Pacific FUJITSU COMPONENTS ASIA, LTD. 102E Pasir Panjang Road #01-01 Citilink Warehouse Complex Singapore 118529 Tel: (65) 6375-8560 Fax: (65) 6273-3021 Email: fcal@sg.fujitsu.com Web: www.fujitsu.com/sg/products/devices/components	Korea FUJITSU COMPONENTS KOREA LIMITED Alpha Tower #403, 645 Samsyeong-dong, Bundang-gu, Seongnam-si, Gyeonggi-do, 13524 Korea Tel: (82) 31-708-7108 Fax: (82) 31-709-7108 Email: fcal@sg.fujitsu.com www.fujitsu.com/sg/products/devices/components/
North and South America FUJITSU COMPONENTS AMERICA, INC 2290 North First Street, Suite 212 San Jose, CA 95131, USA Tel: (1-408) 745-4900 Fax: (1-408) 745-4970 Email: components@us.fujitsu.com Web: us.fujitsu.com/components	China FUJITSU ELECTRONIC COMPONENTS (SHANGHAI) CO., LTD. Unit 4306, InterContinental Center 100 Yu Tong Road, Shanghai 200070, China Tel: (86-21) 3253 0998 Fax: (86-21) 3253 0997 Email: fcal@sg.fujitsu.com Web: www.fujitsu.com/sg/products/devices/components	
Europe FUJITSU COMPONENTS EUROPE B.V. Diamantlaan 25 2132 WV Hoofddorp Netherlands Tel: (31-23) 5560910 Fax: (31-23) 5560950 Email: info@fceu.fujitsu.com Web: www.fujitsu.com/uk/components	Hong Kong FUJITSU COMPONENTS HONG KONG CO., LTD Unit 506, Inter-Continental Plaza No.94 Granville Road, Tsim Sha Tsui, Kowloon, Hong Kong Tel: (852) 2881-8495 Tex: (852) 2894-9512 Email: fcal@sg.fujitsu.com Web: www.fujitsu.com/sg/products/devices/components/	

©2018 Fujitsu Components Europe B.V. All rights reserved. All trademarks or registered trademarks are the property of their respective owners.

The contents, data and information in this datasheet are provided by Fujitsu Component Ltd. as a service only to its user and only for general information purposes.

The use of the contents, data and information provided in this datasheet is at the users' own risk.

Fujitsu has assembled this datasheet with care and will endeavor to keep the contents, data and information correct, accurate, comprehensive, complete and up to date.

Fujitsu Components Europe B.V. and affiliated companies do however not accept any responsibility or liability on their behalf, nor on behalf of its employees, for any loss or damage, direct, indirect or consequential, with respect to this datasheet, its contents, data, and information and related graphics and the correctness, reliability, accuracy, comprehensiveness, usefulness, availability and completeness thereof.

Nor do Fujitsu Components Europe B.V. and affiliated companies accept on their behalf, nor on behalf of its employees, any responsibility or liability for any representation or warrant of any kind, express or implied, including warranties of any kind for merchantability or fitness for particular use, with respect to these datasheets, its contents, data, information and related graphics and the correctness, reliability, accuracy, comprehensiveness, usefulness, availability and completeness thereof. Rev. August 29, 2018

X-ON Electronics

Largest Supplier of Electrical and Electronic Components

Click to view similar products for [General Purpose Relays](#) category:

Click to view products by [Fujitsu](#) manufacturer:

Other Similar products are found below :

[PCN-105D3MH,000](#) [59641F200](#) [LY1SAC110120](#) [5X827E](#) [5X837F](#) [5X840F](#) [5X842F](#) [5X848E](#) [LY2N-AC120](#) [LY2S-AC220/240](#) [LY2-US-AC120](#) [LY3-US-AC120](#) [LY4F-UA-DC12](#) [LY4F-UA-DC24](#) [LY4F-US-AC120](#) [LY4F-US-AC240](#) [LY4F-US-DC24](#) [LY4F-VD-AC110](#) [LYQ20DC12](#) [M115C60](#) [M115N010](#) [M115N0150](#) [6031007G](#) [603-12D](#) [61211T0B4](#) [61212T400](#) [61222Q400](#) [61243B600](#) [61243C500](#) [61243Q400](#) [61311BOA2](#) [61311BOA6](#) [61311BOA8](#) [61311C0A2](#) [61311COA1](#) [61311COA6](#) [61311F0A2](#) [61311QOA1](#) [61311QOA4](#) [61311T0D6](#) [61311TOA6](#) [61311TOA7](#) [61311TOB3](#) [61311TOB4](#) [61311U0A6](#) [61312Q600](#) [61312T400](#) [61312T600](#) [61313U200](#) [61313U400](#)