

COMPANY HISTORY

1973,3 月	與日本福島雙羽簽訂技術合作合約
January 1973	Signed technical cooperation agreement with Fukushima Futaba in Japan.
1973,10 月	台灣雙羽電機股份有限公司正式成立
October 1973	Founded as Futaba Electric Co., Ltd.
1974, 9 月	開始量產氧化金屬膜電阻器
November 1999	Mass production of Metal Oxide Film Resistor.
1997,6 月	成立大陸廠,雙羽電子(深圳)有限公司
June 1997	Established Shenzhen plant in China.
1997,10 月	台灣廠取得 ISO 9000 : 1994 認證
October 1997	Futaba Taiwan HQ achieved ISO 9000 : 1994 certification.
1998,1 月	開始量產高阻值金屬釉電阻器
January 1998	Mass production of High Meg Metal Glaze Resistor.
1999,3 月	大陸廠(深圳)取得 ISO 9000 : 1994 認證
March 1999	Shenzhen plant achieved ISO 9000: 1994 certification.
1999,11 月	成立大陸廠: 雙葉電子廠
November 1999	Established Shuangya Electronics Co. in China.
2002,8 月	台灣廠取得 ISO 9001 : 2000 改版認證
August 2002	Futaba Taiwan HQ achieved ISO 9001: 2000 certification.
2003.1 月	大陸廠(深圳)取得 ISO 9001 : 2000 改版認證
January, 2003	Shenzhen plant achieved ISO 9001: 2000 certification.
2003.1 月	導入無鉛產品; 導入 RoHS
January 2003	Implemented Lead-Free products.
2003.4 月	台灣廠取得 SONY 綠色夥伴認證
April 2003	Futaba Taiwan HQ achieved SONY green partner certification.
2003,9 月	成立大陸廠,雙羽電子(蘇州)有限公司
September 2003	Established Suzhou plant in China.
2004,8 月	大陸廠(蘇州)取得 ISO 9001 : 2004 認證
August 2004	Suzhou plant achieved ISO 9001: 2004 certification.
2005,12 月	大陸廠(深圳)取得 ISO 14001 : 2004 認證
December 2005	Shenzhen plant achieved ISO 14001: 2004 certification.
2006,3 月	大陸廠(蘇州)取得 ISO 14001 : 2004 認證
March 2006	Suzhou plant achieved ISO 14001: 2004 certification.
2008,8 月	導入無鹵產品
August 2008	Implemented Halogen-Free products.
2009,8 月	台灣及大陸廠均取得 ISO 9001 : 2008 認證(台灣廠、深圳廠、雙葉廠、蘇州廠)
August 2009	Taiwan, Shenzhen, Shuangya and Suzhou achieved ISO 9001: 2008 certification.
2010, 2 月	大陸廠(蘇州)取得 TS 16949 : 2009 認證
February 2010	Suzhou plant achieved TS 16949: 2009 certification.
2012, 7 月	大陸廠(雙葉)更名為富羽雙華電阻材料有限公司
July 2012	Shuangya renamed to Futaba Electronics Co., Ltd.

INDEX

固定電阻器 Fixed Resistors

品類 Type	產品名稱 Product Name	品名 Type	頁 Page
Film	氧化金屬膜電阻器	METAL OXIDE FILM RESISTOR	RS 4 • 5
	金屬皮膜固定電阻器	FIXED METAL FILM RESISTOR	RN 6 • 7
	金屬皮膜精密電阻器	METAL FILM PRECISION RESISTOR	RP 8 • 9
High	金屬釉電阻器	METAL GLAZE RESISTOR	RM 10 • 11
	耐突波電阻器	SURGE RESISTOR	RV 12 • 13
	高阻值電阻器	HIGH RESISTANCE RESISTOR	RR 14 • 15
Fusing	保險絲電阻器	FUSIBLE RESISTOR	RF 16 • 17
	電流式保險絲電阻器	RATED CURRENT FUSIBLE RESISTOR	RFA 18 • 19
	高能量突波繞線保險絲電阻器	HEAT ENERGY SURGE WIRE WOUND FUSIBLE RESISTOR	WF 20 • 21
	可復式水泥繞線電阻組合溫度保險絲電阻器	NON-SMOKE THERMAL FUSE RESISTOR	RFT 22 • 23
	防爆保險絲電阻器	ANTI-BURST FUSIBLE RESISTOR	RFB / RFF 24 • 25
Wire	繞線電阻器	WIRE WOUND RESISTOR	RW 26 • 27
Wound	無感電阻器	NON INDUCTIVE RESISTOR	NW/NM/NV 28 • 29
Ceramic Cased	金屬板電阻器	METAL PLATE CEMENT RESISTOR	MPC / MPH 30 • 31
	薄型金屬板電阻器	METAL PLATE CEMENT RESISTOR	MPM 32 • 33
	薄型電阻器	METAL PLATE CEMENT RESISTOR	MPT / MPQ 34 • 35
	水泥電阻器	CEMENT RESISTOR	RG 36 • 37
	高絕緣水泥電阻器	CEMENT RESISTOR	RGK 38 • 39
	電流偵測電阻器	CURRENT SENSOR RESISTOR	RGC 40 • 41
	高脈衝繞線電阻器(可加溫度保險絲)	HIGH PULSE WIRE WOUND RESISTOR	HVW 42 • 43
Aluminum Cased	黃金鋁殼電阻器	ALUMINUM CASED POWER RESISTOR	GR 44 • 45
	薄型鋁殼電阻器	FLAT TYPE METAL CLAD WIRE WOUND RESISTOR	GH 46 • 47
	方型鋁殼電阻器	SQUARE SHAPE ALUMINUM SHELL RESISTOR	RA 48 • 49
	船型鋁殼電阻器	TRAPEZOID ALUMINUM SHELL RESISTOR	RAMH 50 • 51
High Power	大功率電阻器	POWER WIRE WOUND RESISTOR	RQ 52 • 53
Other	塗裝絕緣型 0Ω電阻器	COAT-INSULATED ZERO OHM RESISTOR	RZ 54 • 55
	低阻值電阻器	LOW RESISTANCE RESISTOR	ST 56 • 57
	低阻值電阻器	LOW RESISTANCE RESISTOR	LR 58 • 59
	模造電阻器	POWER CHIP RESISTOR	MR 60 • 61

附錄 APPENDIX

造型 FORMING		頁 Page
TAPING(A52/A64/A73) • L TYPE • C TYPE • FA5 TYPE • FB5 TYPE • FC5 TYPE • M TYPE • D TYPE • Y TYPE • YT TYPE • FT TYPE		62 • 63
RG SERIES TYPE	P TYPE • Z TYPE • M TYPE • S TYPE • H TYPE	64
RESISTANCE TOLERANCE / BASIC VALUE E24 & E96		65
RESISTOR LOADING CALCULATION AND SURGE TEST METHOD		66 • 69

額定電力 Power Rating (W)							電阻公差 Resistance Tolerance							歐洲 RoHS	中國 RoHS	品名 Type	頁 Page	
<1/4	1/4	1/2	1	2	3	>3	±0.01%	±0.05%	±0.1%	±0.5%	±1%	±2%	±5%	>±5%				
												⊙	⊙		●	○	RS	4・5
							⊙	⊙	⊙	⊙	⊙	⊙	⊙		●		RN	6・7
							⊙	⊙	⊙	⊙					●		RP	8・9
									⊙	⊙	⊙	⊙	⊙		●	○	RM	10・11
										⊙	⊙	⊙			●		RV	12・13
										⊙	⊙	⊙			●		RR	14・15
													⊙		●		RF	16・17
															●		RFA	18・19
													⊙		●		WF	20・21
													⊙		●		RFT	22・23
													⊙		●		RFB / RFF	24・25
									△	⊙	⊙	⊙	⊙		●	○	RW	26・27
												⊙	⊙		●	○	NW / NM / NV	28・29
									△	⊙	⊙	⊙	⊙		●	○	MPC / MPH	30・31
													⊙	⊙	●	○	MPM	32・33
										⊙	⊙	⊙	⊙		●	○	MPT / MPQ	34・35
										⊙	⊙	⊙			●		RG	36・37
										△	△	⊙			●		RGK	38・39
									△	⊙	⊙	⊙			●		RGC	40・41
													⊙		●		HVW	42・43
										⊙	⊙	⊙			●		GR	44・45
													⊙		●		GH	46・47
													⊙		●		RA	48・49
													⊙		●		RAMH	50・51
										△	⊙	⊙			●		RQ	52・53
															●		RZ	54・55
										⊙	⊙	⊙			●		ST	56・57
										⊙	⊙	⊙			●		LR	58・59
									△	⊙	⊙	⊙			●		MR	60・61

NOTE:△ Please contact our sales

額定電力 Power Rating (W)	頁 Page
AVAILABLE : 1/4W~5W	62・63
AVAILABLE : 1W~40W	64
RESISTANCE TOLERANCE / BASIC VALUE E24 & E96	65
RESISTOR LOADING CALCULATION AND SURGE TEST METHOD	66・69

POWER TYPE

RSU 氧化金屬膜電阻器
METAL OXIDE FILM RESISTOR (Standard Type)

RSS 小型氧化金屬膜電阻器
METAL OXIDE FILM RESISTOR (Small Type)

RSP 超小型氧化金屬膜電阻器
METAL OXIDE FILM RESISTOR (Super Small Type)



塗裝顏色 (Coating Color) :

標準品 (Standard Type) 灰色 (Gray)

小型品 (Small Type) 粉紅色 (Pink)

超小型品 (Super Small Type) 粉紅色 (Pink)

標示 (Marking) :

色碼 (Color Code) (1/4W、S1/2W)

文字 (Alphanumeric) (1/2W~S5W)

特性 Feature

◎ 使用不燃性塗料，具不燃與絕緣之安全特性(UL94 V-0)

Flameproof and insulating coating designed to assure safe usage by special non-flammable silicon-base.

(Equivalent to UL94 V-0)

◎ 小型化能高密度插裝

Small size are good for high density application.

◎ 高信賴性

High reliability.

◎ 耐熱性佳,表面溫昇低

High thermal stability and low surface temperature rise.

◎ 產品符合歐盟 RoHS 要求

Products is compliance the EU-RoHS request.

參考規格 Reference standards

● JIS C 5201-1

結構圖 Construction

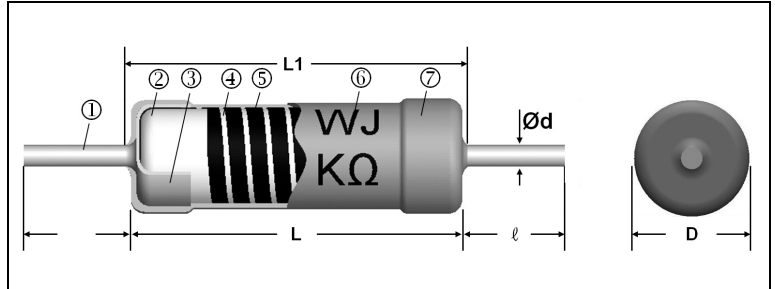

1	端子線	Lead wire	5	導電皮膜	Conductive film
2	瓷棒	Ceramic base	6	標示	Marking or color code
3	鐵帽	Cap			
4	切割線	Helical cutting groove	7	絕緣塗料	Insulation coat

外型尺寸 Dimensions

Rated Power (W)	Dimensions (mm)					Weight (g) (1000pcs)
	L	L1 Max.	D	Ød	ℓ	
1/4, S1/2, P1	6.0±0.5	7	2.4±0.3	0.6±0.05 P2:0.7±0.05	28±2	210
1/2, S1, P2	9±0.5	11	3.0±0.5		28±3	285
1, S2, P3	12±1	15	4.0±0.5	0.8±0.05	38±3	728
2, S3, P5	16±1	18	5.5±0.5			1380
3, S5	25±1	28	8.5±0.5			3768

料號編碼 Type composition

例 Example

RS	U	14	J	R100	A520	NH
型名 Type	品名 Size	額定功率 Rated Power	誤差值 Tolerance	電阻值(Ω) Resistance	二次加工 Forming	端子線 Lead Wire
	U: Standard	14:1/4W	F±1%	R100=0.1	See table below	熱鍍線 Heat plated
	S: Small	12:1/2W	G±2%	1R00=1		
	P: Super small	01:1W	J±5%	10R0=10		
		02:2W		1000=100		
		03:3W		1001=1K		
		05:5W		1002=10K		
				1003=100K		

額定 Ratings

Rated Power (W)	阻值範圍 Resistance Range (Ω)			最高使用電壓 Max. Working Voltage	最高過負荷電壓 Max. Overload Voltage	耐電壓 Dielectric Withstanding Voltage	溫度係數 T.C.R.	包裝 Taping/Ammo, Forming/Bulk pack (pcs)					
	F±1% (E96)	G±2% (E24)	J±5% (E24)					A52	A64	A73	FT	YT	L
1/4, S1/2, P1	0.1 ~ 910K			250V	500V	250V	F±1%: ±100ppm/°C	2500	—	—	2000	—	2500
1/2, S1, P2	0.1 ~ 33K	0.1 ~ 470K						2000	—	—	2000	2000	2500
1, S2, P3	0.1 ~ 33K	0.1 ~ 750K		350V	700V	350V	G±2%: ±200ppm/°C	1000	1000	—	1000	1000	1000
2, S3, P5	0.1 ~ 33K	0.1 ~ 330K						500	500	500	—	1000	1000
3, S5	0.1 ~ 33K	0.1 ~ 100K						—	—	—	—	—	200

■ 額定溫度下降曲線圖 Derating curve

例 Example



■ 表面溫度上升

Surface Temperature Rise Vs. Loaded Power



■ 二次加工對應表 Taping & Forming Matrix

Rated Power (W)	Taping			Radial Taping		L Forming					C Forming				F Forming				M Forming			D Forming		
	A52	A64	A73	FT	YT	L10	L12.5	L15	L20	L30	C12.5	C15	C20	C30	FA5	FB5	FC5	FD5	M12.5	M15	M20	D12.5	D15	D20
1/4,S1/2,P1	○	-	-	○	-	○	-	-	-	-	-	-	-	-	-	○	-	-	-	-	-	-	-	-
1/2,S1,P2	○	-	-	○	○	-	○	-	-	-	○	-	-	-	○	○	○	○	○	-	-	-	○	-
1,S2,P3	○	-	-	○	○	-	-	○	-	-	-	○	-	-	○	○	○	○	-	○	-	-	-	○
2,S3,P5	○	○	○	-	○	-	-	-	○	-	-	-	○	-	○	○	○	○	-	-	○	-	-	○
3,S5	-	-	-	-	-	-	-	-	-	○	-	-	-	○	-	-	-	-	-	-	-	-	-	-

■ 試驗條件與方法 The testing method and condition.

試驗項目 Test Items	規格值 Performance Requirements	試驗方法 Test Methods and Standard.(JISC5201-1)
電阻值 Resistance	規定的誤差值內 Within of specified tolerance	測量點從端蓋 10mm Measuring points are distance 10mm from the end cap(4.5)
溫度係數 T.C.R.	規定值內 Within of specified T.C.R.	室溫+100°C Room temperature +100°C(4.8)
短時間過負荷 Short time overload	±(1%+0.05Ω)	6.25 倍額定功率，5 秒 6.25 times the rated power for 5 seconds(4.13)
負荷壽命 Load life	±(5%+0.1Ω)	Rated voltage at 70°C for 1,000 hours 1.5hr ON / 0.5hr OFF Cycles(4.25.1)
耐濕負荷壽命 Load life in humidity	±(5%+0.1Ω)	10% rate power load 40°C, 95% RH for 1,000 hours 1.5h ON / 0.5h OFF cycle(4.24)
耐濕性 Moisture resistance	±(1%+0.05Ω)	40°C，95% RH，240 小時 40°C, 95% RH for 240 hours
溫度循環 Temperature cycle	±(1%+0.05Ω)	5 cycles for -25°C (30min) : room temp. (30min) ~ +85°C (30min) room temp. (30min)(4.19)(4.19)
斷續過負荷 Intermittent overload	±(5%+0.1Ω)	Applicable more than 100Ω : Rated voltage ×3 1s ON / 25s OFF , 10,000 cycles(4.13)
焊錫耐熱 Resistance to soldering heat	±(1%+0.05Ω)	260°C ± 5°C for 10 seconds (焊錫槽) 350°C ± 10°C for 3.5 seconds (手焊錫)(4.18)
絕緣電阻 Insulation resistance	>1,000MΩ	500V 絕緣測試 1 分鐘 500V insulation test 1min.(4.6.1)

POWER TYPE

RNU 金屬皮膜固定電阻器
FIXED METAL FILM RESISTOR (Standard Type)

RNS 小型金屬皮膜固定電阻器
FIXED METAL FILM RESISTOR (Small Type)



結構圖 Construction



1	端子線	Lead wire	5	導電皮膜	Conductive film
2	瓷棒	Ceramic base	6	標示	Marking or color code
3	鐵帽	Cap			
4	切割線	Helical cutting groove	7	絕緣塗料	Insulation coat

塗裝顏色 (Coating Color) :

S1/2W 深藍色 Dark blue

others 淺藍色 Light blue,

標示 (Marking) :

色碼 (Color Code) (1/8,S1/4,1/4,S1/2)

文字 (Alphanumeric) ($\geq 1/2W$)

外型尺寸 Dimensions

Rated Power (W)	Dimensions (mm)					Weight (g) (1000pcs)
	L	L1 Max.	D	$\varnothing d$	ℓ	
1/8,S1/4	3.5 \pm 0.5	5	1.7 \pm 0.3	0.45 \pm 0.05	27 \pm 3	110
1/6	3.5 \pm 0.5	5	1.7 \pm 0.4	0.45 \pm 0.05	27 \pm 3	110
1/4,S1/2	6.0 \pm 0.5	7	2.3 \pm 0.3	0.52 \pm 0.05	27 \pm 3	210
1/2,S1	9 \pm 1	11	3.2 \pm 0.5	0.56 \pm 0.05	27 \pm 3	285
1,S2	12 \pm 1	15	4.0 \pm 0.5	0.8 \pm 0.05	38 \pm 3	728
2,S3	16 \pm 1	18	5.5 \pm 0.5	0.8 \pm 0.05	38 \pm 3	1380

特性 Feature

◎高精密低溫度係數金屬膜電阻器

High precision and low T.C.R. of metal film resistor.

◎長期穩定性佳

Excellent stability for long time service.

◎可自動插件

Automatic insertion is applicable.

◎產品符合歐盟 RoHS 要求

Products is compliance the EU-RoHS request.

料號編碼 Type composition

例 Example

RN	U	14	J	10R0	A520	NH
型名 Type	品名 Size	額定功率 Rated Power	誤差值 Tolerance	電阻值(Ω) Resistance	二次加工 Forming	端子線 Lead Wire
	U: Standard	18:1/8W	F \pm 1%	10R0=10	See table below	熱鍍線 Heat plated
	S: Small	14:1/4W	G \pm 2%	1000=100		
		12:1/2W	J \pm 5%	1001=1K		
		01:1W	J \pm 5%	1002=10K		
		02:2W		1003=100K		
		03:3W		1004=1M		

參考規格 Reference standards

● JIS C 5201-1

額定 Ratings

Rated Power (W)	阻值範圍 Resistance Range (Ω)			最高使用電壓 Max. Working Voltage	最高過負荷電壓 Max. Overload Voltage	耐電壓 Dielectric Withstanding Voltage	溫度係數 T.C.R.	包裝 Taping/Ammo,Forming/Bulk pack (pcs)					
	F \pm 1% (E96)	G \pm 2% (E24)	J \pm 5% (E24)					A52	A64	A73	FT	YT	L
1/8,1/6, S1/4	10Ω~1M			200V	400V	300V	\pm 100ppm/ $^{\circ}$ C	5000	-	-	-	-	-
1/4,S1/2	10Ω~2.2M			250V	500V	500V		2500	-	-	2000	-	2500
1/2,S1	10Ω~5.1M			350V	700V			2000	-	-	2000	2000	2500
1,S2				1000				1000	-	1000	1000	1000	
2,S3				500				500	500	-	1000	1000	

■ 額定溫度下降曲線圖 Derating curve

例 Example



■ 二次加工對應表 Taping & Forming Matrix

Rated Power (W)	Taping			Radial Taping		L Forming					C Forming				F Forming				M Forming			D Forming			
	A26	A52	A64	FT	YT	L10	L12.5	L15	L20	L30	C12.5	C15	C20	C30	FA5	FB5	FC5	FD5	M12.5	M15	M20	D12.5	D15	D20	
1/8,1/6	○	-	-	-	-	-	-	-	-	-	-	-	-	-	-	-	-	-	-	-	-	-	-	-	-
1/4,S1/2	-	○	-	○	-	○	-	-	-	-	-	-	-	-	○	○	○	○	-	-	-	-	-	-	-
1/2,S1	-	○	-	○	○	-	○	-	-	-	○	-	-	-	○	○	○	○	○	-	-	○	-	-	-
1,S2	-	○	○	○	○	-	-	○	-	-	-	○	-	-	○	○	○	○	-	○	-	-	○	-	-
2,S3	-	○	○	-	○	-	-	-	○	-	-	-	○	-	○	○	○	○	-	-	○	-	-	-	○

■ 試驗條件與方法 The testing method and condition.

試驗項目 Test Items	規格值 Performance Requirements	試驗方法 Test Methods and Standard.(JISC5201-1)
電阻值 Resistance	規定的誤差值內 Within of specified tolerance	測量點從端蓋 10mm Measuring points are distance 10mm from the end cap(4.5)
溫度係數 T.C.R.	規定值內 Within of specified T.C.R.	室溫+100°C Room temperature +100°C(4.8)
短時間過負荷 Short time overload	±(1%+0.05Ω)	6.25 倍額定功率，5 秒 6.25 times the rated power for 5 seconds(4.13)
負荷壽命 Load life	±(1.5%+0.05Ω)	Rated voltage at 70°C for 1,000 hours 1.5hr ON / 0.5hr OFF Cycles(4.25.1)
耐濕負荷壽命 Load life in humidity	±(5%+0.1Ω)	10% rate power load 40°C, 95% RH for 1,000 hours 1.5h ON / 0.5h OFF cycle(4.24)
耐濕性 Moisture resistance	±(1%+0.05Ω)	40°C · 95% RH · 240 小時 40°C, 95% RH for 240 hours
溫度循環 Temperature cycle	±(1%+0.05Ω)	5 cycles for -25°C (30min) : room temp. (30min) ~ +85°C (30min) room temp. (30min)(4.19)
斷續過負荷 Intermittent overload	±(1%+0.05Ω)	Applicable more than100Ω : Rated voltage ×3 1s ON / 25s OFF , 1,000 cycles(4.13)
焊錫耐熱 Resistance to soldering heat	±(1%+0.05Ω)	260°C ± 5°C for 10 seconds (焊錫槽) 350°C ± 10°C for 3.5 seconds (手焊錫)(4.18)
絕緣電阻 Insulation resistance	>1,000MΩ	500V 絕緣測試 1 分鐘 500V insulation test 1min.(4.6.1)

POWER TYPE

RPU 金屬皮膜精密電阻器
METAL FILM PRECISION RESISTOR (Standard Type)

RPS 小型金屬皮膜精密電阻器
METAL FILM PRECISION RESISTOR (Small Type)



結構圖 Construction

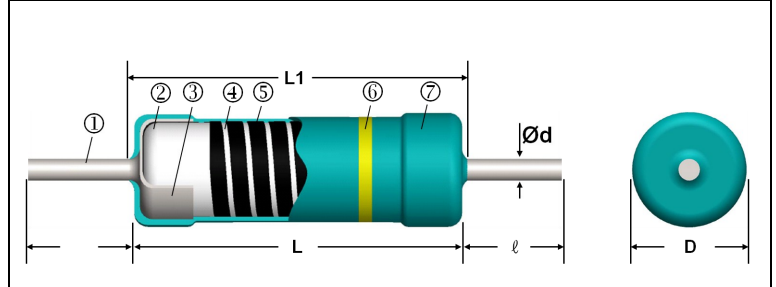

1	端子線	Lead wire	5	導電皮膜	Conductive film
2	瓷棒	Ceramic base	6	標示	Marking or color code
3	鐵帽	Cap			
4	切割線	Helical cutting groove	7	絕緣塗料	Insulation coat

塗裝顏色(Coating Color) :

≤ 1/6W Blue epoxy paint

≤ 1/6W 藍色環氧樹脂塗料

≥ 1/4W RPU/ gray; RPS/ pink

≥ 1/4W RPU / 灰色 ; RPS / 粉紅色

標示 (Marking) :

色碼 (Color Code) (≤ S1/2)

文字 (Alphanumeric) (1/2~S3)

外型尺寸 Dimensions

Rated Power (W)	Dimensions (mm)					Weight (g) (1000pcs)
	L	L1 Max.	D	Ød	l	
1/8, 1/6, S1/4	3.5±0.5	5	1.7±0.3	0.45±0.05	27±3	110
1/4, S1/2	6.0±0.5	7	2.3±0.3	0.6±0.05	27±3	210
1/2, S1	9±1	11	3.2±0.5	0.6±0.05	27±3	285
1, S2	12±1	15	4.0±0.5	0.8±0.05	38±3	728
2, S3	16±1	18	5.5±0.5	0.8±0.05	38±3	1380

特性 Feature

◎高精密低溫度係數金屬膜電阻器.電阻值容許差± 0.01%

High precision and low T.C.R. of metal film resistor
and resistance tolerance±0.01%.

◎長期穩定性佳

Excellent stability for long time service.

◎產品符合歐盟 RoHS 要求

Products is compliance the EU-RoHS request.

料號編碼 Type composition

例 Example

RP	U	14	F	R100	A520	NH
型名 Type	品名 Size	額定功率 Rated Power	誤差值 Tolerance	電阻值(Ω) Resistance	二次加工 Forming	端子線 Lead Wire
	U: Standard	18:1/8W	F±1%	10R0=10	See table below	熱鍍線 Heat plated
	S: Small	14:1/4W	D±0.5%	1000=100		
		12:1/2W	B±0.1%	1001=1K		
		01:1W		1002=10K		
		02:2W		1003=100K		

參考規格 Reference standards

● JIS C 5201-1

額定 Ratings

Rated Power (W)	阻值範圍 Resistance Range (Ω)	最高使用電壓 Max. Working Voltage	最高過負荷電壓 Max. Overload Voltage	耐電壓 Dielectric Withstanding Voltage	溫度係數 T.C.R.	包裝 Taping/Ammo, Forming/Bulk pack (pcs)					
	0.01%、0.02%、0.05%、0.1%、1%					A26	A52	A64	FT	YT	L
1/8, 1/6 S1/4	10Ω~100K	200V	250V	300V	± 100ppm/°C	5000	—	—	—	—	—
1/4, S1/2		250V				350V	500V	—	2500	—	2000
1/2, S1			—	2000				—	1000	2000	2500
1, S2			350V	700V				—	1000	1000	1000
2, S3		—				500	500	—	1000	1000	

■ 額定溫度下降曲線圖 Derating curve

例 Example



■ 二次加工對應表 Taping & Forming Matrix

Rated Power (W)	Taping			Radial Taping		L Forming					C Forming				F Forming				M Forming			D Forming			
	A26	A52	A64	FT	YT	L10	L12.5	L15	L20	L30	C12.5	C15	C20	C30	FA5	FB5	FC5	FD5	M12.5	M15	M20	D12.5	D15	D20	
1/8,1/6	○	-	-	-	-	-	-	-	-	-	-	-	-	-	-	-	-	-	-	-	-	-	-	-	-
1/4,S1/2	-	○	-	○	-	○	-	-	-	-	-	-	-	-	○	○	○	○	-	-	-	-	-	-	-
1/2,S1	-	○	-	○	○	-	○	-	-	-	○	-	-	-	○	○	○	○	○	-	-	○	-	-	-
1,S2	-	○	○	○	○	-	-	○	-	-	-	○	-	-	○	○	○	○	-	○	-	-	○	-	-
2,S3	-	○	○	-	○	-	-	-	○	-	-	-	○	-	○	○	○	○	-	-	○	-	-	-	○

■ 試驗條件與方法 The testing method and condition.

試驗項目 Test Items	規格值 Performance Requirements	試驗方法 Test Methods and Standard.(JISC5201-1)
電阻值 Resistance	規定的誤差值內 Within of specified tolerance	測量點從端蓋 10mm Measuring points are distance 10mm from the end cap(4.5)
溫度係數 T.C.R.	規定值內 Within of specified T.C.R.	室溫+100°C Room temperature +100°C(4.8)
短時間過負荷 Short time overload	±(1%+0.05Ω)	6.25 倍額定功率，5 秒 6.25 times the rated power for 5 seconds(4.13)
負荷壽命 Load life	±(1.5%+0.05Ω)	Rated voltage at 70°C for 1,000 hours 1.5hr ON / 0.5hr OFF Cycles(4.25.1)
耐濕負荷壽命 Load life in humidity	±(5%+0.1Ω)	10% rate power load 40°C, 95% RH for 1,000 hours 1.5h ON / 0.5h OFF cycle(4.24)
耐濕性 Moisture resistance	±(1%+0.05Ω)	40°C · 95% RH · 240 小時 40°C, 95% RH for 240 hours
溫度循環 Temperature cycle	±(1%+0.05Ω)	5 cycles for -25°C (30min) : room temp. (30min) ~ +85°C (30min) room temp. (30min)(4.19)
斷續過負荷 Intermittent overload	±(1%+0.05Ω)	Applicable more than 100Ω : Rated voltage ×3 1s ON / 25s OFF , 10,000 cycles(4.13)
焊錫耐熱 Resistance to soldering heat	±(1%+0.05Ω)	260°C ± 5°C for 10 seconds (焊錫槽) 350°C ± 10°C for 3.5 seconds (手焊錫)(4.18)
絕緣電阻 Insulation resistance	>1,000MΩ	500V 絕緣測試 1 分鐘 500V insulation test 1min.(4.6.1)

DISCHARGE PATH RESISTOR

RMU 金屬釉電阻器
METAL GLAZE RESISTOR (Standard Type)

RMS 小型金屬釉電阻器
METAL GLAZE RESISTOR (Small Type)

RMH 大型金屬釉電阻器
METAL GLAZE RESISTOR (Large-scale Type)



塗裝顏色(Coating Color) :

標準品 Standard Type (1/6W, 1/4W Dark blue ,other pink)

小型品 Small Type (≥ 1/2W Pink)

大型品 Large-scale Type (Pink)

標示 (Marking) :

色碼 (Color Code) (≤ S1/2W)

文字 (Alphanumeric) (1/2W~S3W、H1W)

特性 Feature

◎使用不燃性塗料，具不燃與絕緣之安全特性(UL94 V-0)

Flameproof and insulating coating designed to assure safe usage by special non-flammable silicon-base.

(Equivalent to UL94 V-0)

◎產品符合歐盟 RoHS 要求

Products is compliance the EU-RoHS request.

產品認證 Approvals awarded

● UL 1676 & c-UL (CSA C22.2 No.1-98)File No.E220321

1/2,1,2 Watt,680K to 10M 125V : 1/2,1,2 Watt,960K to 12M 250V

● EN 60065 (VDE 0860) : 2011-10 Clause 14.1a、14.1b

Ausweis-Nr : 40030403 (1/4,1/2,1 Watt)100K to 100M

Ausweis-Nr : 40030404 (1/2,1,2 Watt)100K to 100M

● SEMKO&CB : 1/4,1/2,1,2 Watt,100K to 100M. Reference No.913033

1/4,1/2,1,2 Watt,100K to 100M

額定 Ratings

Rated Power (W)	阻值範圍 Resistance Range (Ω)			最高使用電壓 Max. Working Voltage	耐電壓 Dielectric Withstanding Voltage	溫度係數 T.C.R.	包裝 Taping/Ammo,Forming/Bulk pack (pcs)								
	F±1% (E96)	G±2% (E24)	J±5% (E24)				A26	A52	A64	FT	YT	L	C	M	D
1/6,S1/4	10Ω ~ < 100M			300V	300V	F±1%: ±100ppm/°C G±2%: ±200ppm/°C J±5%: ±200ppm/°C	5000	-	-	-	-	-	-	-	
1/4,S1/2				1600V			-	2500	-	2000	-	2500	2500	2500	2500
1/2,S1				3500V			-	2000	-	2000	2000	2500	2500	2500	2500
1,S2				7000V			-	1000	-	1000	1000	1000	1000	1000	1000
2,S3,H1				10000V			-	500	500	-	1000	1000	1000	1000	1000

結構圖 Construction



1	端子線	Lead wire	5	金屬釉皮膜	Metal glaze film
2	瓷棒	Ceramic base	6	標示	Marking or color code
3	鐵帽	Cap			
4	切割線	Helical cutting groove	7	絕緣塗料	Insulation coat

外型尺寸 Dimensions

Rated Power (W)	Dimensions (mm)					Weight (g) (1000pcs)
	L	L1 Max.	D	Ød	l	
1/6,S1/4	3.3±0.3	4	1.8±0.2	0.45±0.05	28±2	120
1/4,S1/2	6.0±0.5	7	2.4±0.3	0.6±0.05	28±2	218
1/2,S1	9±0.5	11	3.3±0.5	0.6/0.8±0.05	28±3	320
1,S2	12±1	15	4.5±0.5	0.8±0.05	38±3	780
2,S3,H1	16±1	18	5.5±0.5			1450

料號編碼 Type composition

例 Example

R	U	14	J	1005	A520	NL
型名 Type	品名 Size	額定功率 Rated Power	誤差值 Tolerance	電阻值(Ω) Resistance	二次加工 Forming	端子線 Lead Wire
	U: Standard	16:1/6W	F±1%	10R0=10	See table below	電鍍線 Electro plated
	S: Small	14:1/4W	G±2%	1000=100		
	H: Large-scale	12:1/2W	J±5%	1001=1K		
		01:1W		1002=10K		
		02:2W		1003=100K		
		03:3W		1004=1M		
				1005=10M		

■ 額定溫度下降曲線圖 Derating curve

例 Example

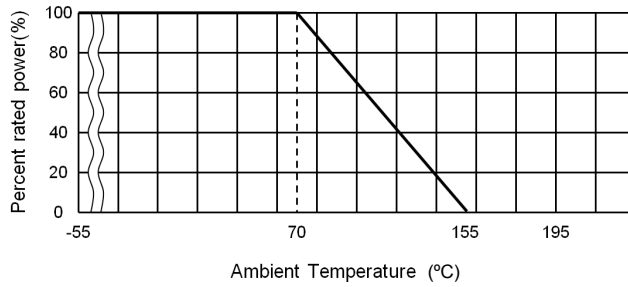

■ 二次加工對應表 Taping & Forming Matrix

Rated Power (W)	Taping			Radial Taping		L Forming				C Forming			F Forming				M Forming			D Forming			
	A26	A52	A64	FT	YT	L10	L12.5	L15	L20	C12.5	C15	C20	FA5	FB5	FC5	FD5	M12.5	M15	M20	D12.5	D15	D20	
1/6,S1/4	○	○	-	-	-	-	-	-	-	-	-	-	-	-	-	-	-	-	-	-	-	-	-
1/4,S1/2	-	○	-	○	-	○	-	-	-	-	-	-	-	-	-	-	-	-	-	-	-	-	-
1/2,S1	-	○	-	○	○	-	○	-	-	○	-	-	○	○	○	○	○	-	-	-	○	-	-
1,S2	-	○	-	○	○	-	-	○	-	-	○	-	○	○	○	○	-	○	-	-	-	○	-
2,S3,H1	-	○	○	-	○	-	-	-	○	-	-	○	○	○	○	○	-	-	○	-	-	-	○

■ 試驗條件與方法 The testing method and condition.

試驗項目 Test Items	規格值 Performance Requirements	試驗方法 Test Methods and Standard.(JISC5201-1)
電阻值 Resistance	規定的誤差值內 Within of specified tolerance	測量點從端蓋 10mm Measuring points are distance 10mm from the end cap(4.5)
溫度係數 T.C.R.	規定值內 Within of specified T.C.R.	室溫+100°C Room temperature +100°C(4.8)
短時間過負荷 Short time overload	±(1%+0.05Ω)	6.25 倍額定功率，5 秒 6.25 times the rated power for 5 seconds(4.13)
負荷壽命 Load life	±(1.5%+0.1Ω)	Rated voltage at 70°C for 1,000 hours 1.5hr ON / 0.5hr OFF Cycles(4.25.1)
耐濕負荷壽命 Load life in humidity	±(5%+0.1Ω)	10% rate power load 40°C, 95% RH for 1,000 hours 1.5h ON / 0.5h OFF cycle(4.24)
耐濕性 Moisture resistance	±(1%+0.05Ω)	40°C, 95% RH, 240 小時 40°C, 95% RH for 240 hours
溫度循環 Temperature cycle	±(1%+0.05Ω)	5 cycles for -25°C (30min) : room temp. (30min) ~ +85°C (30min) room temp. (30min)(4.19)
斷續過負荷 Intermittent overload	±(5%+0.1Ω)	Applicable more than 100Ω ; Rated voltage ×3 1s ON / 25s OFF , 10,000 cycles(4.13)
焊錫耐熱 Resistance to soldering heat	±(1%+0.05Ω)	260°C ± 5°C for 10 seconds (焊錫槽) 350°C ± 10°C for 3.5 seconds (手焊錫)(4.18)
絕緣電阻 Insulation resistance	>1,000MΩ	500V 絕緣測試 1 分鐘 500V insulation test 1min.(4.6.1)
不燃性 Flameproof	無燃燒現象 No evidence of flaming or arcing	AC voltage of 2,4,8,16,32 times the power rating for 1min. (V ≤ 4 times max. working voltage)
脈衝測試 Pulse withstanding voltage	±20% 	The following discharge cycle is repeated in the circuit of the left fig. 2.5 sec. ON 2.5 sec. OFF 50 cycles. With following DC pulse test voltage. Pulse voltage: 1/6W,S1/4W : (3KV). ≥ 1/4W < 100K:(3KV)//100 K~620K:(5KV) > 620 K:(10KV) Capacitor : UL-0.01 μF Non-UL 0.001μF

HIGH VOLTAGE PATH RESISTOR

RVU 耐突波電阻器
SURGE RESISTOR (Standard Type)

RVS 小型耐突波電阻器
SURGE RESISTOR (Small Type)

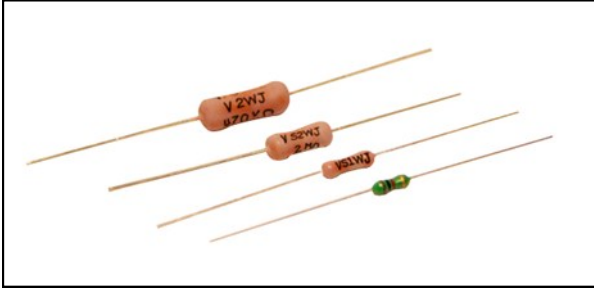

塗裝顏色(Coating Color) :

標示 (Marking)

文字 (Alphanumeric)

結構圖 Construction



1	端子線	Lead wire	5	金屬釉皮膜	Metal glaze film
2	瓷棒	Ceramic base	6	標示	Marking
3	鐵帽	Cap			
4	切割線	Helical cutting groove	7	絕緣塗料	Insulation coat

特性 Feature

◎阻值範圍：680K~3G

Resistance value range is 680K~3G.

◎長期穩定性佳

Stable and long service life.

◎可承受 10KV 突波的衝擊

Acceptable pulse of 10KV discharge.

◎溫度係數小

Small temp. coeff. of resistance.

◎產品符合歐盟 RoHS 要求

Products is compliance the EU-RoHS request.

外型尺寸 Dimensions

Rated Power (W)	Dimensions (mm)					Weight (g) (1000pcs)
	L	L1 Max.	D	Ød	l	
1/2,S1	9±0.5	11	3.3±0.5	0.6±0.05	28±3	285
1,S2	12±1	15	4.5±0.5	0.8±0.05	38±3	728
2,S3	16±1	18	5.5±0.5	0.8±0.05	38±3	1380

料號編碼 Type composition

例 Example

RV	U	12	J	1004	A520	NH
型名 Type	品名 Size	額定功率 Rated Power	誤差值 Tolerance	電阻值(Ω) Resistance	二次加工 Forming	端子線 Lead Wire
	U: Standard	12:1/2W	J±5%	1003=100K	See table	熱鍍線
	S: Small	01:1W		1004=1M	below	Heat plated
		02:2W				
		03:3W				

二次加工對應表 Taping & Forming Matrix

Rated Power (W)	Taping			Radial Taping		L Forming				C Forming			F Forming				M Forming			D Forming		
	A26	A52	A64	FT	YT	L10	L12.5	L15	L20	C12.5	C15	C20	FA5	FB5	FC5	FD5	M12.5	M15	M20	D12.5	D15	D20
1/2,S1	-	○	-	○	○	-	○	-	-	○	-	-	○	○	○	○	○	-	-	○	-	-
1,S2	-	○	○	○	○	-	-	○	-	-	○	-	○	○	○	○	-	○	-	-	○	-
2,S3	-	○	○	-	○	-	-	-	○	-	-	○	○	○	○	○	-	-	○	-	-	○

額定 Ratings

Rated Power (W)	阻值範圍 Resistance Range (Ω)		最高使用電壓 Max. Working Voltage	耐電壓 Dielectric Withstanding Voltage	溫度係數 T.C.R.	包裝 Taping/Ammo,Forming/Bulk pack (pcs)									
	J±5% (E24)					A26	A52	A64	FT	YT	L	C	M	D	
1/2,S1	680K~10M		3500V	700V	±200ppm/°C	-	2000	-	2000	2000	2500	2500	2500	2500	
1,S2			-			1000	1000	1000	1000	1000	1000	1000			
2,S3			-			500	500	1000	1000	1000	1000	1000			

■ 額定溫度下降曲線圖 Derating curve

例 Example

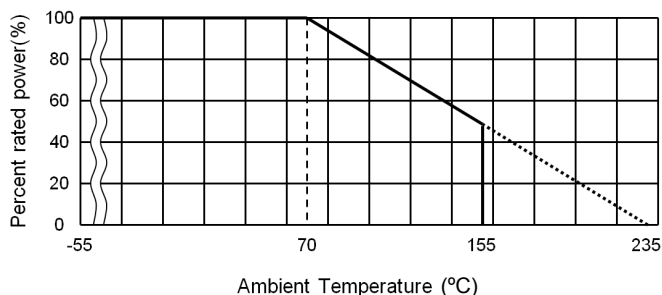

■ 試驗條件與方法 The testing method and condition.

試驗項目 Test Items	規格值 Performance Requirements	試驗方法 Test Methods and Standard.(JISC5201-1)
電阻值 Resistance	規定的誤差值內 Within of specified tolerance	測量點從端蓋 10mm Measuring points are distance 10mm from the end cap(4.5)
溫度係數 T.C.R.	規定值內 Within of specified T.C.R.	室溫+100°C Room temperature +100°C(4.8)
短時間過負荷 Short time overload	±(1%+0.05Ω)	6.25 倍額定功率，5 秒 6.25 times the rated power for 5 seconds(4.13)
負荷壽命 Load life	±(1.5%+0.1Ω)	Rated voltage at 70°C for 1,000 hours 1.5hr ON / 0.5hr OFF Cycles(4.25.1)
耐濕負荷壽命 Load life in humidity	±(5%+0.1Ω)	10% rate power load 40°C, 95% RH for 1,000 hours 1.5h ON / 0.5h OFF cycle(4.24)
耐濕性 Moisture resistance	±(1%+0.05Ω)	40°C，95% RH，240 小時 40°C, 95% RH for 240 hours
溫度循環 Temperature cycle	±(1%+0.05Ω)	5 cycles for -25°C (30min) : room temp. (30min) ~ +85°C (30min) room temp. (30min)(4.19)
焊錫耐熱 Resistance to soldering heat	±(1%+0.05Ω)	260°C ±5°C for 10 seconds (焊錫槽) 350°C ±10°C for 3.5 seconds (手焊錫)
絕緣電阻 Insulation resistance	≥ 50GΩ	500V 絕緣測試 1 分鐘 500V insulation test 1min.(4.6.1)
UL 脈衝測試 UL Pulse withstanding voltage	±20%	 <p>The following discharge cycle is repeated in the circuit of the left fig. 2.5 sec. ON 2.5 sec. OFF 50 cycles. Test voltage (DC surge) 10KV(Max)</p>
台灣雙羽脈衝試驗 Futaba Pulse withstanding voltage	±3%	 <p>The following discharge cycle is repeated in the circuit of the left fig. 1 sec. ON 1 sec. OFF 50 cycles. Test voltage (DC surge) is shown below: Pulse voltage : 14KV(Max)</p>

耐突波測試 Surge Test

High Energy Test 高能量測試		Low Energy Test 低能量測試	
ITEM 項目	SPEC. 規格	ITEM 項目	SPEC. 規格
Capacitance 電容值 (µF)	0.12µF	Capacitance 電容值 (µF)	0.03µF
Voltage 電壓 (KV)	10KV	Voltage 電壓 (KV)	10KV
Charging/Discharge Time 充/放電時間	10sec / 2sec	Charging/Discharge Time 充/放電時間	10sec / 2sec
Cycle 週期	12sec	Cycle 週期	12sec
Charging/Discharge Cycles 充/放電次數	1,000 Cycles	Charging/Discharge Cycles 充/放電次數	10,000 Cycles
Criteria 判定標準	+ 100% ~ -20%	Criteria 判定標準	+ 100% ~ -10%

HIGH VOLTAGE PATH RESISTOR

RRU 高阻值金屬釉電阻器
HIGH RESISTANCE RESISTOR (Standard Type)

RRS 高阻值小型金屬釉電阻器
HIGH RESISTANCE RESISTOR (Small Type)



結構圖 Construction



1	端子線	Lead wire	5	金屬釉皮膜	Metal glaze film
2	瓷棒	Ceramic base	6	標示	Marking or color code
3	鐵帽	Cap			
4	切割線	Helical cutting groove	7	絕緣塗料	Insulation coat

塗裝顏色(Coating Color) :
RRU1/6W、RRU1/4W 深藍色 Dark blue 粉紅色 other pink

標示 (Marking) :

色碼 (Color Code) ≤ S1/2W

文字 (Alphanumeric) 1/2W~S3W

外型尺寸 Dimensions

Rated Power (W)	Dimensions (mm)					Weight (g) (1000pcs)
	L	L1 Max.	D	Ød	ℓ	
1/6,S1/4	3.3±0.3	4	1.8±0.2	0.45±0.05	28±2	120
1/4,S1/2	6.0±0.3	7	2.4±0.1	0.6±0.05	28±2	218
1/2,S1	9±0.5	11	3.3±0.5		28±3	320
1,S2	12±1	15	4.5±0.5	0.8±0.05	38±3	780
2,S3	16±1	18	5.5±0.5			1450
5W,S7W	24±1	26	8±10.5			3800

特性 Feature

- ◎阻值範圍 101MΩ~3GΩ
Resistance value range is 101MΩ~3GΩ.
- ◎溫度係數可低至 50ppm 一般為 200ppm
Low T.C.R.to 50ppm. Normal is 200ppm.
- ◎長期穩定性與長效使用壽命
Long load life and long term stability.
- ◎產品符合歐盟 RoHS 要求
Products is compliance the EU-RoHS request.

料號編碼 Type composition

例 Example

RR	U	14	J	10R0	A520	NH
型名 Type	品名 Size	額定功率 Rated Power	誤差值 Tolerance	電阻值(Ω) Resistance	二次加工 Forming	端子線 Lead Wire
	U: Standard	16:1/6W	F±1%	1006=100M	See table	熱鍍線
	S: Small	14:1/4W	G±2%	1007=1G	below	Heat plated
		12:1/2W	J±5%			
		01:1W				
		02:2W				
		03:3W				
		05:5W				
		07:7W				

參考規格 Reference standards

- JIS C 5201-1

額定 Ratings

Rated Power (W)	阻值範圍 Resistance Range (Ω) J±5% (E24)	最高使用電壓 Max. Working Voltage	耐電壓 Dielectric Withstanding Voltage	溫度係數 T.C.R.	包裝 Taping/Ammo,Forming/Bulk pack (pcs)									
					A26	A52	A64	FT	YT	L	C	M	D	
1/6,S1/4	≥ 100M~3G	500V	700V	±200ppm/°C (±50ppm/°C is contact salse)	5000	-	-	-	-	-	-	-	-	-
1/4,S1/2		1600V			-	2500	-	2000	-	2500	2500	2500	2500	
1/2,S1		3500V			-	2000	-	2000	2000	1000	2500	2500	2500	
1,S2		7000V			-	1000	1000	1000	1000	1000	1000	1000	1000	
2,S3		10000V			-	500	500	-	1000	1000	1000	1000	1000	
5W,S7W		15000V			-	-	-	-	-	500	500	500	500	

■ 額定溫度下降曲線圖 Derating curve

例 Example



■ 試驗條件與方法 The testing method and condition.

試驗項目 Test Items	規格值 Performance Requirements	試驗方法 Test Methods and Standard.(JISC5201-1)
電阻值 Resistance	規定的誤差值內 Within of specified tolerance	測量點從端蓋 10mm Measuring points are distance 10mm from the end cap(4.5)
溫度係數 T.C.R.	規定值內 Within of specified T.C.R.	室溫+100°C Room temperature +100°C(4.8)
短時間過負荷 Short time overload	±(1%+0.05Ω)	6.25 倍額定功率，5 秒 6.25 times the rated power for 5 seconds(4.13)
負荷壽命 Load life	±(1.5%+0.1Ω)	Rated voltage at 70°C for 1,000 hours 1.5hr ON / 0.5hr OFF Cycles(4.25.1)
耐濕負荷壽命 Load life in humidity	±(5%+0.1Ω)	10% rate power load 40°C, 95% RH for 1,000 hours 1.5h ON / 0.5h OFF cycle(4.24)
耐濕性 Moisture resistance	±(1%+0.05Ω)	40°C, 95% RH, 240 小時 40°C, 95% RH for 240 hours
溫度循環 Temperature cycle	±(1.5%+0.05Ω)	5 cycles for -25°C (30min) : room temp. (30min) ~ +85°C (30min) room temp. (30min)(4.19)
焊錫耐熱 Resistance to soldering heat	±(1%+0.05Ω)	260°C ±5°C for 10 seconds (焊錫槽) 350°C ±10°C for 3.5 seconds (手焊錫)
絕緣電阻 Insulation resistance	□50GΩ	500V 絕緣測試 1 分鐘 500V insulation test 1min.(4.6.1)
UL 脈衝測試 UL Pulse withstanding voltage	±20% 	The following discharge cycle is repeated in the circuit of the left fig. 2.5 sec. ON 2.5 sec. OFF 50 cycles. Pulse test voltage (DC surge) 10KV.

FUSING RESISTOR

RFU 保險絲電阻器
FUSIBLE RESISTOR (Standard Type)

RFS 小型保險絲電阻器
FUSIBLE RESISTOR (Small Type)



塗料顏色 (Coating Color) :

標準品 (Standard Type) 灰 Gray

小型品 (Small Type) 粉紅 Pink

標示 (Marking) :

色環 (Color Code) 1/6W、1/4W、1/3W、S1/2W

文字 (Alphanumeric) 1/2W~S3W

特性 Feature

◎使用不燃性塗料,具不燃與絕緣之安全特性(UL94 V-0)

Flameproof and insulating coating designed to assure safe usage by special non-flammable silicon-base.

(Equivalent to UL94 V-0)

◎正常情況下具電阻功能

Function as a resistor in normal operation.

◎異常過負荷時可快速熔斷

Quick fusing protects circuit from excessive overload.

◎產品符合歐盟 RoHS 要求

Products is compliance the EU-RoHS request.

參考規格 Reference standards

● JIS C 5201-1

二次加工對應表 Taping & Forming Matrix

Rated Power (W)	Taping			Radial Taping		L Forming					C Forming				F Forming				M Forming			D Forming			
	A52	A64	A73	FT	YT	L10	L12.5	L15	L20	L30	C12.5	C15	C20	C30	FA5	FB5	FC5	FD5	M12.5	M15	M20	D12.5	D15	D20	
1/6,S1/4	○	-	-	-	-	-	-	-	-	-	-	-	-	-	-	-	-	-	-	-	-	-	-	-	-
1/4,S1/2,1/3	○	-	-	○	-	○	-	-	-	-	-	-	-	-	-	-	-	-	-	-	-	-	-	-	-
1/2,S1,P2	○	-	-	○	○	-	○	-	-	-	○	-	-	-	○	○	○	○	○	-	-	-	○	-	-
1,S2	○	○	-	○	○	-	-	○	-	-	-	○	-	-	○	○	○	○	-	○	-	-	-	○	-
2,S3	-	○	-	-	○	-	-	-	○	-	-	○	-	-	○	○	○	○	-	-	○	-	-	-	○

額定 Ratings

Rated Power (W)	阻值範圍 Resistance Range (Ω)	最高使用電壓 Max. Working Voltage	最高過負荷電壓 Max. Overload Voltage	耐電壓 Dielectric Withstanding Voltage	溫度係數 T.C.R.	包裝 Taping/Ammo,Forming/Bulk pack (pcs)					
	J±5% (E24)					A52	A64	FT	YT	L	C
1/6,S1/4	0.1~1K	100V	150V	200V	±350ppm/°C	5000	-	-	-	-	-
1/4,1/3	0.1~15K	250V	300V	250V		2500	-	2000	2000	2500	2500
S1/2,S1,P2	0.1~33K	250V	300V	250V		2500	-	1000	1000	2500	2500
1/2	0.1~4.7K	250V	300V	300V		2000	-	1000	1000	2500	2500
1,2,S2,S3		350V	500V	300V		1000	500	1000	1000	1000	1000

結構圖 Construction

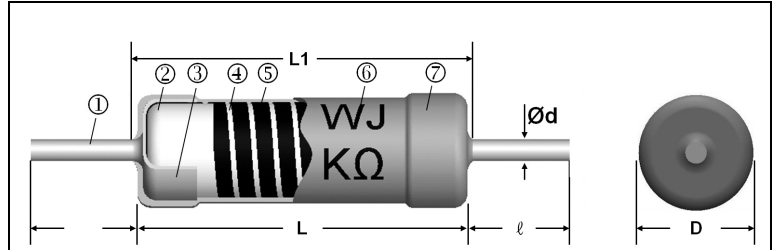

1	端子線	Lead wire	5	保險型皮膜	Fusible film
2	瓷棒	Ceramic base	6	標示	Marking or color code
3	鐵帽	Cap			
4	切割線	Helical cutting groove	7	絕緣塗料	Insulation coat

外型尺寸 Dimensions

Rated Power (W)	Dimensions (mm)					Weight (g) (1000pcs)
	L	L1 Max.	D	Ød	l	
1/6,S1/4	3.3±0.3	4	1.7±0.3	0.45±0.05	27±3	120
1/4,1/3,S1/2	6.0±0.3	7	2.4±0.1	0.6±0.05	28±2	218
1/2,S1,P2	9±0.5	11	3.0±0.5		28±3	320
1,S2	12±1	15	4.5±0.5	0.8±0.05	38±3	780
2,S3	16±1	18	5.5±0.5			1450

料號編碼 Type composition

例 Example

RF	U	14	J	R100	A520	NH
型名 Type	品名 Size	額定功率 Rated Power	誤差值 Tolerance	電阻值(Ω) Resistance	二次加工 Forming	端子線 Lead Wire
	U: Standard	16:1/6W	J±5%	1006=100M	See table	熱鍍線
	S: Small	14:1/4W		1007=1G	below	Heat plated
		12:1/2W				
		01:1W				
		02:2W				

■ 額定溫度下降曲線圖 Derating curve

例 Example

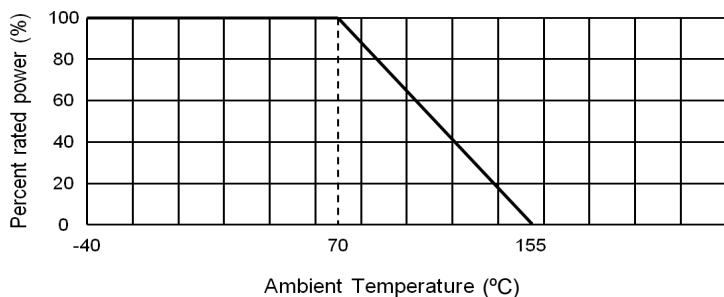

■ 熔斷特性 Fusing characteristics

殘留阻值為公稱阻值 100 倍以上 (Residual resistance \geq 100 times nominal resistance)

Rated Power (W)	Resistance Range	$\sqrt{40PR}$	$\sqrt{30PR}$	$\sqrt{25PR}$	$\sqrt{16PR}$	Fusing Time
1/6、S1/4	0.10 ~ 1K Ω	0.10 ~ 0.18 Ω	0.20 ~ 0.47 Ω	0.51 ~ 1K Ω	-----	60 Sec Max
1/4、1/3	0.10 ~ 15K Ω	0.10 ~ 0.22 Ω	-----	0.24 ~ 9.1 Ω	10 ~ 15K Ω	
S1/2、P2	0.10 ~ 33K Ω	-----	-----	0.10 ~ 1.0 Ω	1.1 ~ 33K Ω	
S1、P2	0.10 ~ 33K Ω	-----	-----	0.10 ~ 1.0 Ω	1.1 ~ 33K Ω	
1/2	0.10 ~ 4.7K Ω	0.10 ~ 0.33 Ω	0.47 ~ 0.91 Ω	1.0 ~ 9.1 Ω	10 ~ 4.7K Ω	
1、S2	0.10 ~ 4.7K Ω	-----	-----	0.10 ~ 1.0 Ω	1.1 ~ 4.7K Ω	
2、S3	0.10 ~ 4.7K Ω	-----	-----	0.10 ~ 1.0 Ω	1.1 ~ 4.7K Ω	

■ 試驗條件與方法 The testing method and condition.

試驗項目 Test Items	規格值 Performance Requirements	試驗方法 Test Methods and Standard.(JISC5201-1)
電阻值 Resistance	規定的誤差值內 Within of specified tolerance	測量點從端蓋 10mm Measuring points are distance 10mm from the end cap(4.5)
溫度係數 T.C.R.	規定值內 Within of specified T.C.R.	室溫+100°C Room temperature +100°C(4.8)
短時間過負荷 Short time overload	$\pm(2\%+0.05\Omega)$	4 倍額定功率，5 秒 4 times the rated power for 5 seconds
負荷壽命 Load life	$\pm(5\%+0.1\Omega)$	Rated voltage at 70°C for 1,000 hours 1.5hr ON / 0.5hr OFF Cycles(4.25.1)
耐濕負荷壽命 Load life in humidity	$\pm(5\%+0.1\Omega)$	10% rate power load 40°C, 95% RH for 1,000 hours 1.5h ON / 0.5h OFF cycle(4.24)
耐濕性 Moisture resistance	$\pm(1\%+0.05\Omega)$	40°C，95% RH，240 小時 40°C, 95% RH for 240 hours
溫度循環 Temperature cycle	$\pm(1\%+0.05\Omega)$	5 cycles for -25°C (30min) : room temp. (30min) ~ +85°C (30min) room temp. (30min)(4.19)
焊錫效果 Soldeability	95 % (min) coverage	Temp. of solder 245°C \pm 5°C duration of immersion 3s \pm 0.5s
焊錫耐熱 Resistance to soldering heat	$\pm(1\%+0.05\Omega)$	260°C \pm 5°C for 10 seconds (焊錫槽) 350°C \pm 10°C for 3.5 seconds (手焊錫)(4.18)
絕緣電阻 Insulation resistance	>1,000M Ω	500V 絕緣測試 1 分鐘 500V insulation test 1min.(4.6.1)

RATED CURRENT FUSIBLE RESISTOR

RFA

電流式保險絲電阻器

RATED CURRENT FUSIBLE RESISTOR (Standard Type)



塗料顏色 (Coating Color) :
標準品 (Standard Type) Gray
標示 (Color Code)

結構圖 Construction

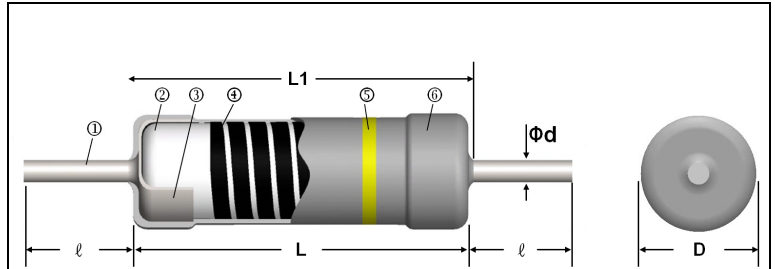

1	端子線	Lead wire	5	保險型皮膜	Fusible film
2	瓷棒	Ceramic base	6	標示	color code
3	鐵帽	Cap	7	絕緣塗料	Insulation coat
4	切割線	Helical cutting groove			

特性 Feature

◎使用不燃性塗料,具不燃與絕緣之安全特性(UL94 V-0)
Flameproof and insulating coating designed to assure safe usage by special non-flammable silicon-base.
(Equivalent to UL94 V-0)

◎電流式保險絲提供電阻器熔斷遲延的性能及在定電流作業下的高穩定性
The rated current fusible resistor combines time delay performance Characteristics with the proven reliability of a rated current fusible.

◎產品符合歐盟 RoHS 要求
Products is compliance the EU-RoHS request.

外型尺寸 Dimensions

Rated Current (A)	Dimensions (mm)					Weight (g) (1000pcs)
	L	L1 Max.	D	Ød	l	
≤ 3A	6.0±0.3	7	2.4±0.1	0.6±0.05	28±2	218
> 3A	9±0.5	11	3.0±0.5		28±3	320

料號編碼 Type composition

例 Example

RF	A	00	J	A100	A520	NH
型名 Type	品名 Size	空欄 Blank	誤差值 Tolerance	電阻值(Ω) Resistance	二次加工 Forming	端子線 Lead Wire
		無註記	F±1% G±2% J±5%	A100=0.1A 1A50=1.5A 3A00=3A 7A00=7A	See table below	熱鍍線 Heat plated

參考規格 Reference standards

● JIS C 5201-1

二次加工對應表 Taping & Forming Matrix

Rated Current (A)	Taping			Radial Taping		L Forming					C Forming				F Forming				M Forming			D Forming		
	A52	A64	A73	FT	YT	L10	L12.5	L15	L20	L30	C12.5	C15	C20	C30	FA5	FB5	FC5	FD5	M12.5	M15	M20	D12.5	D15	D20
≤ 3A	○	-	-	○	-	○	-	-	-	-	-	-	-	-	-	-	-	-	○	-	-	○	-	-
> 3A	○	-	-	○	○	-	○	-	-	-	○	-	-	-	○	○	○	○	-	○	-	-	○	-

額定 Ratings

Rated Current (A)	耐電壓 Dielectric Withstanding Voltage	溫度係數 T.C.R.	包裝 Taping/Ammo, Forming/Bulk pack(pcs)						
			A52	A64	FT	YT	L	C	
≤ 3A	100V	±350ppm/°C	2500	-	2000	2000	2500	2500	
> 3A			2000	-	1000	1000	2500	2500	

熔斷特性 Fusing characteristics

額定電流% Percentage of Ampere Rating	熔斷時間 Opening Time
100%	4Hours Min
200%	1 second~60second Max
300%	0.2 second~3 second Max
800%	0.02 second~0.2 second Max

殘留阻值為公稱阻值 100 倍以上(Residual resistance ≥ 100 times nominal resistance)

額定電流電阻表面溫度曲線

Curve of temp. rise and rated current



■ 額定溫度下降曲線圖 Derating curve

例 Example

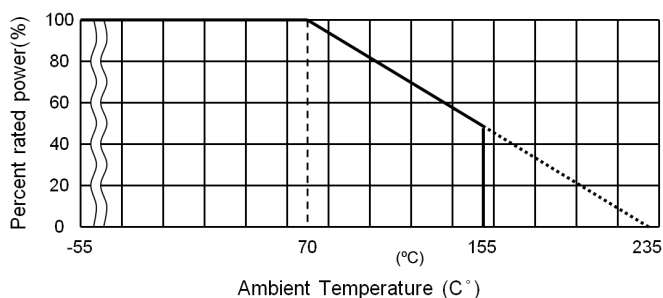

■ 定電流熔斷曲線 Fuse curve of rated current



■ 訂購資訊 Ordering information

Order	Amperes	Voltage	Body	Melting
A250	1/4	125	25*65	0.125
A375	3/8	125	25*65	0.28
A500	1/2	125	25*65	0.50
A750	3/4	125	25*65	1.12
1A00	1.00	125	25*65	2.00
1A50	1.1/2	125	25*65	5.50
2A00	2.00	125	25*65	8.00
2A25	2.1/4	125	25*65	10.12
2A50	2.1/2	125	25*65	12.50
3A00	3.00	125	25*65	18.0
3A15	3.15	125	25*65	20.0
4A00	4.00	125	28*92	32.0
5A00	5.00	125	28*92	50.0
7A00	7.00	125	28*92	98.0

■ 試驗條件與方法 The testing method and condition.

試驗項目 Test Items	規格值 Performance Requirements	試驗方法 Test Methods and Standard.(JISC5201-1)
電阻值 Resistance	規定的誤差值內 Within of specified tolerance	測量點從端蓋 10mm Measuring points are distance 10mm from the end cap(4.5)
溫度係數 T.C.R.	規定值內 Within of specified T.C.R.	室溫+100°C Room temperature +100°C(4.8)
短時間過負荷 Short time overload	±(2%+0.05Ω)	4 倍額定功率，5 秒 4 times the rated power for 5 seconds
負荷壽命 Load life	±(5%+0.1Ω)	Rated voltage at 70°C for 1,000 hours 1.5hr ON / 0.5hr OFF Cycles(4.25.1)
耐濕負荷壽命 Load life in humidity	±(5%+0.1Ω)	10% rate power load 40°C, 95% RH for 1,000 hours 1.5h ON / 0.5h OFF cycle(4.24)
耐濕性 Moisture resistance	±(1%+0.05Ω)	40°C，95% RH，240 小時 40°C, 95% RH for 240 hours
溫度循環 Temperature cycle	±(1%+0.05Ω)	5 cycles for -25°C (30min) ; room temp. (30min) ~ +85°C (30min) room temp. (30min)(4.19)
焊錫效果 Soldeability	95 % (min) coverage	Temp. of solder 245°C ± 5°C duration of immersion 3s±0.5s
焊錫耐熱 Resistance to soldering heat	±(1%+0.05Ω)	260°C ±5°C for 10 seconds (焊錫槽) 350°C±10°C for 3.5 seconds (手焊錫)
絕緣電阻 Insulation resistance	>1,000MΩ	500V 絕緣測試 1 分鐘 500V insulation test 1min.(4.6.1)
不燃性 Flameproof	無燃燒現象 No evidence of flaming or arcing	AC voltage of 2,4,8,16,32 times the power rating for 1min. (V ≤ 4 times max. working voltage)

FUSING RESISTOR

WFU 高能量突波繞線保險絲電阻器
FUSIBLE RESISTOR (Standard Type)

WFS 小型高能量突波繞線保險絲電阻器
HEAT ENERGY SURGE WIRE WOUND FUSIBLE RESISTOR (Small Type)

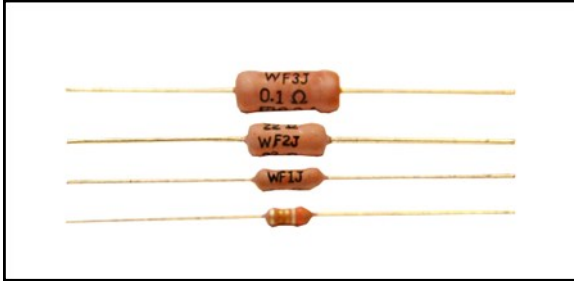

塗料顏色 (Coating Color):

標準品 (Standard Type) Gray

小型品 (Small Type) Pink

標示 (Marking):

色碼 (Color Code) S1/2W

文字 (Alphanumeric) 1/2W~S3W

特性 Feature

◎電壓式繞線保險絲提供高突波能量的特性，準確的熔

斷性能，及在額定功率下作業的高穩定性

The voltage type wire wound fusible resistor can provide reliable fusing behavior stable performance and endurance to surge voltage.

◎產品符合歐盟 RoHS 要求

Products is compliance the EU-RoHS request.

參考規格 Reference standards

● JIS C 5201-1

結構圖 Construction

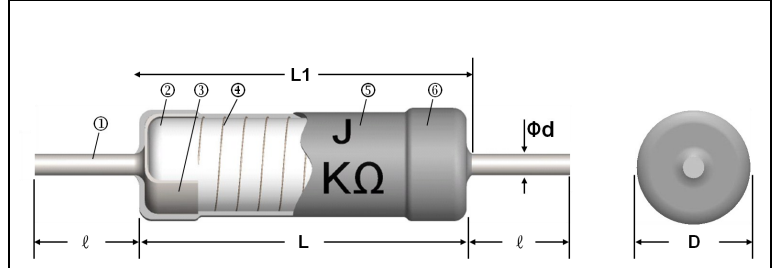

1	端子線	Lead wire	4	繞線	Wire wound
2	瓷棒	Ceramic base	5	標示	Marking or color code
3	鐵帽	Cap	6	絕緣塗料	Insulation coat

外型尺寸 Dimensions

Rated Power (W)	Dimensions (mm)					Weight (g) (1000pcs)
	L	L1 Max.	D	Ød	ℓ	
S1/2	6.0±0.3	7	2.4±0.1	0.6±0.05	28±3	200
1/2,S1	9.0±0.5	11	3.0±0.5			285
1,S2	12±1	15	4.5±0.5	0.8±0.05	38±3	728
2,S3	16±1	18	5.5±0.5			1380

料號編碼 Type composition

例 Example

WF	U	12	J	R100	A520	NH
型名 Type	品名 Size	額定功率 Rated Power	誤差值 Tolerance	電阻值(Ω) Resistance	二次加工 Forming	端子線 Lead Wire
	U: Standard	12:1/2W	J±5%	R100=0.1	See table	熱鍍線 Heat plated
	S: Small	01:1W		1R00=1		
		02:2W		10R0=10		
		03:3W		1000=100		

二次加工對應表 Taping & Forming Matrix

Rated Power (W)	Taping			Radial Taping		L Forming					C Forming				F Forming				M Forming			D Forming			
	A52	A64	A73	FT	YT	L10	L12.5	L15	L20	L30	C12.5	C15	C20	C30	FA5	FB5	FC5	FD5	M12.5	M15	M20	D12.5	D15	D20	
S1/2	○	-	-	○	-	○	-	-	-	-	-	-	-	-	○	○	○	○	-	-	-	-	-	-	-
1/2,S1	○	-	-	○	○	-	○	-	-	-	○	-	-	-	○	○	○	○	○	-	-	-	○	-	-
1,S2	○	○	-	○	○	-	-	○	-	-	-	○	-	-	○	○	○	○	-	○	-	-	○	-	-
2,S3	-	○	-	-	○	-	-	-	○	-	-	-	○	-	○	○	○	○	-	-	○	-	-	-	○

額定 Ratings

Rated Power (W)	阻值範圍 Resistance Range (Ω)		最高使用電壓 Max. Working Voltage	最高過負荷電壓 Max. Overload Voltage	耐電壓 Dielectric Withstanding Voltage	溫度係數 T.C.R.	包裝 Taping/Ammo,Forming/Bulk pack (pcs)					
	J±5% (E24)						A52	A64	FT	YT	L	C
S1/2	0.1 ~ 150		100V	150V	100V	≤ 1Ω : ± 500ppm/°C > 1Ω : ± 300ppm/°C	2500	-	2000	2000	2500	2500
1/2,S1							2000	-	1000	2000	2500	2500
1,S2							1000	1000	1000	1000	1000	1000
2,S3							500	500	1000	1000	1000	1000

■ 額定溫度下降曲線圖 Derating curve

例 Example

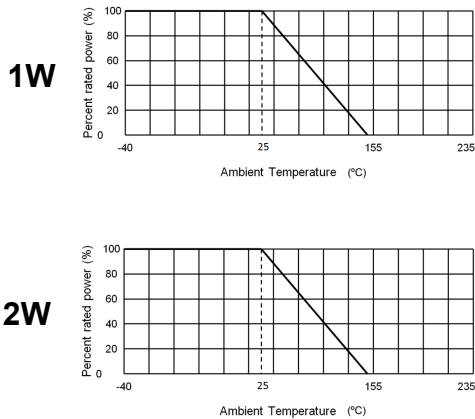

■ 突波特性

例 Example



■ 額定功率表面溫升

Surface Temperature Rise
Vs. Loaded Power

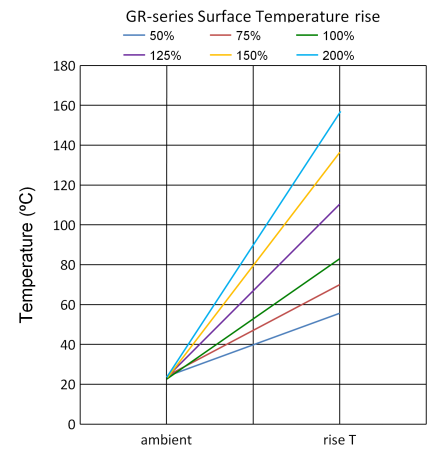

■ 熔斷特性 Fusing characteristics

殘留阻值為公稱阻值 100 倍以上 (Residual resistance \geq 100 times nominal resistance)

Power Rating I=constant	Opening Time	1/2W & S1W	Power Rating I=constant	Opening Time	1W & S2W & P3W	Power Rating I=constant	Opening Time	2W & S3W
16W	10 sec Min		24W	10 sec Min		23W	10 sec Min	
18W	3sec ~ 60 sec Max	28W	8sec ~ 45 sec Max	40W	10sec ~ 30 sec Max			
20W	2 sec ~ 30 sec Max	32W	5 sec ~ 30 sec Max	48W	3 sec ~ 8 sec Max			
22W	1sec ~ 15sec Max	36W	2sec ~ 15sec Max	60W	2sec ~ 5sec Max			

■ 試驗條件與方法 The testing method and condition.

試驗項目 Test Items	規格值 Performance Requirements	試驗方法 Test Methods and Standard.(JISC5201-1)
電阻值 Resistance	規定的誤差值內 Within of specified tolerance	測量點從端蓋 10mm Measuring points are distance 10mm from the end cap(4.5)
溫度係數 T.C.R.	規定值內 Within of specified T.C.R.	室溫+100°C Room temperature +100°C(4.8)
短時間過負荷 Short time overload	$\pm(1\%+0.05\Omega)$	4 倍額定功率，5 秒 4 times the rated power for 5 seconds
負荷壽命 Load life	$\pm(5\%+0.1\Omega)$	Rated voltage at 70°C for 1,000 hours 1.5hr ON / 0.5hr OFF Cycles(4.25.1)
耐濕負荷壽命 Load life in humidity	$\pm(5\%+0.1\Omega)$	10% rate power load 40°C, 95% RH for 1,000 hours 1.5h ON / 0.5h OFF cycle(4.24)
耐濕性 Moisture resistance	$\pm(1\%+0.05\Omega)$	40°C, 95% RH, 240 小時 40°C, 95% RH for 240 hours
溫度循環 Temperature cycle	$\pm(1\%+0.05\Omega)$	5 cycles for -25°C (30min) : room temp. (30min) ~ +85°C (30min) room temp. (30min)(4.19)
焊錫效果 Soldeability	95 % (min) coverage	Temp. of solder 245°C \pm 5°C duration of immersion 5s \pm 0.5s
絕緣電阻 Insulation resistance	>1,000M Ω	500V 絕緣測試 1 分鐘 500V insulation test 1min.(4.6.1)
不燃性 Flameproof	無燃燒現象 No evidence of flaming or arcing	AC voltage of 2,4,8,16,32 times the power rating for 1min. ($V \leq$ 4 times max. working voltage)

NON-SMOKE THERMAL FUSE RESISTOR

RFT 水泥繞線電阻組合溫度保險絲電阻器 NON-SMOKE THERMAL FUSE RESISTOR (RFT Type)



本體顏色 (Body color) :
白色 (White)
標示 (Marking) :
文字 (Alphanumeric)

特性 Feature

◎不燃與絕緣之安全設計

Compact type with safety design of Non-flammability and insulation.

◎可依客戶需求製作

Can be produced according to customer's request.

◎產品符合歐盟 RoHS 要求

Products is compliance the EU-RoHS request.

產品認證 Approvals awarded

● UL 1412 File No.E257690 CUL

UL1412 Recognized : $\leq 145^{\circ}\text{C}$ / 3W、5W、7W、10W /
0.1 Ω ~ 1K Ω

參考規格 Reference standards

● JIS C 5201-1

結構圖 Construction

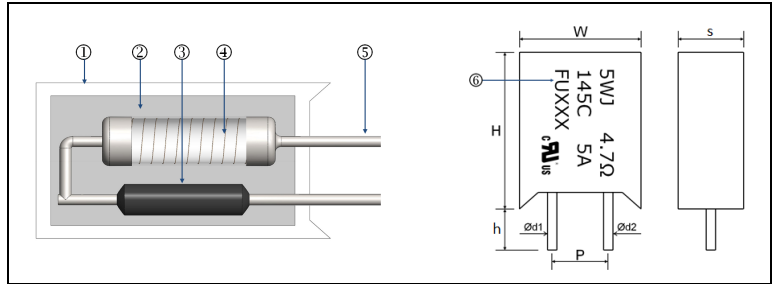

1	瓷殼	Ceramic case	4	電阻器	Resistor
2	矽水泥	Silicon cement	5	端子線	Lead wire
3	溫度保險絲	Thermal fuse	6	標示	Marking

外型尺寸 Dimensions

Rated Power (W)	Dimensions (mm)						
	H±1	W±1	h±1	P±1	s±1	Fuse: Ød1	Wire: Ød2
2	20	12	5	5	7	0.6 ±0.1	0.8 ±0.1
3	25	12	5	5	9	1.0 ±0.1	0.8 ±0.1
5	25	13.5	5	5	9	1.0 ±0.1	0.8 ±0.1
7	39	13	5	5	9	1.0 ±0.1	0.8 ±0.1
10	25	20	5	12	9	0.8 ±0.1	0.8 ±0.1
10s	35	16	5	7	12	1.0 ±0.1	0.8 ±0.1

料號編碼 Type composition

例 Example

RF	T	03	J	10R0	T133	NH
型名 Type	品名 Size	額定功率 Rated Power	誤差值 Tolerance	電阻值(Ω) Resistance	溫度 Temperature	端子線 Lead Wire
	溫度型 Thermal	03:3W 05:5W 07:7W A0:10W	F±1% G±2% J±5% K±10%	1R00=1 10R0=10 1000=100	T133 : 133°C	熱鍍線 Heat plated

額定 Ratings

Thermal Fuse			Power Rating (W)				耐電壓 Dielectric Withstanding Voltage	溫度係數 T.C.R.
Temperature Function Tf	Thermal Fuse Temp.	Voltage Rating	3W	5W	7W	10W、10WS		
65	61±3	AC 250V	0.3	0.4	0.6	0.7	1000V	± 350ppm/°C
76	72±3		0.5	0.6	0.8	1		
86	81±2		0.6	0.8	1	1.3		
102	98±3		0.9	1.1	1.4	1.7		
115	111±2		1.1	1.4	1.7	2.1		
127	123±2		1.3	1.7	2	2.5		
133	129±3		1.5	2	2.4	3		
136	131±2		1.6	2.1	2.6	3.2		
139	134±2		1.7	2.2	2.7	3.3		
145	140±2		1.8	2.3	2.8	3.5		
187	182±2		1.8	2.3	3.3	4.6		
192	187±2		1.8	2.3	3.3	4.6		
219	215±2		1.8	2.3	3.3	4.6		

■ 額定溫度下降曲線圖 Derating curve

例 Example



試驗條件與方法 The testing method and condition.

試驗項目 Test Items	規格值 Performance Requirements	試驗方法 Test Methods and Standard.(JISC5201-1)
電阻值 Resistance	規定的誤差值內 Within of specified tolerance	測量點從端蓋 10mm Measuring points are distance 10mm from the end cap(4.5)
溫度係數 T.C.R.	規定值內 Within of specified T.C.R.	試驗溫度 70°C，30 分鐘 70°C (30min)
短時間過負荷 Short time overload	$\pm(2\%+0.05\Omega)$	$\sqrt{4PR}$ 倍額定功率，5 秒 $\sqrt{4PR}$ times the rated power for 5 seconds
負荷壽命 Load life	$\pm(5\%+0.1\Omega)$	Rated voltage at 70°C for 1,000 hours 1.5hr ON / 0.5hr OFF Cycles(4.25.1)
耐濕負荷壽命 Load life in humidity	$\pm(5\%+0.1\Omega)$	10% rate power load 40°C, 95% RH for 1,000 hours 1.5h ON / 0.5h OFF cycle(4.24)
耐濕性 Moisture resistance	$\pm(2\%+0.05\Omega)$	40°C，95% RH，240 小時 40°C, 95% RH for 240 hours
溫度循環 Temperature cycle	$\pm(1\%+0.05\Omega)$	5 cycles for -25°C (30min) : room temp. (30min) ~ +85°C (30min) room temp. (30min)(4.19)
焊錫耐熱 Resistance to soldering heat	$\pm(1\%+0.05\Omega)$	260°C \pm 5°C for 10 seconds (焊錫槽) 350°C \pm 10°C for 3.5 seconds (手焊錫)(4.18)
絕緣電阻 Insulation resistance	>1,000M Ω	500V 絕緣測試 1 分鐘 500V insulation test 1min.(4.6.1)

FUSING RESISTOR

RFB 防爆保險絲電阻器
ANTI-BURST FUSIBLE RESISTOR (Wire Type)

RFF 防爆保險絲電阻器
ANTI-BURST FUSIBLE RESISTOR (Film Type)



本體顏色 (Body Color) :
白色 (White)
標示 (Marking) :
色碼 (Color Code) (1/4W)
文字 (Alphanumeric) (1/2W~3W)

結構圖 Construction



1	端子線	Lead wire	5	標示	Marking
2	鐵帽	Cap	6	瓷管	Ceramic tube
3	瓷棒	Ceramic base			
4	繞線	Wire wound	7	絕緣塗料	Insulation coat

特性 Feature

◎ 防爆式繞線保險絲或防爆式皮膜保險絲

The ANTI-BURST Type wire wound or film type fusible.

◎ 提供無爆裂與保護環境的安全熔斷特性，準確的熔斷性能

Resistors can provide reliable and environmentally safe fusing behavior.

◎ 在額定功率下作業的持久高穩定性

Reliable performance and endurance to surge voltage.

◎ 產品符合歐盟 RoHS 要求

Products is compliance the EU-RoHS request.

外型尺寸 Dimensions

Rated Power (W)	Dimensions (mm)					Weight (g) (1000pcs)
	L	L1 Max.	D	Ød	ℓ	
1/4	6.6±0.5	10	3.6±0.5	0.6±0.05	26±2	310
1/2	11±1	14	4.3±0.5			490
1	11±1	14	4.3±0.5			490
2	13±1	16	5.5±0.5	0.8±0.05	30±3	1250
3	17±1	20	7.0±0.5			35±3

料號編碼 Type composition

例 Example

RF	B	14	J	R100	A520	NH
型名 Type	品名 Size	額定功率 Rated Power	誤差值 Tolerance	電阻值(Ω) Resistance	二次加工 Forming	端子線 Lead Wire
	B: Wire	14:1/4W	J±5%	R100=0.1	See table below	熱鍍線 Heat plated
	F: Film	12:1/2W		1R00=1		
		01:1W		10R0=10		
		02:2W		1000=100		
		03:3W				

產品認證 Approvals awarded

● UL 1412 File No.E257690

參考規格 Reference standards

● JIS C 5201-1

二次加工對應表 Taping & Forming Matrix

Rated Power (W)	Taping			Radial Taping		L Forming					C Forming			F Forming				M Forming			D Forming				
	A52	A64	A73	FT	YT	L10	L12.5	L15	L20	L30	C12.5	C15	C20	C30	FA5	FB5	FC5	FD5	M12.5	M15	M20	D12.5	D15	D20	
1/4	○	-	-	-	-	-	-	-	-	-	-	-	-	-	-	-	-	-	-	-	-	-	-	-	-
1/2,1	○	-	-	-	-	-	-	○	-	-	-	○	-	-	○	○	○	○	-	○	-	-	○	-	-
2	-	○	-	-	-	-	-	-	○	-	-	○	-	-	○	○	○	○	-	-	○	-	-	-	○
3	-	-	-	-	-	-	-	-	-	-	-	-	-	-	-	-	-	-	-	-	-	-	-	-	-

額定 Ratings

Rated Power (W)	阻值範圍 Resistance Range (Ω)		最高使用電壓 Max. Working Voltage	最高過負荷電壓 Max. Overload Voltage	耐電壓 Dielectric Withstanding Voltage	溫度係數 T.C.R.	包裝 Taping/Ammo, Forming/Bulk pack (pcs)					
	J±5% (E24)						A52	A64	FT	YT	L	C
1/4	0.1 ~ 100		250V	500V	1,500V	≤ 1Ω : ± 500ppm/°C > 1Ω : ± 300ppm/°C	1000	-	-	-	-	-
1/2							1000	-	-	-	2500	2500
1							1000	-	-	-	1000	1000
2							-	500	-	-	1000	1000
3							-	-	-	-	-	-

■ 額定溫度下降曲線圖 Derating curve

例 Example

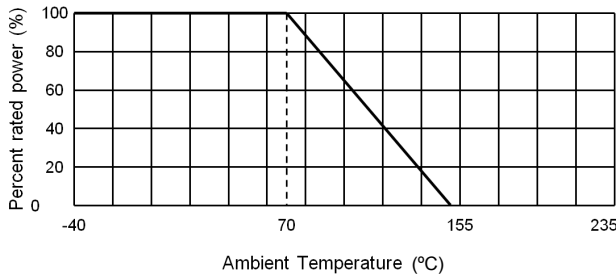

■ 熔斷特性 Fusing characteristics (參考用 Reference)

殘留阻值為公稱阻值 100 倍以上 (Residual resistance \geq 100 times nominal resistance)

1/4W	Power Rating I=constant	Opening Time	1/2W & 1W	Power Rating I=constant	Opening Time	2W & 3W	Power Rating I=constant	Opening Time
	45W	8 sec ~ 40 sec Max		20W	8 sec ~ 35 sec Max		30W	5 sec ~ 35 sec Max
50W	3 sec ~ 15 sec Max	25W	5 sec ~ 20 sec Max	35W	2 sec ~ 10 sec Max			
55W	2sec ~ 8sec Max	30W	2sec ~ 10sec Max	40W	1sec ~ 5sec Max			



※能量可以依客戶需求製作 Energy can be produced according to customer demand

■ 試驗條件與方法 The testing method and condition.

試驗項目 Test Items	規格值 Performance Requirements	試驗方法 Test Methods and Standard.(JISC5201-1)
電阻值 Resistance	規定的誤差值內 Within of specified tolerance	測量點從端蓋 10mm Measuring points are distance 10mm from the end cap(4.5)
溫度係數 T.C.R.	規定值內 Within of specified T.C.R.	室溫+100°C Room temperature +100°C(4.8)
短時間過負荷 Short time overload	$\pm(1\%+0.05\Omega)$	4 倍額定功率，5 秒 4 times the rated power for 5 seconds
負荷壽命 Load life	$\pm(5\%+0.1\Omega)$	Rated voltage at 70°C for 1,000 hours 1.5hr ON / 0.5hr OFF Cycles(4.25.1)
耐濕負荷壽命 Load life in humidity	$\pm(5\%+0.1\Omega)$	10% rate power load 40°C, 95% RH for 1,000 hours 1.5h ON / 0.5h OFF cycle(4.24)
耐濕性 Moisture resistance	$\pm(1\%+0.05\Omega)$	40°C, 95% RH, 240 小時 40°C, 95% RH for 240 hours
溫度循環 Temperature cycle	$\pm(1\%+0.05\Omega)$	5 cycles for -25°C (30min) : room temp. (30min) ~ +85°C (30min) room temp. (30min)(4.19)
焊錫效果 Soldeability	95 % (min) coverage	Temp. of solder 245°C \pm 5°C duration of immersion 3s \pm 0.5s
焊錫耐熱 Resistance to soldering heat	$\pm(1\%+0.05\Omega)$	260°C \pm 5°C for 10 seconds (焊錫槽) 350°C \pm 10°C for 3.5 seconds (手焊錫)(4.18)
絕緣電阻 Insulation resistance	>1,000M Ω	500V 絕緣測試 1 分鐘 500V insulation test 1min.(4.6.1)
不燃性 Flameproof	無燃燒現象 No evidence of flaming or arcing	AC voltage of 2,4,8,16,32 times the power rating for 1min. (V \leq 4 times max. working voltage)

WIRE RESISTOR

RWU 繞線電阻器
WIRE WOUND RESISTOR (Standard Type)

RWS 小型繞線電阻器
WIRE WOUND RESISTOR (Small Type)

RWP 超小型繞線電阻器
WIRE WOUND RESISTOR (Super Small Type)

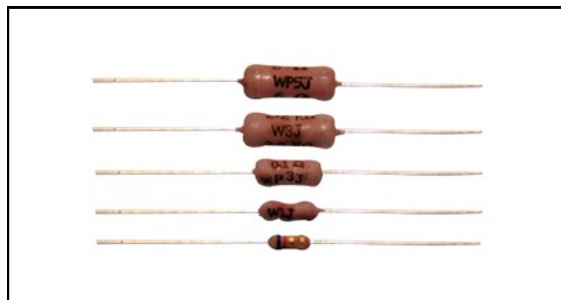

塗料顏色 (Coating Color) :

標準品 (Standard Type) Gray

小型品 (Small Type) Pink

超小型品 (Super Small Type) Pink

標示 (Marking) :

色碼 (Color Code) (RWP1W)

文字 (Alphanumeric) (1/2W~10W)

特性 Feature

◎使用不燃性塗料,具不燃與絕緣之安全特性(UL94 V-0)
Flameproof and insulating coating designed to assure safe usage by special non-flammable silicon-base.
(Equivalent to UL94 V-0)

◎小型化能高密度插裝

Small size are good for high density application.

◎長期穩定性佳

Stable long service life.

◎產品符合歐盟 RoHS 要求

Products is compliance the EU-RoHS request.

產品認證 Approvals awarded

● RWP1W Series UL1412 File No.E257690

額定 Ratings

Rated Power (W)	阻值範圍 Resistance Range (Ω)		最高使用電壓 Max. Working Voltage	耐電壓 Dielectric Withstanding Voltage		溫度係數 T.C.R.	包裝 Taping/Ammo,Forming/Bulk pack (pcs)								
	J±5% (E24)						A26	A52	A64	FT	YT	L	C	M	D
P1	0.1 ~ 100		500V	250V	(UL)1000V	≤ 1Ω : ± 500ppm/°C > 1Ω : ± 300ppm/°C	5000	2500	-	-	-	-	-	-	-
1/2,S1,P2	0.05 ~ 150			350V	-		-	2000	2000	2500	2500	2500	2500	2500	2500
1,S2,P3	0.05 ~ 330			350V	-		-	1000	1000	1000	1000	1000	1000	1000	1000
2,S3,P5	0.05 ~ 1K			500V	-		-	500	500	-	1000	1000	1000	1000	1000
3,S5,7				500V	-		-	-	-	500	500	-	500	-	500
7,10	0.05 ~ 15K	0.05 ~ 27K		500V	-		-	-	-	-	-	-	-	-	-

結構圖 Construction



1	端子線	Lead wire	4	繞線	Wire wound
2	瓷棒	Ceramic base	5	標示	Marking or color code
3	鐵帽	Cap	6	絕緣塗料	Insulation coat

外型尺寸 Dimensions

Rated Power (W)	Dimensions (mm)					Weight (g) (1000pcs)
	L	L1 Max.	D	Ød	ℓ	
P1	6±0.5	7	2.4±0.1	0.6±0.05	28±3	210
P1 (UL)	9.5±1	12	4.5±1	0.7±0.05	28±3	510
1/2,S1,P2	9±0.5	11	3.3±0.5	0.6/0.8±0.05	28±3	285
1,S2,P3	12±1	15	4.5±0.5	0.8±0.05	38±3	728
2,S3,P5	16±1	18	5.5±0.5			1380
3,S5,7	25±1	28	8.5±0.5	0.8±0.05	38±3	3768
10	44MAX	46MAX	8MAX			6200

料號編碼 Type composition 例 Example

RW	U	12	J	1000	A520	NH
型名 Type	品名 Size	額定功率 Rated Power	誤差值 Tolerance	電阻值(Ω) Resistance	二次加工 Forming	端子線 Lead Wire
	U: Standard	12:1/2W	F±1%	R100=0.1	See table below	熱鍍線 Heat plated
	S: Small	01:1W	G±2%	1R00=1		
	P: Super small	02:2W	J±5%	10R0=10		
		03:3W		1000=100		
		05:5W		1001=1K		
		07:7W		1002=10K		

■ 額定溫度下降曲線圖 Derating curve

例 Example



■ 二次加工對應表 Taping & Forming Matrix

Rated Power (W)	Taping			Radial Taping		L Forming				C Forming				F Forming				M Forming			D Forming			
	A26	A52	A64	FT	YT	L10	L12.5	L15	L20	C12.5	C15	C20	C30	FA5	FB5	FC5	FD5	M12.5	M15	M20	D12.5	D15	D20	D30
P1	○	—	—	○	—	○	—	—	—	—	—	—	—	○	○	○	○	—	—	—	—	—	—	—
1/2,S1,P2	—	○	—	○	○	—	○	—	—	—	○	—	—	○	○	○	○	○	—	—	—	○	—	—
1,S2,P3	—	○	—	○	○	—	—	○	—	—	○	—	—	○	○	○	○	—	○	—	—	○	—	—
2,S3,P5	—	○	○	—	○	—	—	—	○	—	—	○	—	○	○	○	○	—	—	○	—	—	○	—
3,S5	—	—	—	—	—	—	—	—	—	—	—	○	—	—	—	—	—	—	—	—	—	—	—	○
7,10	—	—	—	—	—	—	—	—	—	—	—	—	—	—	—	—	—	—	—	—	—	—	—	—

■ 試驗條件與方法 The testing method and condition.

試驗項目 Test Items	規格值 Performance Requirements	試驗方法 Test Methods and Standard.(JISC5201-1)
電阻值 Resistance	規定的誤差值內 Within of specified tolerance	測量點從端蓋 10mm Measuring points are distance 10mm from the end cap(4.5)
溫度係數 T.C.R.	規定值內 Within of specified T.C.R.	室溫+100°C Room temperature +100°C(4.8)
短時間過負荷 Short time overload	±(1%+0.05Ω)	6.25 倍額定功率，5 秒 6.25 times the rated power for 5 seconds(4.13)
負荷壽命 Load life	±(5%+0.1Ω)	Rated voltage at 70°C for 1,000 hours 1.5hr ON / 0.5hr OFF Cycles(4.25.1)
耐濕負荷壽命 Load life in humidity	±(5%+0.1Ω)	10% rate power load 40°C, 95% RH for 1,000 hours 1.5h ON / 0.5h OFF cycle(4.24)
耐濕性 Moisture resistance	±(1%+0.05Ω)	40°C，95% RH，240 小時 40°C, 95% RH for 240 hours
溫度循環 Temperature cycle	±(1%+0.05Ω)	5 cycles for -25°C (30min) : room temp. (30min) ~ +85°C (30min) room temp. (30min)(4.19)
焊錫效果 Soldeability	95 % (min) coverage	Temp. of solder 245°C ± 5°C duration of immersion 3s±0.5s
焊錫耐熱 Resistance to soldering heat	±(1%+0.05Ω)	260°C ± 5°C for 10 seconds (焊錫槽) 350°C ± 10°C for 3.5 seconds (手焊錫)(4.18)
絕緣電阻 Insulation resistance	>1,000MΩ	500V 絕緣測試 1 分鐘 500V insulation test 1min.(4.6.1)
不燃性 Flameproof	無燃燒現象 No evidence of flaming or arcing	AC voltage of 2,4,8,16,32 times the power rating for 1min. (V ≤ 4 times max. working voltage)

NON INDUCTIVE RESISTOR

- NWU** 繞線式無感電阻器
- NMU** NON INDUCTIVE RESISTOR (Wirewound standard Type)
- NWS** 小型繞線式無感電阻器
- NMS** NON INDUCTIVE RESISTOR (Small Wirewound Type)
- NWP** 超小型繞線式無感電阻器
- NMP** NON INDUCTIVE RESISTOR (Super Small Wirewound Type)

- NVU** 皮膜無感精密電阻器
- NVU** NON INDUCTIVE PRECISION RESISTOR (Standard Type)
- NVS** 小型皮膜無感精密電阻器
- NVS** NON INDUCTIVE PRECISION RESISTOR (Small Type)
- NVP** 超小型皮膜無感精密電阻器
- NVP** NON INDUCTIVE PRECISION RESISTOR (Super Small Type)



- 塗料顏色 (Coating Color) :
- 標準品 (Standard Type) Gray
- 小型品 (Small Type) Pink
- 超小型品 (Super Small Type) Pink
- 標示 (Marking) :
- 色碼 (Color Code) (S1/2W)
- 文字 (Alphanumeric) (1/2W~7W)

特性 Feature

- ◎使用不燃性塗料,具不燃與絕緣之安全特性.(UL94 V-0)
Flameproof and insulating coating designed to assure safe usage by special non-flammable silicon-base.
(Equivalent to UL94 V-0)
- ◎小型化能高密度插裝
Small size are good for high density application.
- ◎超低電感量 (1KHz : 3μH 以下)
Low inductance value (1KHz : Under 3μH).
- ◎產品符合歐盟 RoHS 要求
Products is compliance the EU-RoHS request.

參考規格 Reference standards

- JIS C 5201-1

額定 Ratings

Rated Power (W)	阻值範圍 Resistance Range (Ω)			最高使用電壓 Max. Working Voltage	耐電壓 Dielectric Withstanding Voltage	溫度係數 T.C.R.	包裝 Taping/Ammo pack (pcs)				
	NW (Wire)	NM (Film)	NV (Film)				A26	A52	A64	FT	YT
P1	0.1~10	2Ω~ 12M	10Ω~ 3G	750V	NW : 350V NM · NV : 500V	NW Type	5000	2500	—	2000	—
1/2,S1,P2	0.05 ~ 22			—		2000	—	1000	1000		
1,S2,P3	0.05 ~ 47	—		1000		1000	1000	1000			
2,S3,P5	0.05 ~ 100	2Ω~ 14M		—		500	500	1000	1000		
3,S5	0.05 ~ 220	2Ω~ 1M	1500V	—		—	—	—	—		
7			—	—	—	—	—				
10	0.1~1k	10~1M	10000V	—	—	—	—	—			

結構圖 Construction



1	端子線	Lead wire	5	繞線	Wire wound/NW
2	瓷棒	Ceramic base	5	導電層材	Conductive film/NM · NV
3	鐵帽	Cap	6	標示	Marking or color code
4	切割線	Helical cutting groove	7	絕緣塗料	Insulation coat

外型尺寸 Dimensions

Rated Power (W)	Dimensions (mm)					Weight (g) (1000pcs)
	L	L1 Max.	D	Ød	l	
P1	6±0.3	7	2.4±0.1	0.6±0.05 P2:0.7	28±2	210
1/2,S1,P2	9±0.5	11	3.3±0.5		28±3	285
1,S2,P3	12±1	15	4.5±0.5	0.8±0.05	38±3 (S2W S3W 36±3)	728
2,S3,P5	16±1	18	6±1			1380
3,S5	25±1	28	8.5±0.5			3768
7	25±1	28	8.5±0.5			3768
10	40±1	42	8.5±0.5	33±1	6434	

料號編碼 Type composition 例 Example

NW	U	12	J	1000	A520	NH
型名 Type	品名 Size	額定功率 Rated Power	誤差值 Tolerance	電阻值(Ω) Resistance	二次加工 Forming	端子線 Lead Wire
NW	U: Standard	12:1/2W	G±2%	R100=0.1	See table	熱鍍線 Heat plated
NM	S: Small	01:1W	J±5%	1R00=1	below	Heat plated
NV	P: Super small	02:2W		10R0=10		
		03:3W		1000=100		
		05:5W		1001=1K		
		A0:10W		1002=10K		

■ 額定溫度下降曲線圖 Derating curve

例 Example

NW Type



NV Type



■ 二次加工對應表 Taping & Forming Matrix

Rated Power (W)	Taping			Radial Taping		L Forming				C Forming				F Forming				M Forming			D Forming				
	A26	A52	A64	FT	YT	L10	L12.5	L15	L20	C12.5	C15	C20	C30	FA5	FB5	FC5	FD5	M12.5	M15	M20	D12.5	D15	D20	D30	
P1	○	○	-	-	-	-	-	-	-	-	-	-	-	-	-	-	-	-	-	-	-	-	-	-	-
1/2,S1,P2	-	○	-	○	○	-	○	-	-	○	-	-	-	○	○	○	○	○	-	-	○	-	-	-	-
1,S2,P3	-	○	○	○	○	-	-	○	-	-	○	-	-	○	○	○	○	-	○	-	-	○	-	-	-
2,S3,S5,P5	-	○	○	-	○	-	-	-	○	-	-	○	-	○	○	○	○	-	-	○	-	-	○	-	-
3	-	-	-	-	-	-	-	-	-	-	-	○	-	-	-	-	-	-	-	-	-	-	-	○	-
7	-	-	-	-	-	-	-	-	-	-	-	-	-	-	-	-	-	-	-	-	-	-	-	-	-

■ 試驗條件與方法 The testing method and condition.

試驗項目 Test Items	規格值 Performance Requirements	試驗方法 Test Methods and Standard.(JISC5201-1)
電阻值 Resistance	規定的誤差值內 Within of specified tolerance	測量點從端蓋 10mm Measuring points are distance 10mm from the end cap(4.5)
溫度係數 T.C.R.	規定值內 Within of specified T.C.R.	室溫+100°C Room temperature +100°C(4.8)
短時間過負荷 Short time overload	±(1%+0.05Ω)	6.25 倍額定功率，5 秒 6.25 times the rated power for 5 seconds(4.13)
負荷壽命 Load life	±(5%+0.1Ω)	Rated voltage at 70°C for 1,000 hours 1.5hr ON / 0.5hr OFF Cycles(4.25.1)
耐濕負荷壽命 Load life in humidity	±(5%+0.1Ω)	10% rate power load 40°C, 95% RH for 1,000 hours 1.5h ON / 0.5h OFF cycle(4.24)
耐濕性 Moisture resistance	±(1%+0.05Ω)	40°C，95% RH，240 小時 40°C, 95% RH for 240 hours
溫度循環 Temperature cycle	±(1%+0.05Ω)	5 cycles for -25°C (30min) ; room temp.(30min) ~ +85°C (30min) room temp. (30min)(4.19)
焊錫效果 Soldeability	95 % (min) coverage	Temp. of solder 245°C ± 5°C duration of immersion 3s±0.5s
焊錫耐熱 Resistance to soldering heat	±(1%+0.05Ω)	260°C ± 5°C for 10 seconds (焊錫槽) 350°C ± 10°C for 3.5 seconds (手焊錫)(4.18)
絕緣電阻 Insulation resistance	>1,000MΩ	500V 絕緣測試 1 分鐘 500V insulation test 1min.(4.6.1)
不燃性 Flameproof	無燃燒現象 No evidence of flaming or arcing	AC voltage of 2,4,8,16,32 times the power rating for 1min. (V ≤ 4 times max. working voltage)

METAL PLATE CEMENT RESISTOR

MPC 金屬板電阻器
METAL PLATE CEMENT RESISTOR (MPC Type)

MPH 金屬板電阻器
METAL PLATE CEMENT RESISTOR (MPH Type)



Only Available In 4W

本體顏色 (Body color) :

白色 (White)

標示 (Marking) :

Coating color Green

本體顏色 (Body color) :

白色 (White)

塗料顏色 (Coating color)

綠色 (Green)

◎阻值範圍 0.01Ω~25Ω.

Resistance value range 0.01Ω~25Ω.

標示 (Marking) :

文字 (Alphanumeric)

特性 Feature

◎不燃與絕緣之安全設計

Compact type with safety design of Non-flammability and Insulation.

◎低阻值耐突波佳

Low resistance and resilient to surge current.

◎無電感

Non- inductance.

◎產品符合歐盟 RoHS 要求

Products is compliance the EU-RoHS request.

參考規格 Reference standards

● JIS C 5201-1

料號編碼 Type composition

例 Example

MPC	02	J	R010	S000	CP
型名 Type	額定功率 Rated Power	誤差值 Tolerance	電阻值(Ω) Resistance	二次加工 Forming	端子線 Lead Wire
	01:1W	F±1%	R010=0.01	S000 :	CP Wire
	02:2W	G±2%	R100=0.1	Straight	
	03:3W	J±5%	1R00=1	F090 :	
	05:5W	K±10%	10R0=10	Forming	
	A0:10W				

MPH	04	J	R100	S002	CP
型名 Type	額定功率 Rated Power	誤差值 Tolerance	電阻值(Ω) Resistance	二次加工 Forming	端子線 Lead Wire
	04:4W	J±5%	R100=0.1	S002: 2Pin	CP Wire
		K±10%	1R00=1	S004: 4Pin	

額定 Ratings

TYPE	Rated Power (W)	阻值範圍 Resistance Range (Ω)		誤差值 Tolerance	耐電壓 Dielectric Withstanding Voltage	溫度係數 T.C.R.	包裝 Pack (pcs)	
							Straight	Forming
MPC	01	0.01~0.5		F±1% G±2% J±5% K±10%	500V	±100ppm/°C ±200ppm/°C ±350ppm/°C	1000	---
	70	0.1~1.0						
	76	0.01~0.05						
	78	0.1~1.0						
	72	0.1~1.0						
	73	0.006~0.08						
	71	0.1~1.0						
	74	0.01~1.0						
	75	0.01~0.08	1.5~2.2					
	722	0.1~3.3						
	708	0.1~1.0						
	733	0.1~1.0						
	735	0.01~0.08						
	725	0.1~1.0						
MPH	04	0.1~33		K±10%			200	

■結構圖 Construction

MPC & MPH TYPE		MPC Type		MPH Type	
		1W 腳距 P : 5 ±0.5mm		Only Available In 4W	
1	端子線 Lead wire	3	金屬板 Metal board	5	瓷殼 Ceramic case
2	矽水泥 Silicon cement	4	標示 Marking		

■外型尺寸 Dimensions

TYPE	型名 Model	Dimensions (mm)				Weight (g) (1000pcs)
		A	B	C	Ød	
MPC	01	10±1.0	10±1.0	5±0.5	0.8±0.05	1250
	70, 76, 78	8.0±1.0	13±1.0	4±0.5	0.6±0.05	1250
	72, 73	13±1.0	13±1.0	5±0.5	0.6±0.05	2350
	71	18±1.0	14±1.0	5±0.5	0.6±0.05	3400
	74, 75	18±1.0	14±1.0	5±0.5	0.8±0.05	3400
	722	18±1.0	26±1.0	5±0.5	0.8±0.05	5900
	708	9.0±1.0	26±1.0	5±0.5	0.6±0.05	3000
	735	13±1.0	26±1.0	5±0.5	0.6±0.05	5000
	733	13±1.0	26±1.0	5±0.5	0.6±0.05	5000
	725	18±1.0	26±1.0	5±0.5	0.8±0.05	6000
MPH	4	21 ±1.0	15 ±1.0	2.0±0.5	0.6±0.05	1650

■額定溫度下降曲線圖 Derating curve

例 Example



■試驗條件與方法 The testing method and condition.

試驗項目 Test Items	規格值 Performance Requirements	試驗方法 Test Methods and Standard.(JISC5201-1)
電阻值 Resistance	規定的誤差值內 Within of specified tolerance	測量點從端蓋 10mm Measuring points are distance 10mm from the end cap(4.5)
溫度係數 T.C.R.	規定值內 Within of specified T.C.R.	室溫+100°C Room temperature +100°C(4.8)
短時間過負荷 Short time overload	±(2%+0.05Ω)	6.25 倍額定功率，5 秒 6.25 times the rated power for 5 seconds(4.13)
負荷壽命 Load life	±(5%+0.05Ω)	Rated voltage at 70°C for 1,000 hours 1.5hr ON / 0.5hr OFF Cycles(4.25.1)
耐濕負荷壽命 Load life in humidity	±(5%+0.1Ω)	10% rate power load 40°C, 95% RH for 1,000 hours 1.5h ON / 0.5h OFF cycle(4.24)
耐濕性 Moisture resistance	±(2%+0.05Ω)	40°C · 95% RH · 240 小時 40°C, 95% RH for 240 hours
溫度循環 Temperature cycle	±(1%+0.05Ω)	5 cycles for -25°C (30min) : room temp. (30min) ~ +85°C (30min) room temp. (30min)(4.19)
焊錫耐熱 Resistance to soldering heat	±(2%+0.05Ω)	260°C ± 5°C for 10 seconds (焊錫槽) 350°C ± 10°C for 3.5 seconds (手焊錫)(4.18)
絕緣電阻 Insulation resistance	MPH : >10MΩ MPC : >1000MΩ	500V 絕緣測試 1 分鐘 500V insulation test 1min.(4.6.1)

METAL PLATE CEMENT RESISTOR

MPM

金屬板電阻器

METAL PLATE CEMENT RESISTOR (MPM Type)



本體顏色 (Body color) 綠色 (Green)
 白色 (White) 標示 (Marking)
 塗料顏色 (Coating color) 文字 (Alphanumeric)

特性 Feature

◎不燃與絕緣之安全設計

Compact type with safety design of Non-flammability and insulation.

◎低阻值耐突波佳及可用於電流偵測

Low resistance and resilient to surge current, and current sensor application.

◎無電感

Non-inductance.

◎產品符合歐盟 RoHS 要求

Products is compliance the EU-RoHS request.

測試標準 Test Standard

1. JIS C 5201-1

2. R.C loop for Surge test.

結構圖 Construction

MPM 4W

MPM 7W

1	端子線	Lead wire	5	金屬板	Metal board
2	金屬殼	Metal shell	6	捺印	Marking
3	電鍍層	Plating layer	7	絕緣塗料	Insulation coat
4	陶瓷板	Ceramic base			

外形尺寸 Dimensions

型名 Model	Dimensions (mm)						
	A	B	C	h	Ød	P1	P2
MPM 4W	18±0.5	15±1.0	2.0±0.5	15±3	0.60±0.05	5.5±0.5	9.5±0.5
MPM 5W	18±0.5	15±1.0	2.0±0.5	15±3	0.60±0.05	5.5±0.5	9.5±0.5
MPM 7W	32±1.0	15±1.0	3(MAX)	16±3	0.60±0.05	5.0±0.5	9.5±0.5

Ød=0.5±0.05 (36Ω~100MΩ)

Ød=0.8±0.05 for current sensor application

料號編碼 Type composition

例 Example

MPM	04	K	R010	S002	CP
型名 Type	額定功率 Rated Power	誤差值 Tolerance	電阻值(Ω) Resistance	二次加工 Forming	端子線 Lead Wire
	04:4W	F±1%	R010=0.01	S002 :	CP Wire
	05:5W	J±5%	R100=0.1	2Pin	
	07:7W	K±10%	1R00=1 10R0=10	S004 : 4Pin	

額定 Ratings

TYPE	Rated Power (W)	阻值範圍 Resistance Range(Ω)	誤差值 Tolerance	耐電壓 Dielectric Withstanding Voltage	溫度係數 T.C.R.	包裝 Pack (pcs)	
						Straight	Forming
MPM	4	0.01~100M	F±1% J±5% K±10%	500V	Normal Type ± 350ppm/°C CSR ± 100ppm/°C ± 50ppm/°C ± 25ppm/°C	1200	---
	5	0.01~100M					
	7	0.005~100M					

■ 額定溫度下降曲線圖 Derating curve

例 Example

4W



5W



7W



■ 試驗條件與方法 The testing method and condition.

試驗項目 Test Items	規格值 Performance Requirements	試驗方法 Test Methods and Standard.(JISC5201-1)
電阻值 Resistance	規定的誤差值內 Within of specified tolerance	測量點從端蓋 10mm Measuring points are distance 10mm from the end cap(4.5)
溫度係數 T.C.R.	規定值內 Within of specified T.C.R.	室溫+100°C Room temperature +100°C(4.8)
短時間過負荷 Short time overload	±(2%+0.1Ω)	6.25 倍額定功率 · 5 秒 6.25 times the rated power for 5 seconds(4.13)
負荷壽命 Load life	±(5%+0.1Ω)	Rated voltage at 70°C for 1,000 hours 1.5hr ON / 0.5hr OFF Cycles(4.25.1)
耐濕負荷壽命 Load life in humidity	±(5%+0.1Ω)	10% rate power load 40°C, 95% RH for 1,000 hours 1.5h ON / 0.5h OFF cycle(4.24)
耐濕性 Moisture resistance	±(2%+0.05Ω)	40°C · 95% RH · 240 小時 40°C, 95% RH for 240 hours
溫度循環 Temperature cycle	±(1%+0.05Ω)	5 cycles for -25°C (30min) : room temp. (30min) ~ +85°C (30min) room temp. (30min)(4.19)
焊錫耐熱 Resistance to soldering heat	±(1%+0.05Ω)	260°C ± 5°C for 10 seconds (焊錫槽) 350°C ± 10°C for 3.5 seconds (手焊錫)(4.18)
絕緣電阻 Insulation resistance	>10MΩ	500V 絕緣測試 1 分鐘 500V insulation test 1min.(4.6.1)

METAL PLATE CEMENT RESISTOR

MPT 金屬板電阻器
METAL PLATE CEMENT RESISTOR (MPT Type)

MPQ 金屬板電阻器
METAL PLATE CEMENT RESISTOR (MPQ Type)

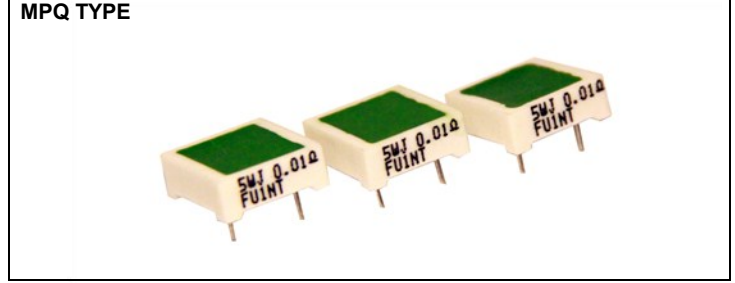

本體顏色 (Body color) :
白 色 (White)
塗料顏色 (Coating color) :
藍 色 (Blue)
標 示 (Marking) :
文 字 (Alphanumeric)

本體顏色 (Body color) :
白 色 (White)
塗料顏色 (Coating color) :
綠 色 (Green)
標 示 (Marking) :
文 字 (Alphanumeric)

特性 Feature

- ◎不燃與絕緣之安全設計
Compact type with safety design of Non-flammability and insulation.
- ◎低阻值耐突波佳
Low resistance and resilient to surge current.
- ◎無電感
Non- inductance.
- ◎產品符合歐盟 RoHS 要求
Products is compliance the EU-RoHS request.
- ◎可依客戶需求製作
Can be produced according to customer's request.

外形尺寸 Dimensions

型名 Model	Dimensions mm					Weight (g) (1000pcs)
	A	B	C	h	Ød	
MPT 03	15 ±1.0	13 ±1.0	0.7±0.1	15±3.0	0.5±0.05	630
MPQ 05	16 ±1.0	16 ±1.0	6.0±0.5	4.5±0.5	0.8±0.05	3110

料號編碼 Type composition

例 Example

MPQ	05	J	R010	S00	CP
型名 Type	額定功率 Rated Power	誤差值 Tolerance	電阻值(Ω) Resistance	二次加工 Forming	端子線 Lead Wire
MPT	03:3W	F±1%	R010=0.01	S000 :	銅線
MPQ	05:5W	G±2%	R100=0.1	Straight	CP Wire
		J±5%	50R0=50		
		K±10%	1000=100		
			1001=1K		
			1002=10K		

額定 Ratings

型名 Model	Rated Power (W)	阻值範圍 Resistance Range(Ω)	耐電壓 Dielectric Withstanding Voltage	溫度係數 T.C.R.	包裝 Plate / Bulk pack(pcs)
		J±5%、K±10%(E24)			
MPT 03	3	36~100M	500V	±350ppm/°C	200
MPQ 05	5	0.01~0.5			

■ 結構圖 Construction

MPT Type				MPQ Type				
1	端子線	Lead wire	3	標示	Marking	4	金屬板	Metal board
2	導電層	Print impedance layer	4	陶瓷板	Ceramic base	5	瓷殼	Ceramic case

■ 額定溫度下降曲線圖 Derating curve

MPT Type

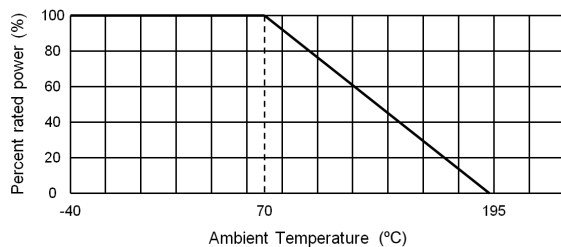

MPQ Type

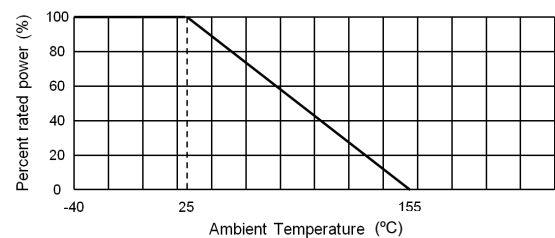

■ 試驗條件與方法 The testing method and condition.

試驗項目 Test Items	規格值 Performance Requirements	試驗方法 Test Methods and Standard.(JISC5201-1)
電阻值 Resistance	規定的誤差值內 Within of specified tolerance	測量點從端蓋 10mm Measuring points are distance 10mm from the end cap(4.5)
溫度係數 T.C.R.	規定值內 Within of specified T.C.R.	室溫+100°C Room temperature +100°C(4.8)
短時間過負荷 Short time overload	±(2%+0.05Ω)	6.25 倍額定功率，5 秒 6.25 times the rated power for 5 seconds(4.13)
負荷壽命 Load life	±(5%+0.1Ω)	Rated voltage at 70°C for 1,000 hours 1.5hr ON / 0.5hr OFF Cycles(4.25.1)
耐濕負荷壽命 Load life in humidity	±(5%+0.1Ω)	10% rate power load 40°C, 95% RH for 1,000 hours 1.5h ON / 0.5h OFF cycle(4.24)
耐濕性 Moisture resistance	±(2%+0.05Ω)	40°C，95% RH，240 小時 40°C, 95% RH for 240 hours
溫度循環 Temperature cycle	±(1%+0.05Ω)	5 cycles for -25°C (30min) : room temp. (30min) ~ +85°C (30min) room temp. (30min)(4.19)
焊錫耐熱 Resistance to soldering heat	±(2%+0.05Ω)	260°C ± 5°C for 10 seconds (焊錫槽) 350°C ± 10°C for 3.5 seconds (手焊錫)(4.18)
絕緣電阻 Insulation resistance	>10MΩ	500V 絕緣測試 1 分鐘 500V insulation test 1min.(4.6.1)
不燃性 Flameproof	無燃燒現象 No evidence of flaming or arcing	AC voltage of 2,4,8,16,32 times the power rating for 1min. (V ≤ 4 times max. working voltage)
脈衝測試 (MPT Type) Pulse withstanding voltage	±20% 	The following discharge cycle is repeated in the circuit of the left 2.5 sec. ON 2.5 sec. OFF 10,000 cycles. With following DC pulse test voltage. Pulse voltage: 10 KV

CEMENT RESISTOR

RGW 水泥電阻器
CEMENT RESISTOR (Wire Type)

RGF 水泥電阻器
CEMENT RESISTOR (film Type)



本體顏色 (Body color) :

白色 (White)

標示 (Marking) :

文字 (Alphanumeric)

特性 Feature

◎不燃與絕緣之安全設計

Compact type with safety design of non-flammability and insulation.

◎可提供低電感

Low inductance is available.

◎長期穩定性佳

Stable long life.

◎可依客戶需求製作

Can be produced according to customer's request.

◎產品符合歐盟 RoHS 要求

Products is compliance the EU-RoHS request.

參考規格 Reference standards

● JIS C 5201-1

額定 Ratings

Rated Power (W)	阻值範圍 Resistance Range(Ω)		最高使用電壓 Max. Working Voltage	最高過負荷電壓 Max. Overload Voltage	耐電壓 Dielectric Withstanding Voltage	溫度係數 T.C.R.
	皮膜型 Film Type	繞線型 Wire wound Type				
1	4~39K	0.1~330	150V	500V	1000V	≤ 1Ω: ± 600 ppm/°C > 1Ω: ± 350 ppm/°C
2	4~39K	0.1~330	150V	750V		
3	4~39K	0.1~330	350V	1000V		
5	4~50K	0.1~1K	350V	1000V		
7	4~100K	0.1~2.2K	500V	1500V		
10	4~100K	0.1~4.7K	750V	1500V		
15	4~100K	1~5.1K	1000V	1500V		
20	4~100K	1~10K	1000V	1500V		
25	4~100K	1~10K	1000V	1500V		
30	4~100K	1~10K	1000V	1500V		
40	4~100K	1~10K	1000V	1500V		

結構圖 Construction

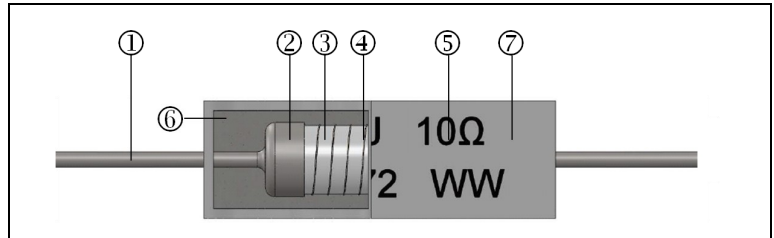

1	端子線	Lead wire	5	標示	Marking
2	鐵帽	Cap			
3	瓷棒	Ceramic base	6	絕緣塗料	Insulation coat
4	繞線/皮膜	Wire wound / Film	7	瓷殼	Ceramic case

料號編碼 Type composition 例 Example

RG	W	01	J	R100	PG00	NH
型名 Type	品名 Size	額定功率 Rated Power	誤差值 Tolerance	電阻值(Ω) Resistance	二次加工 Forming	端子線 Lead Wire
	W: Wire	01:1W	F±1%	R100=0.1	PG00=P Type	NH=Heat
	F: Film	02:2W	G±2%	1R00=1	MG00=M Type	Plated
		05:5W	J±5%	10R0=10	SG00=S Type	NL=Electro
		07:7W	K±10%	1000=100	TG00=T Type	Plated
		A0:10W		1001=1K	HG02=H Type	
		B5:25W		1002=10K		

造型對應表 Type matrix

RG Type	額定功率 (W) Rated Power(W)										
	1	2	3	5	7	10	15	20	25	30	40
P	◎	◎	◎	◎	◎	◎	◎	◎	◎		
Z			◎	◎	◎	◎	◎	◎	◎		
M		◎	◎	◎	◎	◎					
T				◎	◎	◎					
S					◎	◎					
H						◎	◎	◎		◎	◎

RGK TYPE Available : 4W 5W 6W 7W 9W 11W 17W

■ 額定溫度下降曲線圖 Derating curve 例 Example



■ 造型圖 (Dimensions see as APPENDIX)

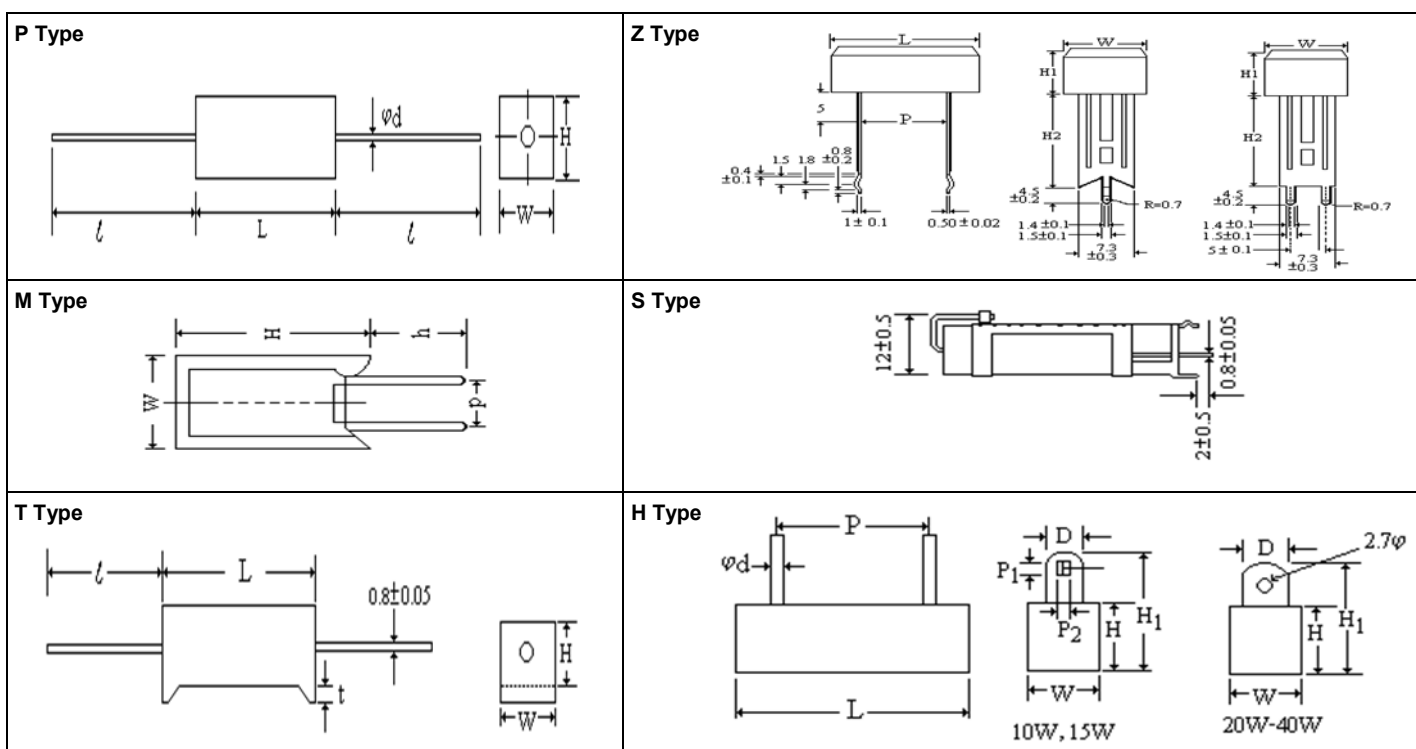

■ 試驗條件與方法 The testing method and condition.

試驗項目 Test Items	規格值 Performance Requirements	試驗方法 Test Methods and Standard.(JISC5201-1)
電阻值 Resistance	規定的誤差值內 Within of specified tolerance	測量點從端蓋 10mm Measuring points are distance 10mm from the end cap(4.5)
溫度係數 T.C.R.	規定值內 Within of specified T.C.R.	室溫+100°C Room temperature +100°C(4.8)
短時間過負荷 Short time overload	±(1%+0.05Ω)	10 倍額定功率 · 5 秒 10 times the rated power for 5 seconds
負荷壽命 Load life	±(5%+0.1Ω)	Rated voltage at 70□ for 1,000 hours 1.5hr ON / 0.5hr OFF Cycles(4.25.1)
耐濕負荷壽命 Load life in humidity	±(5%+0.1Ω)	10% rate power load 40°C, 95% RH for 1,000 hours 1.5h ON / 0.5h OFF cycle(4.24)
溫度循環 Temperature cycle	±(1%+0.05Ω)	5 cycles for -25°C (30min) : room temp. (30min) ~ +85°C (30min) room temp. (30min)(4.19)
焊錫耐熱 Resistance to soldering heat	±(1%+0.05Ω)	260°C ± 5°C for 10 seconds (焊錫槽) 350°C ± 10°C for 3.5 seconds (手焊錫)(4.18)
絕緣電阻 Insulation resistance	>1000MΩ	500V 絕緣測試 1 分鐘 500V insulation test 1min.(4.6.1)

CEMENT RESISTOR

RGK

水泥電阻器
CEMENT RESISTOR (RGK Type)



本體顏色 (Body color) :

白色 (White)

標示 (Marking) :

文字 (Alphanumeric)

特性 Feature

◎不燃與絕緣之安全設計

Compact type with safety design of non-flammability and insulation.

◎可提供低電感

Low inductance is available.

◎長期穩定性佳

Stable long life.

◎可依客戶需求製作

Can be produced according to customer's request.

◎產品符合歐盟 RoHS 要求

Products is compliance the EU-RoHS request.

參考規格 Reference standards

● JIS C 5201-1

額定 Ratings

Rated Power (W)	阻值範圍 Resistance Range(Ω)	溫度係數 T.C.R.	誤差值 Tolerance	最高使用電壓 Max. Working Voltage	最高過負荷電壓 Max. Overload Voltage	耐電壓 Dielectric Withstanding Voltage
4	0.01Ω~ 9.1K	± 350ppm/°C	F±1% G±2% J±5% K±10%	1000V	2000V	2000V
5	0.022Ω~ 15K					
6	0.022Ω~ 15K					
7	0.05Ω~ 30K					
9	0.05Ω~ 33K					
11	0.1Ω~ 47K					
17	0.20Ω~ 82K					

結構圖 Construction



外型尺寸 Dimensions

Rated Power (W)	W (mm)	H (mm)	ℓ (mm)	L (mm)
4	6.8±0.3	6.8±0.3	33±3	25±1
5	6.8±0.3	6.8±0.3		25±1
6	6.8±0.3	6.8±0.3		25±1
7	6.8±0.3	6.8±0.3		33±1
9	9.5±0.5	9.5±0.5		33±1
11	9.0±0.3	9.0±0.3		50±1
17	9.5±0.5	9.0±0.3		75±1

料號編碼 Type composition

例 Example

RGK	05	J	R100	S000	NH
型名 Type	額定功率 Rated Power	誤差值 Tolerance	電阻值(Ω) Resistance	二次加工 Forming	端子線 Lead Wire
	04:4W	F±1%	R010=0.01	See table below	熱鍍線
	05:5W	G±2%	R100=0.1		Heat plated
	07:7W	J±5%	1R00=1		
	A0:10W	K±10%	10R0=10 1000=100 1001=1K 1002=10K		

■ 額定溫度下降曲線圖 Derating curve

例 Example

4W~7W



9W~11W



>15W



■ 試驗條件與方法 The testing method and condition.

試驗項目 Test Items	規格值 Performance Requirements	試驗方法 Test Methods and Standard.(JISC5201-1)
電阻值 Resistance	規定的誤差值內 Within of specified tolerance	測量點從端蓋 10mm Measuring points are distance 10mm from the end cap(4.5)
溫度係數 T.C.R.	規定值內 Within of specified T.C.R.	室溫+100°C Room temperature +100°C(4.8)
短時間過負荷 Short time overload	±(1%+0.05Ω)	6.25 倍額定功率，5 秒 6.25 times the rated power for 5 seconds(4.13)
負荷壽命 Load life	±(5%+0.1Ω)	Rated voltage at 70°C for 1,000 hours 1.5hr ON / 0.5hr OFF Cycles(4.25.1)
耐濕負荷壽命 Load life in humidity	±(5%+0.1Ω)	10% rate power load 40°C, 95% RH for 1,000 hours 1.5h ON / 0.5h OFF cycle(4.24)
溫度循環 Temperature cycle	±(1%+0.05Ω)	5 cycles for -25°C (30min) : room temp.(30min) ~ +85°C (30min) room temp. (30min)(4.19)
焊錫耐熱 Resistance to soldering heat	±(1%+0.05Ω)	260°C ± 5°C for 10 seconds (焊錫槽) 350°C ± 10°C for 3.5 seconds (手焊錫)
絕緣電阻 Insulation resistance	>1000MΩ	500V 絕緣測試 1 分鐘 500V insulation test 1min.(4.6.1)

CURRENT SENSOR RESISTOR

RGC

電流偵測電阻器
CURRENT SENSOR RESISTOR (RGC Type)



本體顏色 (Body color) :

白色 (White)

標示 (Marking) :

文字 (Alphanumeric)

特性 Feature

◎不燃與絕緣之安全設計

Compact type with safety design of non-flammability and insulation.

◎可提供低電感

Low inductance is available.

◎長期穩定性佳

Stable long life.

◎可依客戶需求製作

Can be produced according to customer's request.

◎產品符合歐盟 RoHS 要求

Products is compliance the EU-RoHS request.

參考規格 Reference standards

● JIS C 5201-1

額定 Ratings

Rated Power (W)	阻值範圍 Resistance Range(Ω)	溫度係數 T.C.R.	誤差值 Tolerance	最高使用電壓 Max. Working Voltage	最高過負荷電壓 Max. Overload Voltage	耐電壓 Dielectric Withstanding Voltage
1	0.001Ω ~ 0.1Ω (1mΩ ~ 100mΩ)	±20ppm/°C ±50ppm/°C ±100ppm/°C	F±1% G±2% J±5% K±10%	\sqrt{PR}	$\sqrt{10PR}$	2000V
2						
3						
4						
5						
7						
9						
10						
20						

結構圖 Construction

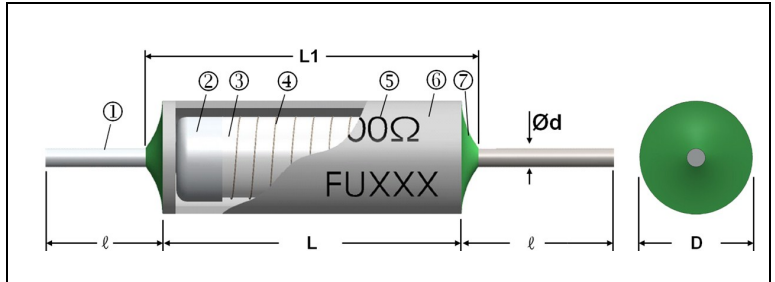

1	端子線	Lead wire	5	標示	Marking
2	瓷棒	Ceramic base	6	絕緣塗料	Insulation coat
3	鐵帽	Cap	7	瓷管 / 瓷殼	Ceramic tube / Ceramic case
4	繞線	Wire wound			

外型尺寸 Dimensions

Rated Power (W)	L (mm)	L1 Maxd (mm)	D (mm)	l (mm)	Ød (mm)
1	11.5±1	15	4.3±1	26±2	0.6±0.05
2	11.5±1	15	4.3±1	26±2	0.6±0.05
3	15±1	19	5.5±1	32±2	0.8±0.05
4	22±1	26	8.0±1	27±3	1.0±0.05
5	22±1	26	8.0±1	30±2	0.8±0.05
7	22±1	26	9.0±1	30±2	0.8±0.05
9	38±1	42	9.0±1	30±2	0.8±0.05
10	37±1	41	10±1	30±2	0.8±0.05
20	42±1	46	12±1	30±2	0.8±0.05

◎ 7W、9W 為方型瓷殼

料號編碼 Type composition

例 Example

RGC	03	J	R100	A52	NH
型名 Type	額定功率 Rated Power	誤差值 Tolerance	電阻值(Ω) Resistance	二次加工 Forming	端子線 Lead Wire
	03:3W	F±1%	R001=0.001	See table below	熱鍍線 Heat plated
	05:5W	G±2%	R010=0.01		
	07:7W	J±5%	R100=0.1		
	A0:10W	K±10%			

■ 額定溫度下降曲線圖 Derating curve

例 Example

4W~7W

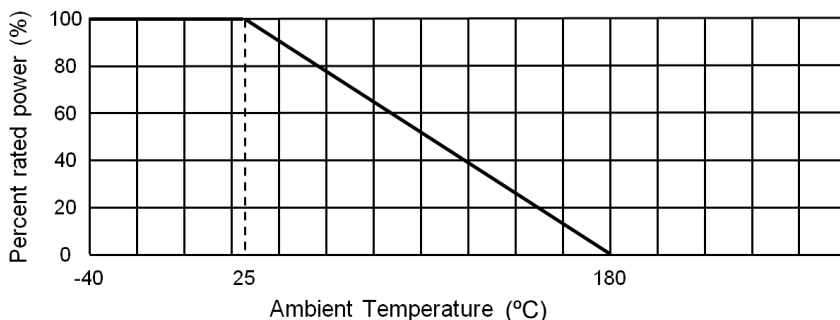

9W~11W



>15W

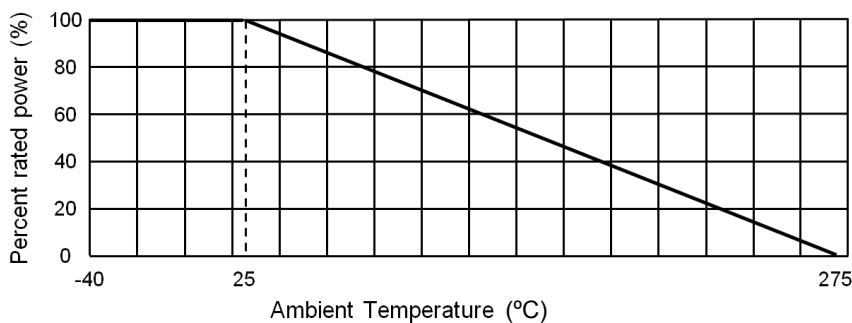

■ 試驗條件與方法 The testing method and condition.

試驗項目 Test Items	規格值 Performance Requirements	試驗方法 Test Methods and Standard.(JISC5201-1)
電阻值 Resistance	規定的誤差值內 Within of specified tolerance	測量點從端蓋 10mm Measuring points are distance 10mm from the end cap(4.5)
溫度係數 T.C.R.	規定值內 Within of specified T.C.R.	室溫+100°C Room temperature +100°C(4.8)
短時間過負荷 Short time overload	±(1%+0.05Ω)	6.25 倍額定功率，5 秒 6.25 times the rated power for 5 seconds(4.13)
負荷壽命 Load life	±(5%+0.1Ω)	Rated voltage at 70°C for 1,000 hours 1.5hr ON / 0.5hr OFF Cycles(4.25.1)
耐濕負荷壽命 Load life in humidity	±(5%+0.1Ω)	10% rate power load 40°C, 95% RH for 1,000 hours 1.5h ON / 0.5h OFF cycle(4.24)
溫度循環 Temperature cycle	±(1%+0.05Ω)	5 cycles for -25°C (30min) : room temp.(30min) ~ +85°C (30min) room temp. (30min)(4.19)
焊錫耐熱 Resistance to soldering heat	±(1%+0.05Ω)	260°C ± 5°C for 10 seconds (焊錫槽) 350°C ± 10°C for 3.5 seconds (手焊錫)(4.18)
絕緣電阻 Insulation resistance	>100MΩ	500V 絕緣測試 1 分鐘 500V insulation test 1min.(4.6.1)

HIGH PULSE WIRE WOUND RESISTOR

HVV

高脈衝繞線電阻器

HIGH PULSE WIRE WOUND RESISTOR (Standard Type)



結構圖 Construction



1	端子線	Lead wire	5	標示	Marking
2	瓷棒	Ceramic base	6	絕緣塗料	Insulation coat
3	鐵帽	Cap			
4	繞線	Wire wound	7	瓷管	Ceramic tube

本體顏色 (Body color) :

白色 (White)

標示 (Marking) :

文字 (Alphanumeric)

外型尺寸 Dimensions

Rated Power (W)	Dimensions(mm)					Weight(g) (1000pcs)
	L	L1 Max.	D	Ød	ℓ	
1	14±2	18	5±1	0.8 ± 0.05	35 ± 3	1250
2	16±2	20	7±1			2250
3	27±2	31	6±1			3000
4	40±2	45	7±1			5500
5	43±2	48	7±1			5900

特性 Feature

◎ 防爆式繞線高脈衝特性

The ANTI-BURST Type wire wound type High pulse safe usage by special non-flammable silicon-base.

◎ 可承受 25KV 突波的衝擊。

Acceptable pulse of 25KV discharge.

◎ 高信賴性

High reliability.

◎ 產品符合歐盟 RoHS 要求

Products is compliance the EU-RoHS request.

料號編碼 Type composition

例 Example

HV	W	01	J	10R0	S000	NH
型名 Type	品名 Size	額定功率 Rated Power	誤差值 Tolerance	電阻值(Ω) Resistance	二次加工 Forming	端子線 Lead Wire
	W: Wire	01:1W	J±5%	10R0=10	See table below	熱鍍線
		02:2W	K±10%	1000=100		Heat plated
		03:3W	M±20%	1001=1K		
		04:4W		1002=10K		
		05:5W		1003=100K		

參考規格 Reference standards

● JIS C 5201-1

額定 Ratings

Rated Power (W)	阻值範圍 Resistance Range(Ω)			最高使用電壓 Max. Working Voltage	最高過負荷電壓 Max. Overload Voltage	耐電壓 Dielectric Withstanding Voltage	溫度係數 T.C.R.	脈衝電壓 Pulse withstanding voltage
	J±5%(E24)	K±10%(E24)	M±20%(E24)					
1	10~390K			300V	600V	250V	±300 ppm/°C	15KV
2				400V	800V			
3				450V	900V	350V		25KV
4				550V	1000V			
5				1100V	500V			

■ 額定溫度下降曲線圖 Derating curve

例 Example



■ 試驗條件與方法 The testing method and condition.

試驗項目 Test Items	規格值 Performance Requirements	試驗方法 Test Methods and Standard.(JISC5201-1)
電阻值 Resistance	規定的誤差值內 Within of specified tolerance	測量點從端蓋 10mm Measuring points are distance 10mm from the end cap(4.5)
溫度係數 T.C.R.	規定值內 Within of specified T.C.R.	室溫+100°C Room temperature +100°C(4.8)
短時間過負荷 Short time overload	±(2%+0.05Ω)	6.25 倍額定功率，5 秒 6.25 times the rated power for 5 seconds(4.13)
負荷壽命 Load life	±(5%+0.1Ω)	Rated voltage at 70°C for 1,000 hours 1.5hr ON / 0.5hr OFF Cycles(4.25.1)
耐濕負荷壽命 Load life in humidity	±(5%+0.1Ω)	10% rate power load 40°C, 95% RH for 1,000 hours 1.5h ON / 0.5h OFF cycle(4.24)
耐濕性 Moisture resistance	±(2%+0.05Ω)	40°C，95% RH，240 小時 40°C, 95% RH for 240 hours
溫度循環 Temperature cycle	±(2%+0.05Ω)	5 cycles for -25°C (30min) : room temp. (30min) ~ +85°C (30min) room temp. (30min)(4.19)
焊錫耐熱 Resistance to soldering heat	±(2%+0.05Ω)	260°C ± 5°C for 10 seconds (焊錫槽) 350°C ± 10°C for 3.5 seconds (手焊錫)(4.18)
絕緣電阻 Insulation resistance	>1,000MΩ	500V 絕緣測試 1 分鐘 500V insulation test 1min.(4.6.1)
脈衝測試 Pulse withstanding voltage	±5%	The following discharge cycle is repeated in the circuit of the left fig. 1 sec. ON 1 sec. OFF 10,000 cycles. With following DC pulse test voltage. Pulse voltage: DC 14 kV



ALUMINUM CASED POWER RESISTOR

GR

黃金鋁殼電阻器

ALUMINUM CASED POWER RESISTOR (GR Type)



外觀顏色 (Body Color) : 標 示 (Marking) :
金 黃 色 (Gold) 文 字 (Alphanumeric)

特性 Feature

◎高穩定性強之設計和高脈衝 20KV

High stability strong construction and anti-surge to 20KV.

◎可依客戶需求製作

Can be produced according to customer's request.

◎產品符合歐盟 RoHS 要求

Products is compliance the EU-RoHS request.

◎可提供低電感

Low inductance is available.

料號編碼 Type composition 例 Example

RG	W	05	J	10R0	P000	GR
型名 Type	品名 Size	額定功率 Rated Power	誤差值 Tolerance	電阻值(Ω) Resistance	二次加工 Forming	端子線 Lead Wire
	Wire	05:5W A0:10W E0:50W P0:300W	F±1% G±2% J±5% K±10%	R100=0.1 1R00=1 10R0=10 1000=100 1001=1K 1002=10K 1005=10M 1007=1000M	P000= Straight P00T= Terminal NW00= No sense winding NWOT= Terminal	Aluminum Cased

結構圖 Construction



1	端子線	Lead wire	5	瓷 棒	Ceramic base
2	鋁 殼	Aluminum case	6	繞線/皮膜	Wire wound / Film
3	矽 水 泥	Silicon cement			
4	鐵 帽	Cap	7	標 示	Marking

外形尺寸 Dimensions (mm)

Rated Power (W)	5	10	25	50	85	100	225~300
D±2	81	85	95	116	93.5	120±3	150
C±1	15.5	19	27	50	75	89	114
A±0.4	11.5	14.5	18	39	64	70	76
L±1	5	33±3	33±3	33±3	9	12.5	18
F±1	16.5	20.5	27.3	29	29	71.5	76
B±0.4	12.5	14	19.5	21.6	10	57	64
E±1	8.5	10	13.4	16	16	46	54
N±0.1	2.2	2.2	2.2	2.2	2.2	---	---
K±0.3	2.5	2.4	3.2	3.2	3.2	4.8	4.8
G±1	8	10	15.5	15.5	15.5	44.5	55.6
J±1	2.2	5	6.6	7.6	8	21	24.4
H±0.2	1.5	2	2.2	2.2	2.2	4.7	6.4

額定 Ratings

型名 Type	Rated Power (W)	材質 Material	阻值範圍 Resistance Range(Ω)		誤差值 Tolerance	溫度係數 T.C.R.	最高使用電壓 Max. Working Voltage	耐電壓 Dielectric Withstanding Voltage
			Standard	Non-inductive				
GR-5	4.5	Film	1.5K~1G	200~10M	F±1% G±2% J±5% K±10%	± 25ppm/°C	1500V	1000V
	5	Wire Wound	0.1Ω~1.5K	0.02~200				
GR-10	8.5	Film	2K~1G	470~10M				
	10	Wire Wound	0.1~2K	0.02~470				
GR-25	20	Film	4.7K~1G	1.2K~10M				
	25	Wire Wound	0.5~4.7K	0.1~1.2K				
GR-50	45	Film	10K~2G	1.5K~1M				
	50	Wire Wound	1~40K	0.2~1.5K				
GR-100	100	Wire Wound	3~25K	0.5~4K				
GR-225	225~300	Wire Wound	3~25K	0.5~4K				
GR-300					± 350ppm/°C			

Note: The highest resistance can be contact our sales.

■ 額定溫度下降曲線圖 Derating curve

例 Example

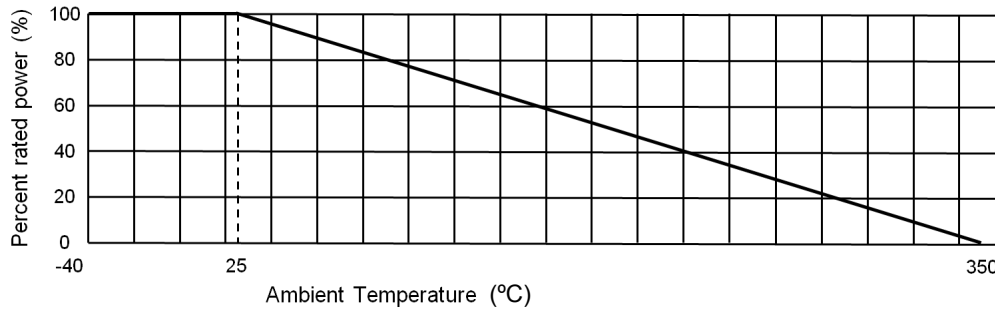

■ 負荷電力對表面溫度上升圖

SURFACE TEMPERATURE RISE Vs. LOADED POWER

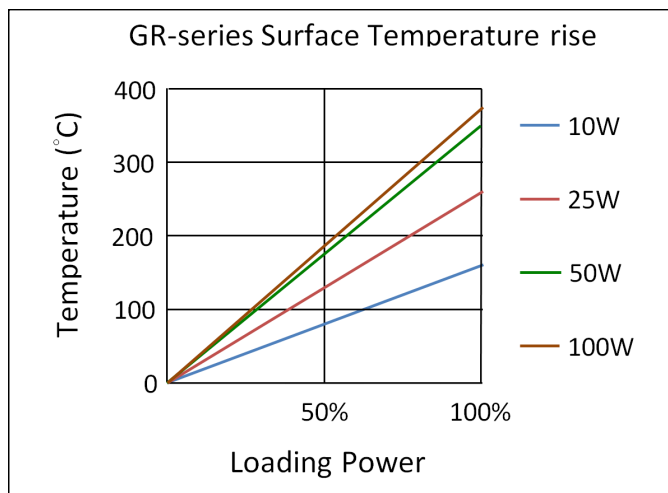

■ 試驗條件與方法 The testing method and condition.

試驗項目 Test Items	規格值 Performance Requirements	試驗方法 Test Methods and Standard.(JISC5201-1)
電阻值 Resistance	規定的誤差值內 Within of specified tolerance	測量點從端蓋 10mm Measuring points are distance 10mm from the end cap(4.5)
溫度係數 T.C.R.	規定值內 Within of specified T.C.R.	室溫+100°C Room temperature +100°C(4.8)
短時間過負荷 Short time overload	±(1%+0.05Ω)	6.25 倍額定功率，5 秒 6.25 times the rated power for 5 seconds(4.13)
負荷壽命 Load life	±(5%+0.1Ω)	Rated voltage at 70°C for 1,000 hours 1.5hr ON / 0.5hr OFF Cycles(4.25.1)
耐濕負荷壽命 Load life in humidity	±(5%+0.1Ω)	10% rate power load 40°C, 95% RH for 1,000 hours 1.5h ON / 0.5h OFF cycle(4.24)
耐濕性 Moisture resistance	±(1%+0.05Ω)	40°C，95% RH，240 小時 40°C, 95% RH for 240 hours
溫度循環 Temperature cycle	±(1%+0.05Ω)	5 cycles for -25°C (30min) : room temp. (30min) ~ +85°C (30min) room temp. (30min)(4.19)
焊錫耐熱 Resistance to soldering heat	±(1%+0.05Ω)	260°C ± 5°C for 10 seconds (焊錫槽) 350°C ± 10°C for 3.5 seconds (手焊錫)(4.18)
絕緣電阻 Insulation resistance	>1,000MΩ	500V 絕緣測試 1 分鐘 500V insulation test 1min.(4.6.1)

FLAT TYPE METAL CLAD WIRE WOUND RESISTOR

GH

薄型鋁殼電阻器

FLAT TYPE METAL CLAD WIRE WOUND RESISTOR (GH Type)



外觀顏色 (Body Color) :

銀 色 (Silver)

標 示 (Marking) :

文 字 (Alphanumeric)

特性 Feature

◎精密型高額定功率

High power rating, and ultra precision.

◎可依客戶需求製作

Can be produced depending on to customer's request.

◎產品符合歐盟 RoHS 要求

Products is compliance the EU-RoHS request.

◎可提供低電感 (≤ 1KHz : 3μH)

Low inductance is available.

料號編碼 Type composition 例 Example

RG	W	J0	J	10R0	S245	GH
型名 Type	品名 Size	額定功率 Rated over	誤差值 Tolerance	電阻值(Ω) Resistance	二次加工 Forming	薄型鋁殼 Aluminum
	Wire	J0:100W M0:150W	J±5%	R100=0.1 1R00=1 10R0=10 1000=100 1001=1K	Straight Length	Aluminum Cased

結構圖 Construction

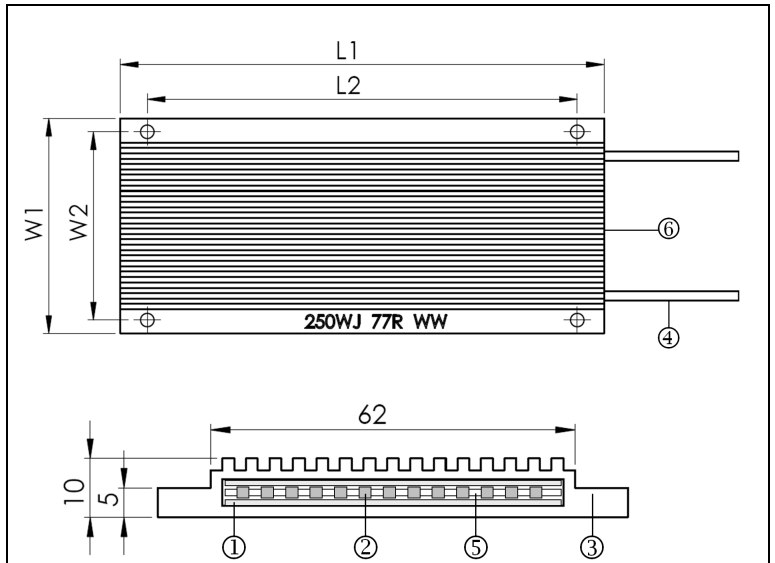

4 XØ5.0 (100W~250W)

6 XØ5.0 (300W~500W)

1	絕緣板	Insulation plate	5	基板	Ceramic base
2	繞線	Wire wound	6	絕緣塗料	Insulation coat
3	鋁殼	Aluminum case			
4	絕緣電線	Silicon rubber wire	7	標示	Marking

外型尺寸 Dimensions

Rated Power (W)	L1±2 (mm)	L2±2 (mm)	W1±2 (mm)	W2±2 (mm)
100	90	70	80	70
150	120	100		
200	150	130		
250	180	160		
300	210	190		
400	270	250		
500	330	310		

額定 Ratings

Rated Power (W)	阻值範圍 Resistance Range(Ω)		誤差值 Tolerance	溫度係數 T.C.R.	最高使用電壓 Max. Working Voltage	最高過負荷電壓 Max. Overload Voltage	耐電壓 Dielectric Withstanding Voltage
	Standard	Non-inductive					
60	0.1Ω~ 500Ω	0.05Ω~ 10KΩ	J±5%	±350ppm/°C	500V	1500V	1500V/DC
100	1Ω~ 1.0KΩ	2Ω~ 500Ω					
150	1Ω~ 1.2KΩ	2Ω~ 600Ω					
200	1Ω~ 1.4KΩ	2Ω~ 700Ω			750V		
250	1Ω~ 1.6KΩ	2Ω~ 800Ω					
300	1Ω~ 1.8KΩ	2Ω~ 900Ω					
400	1Ω~ 2.0KΩ	2Ω~ 1KΩ			1000V		
500	1Ω~ 2.5KΩ	2Ω~ 1.2KΩ					

■ 額定溫度下降曲線圖 Derating curve

例 Example



■ 試驗條件與方法 The testing method and condition.

試驗項目 Test Items	規格值 Performance Requirements	試驗方法 Test Methods and Standard.(JISC5201-1)
電阻值 Resistance	規定的誤差值內 Within of specified tolerance	測量點從端蓋 10mm Measuring points are distance 10mm from the end cap(4.5)
溫度係數 T.C.R.	規定值內 Within of specified T.C.R.	室溫+100°C Room temperature +100°C(4.8)
短時間過負荷 Short time overload	±(1%+0.05Ω)	5 倍額定功率，5 秒 5 times the rated power for 5 seconds
負荷壽命 Load life	±(5%+0.1Ω)	Rated voltage at 70°C for 1,000 hours 1.5hr ON / 0.5hr OFF Cycles(4.25.1)
耐濕負荷壽命 Load life in humidity	±(5%+0.1Ω)	10% rate power load 40°C, 95% RH for 1,000 hours 1.5h ON / 0.5h OFF cycle(4.24)
耐濕性 Moisture resistance	±(1%+0.05Ω)	40°C, 95% RH, 240 小時 40°C, 95% RH for 240 hours
溫度循環 Temperature cycle	±(1%+0.05Ω)	5 cycles for -25°C (30min) : room temp. (30min) ~ +85°C (30min) room temp. (30min)(4.19)
絕緣電阻 Insulation resistance	>1,000MΩ	500V 絕緣測試 1 分鐘 500V insulation test 1min.(4.6.1)

SQUARE SHAPE ALUMINUM SHELL RESISTOR

RA

方型鋁殼電阻器

SQUARE SHAPE ALUMINUM SHELL RESISTOR (RA Type)



結構圖 Construction



外觀顏色 (Body Color) : 標示 (Marking) :
銀色 (Silver) 文字 (Alphanumeric)

特性 Feature

◎精密型高額定功率

High power rating, and ultra precision.

◎可依客戶需求製作

Can be produced according to customer's request.

◎產品符合歐盟 RoHS 要求

Products is compliance the EU-RoHS request.

◎可提供低電感

Low inductance is available.

外型尺寸 Dimensions

Rated Power (W)	L1±2 (mm)	L2±2 (mm)
60	50	75
80	70	95
100	85	110
120	100	130
150	140	165
200	160	200
300	240	280
400	320	360
500	400	440
600	480	520
800	560	600

料號編碼 Type composition

例 Example

RA	SQ	301	J	10R0	NP00
型名 Type	品名 Size	額定功率 Rated power	誤差值 Tolerance	電阻值(Ω) Resistance	無感/端片 No sense-end piece
	Square Shape	600:60W 101:100W 301:300W 801:800W	J±5%	R100=0.1 1R00=1 10R0=10 1000=100 1001=1K	S300: 300mm Straight Length

額定 Ratings

Rated Power (W)	阻值範圍 Resistance Range(Ω)		誤差值 Tolerance	溫度係數 T.C.R.	最高使用電壓 Max. Working Voltage	最高過負荷電壓 Max. Overload Voltage	耐電壓 Dielectric Withstanding Voltage
	Standard	Non-inductive					
60	0.001 ~ 5K	0.1 ~ 100Ω	J±5%	±350ppm/°C	1000V	2000V	AC 1500V
80	0.001 ~ 6K	0.2 ~ 100Ω					
100	0.001 ~ 8K	0.2 ~ 100Ω					
120	0.001 ~ 10K	0.2 ~ 100Ω					
150	0.001 ~ 12K	0.2 ~ 100Ω					
200	0.001 ~ 15K	0.2 ~ 150Ω					
300	0.001 ~ 18K	0.5 ~ 150Ω					
400	0.001 ~ 20K	0.5 ~ 200Ω					
500	0.001 ~ 25K	0.5 ~ 500Ω					
600	0.001 ~ 30K	1 ~ 1K					
800	0.001 ~ 30K	1 ~ 1K					

■ 額定溫度下降曲線圖 Derating curve

例 Example

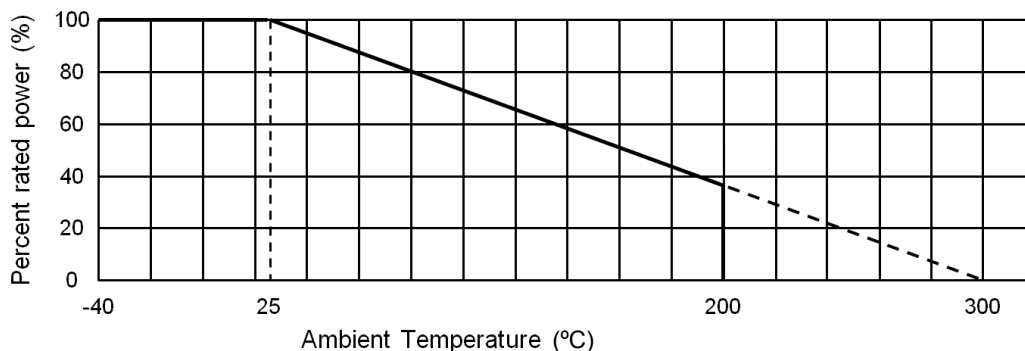

■ 負荷電力對表面溫度上升圖

SURFACE TEMPERATURE RISE Vs. LOADED POWER



■ 試驗條件與方法 The testing method and condition.

試驗項目 Test Items	規格值 Performance Requirements	試驗方法 Test Methods and Standard.(JISC5201-1)
電阻值 Resistance	規定的誤差值內 Within of specified tolerance	測量點從端蓋 10mm Measuring points are distance 10mm from the end cap(4.5)
溫度係數 T.C.R.	規定值內 Within of specified T.C.R.	室溫+100°C Room temperature +100°C(4.8)
短時間過負荷 Short time overload	±(2%+0.05Ω)	10 倍額定功率 · 5 秒 10 times the rated power for 5 seconds
負荷壽命 Load life	±(5%+0.1Ω)	Rated voltage at 70°C for 1,000 hours 1.5hr ON / 0.5hr OFF Cycles(4.25.1)
耐濕負荷壽命 Load life in humidity	±(3%+0.1Ω)	10% rate power load 40°C, 95% RH for 1,000 hours 1.5h ON / 0.5h OFF cycle(4.24)
耐濕性 Moisture resistance	±(3%+0.05Ω)	40°C, 95% RH, 500 小時 40°C, 95% RH for 500 hours
溫度循環 Temperature cycle	±(1%+0.05Ω)	5 cycles for -25°C (30min) : room temp. (30min) ~ +85°C (30min) room temp. (30min)(4.19)
耐電壓 Dielectric withstanding voltage	±(0.2%+0.05Ω)	Test voltage : 1,500 V Duration time 60 s
絕緣電阻 Insulation resistance	>1,000MΩ	500V 絕緣測試 1 分鐘 500V insulation test 1min.(4.6.1)
耐熱性 Heat Resistance	±(0.5%+0.05Ω)	Temp. 275°C for 2 hours.

TRAPEZOID ALUMINUM SHELL RESISTOR

RAMH

船型鋁殼電阻器

TRAPEZOID ALUMINUM SHELL RESISTOR (RAMH Type)



外觀顏色 (Body Color) : 標示 (Marking) :
 銀色 (Silver) 文字 (Alphanumeric)

特性 Feature

◎精密型高額定功率

High power rating, and ultra precision.

◎可依客戶需求製作(尺寸、功率、電感值)

Can be produced according to customer's request.

◎產品符合歐盟 RoHS 要求

Products is compliance the EU-RoHS request.

◎可提供低電感

Low inductance is available.

料號編碼 Type composition

例 Example

RA	MH	301	J	10R0	S000
型名 Type	品名 Size	額定功率 Rated power	誤差值 Tolerance	電阻值(Ω) Resistance	直線 Straight
	Ship Type	600:60W 101:100W 301:300W 801:800W 102:1000W	J±5%	R100=0.1 1R00=1 10R0=10 1000=100 1001=1K	S200: 200mm Straight Length

額定 Ratings

Rated Power (W)	阻值範圍 Resistance Range(Ω)		誤差值 Tolerance	溫度係數 T.C.R.	最高使用電壓 Max. Working Voltage	最高過負荷電壓 Max. Overload Voltage	耐電壓 Dielectric Withstanding Voltage
	Standard	Non-inductive					
60	0.001 ~ 5K	0.1 ~ 100Ω	J±5%	±350ppm/°C	1000V	2000V	AC 1500V
80	0.001 ~ 6K	0.2 ~ 100Ω					
100	0.001 ~ 8K	0.2 ~ 100Ω					
120	0.001 ~ 10K	0.2 ~ 100Ω					
150	0.001 ~ 12K	0.2 ~ 100Ω					
200	0.001 ~ 15K	0.2 ~ 150Ω					
300	0.001 ~ 18K	0.5 ~ 150Ω					
400	0.001 ~ 20K	0.5 ~ 200Ω					
500	0.001 ~ 25K	0.5 ~ 500Ω					
600	0.001 ~ 30K	1 ~ 1K					
800	0.001 ~ 30K	1 ~ 1K					

結構圖 Construction



外型尺寸 Dimensions

Rated Power (W)	L1±2 (mm)	L2±2 (mm)	P±1.5 (mm)
60	50	80	62
80	60	90	72
100	75	105	87
120	90	120	102
150	120	150	132
200	140	170	152
300	180	210	192
400	230	260	242
500	300	330	312
600	360	390	372
800	400	430	412
1000	530	560	542

NOTE: 1. The impedance value request is over above table, please contact our sales.
 2. The TCR request please ask before order.

■ 額定溫度下降曲線圖 Derating curve

例 Example

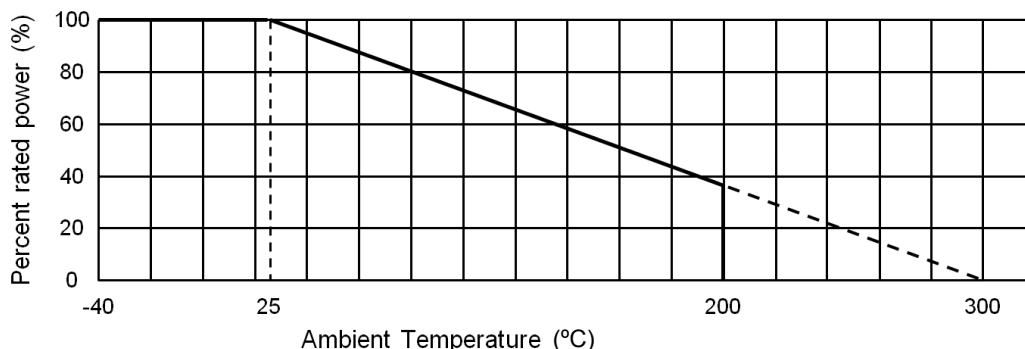

■ 負荷電力對表面溫度上升圖

SURFACE TEMPERATURE RISE Vs. LOADED POWER



NOTE:

1. Pulse function can design for client request. Please contact our sales.
2. We can offer the Temperature probe design of impedance wire inner.

■ 試驗條件與方法 The testing method and condition.

試驗項目 Test Items	規格值 Performance Requirements	試驗方法 Test Methods and Standard.(JISC5201-1)
電阻值 Resistance	規定的誤差值內 Within of specified tolerance	測量點從端蓋 10mm Measuring points are distance 10mm from the end cap(4.5)
溫度係數 T.C.R.	規定值內 Within of specified T.C.R.	室溫+100°C Room temperature +100°C(4.8)
短時間過負荷 Short time overload	±(2%+0.05Ω)	10 倍額定功率 · 5 秒 10 times the rated power for 5 seconds
負荷壽命 Load life	±(5%+0.1Ω)	Rated voltage at 70°C for 1,000 hours 1.5hr ON / 0.5hr OFF Cycles(4.25.1)
耐濕負荷壽命 Load life in humidity	±(5%+0.1Ω)	10% rate power load 40°C, 95% RH for 1,000 hours 1.5h ON / 0.5h OFF cycle(4.24)
耐濕性 Moisture resistance	±(3%+0.05Ω)	40°C, 95% RH, 500 小時 40°C, 95% RH for 500 hours
溫度循環 Temperature cycle	±(1%+0.05Ω)	5 cycles for -25°C (30min) : room temp. (30min) ~ +85°C (30min) room temp. (30min)(4.19)
耐電壓 Dielectric withstanding voltage	±(0.2%+0.05Ω)	Test voltage : 1,500 V Duration time 60 s
絕緣電阻 Insulation resistance	>1,000MΩ	500V 絕緣測試 1 分鐘 500V insulation test 1min.(4.6.1)
耐熱性 Heat Resistance	±(0.5%+0.05Ω)	Temp. 275°C for 2 hours.

POWER WIRE WOUND RESISTOR

RQ

大功率型電阻器

POWER WIRE WOUND RESISTOR (Fixed & Non-inductive Type ; Adjustable Type)



塗料顏色 (Coating Color) : 標示 (Marking) :
綠色 (Green) 文字 (Alphanumeric)

◎可提供低電感

◎防爆式繞線高脈衝特性

The ANTI-BURST Type wire wound type High pulse safe usage by special non-flammable silicon-base.

◎可承受 25KV 突波的衝擊

Acceptable pulse of 25KV discharge.

◎高信賴性

High reliability.

◎產品符合歐盟 RoHS 要求

Products is compliance the EU-RoHS request.

◎可提供低電感

Low inductance is available.

料號編碼 Type composition 例 Example

RQ	FR	100	J	10R0	C2	HG
型名 Type	品名 Size	額定功率 Rated Power	誤差值 Tolerance	電阻值(Ω) Resistance	銅環數 Copper ring	樣式 style
	FR: Fixed	100:10W	J±5%	10R0=10	C2:2Ring	HG:臥式
	NR: Non-inductive	101:100W	K±10%	1000=100	C3:3Ring	VZ:立式
	MR: Adjustable	102:1000W		1001=1K	C4:4Ring	VN:無
				1002=10K		
				1003=100K		

結構圖 Construction

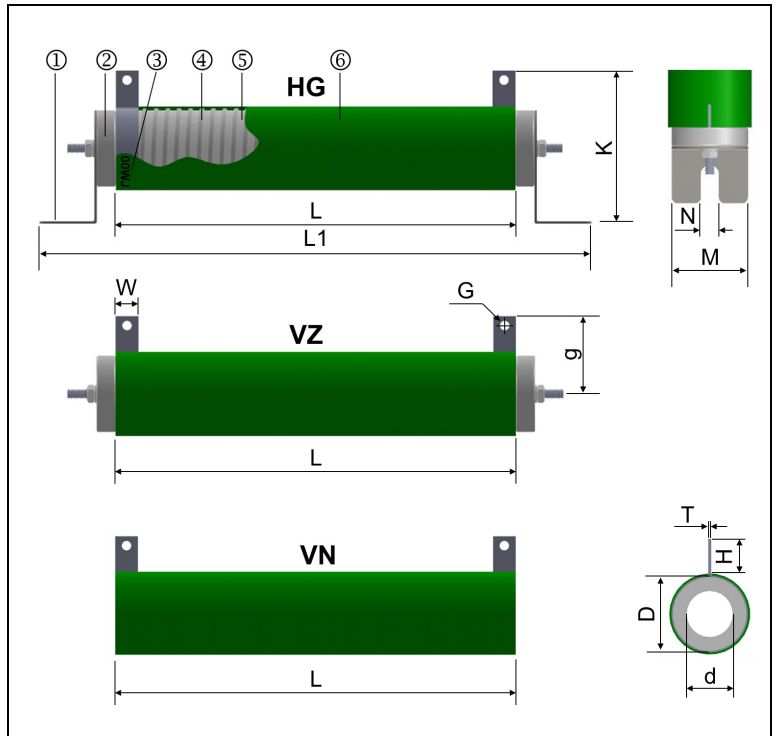

1	鐵架	Iron stand	4	繞線	Wire wound
2	陶瓷墊圈	Ceramic washer		瓷棒	Ceramic base
3	標示	Marking	6	絕緣塗料	Insulation coat

額定溫度下降曲線圖 Derating curve

例 Example



外型尺寸 Dimensions

Dimensions (mm)	Rated Power (W)																						
	10	20	30	50	60	80	100	120	150	160	200	250	300	400	500	600	700	800	1000	1300	1500	2000	
L±2	45	60	75	110	90	110	140	160	195	L±4	185	210	210	260	330	330	400	460	460	540	600	600	650
D±1	12	17	17	25	28	28	28	28	28	D±2	35	35	40	40	40	50	50	50	60	60	65	65	65
g±1	18	22	22	30	32	32	32	32	32	g±2	36	36	38	38	38	50	50	50	55	55	62	62	62
W±1	4	5	5	8	8	8	8	8	8	W±2	10	10	12	12	12	12	10	12	15	15	15	15	15
G±1	2	2	2	5	5	5	5	5	5	G±1	5	5	5	5	5	6	4	6	6	6	6	6	6
H±1	9	12	12	18	19	19	19	19	17	H±1	19	19	20	20	20	25	25	25	30	30	30	30	30
N±0.5	3	4	4	6	6	6	6	6	6	N±2	8	10	8	8	8	9	9	9	10	10	10	10	10
L1±2	62	90	112	166	146	166	196	216	251	L1±1	245	284	274	335	403	410	480	530	535	615	722	722	722
K±2	28	36	36	60	60	60	60	60	60	K±4	76	76	78	78	82	110	110	100	110	110	115	115	115
T±0.3	1	1	1	1.2	1.2	1.2	1.2	1.2	1.2	T±0.3	1.6	1.6	1.6	1.6	1.6	1.6	1.6	1.6	1.6	1.6	1.6	1.6	1.6
M±1	10	17	17	28	28	28	28	28	28	M±2	40	40	40	40	40	48	48	48	50	50	50	50	50

NOTE: Over above table list request please contact sales.

■ 額定 Ratings

Rated Power (W)	阻值範圍 Resistance Range (Ω)			誤差值 Tolerance	溫度係數 T.C.R.	最高使用電 Max. Working Voltage	耐電壓 Dielectric Withstanding Voltage
	標準 Standard ; FR	無感 Non-inductive ; NR	可調 Adjustable ; MR				
10	1-3KΩ		-----	J±5% K±10%	±350ppm/°C	1500V	750V
20	1-7KΩ		1-360Ω				
30	1-10KΩ		1-500Ω				
50	0.1-25KΩ	0.1-8KΩ	1-1.3KΩ				
60	0.1-30KΩ	0.1-10KΩ	1-1.5KΩ				
80	0.1-40KΩ	0.1-20KΩ	0.1-2KΩ				
100	0.1-50KΩ	0.1-25KΩ	0.1-2.4KΩ				
120	0.1-60KΩ	0.1-30KΩ	0.1-3KΩ				
150	0.3-75KΩ	0.3-35KΩ	0.3-3.6KΩ				
160	0.3-80KΩ	0.3-40KΩ	0.3-3.9KΩ				
200	0.3-100KΩ	0.3-50KΩ	0.3-5KΩ				
250	0.5-125KΩ	0.5-60KΩ	0.3-6.2KΩ				
300	0.5-150KΩ	0.5-75KΩ	0.3-7.5KΩ				
400	0.5-200KΩ	0.5-100KΩ	0.5-10KΩ				
500	0.5-250KΩ	0.5-120KΩ	0.5-13KΩ				
600	0.8-300KΩ	0.8-150KΩ	0.5-15KΩ				
700	0.8-350KΩ	0.8-180KΩ	0.5-18KΩ				
800	0.8-400KΩ	0.8-200KΩ	0.8-20KΩ				
1000	1-500KΩ	1-250KΩ	1-25KΩ				
1300	1-500KΩ	1-250KΩ	1-25KΩ				
1500	1-500KΩ	1-250KΩ	1-25KΩ				
2000	1-750KΩ	1-300KΩ	1-39KΩ				

NOTE: impedance request is over above table, please contact sales.

■ 試驗條件與方法 The testing method and condition.

試驗項目 Test Items	規格值 Performance Requirements	試驗方法 Test Methods and Standard.(JISC5201-1)
電阻值 Resistance	規定的誤差值內 Within of specified tolerance	測量點從端蓋 10mm Measuring points are distance 10mm from the end cap(4.5)
溫度係數 T.C.R.	規定值內 Within of specified T.C.R.	室溫+100°C Room temperature +100°C(4.8)
短時間過負荷 Short time overload	±(2%+0.1Ω)	6.25 倍額定功率，5 秒 6.25 times the rated power for 5 seconds(4.13)
負荷壽命 Load life	±(1%+0.1Ω)	Rated voltage at 70°C for 1,000 hours 1.5hr ON / 0.5hr OFF Cycles(4.25.1)
耐濕負荷壽命 Load life in humidity	±(1%+0.1Ω)	10% rate power load 40°C, 95% RH for 1,000 hours 1.5h ON / 0.5h OFF cycle(4.24)
耐濕性 Moisture resistance	±(3%+0.1Ω)	40°C, 95% RH, 500 小時 40°C, 95% RH for 500 hours
耐電壓 Dielectric withstanding voltage	Flash over, burning, insulation damage should not be observed	Test voltage : 750 V (MR 可調品除外) Duration time 60 s
絕緣電阻 Insulation resistance	>100MΩ	500V 絕緣測試 1 分鐘 (MR 可調品除外) 500V insulation test 1min.(4.6.1)

COAT- INSULATED ZERO OHM RESISTOR

- RZU** ■ 塗裝防火型 0Ω電阻器
- RZS** ■ FIRE PREVENTION COAT ZERO OHM RESISTOR (RZU Type , RZS Type)
- RZY** ■ 絕緣樹脂型 0Ω電阻器
- RZY** ■ INSULATION RESIN ZERO OHM RESISTOR (RZY Type)
- RZT** ■ 鐵芯型 0Ω電阻器
- RZT** ■ IRON CORE ZERO OHM RESISTOR (RZT Type)



■結構圖 Construction

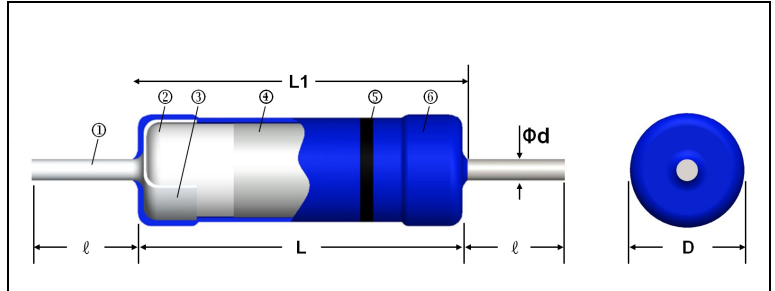

1	端子線	Lead wire	5	電鍍錫	Tin plating
2	瓷棒	Ceramic base	6	標示	Marking or color code
3	鐵帽	Cap			
4	鐵蕊	Iron core	7	絕緣塗料	Insulation coat

塗料顏色 (Coating Color) :

RZU fire prevention coat (Gray) · RZS (pink)

RZU 塗裝防火型(灰色) · RZS (粉紅色)

RZY Insulation resin (Yellowish) · RZT iron core. (or blue)

RZY 絕緣樹脂(淡黃色) · RZT 鐵芯型(or 藍色)

標 示 (Marking) : 色環 Color Code(≤ S1/2W)

文字 Alphanumeric (1/2W · 1W)

■外型尺寸 Dimensions

Rated Power(W)	Dimensions(mm)					Weight(g) (1000pcs)
	L	L1 Max.	D	Ød	ℓ	
1/8, 1/6	3.3±0.3	4	1.8±0.3	0.45±0.05	28±2	120
1/4	6.0±0.3	7	2.4±0.1	0.6±0.05	28±2	218
1/2	9±0.5	11.1	3.0±0.5	0.6±0.05	28±3	320
S1	9±0.5	11.1	3.0±0.5	0.6±0.05	28±3	320

■特性 Feature

◎可自動插件

Automatic insertion is applicable.

◎長期穩定性佳

Excellent long term stability.

◎產品符合歐盟 RoHS 要求

Products is compliance the EU-RoHS request.

■料號編碼 Type composition

例 Example

RZ	U	14	X	R000	A520	NH
型名 Type	品名 Size	額定功率 Rated Power	誤差值 Tolerance	電阻值(Ω) Resistance	二次加工 Forming	端子線 Lead Wire
	U: Standard	16:1/6W	無註記	0Ω	See table below	熱鍍線 Heat plated
	S: Small	14:1/4W				
		12:1/2W				
		01:1W				

■參考規格 Reference standards

● JIS C 5201-1

■額定 Ratings

Rated Power (W)	阻值範圍 Resistance Range (Ω)	最高使用電流 Maxi. Amperage	耐電壓 Dielectric Withstanding Voltage	包裝 Taping/Ammo,Forming/Bulk pack (pcs)	
				A26	A52
RZU1/6	<20mΩ	1.5A	300V	5000	5000
RZU1/4		2.5A			
RZU1/2		2.5A			
RZS1		2.5A			
RZT1/6	<5mΩ	10A	300V	5000	5000
RZT1/4		15A			
RZY1/6	<20mΩ	3A	300V	5000	5000
RZY1/4		5A			

■ 額定溫度下降曲線圖 Derating curve

例 Example

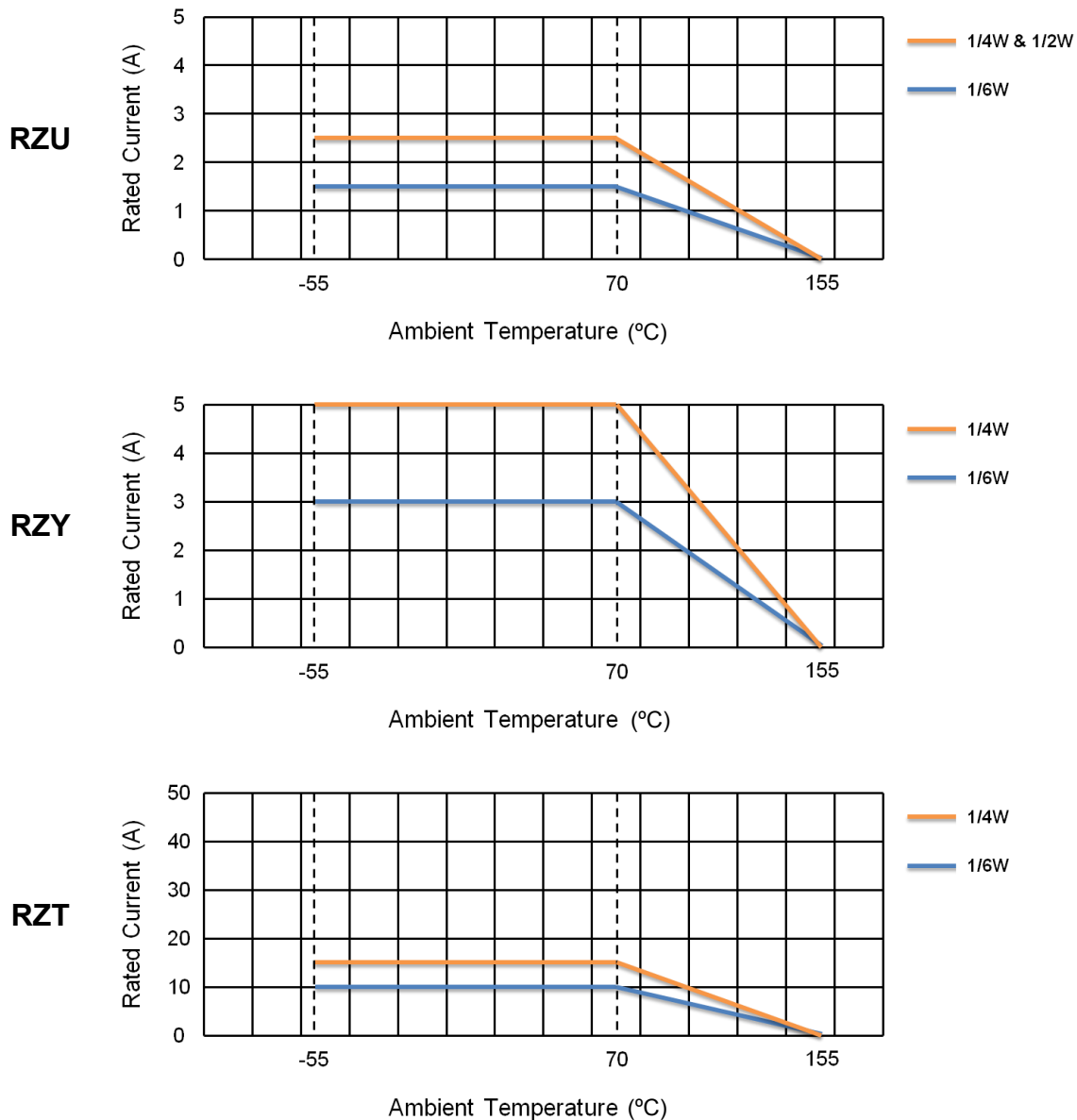

■ 試驗條件與方法 The testing method and condition.

試驗項目 Test Items	規格值 Performance Requirements	試驗方法 Test Methods and Standard.(JISC5201-1)
電阻值 Resistance	規定的誤差值內 Within of specified tolerance	測量點從端蓋 10mm Measuring points are distance 10mm from the end cap(4.5)
焊錫效果 Solder ability	After test, <20mΩ	Temp. of solder 245°C ± 5°C duration of immersion 5 s ± 0.5 s
負荷壽命 Load life	After test, <20mΩ	額定電流 70°C, 1,000 小時 Rated Amperage at 70°C for 1,000 hours
耐濕負荷壽命 Load life in humidity	After test, <20mΩ	10% rate power load 40°C, 95% RH for 1,000 hours 1.5h ON / 0.5h OFF cycle(4.24)
溫度循環 Temperature cycle	After test, <20mΩ	5 cycles for -25°C (30min) : room temp. (30min) ~ +85°C (30min) room temp. (30min)(4.19)
焊錫耐熱 Resistance to soldering heat	After test, <20mΩ	260°C ± 5°C for 10 seconds (焊錫槽) 350°C ± 10°C for 3.5 seconds (手焊錫)(4.18)

LOW RESISTANCE RESISTOR

ST 低阻值電阻器 LOW RESISTANCE RESISTOR (ST Type)

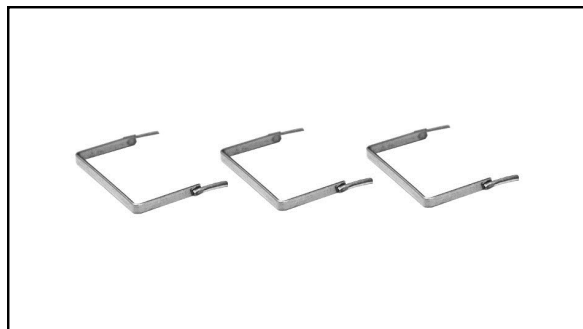

本體顏色 (Body color) :

銀 色 (Silver)

結構圖 Construction



特性 Feature

◎尺寸小且重量輕

Small size and light weight.

◎焊錫特性佳

Excellent soldering performance.

◎可依客戶需求製作

Can be produced according to customer's request.

◎產品符合歐盟 RoHS 要求

Products is compliance the EU-RoHS request.

料號編碼 Type composition 例 Example

ST	50	J	R010	MG	P10	10
型名 Type	溫度係數 T.C.R	誤差值 Tolerance	電阻值(Ω) Resistance	造型 Forming	端線長 Pitch	線徑 Diameter
	50:±50ppm/°C	F±1%	1M00=1m	MG		
	A0:±100ppm/°C	H±3%	10M0=10m			
	B0:±200ppm/°C	J±5%	R100=0.1			
	C0:±300ppm/°C					

額定 Ratings

Ød (mm)	最大過電流 Max. Current Rating (A)	阻值範圍 Resistance Range (Ω)	誤差值 Tolerance	溫度係數 T.C.R.	使用溫度範圍 Temperature Range
0.8	6	1mΩ~ 10 mΩ	F±1% H±3% J±5%	± 50ppm/°C ±100ppm/°C ±200ppm/°C ±300ppm/°C	-55°C~150°C
1	8	10mΩ~ 200 mΩ			
1.2	10	100mΩ~ 300 mΩ			

■ 額定溫度下降曲線圖 Derating curve

例 Example



■ 試驗條件與方法 The testing method and condition.

試驗項目 Test Items	規格值 Performance Requirements	試驗方法 Test Methods and Standard.(JISC5201-1)
電阻值 Resistance	規定的誤差值內 Within of specified tolerance	測量點從端蓋 10mm Measuring points are distance 10mm from the end cap(4.5)
溫度係數 T.C.R.	規定值內 Within of specified T.C.R.	室溫+100°C Room temperature +100°C(4.8)
短時間過負荷 Short time overload	±2%	No evidence of mechanical damage and after test impedance change ratio
負荷壽命 Load life	±3%	100% rate power load (90min on and 30min off keep the 1,000 Hrs)
耐濕負荷壽命 Load life in humidity	±2%	10% rate power load 40°C, 95% RH for 1,000 hours 1.5h ON / 0.5h OFF cycle(4.24)
焊錫耐熱 Resistance to soldering heat	±1%	260°C ± 5°C for 10 seconds (焊錫槽) 350°C ± 10°C for 3.5 seconds (手焊錫)(4.18)
可焊性 Solderability	Coverage 95%	Temp. of solder 245°C ± 5°C duration of immersion 5 s ± 0.5 s

LOW RESISTANCE RESISTOR

LR

低阻值電阻器

LOW RESISTANCE RESISTOR (LR Type)

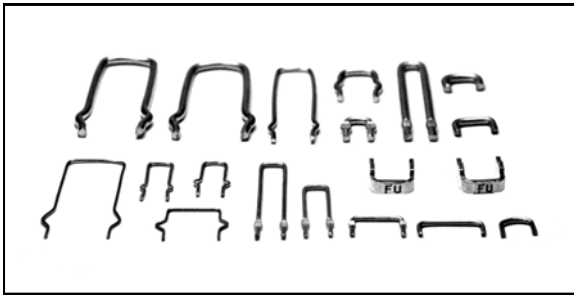

本體顏色 (Body color) :

銀色 (Silver)

結構圖 Construction

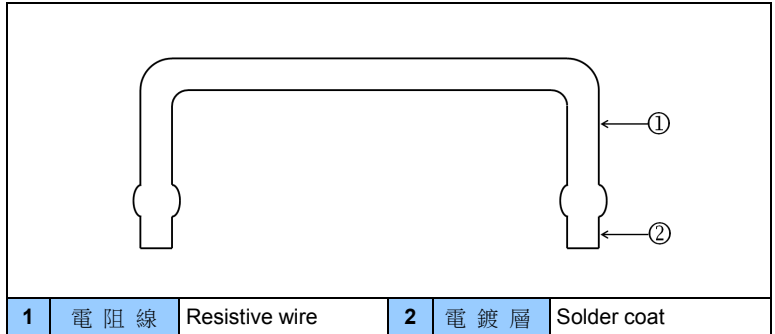

料號編碼 Type composition

例 Example

LR	MC	D08	J	2M50	L050
型名 Type	品名 Size	線徑尺寸 Wire Size	誤差值 Tolerance	電阻值(Ω) Resistance	二次加工 Forming
	MC 錳銅線	D08:Ø0.8	F±1%	1M00=1m	See dimensions
	NC 鎳銅線	D10:Ø1.0	H±3%	10M0=10m	
	NR 鎳鉻線	D12:Ø1.2	J±5%	R100=0.1	
	NH 鍍錫銅線	D20:Ø2.0	K±10%		

特性 Feature

◎尺寸小且重量輕

Small size and light weight.

◎焊錫特性佳

Excellent soldering performance.

◎可依客戶需求製作

Can be produced according to customer's request.

◎產品符合歐盟 RoHS 要求

Products is compliance the EU-RoHS request.

額定 Ratings

Ød (mm)	最大過電流 Max. Current Rating (A)	阻值範圍 Resistance RangeΩ		誤差值 Tolerance	溫度係數 T.C.R.	使用溫度範圍 Temperature Range
		Copper Manganese	Copper Nickel			
0.4	2.0	70mΩ~ 200 mΩ	80mΩ~ 220 mΩ	F±1% H±3% J±5% K±10%	± 50ppm/°C ±100ppm/°C ±200ppm/°C	-55°C~200°C
0.5	2.5	50mΩ~ 150 mΩ	60mΩ~ 165 mΩ			
0.6	3.0	50mΩ~ 100 mΩ	60mΩ~ 110 mΩ			
0.7	4.0	30mΩ~ 70 mΩ	35mΩ~ 75 mΩ			
0.8	4.5	20mΩ~ 50 mΩ	25mΩ~ 55 mΩ			
0.9	5.0	20mΩ~ 40 mΩ	25mΩ~ 40 mΩ			
1	5.5	15mΩ~ 30 mΩ	20mΩ~ 30 mΩ			
1.1	6.0	15mΩ~ 20 mΩ	16mΩ~ 22 mΩ			

Ød (mm)	最大過電流 Max. Current Rating (A)	阻值範圍 Resistance RangeΩ		誤差值 Tolerance	溫度係數 T.C.R.	使用溫度範圍 Temperature Range
		Copper Manganese	Copper Nickel			
1.2	7.0	10mΩ~ 20 mΩ	12mΩ~ 22 mΩ	F±1% G±2% J±5% K±10%	± 50ppm/°C ±100ppm/°C ±200ppm/°C	-55°C~200°C
1.3	7.5	10mΩ~ 20 mΩ	12mΩ~ 22 mΩ			
1.4	8.0	10mΩ~ 20 mΩ	12mΩ~ 22 mΩ			
1.5	9.0	10mΩ~ 20 mΩ	12mΩ~ 22 mΩ			
1.6	9.5	10mΩ~ 15 mΩ	12mΩ~ 16 mΩ			
1.8	11.0	5mΩ~ 10 mΩ	6mΩ~ 11mΩ			
2.0	12.0	5mΩ~ 10 mΩ	6mΩ~ 11mΩ			
2.3	14.0	3mΩ~ 5 mΩ	3mΩ~ 5 mΩ			

■尺寸 Dimension



■額定溫度下降曲線圖 Derating curve

例 Example



■試驗條件與方法 The testing method and condition.

試驗項目 Test Items	規格值 Performance Requirements	試驗方法 Test Methods and Standard.(JISC5201-1)
電阻值 Resistance	規定的誤差值內 Within of specified tolerance	測量點從端蓋 10mm Measuring points are distance 10mm from the end cap(4.5)
溫度係數 T.C.R.	規定值內 Within of specified T.C.R.	室溫+100°C Room temperature +100°C(4.8)
短時間過負荷 Short time overload	±(2%)	No evidence of mechanical damage and after test impedance change ratio
負荷壽命 Load life	±(3%)	100% rate power load (90min on and 30min off keep the 1,000 Hrs)
耐濕負荷壽命 Load life in humidity	±(2%)	10% rate power load 40°C, 95% RH for 1,000 hours 1.5h ON / 0.5h OFF cycle(4.24)
焊錫耐熱 Resistance to soldering heat	±(1%)	260°C ± 5°C for 10 seconds (焊錫槽) 350°C ± 10°C for 3.5 seconds (手焊錫)(4.18)
可焊性 Solderability	Coverage 95%	Temp. of solder 245°C ± 5°C duration of immersion 5 s ± 0.5 s

POWER CHIP RESISTOR

MR

模造電阻器

POWER CHIP RESISTOR (Standard Type)



外觀顏色 (Body Color) :

黑色 (Black)

標示 (Marking) :

文字 (Alphanumeric)

特性 Feature

◎高穩定性皮膜或金屬板抵抗元素

High stability film or metal plate resistance elements.

◎低感值(<50nH).測試頻率 100K Hz

Low inductive(<50nH). Test frequency 100K Hz.

◎提供 20W,30W,35W,50W

Available in 20W,30W,35W,50W.

◎產品符合歐盟 RoHS 要求

Products is compliance the EU-RoHS request.

參考規格 Reference standards

● MIL-STD-202 Method 204

料號編碼 Type composition 例 Example

MR	Q	BO	J	1000	S002	AL
型名 Type	品名 Size	額定功率 Rated power	誤差值 Tolerance	電阻值(Ω) Resistance	二次加工 Forming	端腳 End Feet
	Square	B0:20W	F±1%	0R01=0.01	2 Pin	AL:Aluminum
	Shape	C0:30W	J±5%	R100=0.1		NH:copper terminal
		C5:35W		1R00=1		
		E0:50W		10R0=10		
				1000=100		
				1001=1K		
				1002=10K		

額定 Ratings

Type	Power Rating 1(W)		Voltage Rating 4	Thermal Resistance	阻值範圍 Resistance Range	誤差值 Tolerances	溫度係數 T.C.R.	包裝 Strip (pcs)	
	Heatsink2	Free Air3							
MR-20	20W	2.00W	500V	5.9°C/ W	0.01Ω~ 0.09Ω	±5%	±200ppm/°C	50	
					0.1Ω~ 51KΩ	±1%、±5%	±150ppm/°C		
MR-30	30W	2.25W		4.2°C/ W	0.01Ω~ 0.09Ω	±5%	±200ppm/°C		
					0.1Ω~ 51KΩ	±1%、±5%	±150ppm/°C		
MR-35	35W	2.25W		3.3°C/ W	3.3°C/ W	0.01Ω~ 0.09Ω	±5%		±200ppm/°C
						0.1Ω~ 51KΩ	±1%、±5%		±150ppm/°C
MR-50	50W	2.50W		2.3°C/ W	2.3°C/ W	0.01Ω~ 0.09Ω	±5%		±200ppm/°C
						0.1Ω~ 51KΩ	±1%、±5%		±150ppm/°C

結構圖 Construction



1	散熱片	Flange	Aluminum alloy
2	基板	Substrate	Alumina 99%
3	阻抗材質	Resistance	RuO2 or metal plate
4	引線	Lead terminal	Copper alloy (plated solder)
5	壓模樹脂	Molded resin	Non-flam ability rubber
6	接點	Junction part	Welding with high frequency

外型尺寸 Dimensions (mm)

Rated Power (W)	20	30	35	50
A	10.1±0.2			
B	15±0.2			
C	4.5±0.2			
ØD	3.6±0.1			
E	14.5±1.0			
F	4±0.5			
G	3±0.2			
H	2.75±0.2			
J	0.5±0.1			
K	0.75±0.1			
L	1.4±0.1			
M	16±0.1			
N	1.3±0.1			
P	5.08±0.1			

■ 額定溫度下降曲線圖 Derating curve

例 Example

< 30W



> 30W



■ 試驗條件與方法 The testing method and condition.

試驗項目 Test Items	規格值 Performance Requirements	試驗方法 Test Methods and Standard.(JISC5201-1)
電阻值 Resistance	規定的誤差值內 Within of specified tolerance	測量點從端蓋 10mm Measuring points are distance 10mm from the end cap(4.5)
溫度係數 T.C.R.	規定值內 Within of specified T.C.R.	室溫+100°C Room temperature +100°C(4.8)
熱衝擊 Thermal Shock	±0.3%	Test temp. -55°C ~ +85°C Number of 5 cycles
負荷壽命 Load life	±1%	Rated voltage at 70°C for 1,000 hours 1.5hr ON / 0.5hr OFF Cycles(4.25.1)
耐濕負荷壽命 Load life in humidity	±5%	10% rate power load 40°C, 95% RH for 1,000 hours 1.5h ON / 0.5h OFF cycle(4.24)
耐濕性 Moisture resistance	±1%	65°C, 90~95% RH, 240 小時 65°C, 90~95% RH for 240 hours
焊錫耐熱 Resistance to soldering heat	±0.25%	Temp. of solder 350°C ± 5°C duration of immersion 3.5 s ± 0.5 s
焊錫效果 Solder ability	95 % (min) coverage	Temp. of solder 245°C ± 5°C duration of immersion 3 s ± 0.5 s
耐電壓 Dielectric withstanding voltage	Flash over, burning, insulation damage Should not be observed	V-Block test voltage : DC 2,200V Duration time 60 sec.
絕緣電阻 Insulation resistance	>1,000MΩ	500V 絕緣測試 1 分鐘 500V insulation test 1min.(4.6.1)
振動試驗 Vibration	±(0.25 % + 0.05Ω)	MIL-STD-202 Method 204 Condition D.

APPENDIX (Forming)

Forming Style	Forming Type Name		Dimensions (mm)			
	Rated Power (W)	Type Name	P	H	h	Ød
L Type 	1/4,S1/2,P1	L10(*12.5)	10±1	5.5±1.5	4.0±0.5	0.6±0.05
	1/2,S1,P2 ⁽¹⁾	L12.5(*15)	12.5±2	4.5±1	4.0±0.5	0.6±0.05
	1,S2,P3	L15	15±2	6±1.5	4.0±0.5	0.8±0.05
	2,S3,P5	L20	20±2	10±2	4.0±0.5	0.8±0.05
	3W,S5	L30	30±2	10±2	4.0±0.5	0.8±0.05
C Type 	1/4,S1/2,P1	C10(*12.5)	10±1	5.0±0.5	---	0.6±0.05
	1/2,S1,P2 ⁽¹⁾	C12.5(*15)	12.5±2	5.0±0.5	---	0.6±0.05
	1,S2,P3	C15	15±2	5.0±0.5	---	0.8±0.05
	2,S3,P5	C20	20±2	5.0±0.5	---	0.8±0.05
	3W,S5	C30	30±2	5.0±0.5	---	0.8±0.05
FA5 Type 	1/4,S1/2,P1	---	---	---	---	---
	1/2,S1,P2 ⁽¹⁾	FA5	5±1	5.0±1.0	4.0±0.5	0.6±0.05
	1,S2,P3	FA5	7±2	5.0±1.0	4.0±0.5	0.8±0.05
	2,S3,P5	FA5	8±2	5.0±1.0	4.0±0.5	0.8±0.05
	3W,S5	---	---	---	---	---
FB5 Type 	1/4,S1/2,P1	FB5	5±1	5.0±1.0	4.0±0.5	0.6±0.05
	1/2,S1,P2 ⁽¹⁾	FB5	5±1	5.0±1.0	4.0±0.5	0.6±0.05
	1,S2,P3	FB5	6±2	5.0±1.0	4.0±0.5	0.8±0.05
	2,S3,P5	FB5	8±2	5.0±1.0	4.0±0.5	0.8±0.05
	3W,S5	---	---	---	---	---
FC5 Type 	1/4,S1/2,P1	---	---	---	---	---
	1/2,S1,P2 ⁽¹⁾	FC5	5±1	5.0±1.0	4.0±1.0	0.6±0.05
	1,S2,P3	FC5	6±2	5.0±1.0	4.0±1.0	0.8±0.05
	2,S3,P5	FC5	6±2	5.0±1.0	4.0±1.0	0.8±0.05
	3W,S5	---	---	---	---	---
FD5 Type 	1/4,S1/2,P1	---	---	---	---	---
	1/2,S1,P2 ⁽¹⁾	FD5	5(REF)	3.3±0.5	---	0.6±0.05
	1,S2,P3	FD5	5(REF)	3.3±0.5	---	0.8±0.05
	2,S3,P5	FD5	5(REF)	3.3±0.5	---	0.8±0.05
	3W,S5	---	---	---	---	---
M Type 	1/4,S1/2,P1	M10	10±1	5.0±1.0	4.5±0.5	0.6±0.05
	1/2,S1,P2 ⁽¹⁾	M12.5	12.5±1	8.0±1.0	4.5±0.5	0.6±0.05
	1,S2,P3	M15	15±1.5	6.5±0.5	3.0±0.5	0.8±0.05
	2,S3,P5	M20	20±2.0	6.5±0.5	3.0±0.5	0.8±0.05
	3W,S5	M30	30±2.0	6.5±0.5	3.0±0.5	0.8±0.05

(1) wirewound Type is 0.7mm of terminal size

* forming pitch request please contact sales.

APPENDIX (RG series Type Forming)

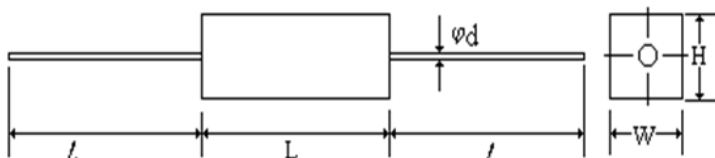
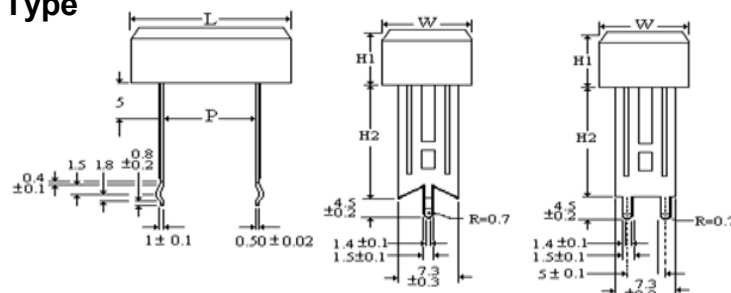
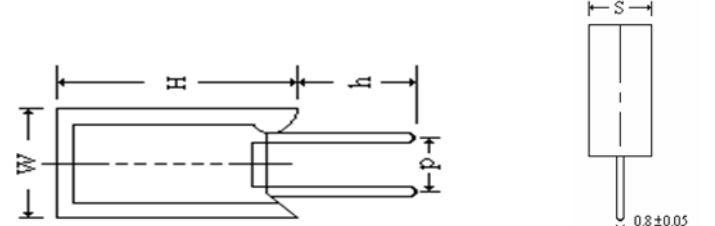
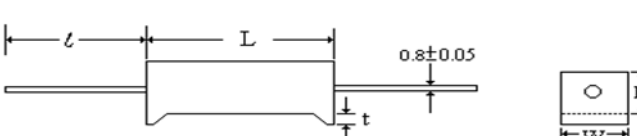
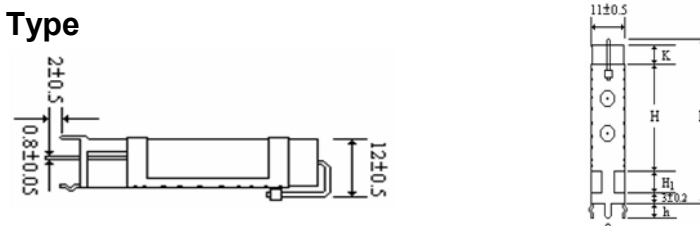
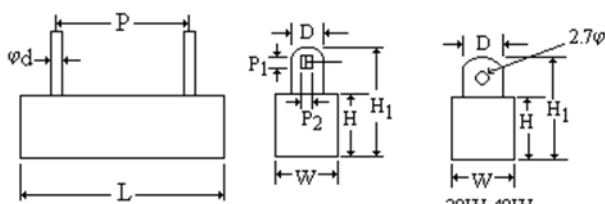
Forming Style	Rated Power (W)	Dimensions (mm)							
		L	W	H	ℓ	∅d			
P Type 	1	14±1	6.5±1	6.5±1	23±3	0.6±0.05			
	2	18±1	7±1	7±1	23±3	0.6±0.05			
	3	22±1.5	8±1	8±1	33±3	0.8±0.05			
	5	22±1.5	10±1	9±1	33±3	0.8±0.05			
	7	35±1.5	10±1	9±1	33±3	0.8±0.05			
	10	48±1.5	10±1	9±1	30±3	0.8±0.05			
	15	48±1.5	12.5±1	11.5±1	30±3	0.8±0.05			
	20~25	60±2	14±1	13.5±1	33±3	0.8±0.05			
Z Type 	Rated Power (W)	W	L	H1	H2	P			
	3	10±1	25±1.5	10±1	10.5±1 (2)	9±1.5			
	5	10±1	28±1.5	10±1		15±1.5			
	7	10±1	36±1.5	10±1		20±1.5			
	10	10±1	48±1.5	10±1		32±1.5			
	15	12.5±1	48±1.5	12±1		32±1.5			
20~25	12.5±1	62.5±1	13±1	15±1	42±1.5				
M Type 	Rated Power (W)	P	W	H	h	S			
	2	5±1	11±1	20±1.5	3.5±1	7±1			
	3	5±1	12±1	25±1.5	3.5±1	8±1			
	5	5±1	13±1	25±1.5	3.5±1	9±1			
	7	5±1	13±1	39±1.5	3.5±1	9±1			
	10	5±1	13±1	51±1.5	3.5±1	9±1			
	10S	7.5±1	16±1	35±1.5	3.5±1	12±1			
20	8±1	20±1	45±1	3.5±1	13±1.5				
T Type 	Rated Power (W)	L	W	H	ℓ	t			
	5	22±1.5	10±1	9±1	33±3	1.5±0.5			
	7	35±1.5	10±1	9±1	33±3	3.0±0.5			
	10	48±1.5	10±1	9±1	30±3	3.0±0.5			
S Type 	Rated Power (W)	L	H	H1	K	h			
	7	46±1.5	28±0.5	7±0.5	6.5±0.5	4±0.3			
10	60±1.5	28±0.5	7±0.5	20±0.5	4±0.3				
H Type 	Rated Power (W)	W	H	L	P	H1	D	P1	P2
	10	10±1	10±1	48±1.5	32±1	18±1	5±0.5	2.5±0.2	1.7±0.2
	15	12.5±1	11.5±1	48±1.5	32±1	21±1	5±0.5	2.5±0.2	1.7±0.2
	20	12.5±1	12.5±1	62±1.5	42±1	24±1	6±0.5	3±0.2	2.5±0.2
	30	19±1	19±1	75±1.5	55±2	31±1	7.5±0.5	-----	-----
40	19±1	19±1	90±1.5	67±2	31±1	7.5±0.5	-----	-----	
(3)									

(2) the terminal length has 10.5 and 25mm choose for client

(3) difference terminal Type please contact sales

APPENDIX (Resistance Tolerance / Basic Value E24 & E96)

■電阻值公差 Resistance tolerance

記號 Symbol	V	L	U	A	B	C	D	F	G	J	K	M
阻值誤差 Resistance tolerance	± 0.005%	± 0.01%	± 0.02%	± 0.05%	± 0.10%	± 0.25%	± 0.50%	± 1%	± 2%	± 5%	± 10%	± 20%

■電阻值有效數字 Significant figures of Nominal resistance

E12	E24	E96			
10	10	100	178	316	562
	11	102	182	324	576
12	12	105	187	332	590
	13	107	191	340	604
15	15	110	196	348	619
	16	113	200	357	634
18	18	115	205	365	649
	20	118	210	374	665
22	22	121	215	383	681
	24	124	221	392	698
27	27	127	226	402	715
	30	130	232	412	732
33	33	133	237	422	750
	36	137	243	432	768
39	39	140	249	442	787
	43	143	255	453	806
47	47	147	261	464	825
	51	150	267	475	845
56	56	154	274	487	866
	62	158	280	499	887
68	68	162	287	511	909
	75	165	294	523	931
82	82	169	301	536	953
	91	174	309	549	976

■電阻值&公差表示 Color code for discrete resistors

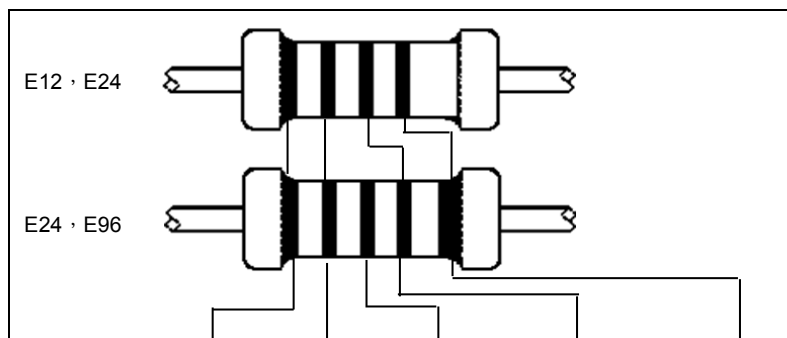

顏色 Color	第一色碼 1st Figure	第二色碼 2nd Figure	第三色碼 3rd Figure	倍率 Multiplier	阻值誤差 Tolerance
黑 : Black	0	0	0	1	L : ± 0.01%
棕 : Brown	1	1	1	10	F : ± 1%
紅 : Red	2	2	2	100	G : ± 2%
橙 : Orange	3	3	3	1,000	U : ± 0.02%
黃 : Yellow	4	4	4	10,000	V : ± 0.005%
綠 : Green	5	5	5	100,000	D : ± 0.5%
藍 : Blue	6	6	6	1,000,000	C : ± 0.25%
紫 : Purple	7	7	7	10,000,000	B : ± 0.1%
灰 : Gray	8	8	8	---	A : ± 0.05%
白 : White	9	9	9	---	---
金 : Gold	---	---	---	0.1	J : ± 5%
銀 : Silver	---	---	---	0.01	K : ± 10%
無 : Plain	---	---	---	---	M : ± 20%

Resistor loading calculation and Surge test method

1. Energy calculation for single pulse

a. Capacitor Energy of RC circuit:

$$E = \frac{1}{2} \times C \times V^2 \quad (C: \text{Capacitance} \cdot V: \text{Voltage})$$

b. For triangle wave



$$f(t) = \frac{I_m}{t_1} (t - t_1) + I_m \quad \text{When } 0 \leq t \leq t_1$$

$$f(t) = 0 \quad \text{When } t_1 < t < T$$

$$I_{RMS} = \sqrt{\frac{1}{2t_1} \int_0^{2t_1} [2f(t)]^2 dt} = \frac{I_m}{\sqrt{6}}$$

$$E = I_{RMS}^2 \times R \times T \quad (I_{RMS}: \text{Root Mean Square current} \cdot T: \text{Loading period} \cdot R: \text{Resistance})$$

Here is the other sample for triangle wave energy calculation.



$$f(t) = \frac{I_m}{T} (t - T) + I_m$$

$$I_{RMS} = \sqrt{\frac{1}{T} \int_0^T [f(t)]^2 dt} = \frac{I_m}{\sqrt{3}}$$

$$E = I_{RMS}^2 \times R \times T \quad (I_{RMS}: \text{Root Mean Square current} \cdot T: \text{Loading period} \cdot R: \text{Resistance})$$

c. For sine wave



$$f(t) = I_m \sin(t)$$

$$I_{RMS} = \sqrt{\frac{1}{T} \int_0^T [f(t)]^2 dt} = \frac{I_m}{\sqrt{2}}$$

$$E = I_{RMS}^2 \times R \times T \quad (I_{RMS}: \text{Root Mean Square current} \cdot T: \text{Loading period} \cdot R: \text{Resistance})$$

d. For rectangle wave



$$f(t) = I_m \quad \text{When } 0 \leq t \leq t_1$$

$$I_{RMS} = \sqrt{\frac{1}{T} \int_0^T [f(t)]^2 dt} = \frac{I_m}{\sqrt{2}}$$

$$E = I_{RMS}^2 \times R \times T \quad (I_{RMS}: \text{Root Mean Square current} \cdot T: \text{Loading period} \cdot R: \text{Resistance})$$

2. Power rate

$$W = \frac{E}{t}$$

Resistor loading calculation and Surge test method

3. Temperature effect: (Follow statement is the example, real de-rating curve and surge curve should follow the spec.)



Figure 1

According Figure 1, the ambient temperature will affect the loading ability. The temperature factor can be presented as:

$$\tau_t = \frac{155 - 25}{155 - T} \quad (T: \text{Application ambient temperature})$$

4. Loading ratio:

a. For continues loading:

$$\text{Ratio} = \frac{W}{W_{Rate}} \times \tau_t \times 100\% \quad (W_{Rate}: \text{Rated power})$$

b. For impulse loading:

First we need to multiply temperature factor to get the modified power rate.

$$W_m = W \times \tau_t \quad (W_m: \text{Modified power rate})$$

After we got W_m , we can find out the capability loading time on Figure 2.

$$\text{Ratio} = \frac{t}{t_c} \times 100\% \quad (t_c: \text{Capability loading time})$$

5. Judgment method

Because of the ambient temperature variation would affect the resistor loading ability; therefore we would recommend the loading ratio should smaller than 80%.

6. Surge test circuit



Test method should follow the JISC5201 standard. After 10000 cycle test, the resistor can not show any damage and resistance variation shall smaller than 5%.

Figure 2



NOTE

X-ON Electronics

Largest Supplier of Electrical and Electronic Components

Click to view similar products for [Thick Film Resistors - SMD category](#):

Click to view products by [Futaba manufacturer](#):

Other Similar products are found below :

[CR-05FL7--150R](#) [CR-05FL7--19K6](#) [CR-05FL7--243R](#) [CR-05FL7--40K2](#) [CR-05FL7--698K](#) [CR-12FP4--324R](#) [CR-12JP4--680R](#)
[M55342K06B1E78RS3](#) [M55342K06B6E19RWL](#) [M55342K06B6E81RS3](#) [M55342M05B200DRWB](#) [M55342M06B4K70MS3](#) [MC0603-511-](#)
[JTW](#) [742C083750JTR](#) [MCR01MZPF1202](#) [MCR01MZPF1601](#) [MCR01MZPF1800](#) [MCR01MZPF6201](#) [MCR01MZPF9102](#) [MCR01MZPJ113](#)
[MCR01MZPJ121](#) [MCR01MZPJ125](#) [MCR01MZPJ751](#) [MCR03EZHZ103](#) [MCR03EZPF2004](#) [MCR03EZPJ270](#) [MCR03EZPJ821](#)
[MCR10EZPF1102](#) [MCR18EZPJ330](#) [RC0603F1473CS](#) [RC0603F150CS](#) [RC1005F1152CS](#) [RC1005F1182CS](#) [RC1005F1372CS](#)
[RC1005F183CS](#) [RC1005F1911CS](#) [RC1005F1912CS](#) [RC1005F203CS](#) [RC1005F2052CS](#) [RC1005F241CS](#) [RC1005F2431CS](#)
[RC1005F3011CS](#) [RC1005F303CS](#) [RC1005F4321CS](#) [RC1005F4642CS](#) [RC1005F471CS](#) [RC1005F4751CS](#) [RC1005F5621CS](#)
[RC1005F6041CS](#) [RC1005J106CS](#)