

# COMPANY HISTORY

|                       |   |
|-----------------------|---|
| 1973,3 月              | 與日本福島雙羽簽訂技術合作合約   |
| <b>January 1973</b>   | <b>Signed technical cooperation agreement with Fukushima Futaba in Japan.</b>       |
| 1973,10 月             | 台灣雙羽電機股份有限公司正式成立  |
| <b>October 1973</b>   | <b>Founded as Futaba Electric Co., Ltd.</b>   |
| 1974, 9 月             | 開始量產氧化金屬膜電阻器  |
| <b>November 1999</b>  | <b>Mass production of Metal Oxide Film Resistor.</b>                                |
| 1997,6 月              | 成立大陸廠,雙羽電子(深圳)有限公司  |
| <b>June 1997</b>      | <b>Established Shenzhen plant in China.</b>   |
| 1997,10 月             | 台灣廠取得 ISO 9000 : 1994 認證  |
| <b>October 1997</b>   | <b>Futaba Taiwan HQ achieved ISO 9000 : 1994 certification.</b>                     |
| 1998,1 月              | 開始量產高阻值金屬釉電阻器   |
| <b>January 1998</b>   | <b>Mass production of High Meg Metal Glaze Resistor.</b>                            |
| 1999,3 月              | 大陸廠(深圳)取得 ISO 9000 : 1994 認證  |
| <b>March 1999</b>     | <b>Shenzhen plant achieved ISO 9000: 1994 certification.</b>                        |
| 1999,11 月             | 成立大陸廠: 雙葉電子廠  |
| <b>November 1999</b>  | <b>Established Shuangya Electronics Co. in China.</b>                               |
| 2002,8 月              | 台灣廠取得 ISO 9001 : 2000 改版認證  |
| <b>August 2002</b>    | <b>Futaba Taiwan HQ achieved ISO 9001: 2000 certification.</b>                      |
| 2003.1 月              | 大陸廠(深圳)取得 ISO 9001 : 2000 改版認證  |
| <b>January, 2003</b>  | <b>Shenzhen plant achieved ISO 9001: 2000 certification.</b>                        |
| 2003.1 月              | 導入無鉛產品; 導入 RoHS   |
| <b>January 2003</b>   | <b>Implemented Lead-Free products.</b>  |
| 2003.4 月              | 台灣廠取得 SONY 綠色夥伴認證   |
| <b>April 2003</b>     | <b>Futaba Taiwan HQ achieved SONY green partner certification.</b>                  |
| 2003,9 月              | 成立大陸廠,雙羽電子(蘇州)有限公司  |
| <b>September 2003</b> | <b>Established Suzhou plant in China.</b>   |
| 2004,8 月              | 大陸廠(蘇州)取得 ISO 9001 : 2004 認證  |
| <b>August 2004</b>    | <b>Suzhou plant achieved ISO 9001: 2004 certification.</b>                          |
| 2005,12 月             | 大陸廠(深圳)取得 ISO 14001 : 2004 認證   |
| <b>December 2005</b>  | <b>Shenzhen plant achieved ISO 14001: 2004 certification.</b>                       |
| 2006,3 月              | 大陸廠(蘇州)取得 ISO 14001 : 2004 認證   |
| <b>March 2006</b>     | <b>Suzhou plant achieved ISO 14001: 2004 certification.</b>                         |
| 2008,8 月              | 導入無鹵產品  |
| <b>August 2008</b>    | <b>Implemented Halogen-Free products.</b>   |
| 2009,8 月              | 台灣及大陸廠均取得 ISO 9001 : 2008 認證(台灣廠、深圳廠、雙葉廠、蘇州廠)                                       |
| <b>August 2009</b>    | <b>Taiwan, Shenzhen, Shuangya and Suzhou achieved ISO 9001: 2008 certification.</b> |
| 2010, 2 月             | 大陸廠(蘇州)取得 TS 16949 : 2009 認證  |
| <b>February 2010</b>  | <b>Suzhou plant achieved TS 16949: 2009 certification.</b>                          |
| 2012, 7 月             | 大陸廠(雙葉)更名為富羽雙華電阻材料有限公司  |
| <b>July 2012</b>      | <b>Shuangya renamed to Futaba Electronics Co., Ltd.</b>                             |

# INDEX

## 固定電阻器 Fixed Resistors

| 品類 Type           | 產品名稱 Product Name   | 品名 Type                                       | 頁 Page            |
|-------------------|---------------------|---|-------------------|
| Film              | 氧化金屬膜電阻器            | METAL OXIDE FILM RESISTOR                     | RS 4 • 5          |
|                   | 金屬皮膜固定電阻器           | FIXED METAL FILM RESISTOR                     | RN 6 • 7          |
|                   | 金屬皮膜精密電阻器           | METAL FILM PRECISION RESISTOR                 | RP 8 • 9          |
| High              | 金屬釉電阻器              | METAL GLAZE RESISTOR                          | RM 10 • 11        |
|                   | 耐突波電阻器              | SURGE RESISTOR                                | RV 12 • 13        |
|                   | 高阻值電阻器              | HIGH RESISTANCE RESISTOR                      | RR 14 • 15        |
| Fusing            | 保險絲電阻器              | FUSIBLE RESISTOR                              | RF 16 • 17        |
|                   | 電流式保險絲電阻器           | RATED CURRENT FUSIBLE RESISTOR                | RFA 18 • 19       |
|                   | 高能量突波繞線保險絲電阻器       | HEAT ENERGY SURGE WIRE WOUND FUSIBLE RESISTOR | WF 20 • 21        |
|                   | 可復式水泥繞線電阻組合溫度保險絲電阻器 | NON-SMOKE THERMAL FUSE RESISTOR               | RFT 22 • 23       |
|                   | 防爆保險絲電阻器            | ANTI-BURST FUSIBLE RESISTOR                   | RFB / RFF 24 • 25 |
| Wire              | 繞線電阻器               | WIRE WOUND RESISTOR                           | RW 26 • 27        |
| Wound             | 無感電阻器               | NON INDUCTIVE RESISTOR                        | NW/NM/NV 28 • 29  |
| Ceramic<br>Cased  | 金屬板電阻器              | METAL PLATE CEMENT RESISTOR                   | MPC / MPH 30 • 31 |
|                   | 薄型金屬板電阻器            | METAL PLATE CEMENT RESISTOR                   | MPM 32 • 33       |
|                   | 薄型電阻器               | METAL PLATE CEMENT RESISTOR                   | MPT / MPQ 34 • 35 |
|                   | 水泥電阻器               | CEMENT RESISTOR                               | RG 36 • 37        |
|                   | 高絕緣水泥電阻器            | CEMENT RESISTOR                               | RGK 38 • 39       |
|                   | 電流偵測電阻器             | CURRENT SENSOR RESISTOR                       | RGC 40 • 41       |
|                   | 高脈衝繞線電阻器(可加溫度保險絲)   | HIGH PULSE WIRE WOUND RESISTOR                | HVW 42 • 43       |
| Aluminum<br>Cased | 黃金鋁殼電阻器             | ALUMINUM CASED POWER RESISTOR                 | GR 44 • 45        |
|                   | 薄型鋁殼電阻器             | FLAT TYPE METAL CLAD WIRE WOUND RESISTOR      | GH 46 • 47        |
|                   | 方型鋁殼電阻器             | SQUARE SHAPE ALUMINUM SHELL RESISTOR          | RA 48 • 49        |
|                   | 船型鋁殼電阻器             | TRAPEZOID ALUMINUM SHELL RESISTOR             | RAMH 50 • 51      |
| High Power        | 大功率電阻器              | POWER WIRE WOUND RESISTOR                     | RQ 52 • 53        |
| Other             | 塗裝絕緣型 0Ω電阻器         | COAT-INSULATED ZERO OHM RESISTOR              | RZ 54 • 55        |
|                   | 低阻值電阻器              | LOW RESISTANCE RESISTOR                       | ST 56 • 57        |
|                   | 低阻值電阻器              | LOW RESISTANCE RESISTOR                       | LR 58 • 59        |
|                   | 模造電阻器               | POWER CHIP RESISTOR                           | MR 60 • 61        |

## 附錄 APPENDIX

| 造型 FORMING  |  | 頁 Page  |
|---|--|---------|
| TAPING(A52/A64/A73) • L TYPE • C TYPE • FA5 TYPE • FB5 TYPE • FC5 TYPE • M TYPE • D TYPE • Y TYPE • YT TYPE • FT TYPE |  | 62 • 63 |
| RG SERIES TYPE  | P TYPE • Z TYPE • M TYPE • S TYPE • H TYPE | 64      |
| RESISTANCE TOLERANCE / BASIC VALUE E24 & E96  |  | 65      |
| RESISTOR LOADING CALCULATION AND SURGE TEST METHOD  |  | 66 • 69 |

| 額定電力 Power Rating (W) |     |     |   |   |   |    | 電阻公差 Resistance Tolerance |        |       |       |     |     |     | 歐洲<br>RoHS | 中國<br>RoHS | 品名 Type | 頁 Page       |       |
|-----------------------|-----|-----|---|---|---|----|---------------------------|--------|-------|-------|-----|-----|-----|------------|------------|---------|--------------|-------|
| <1/4                  | 1/4 | 1/2 | 1 | 2 | 3 | >3 | ±0.01%                    | ±0.05% | ±0.1% | ±0.5% | ±1% | ±2% | ±5% |            |            |         |              | >±5%  |
|                       |     |     |   |   |   |    |                           |        |       |       |     | ⊙   | ⊙   |            | ●          | ○       | RS           | 4・5   |
|                       |     |     |   |   |   |    | ⊙                         | ⊙      | ⊙     | ⊙     | ⊙   | ⊙   | ⊙   |            | ●          |         | RN           | 6・7   |
|                       |     |     |   |   |   |    | ⊙                         | ⊙      | ⊙     | ⊙     |     |     |     |            | ●          |         | RP           | 8・9   |
|                       |     |     |   |   |   |    |                           |        | ⊙     | ⊙     | ⊙   | ⊙   |     |            | ●          | ○       | RM           | 10・11 |
|                       |     |     |   |   |   |    |                           |        |       | ⊙     | ⊙   | ⊙   |     |            | ●          |         | RV           | 12・13 |
|                       |     |     |   |   |   |    |                           |        |       | ⊙     | ⊙   | ⊙   |     |            | ●          |         | RR           | 14・15 |
|                       |     |     |   |   |   |    |                           |        |       |       |     |     | ⊙   |            | ●          |         | RF           | 16・17 |
|                       |     |     |   |   |   |    |                           |        |       |       |     |     |     |            | ●          |         | RFA          | 18・19 |
|                       |     |     |   |   |   |    |                           |        |       |       |     |     | ⊙   |            | ●          |         | WF           | 20・21 |
|                       |     |     |   |   |   |    |                           |        |       |       |     |     | ⊙   |            | ●          |         | RFT          | 22・23 |
|                       |     |     |   |   |   |    |                           |        |       |       |     |     | ⊙   |            | ●          |         | RFB / RFF    | 24・25 |
|                       |     |     |   |   |   |    |                           |        | Δ     | ⊙     | ⊙   | ⊙   | ⊙   |            | ●          | ○       | RW           | 26・27 |
|                       |     |     |   |   |   |    |                           |        |       |       |     | ⊙   | ⊙   |            | ●          | ○       | NW / NM / NV | 28・29 |
|                       |     |     |   |   |   |    |                           |        | Δ     | ⊙     | ⊙   | ⊙   | ⊙   |            | ●          | ○       | MPC / MPH    | 30・31 |
|                       |     |     |   |   |   |    |                           |        |       |       |     |     | ⊙   | ⊙          | ●          | ○       | MPM          | 32・33 |
|                       |     |     |   |   |   |    |                           |        |       | ⊙     | ⊙   | ⊙   | ⊙   |            | ●          | ○       | MPT / MPQ    | 34・35 |
|                       |     |     |   |   |   |    |                           |        |       | ⊙     | ⊙   | ⊙   |     |            | ●          |         | RG           | 36・37 |
|                       |     |     |   |   |   |    |                           |        |       | Δ     | Δ   | ⊙   |     |            | ●          |         | RGK          | 38・39 |
|                       |     |     |   |   |   |    |                           |        | Δ     | ⊙     | ⊙   | ⊙   |     |            | ●          |         | RGC          | 40・41 |
|                       |     |     |   |   |   |    |                           |        |       |       |     |     | ⊙   |            | ●          |         | HVW          | 42・43 |
|                       |     |     |   |   |   |    |                           |        |       | ⊙     | ⊙   | ⊙   |     |            | ●          |         | GR           | 44・45 |
|                       |     |     |   |   |   |    |                           |        |       |       |     |     | ⊙   |            | ●          |         | GH           | 46・47 |
|                       |     |     |   |   |   |    |                           |        |       |       |     |     | ⊙   |            | ●          |         | RA           | 48・49 |
|                       |     |     |   |   |   |    |                           |        |       |       |     |     | ⊙   |            | ●          |         | RAMH         | 50・51 |
|                       |     |     |   |   |   |    |                           |        |       | Δ     | ⊙   | ⊙   |     |            | ●          |         | RQ           | 52・53 |
|                       |     |     |   |   |   |    |                           |        |       |       |     |     |     |            | ●          |         | RZ           | 54・55 |
|                       |     |     |   |   |   |    |                           |        |       | ⊙     | ⊙   | ⊙   |     |            | ●          |         | ST           | 56・57 |
|                       |     |     |   |   |   |    |                           |        |       | ⊙     | ⊙   | ⊙   |     |            | ●          |         | LR           | 58・59 |
|                       |     |     |   |   |   |    |                           |        | Δ     | ⊙     | ⊙   | ⊙   |     |            | ●          |         | MR           | 60・61 |

NOTE:Δ Please contact our sales

| 額定電力 Power Rating (W)                              | 頁 Page |
|--|--------|
| AVAILABLE : 1/4W~5W                                | 62・63  |
| AVAILABLE : 1W~40W                                 | 64     |
| RESISTANCE TOLERANCE / BASIC VALUE E24 & E96       | 65     |
| RESISTOR LOADING CALCULATION AND SURGE TEST METHOD | 66・69  |

# POWER TYPE

**RSU** 氧化金屬膜電阻器  
METAL OXIDE FILM RESISTOR (Standard Type)

**RSS** 小型氧化金屬膜電阻器  
METAL OXIDE FILM RESISTOR (Small Type)

**RSP** 超小型氧化金屬膜電阻器  
METAL OXIDE FILM RESISTOR (Super Small Type)



塗裝顏色 (Coating Color) :

標準品 (Standard Type) 灰色 (Gray)

小型品 (Small Type) 粉紅色 (Pink)

超小型品 (Super Small Type) 粉紅色 (Pink)

標示 (Marking) :

色碼 (Color Code) (1/4W、S1/2W)

文字 (Alphanumeric) (1/2W~S5W)

## 特性 Feature

◎ 使用不燃性塗料，具不燃與絕緣之安全特性(UL94 V-0)

Flameproof and insulating coating designed to assure safe usage by special non-flammable silicon-base.

(Equivalent to UL94 V-0)

◎ 小型化能高密度插裝

Small size are good for high density application.

◎ 高信賴性

High reliability.

◎ 耐熱性佳,表面溫昇低

High thermal stability and low surface temperature rise.

◎ 產品符合歐盟 RoHS 要求

Products is compliance the EU-RoHS request.

## 參考規格 Reference standards

● JIS C 5201-1

## 額定 Ratings

| Rated Power (W) | 阻值範圍 Resistance Range (Ω) |            |            | 最高使用電壓 Max. Working Voltage | 最高過負荷電壓 Max. Overload Voltage | 耐電壓 Dielectric Withstanding Voltage | 溫度係數 T.C.R.         | 包裝 Taping/Ammo, Forming/Bulk pack (pcs) |      |     |      |      |      |
|-----------------|---------------------------|------------|------------|-----------------------------|-------------------------------|-------------------------------------|---------------------|---|------|-----|------|------|------|
|                 | F±1% (E96)                | G±2% (E24) | J±5% (E24) |                             |                               |                                     |                     | A52                                     | A64  | A73 | FT   | YT   | L    |
| 1/4, S1/2, P1   | 0.1 ~ 910K                |            |            | 250V                        | 500V                          | 250V                                | F±1%:<br>±100ppm/°C | 2500                                    | —    | —   | 2000 | —    | 2500 |
| 1/2, S1, P2     | 0.1 ~ 33K                 | 0.1 ~ 470K |            |                             |                               |                                     |                     | 2000                                    | —    | —   | 2000 | 2000 | 2500 |
| 1, S2, P3       | 0.1 ~ 33K                 | 0.1 ~ 750K |            | 350V                        | 700V                          | 350V                                | G±2%:<br>±200ppm/°C | 1000                                    | 1000 | —   | 1000 | 1000 | 1000 |
| 2, S3, P5       | 0.1 ~ 33K                 | 0.1 ~ 330K |            |                             |                               |                                     |                     | 500                                     | 500  | 500 | —    | 1000 | 1000 |
| 3, S5           | 0.1 ~ 33K                 | 0.1 ~ 100K |            | 500V                        | 1000V                         | 500V                                | ±350ppm/°C          | —                                       | —    | —   | —    | —    | 200  |

## 結構圖 Construction



|   |     |                        |   |      |                       |
|---|-----|------------------------|---|------|-----------------------|
| 1 | 端子線 | Lead wire              | 5 | 導電皮膜 | Conductive film       |
| 2 | 瓷棒  | Ceramic base           | 6 | 標示   | Marking or color code |
| 3 | 鐵帽  | Cap                    |   |      |                       |
| 4 | 切割線 | Helical cutting groove | 7 | 絕緣塗料 | Insulation coat       |

## 外型尺寸 Dimensions

| Rated Power (W) | Dimensions (mm) |         |         |                         |      | Weight (g) (1000pcs) |
|-----------------|-----------------|---------|---------|-------------------------|------|----------------------|
|                 | L               | L1 Max. | D       | Ød                      | ℓ    |                      |
| 1/4, S1/2, P1   | 6.0±0.5         | 7       | 2.4±0.3 | 0.6±0.05<br>P2:0.7±0.05 | 28±2 | 210                  |
| 1/2, S1, P2     | 9±0.5           | 11      | 3.0±0.5 |                         | 28±3 | 285                  |
| 1, S2, P3       | 12±1            | 15      | 4.0±0.5 | 0.8±0.05                | 38±3 | 728                  |
| 2, S3, P5       | 16±1            | 18      | 5.5±0.5 |                         |      | 1380                 |
| 3, S5           | 25±1            | 28      | 8.5±0.5 |                         |      | 3768                 |

## 料號編碼 Type composition

例 Example

| RS      | U              | 14               | J             | R100              | A520            | NH              |
|---------|----------------|------------------|---------------|-------------------|-----------------|-----------------|
| 型名 Type | 品名 Size        | 額定功率 Rated Power | 誤差值 Tolerance | 電阻值(Ω) Resistance | 二次加工 Forming    | 端子線 Lead Wire   |
|         | U: Standard    | 14:1/4W          | F±1%          | R100=0.1          | See table below | 熱鍍線 Heat plated |
|         | S: Small       | 12:1/2W          | G±2%          | 1R00=1            |                 |                 |
|         | P: Super small | 01:1W            | J±5%          | 10R0=10           |                 |                 |
|         |                | 02:2W            |               | 1000=100          |                 |                 |
|         |                | 03:3W            |               | 1001=1K           |                 |                 |
|         |                | 05:5W            |               | 1002=10K          |                 |                 |
|         |                |                  |               | 1003=100K         |                 |                 |

■ 額定溫度下降曲線圖 Derating curve

例 Example

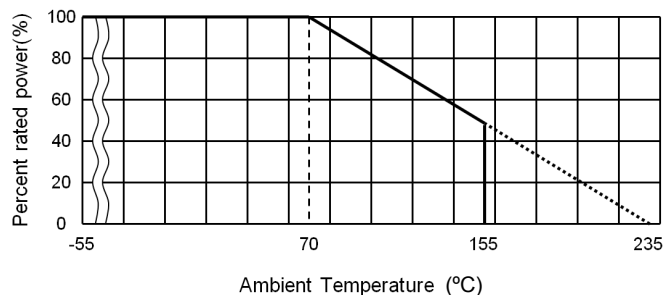

■ 表面溫度上升

Surface Temperature Rise Vs. Loaded Power

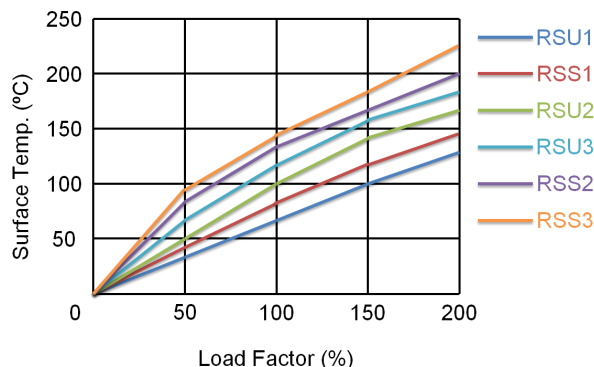

■ 二次加工對應表 Taping & Forming Matrix

| Rated Power (W) | Taping |     |     | Radial Taping |    | L Forming |       |     |     |     | C Forming |     |     |     | F Forming |     |     |     | M Forming |     |     | D Forming |     |     |
|-----------------|--------|-----|-----|---------------|----|-----------|-------|-----|-----|-----|-----------|-----|-----|-----|-----------|-----|-----|-----|-----------|-----|-----|-----------|-----|-----|
|                 | A52    | A64 | A73 | FT            | YT | L10       | L12.5 | L15 | L20 | L30 | C12.5     | C15 | C20 | C30 | FA5       | FB5 | FC5 | FD5 | M12.5     | M15 | M20 | D12.5     | D15 | D20 |
| 1/4,S1/2,P1     | ○      | -   | -   | ○             | -  | ○         | -     | -   | -   | -   | -         | -   | -   | -   | -         | ○   | -   | -   | -         | -   | -   | -         | -   | -   |
| 1/2,S1,P2       | ○      | -   | -   | ○             | ○  | -         | ○     | -   | -   | -   | ○         | -   | -   | -   | ○         | ○   | ○   | ○   | ○         | -   | -   | -         | ○   | -   |
| 1,S2,P3         | ○      | -   | -   | ○             | ○  | -         | -     | ○   | -   | -   | -         | ○   | -   | -   | ○         | ○   | ○   | ○   | -         | ○   | -   | -         | -   | ○   |
| 2,S3,P5         | ○      | ○   | ○   | -             | ○  | -         | -     | -   | ○   | -   | -         | -   | ○   | -   | ○         | ○   | ○   | ○   | -         | -   | ○   | -         | -   | ○   |
| 3,S5            | -      | -   | -   | -             | -  | -         | -     | -   | -   | ○   | -         | -   | -   | ○   | -         | -   | -   | -   | -         | -   | -   | -         | -   | -   |

■ 試驗條件與方法 The testing method and condition.

| 試驗項目<br>Test Items                   | 規格值<br>Performance Requirements          | 試驗方法<br>Test Methods and Standard.(JISC5201-1)  |
|--------------------------------------|--|---|
| 電阻值<br>Resistance                    | 規定的誤差值內<br>Within of specified tolerance | 測量點從端蓋 10mm<br>Measuring points are distance 10mm from the end cap(4.5)                           |
| 溫度係數<br>T.C.R.                       | 規定值內<br>Within of specified T.C.R.       | 室溫+100°C<br>Room temperature +100°C(4.8)  |
| 短時間過負荷<br>Short time overload        | ±(1%+0.05Ω)                              | 6.25 倍額定功率，5 秒<br>6.25 times the rated power for 5 seconds(4.13)                                  |
| 負荷壽命<br>Load life                    | ±(5%+0.1Ω)                               | Rated voltage at 70°C for 1,000 hours<br>1.5hr ON / 0.5hr OFF Cycles(4.25.1)                      |
| 耐濕負荷壽命<br>Load life in humidity      | ±(5%+0.1Ω)                               | 10% rate power load<br>40°C, 95% RH for 1,000 hours<br>1.5h ON / 0.5h OFF cycle(4.24)             |
| 耐濕性<br>Moisture resistance           | ±(1%+0.05Ω)                              | 40°C，95% RH，240 小時<br>40°C, 95% RH for 240 hours  |
| 溫度循環<br>Temperature cycle            | ±(1%+0.05Ω)                              | 5 cycles for -25°C (30min) : room temp. (30min)<br>~ +85°C (30min) room temp. (30min)(4.19)(4.19) |
| 斷續過負荷<br>Intermittent overload       | ±(5%+0.1Ω)                               | Applicable more than 100Ω : Rated voltage ×3<br>1s ON / 25s OFF , 10,000 cycles(4.13)             |
| 焊錫耐熱<br>Resistance to soldering heat | ±(1%+0.05Ω)                              | 260°C ± 5°C for 10 seconds (焊錫槽)<br>350°C ± 10°C for 3.5 seconds (手焊錫)(4.18)                      |
| 絕緣電阻<br>Insulation resistance        | >1,000MΩ                                 | 500V 絕緣測試 1 分鐘<br>500V insulation test 1min.(4.6.1)   |

# POWER TYPE

**RNU** 金屬皮膜固定電阻器  
FIXED METAL FILM RESISTOR (Standard Type)

**RNS** 小型金屬皮膜固定電阻器  
FIXED METAL FILM RESISTOR (Small Type)



## 結構圖 Construction



|   |     |                        |   |      |                       |
|---|-----|------------------------|---|------|-----------------------|
| 1 | 端子線 | Lead wire              | 5 | 導電皮膜 | Conductive film       |
| 2 | 瓷棒  | Ceramic base           | 6 | 標示   | Marking or color code |
| 3 | 鐵帽  | Cap                    |   |      |                       |
| 4 | 切割線 | Helical cutting groove | 7 | 絕緣塗料 | Insulation coat       |

塗裝顏色 (Coating Color) :

S1/2W 深藍色 Dark blue

others 淺藍色 Light blue,

標示 (Marking) :

色碼 (Color Code) (1/8,S1/4,1/4,S1/2)

文字 (Alphanumeric) ( $\geq 1/2W$ )

## 外型尺寸 Dimensions

| Rated Power (W) | Dimensions (mm) |         |         |           |      | Weight (g)<br>(1000pcs) |
|-----------------|-----------------|---------|---------|-----------|------|-------------------------|
|                 | L               | L1 Max. | D       | Ød        | ℓ    |                         |
| 1/8,S1/4        | 3.5±0.5         | 5       | 1.7±0.3 | 0.45±0.05 | 27±3 | 110                     |
| 1/6             | 3.5±0.5         | 5       | 1.7±0.4 | 0.45±0.05 | 27±3 | 110                     |
| 1/4,S1/2        | 6.0±0.5         | 7       | 2.3±0.3 | 0.52±0.05 | 27±3 | 210                     |
| 1/2,S1          | 9±1             | 11      | 3.2±0.5 | 0.56±0.05 | 27±3 | 285                     |
| 1,S2            | 12±1            | 15      | 4.0±0.5 | 0.8±0.05  | 38±3 | 728                     |
| 2,S3            | 16±1            | 18      | 5.5±0.5 | 0.8±0.05  | 38±3 | 1380                    |

## 特性 Feature

◎高精密低溫度係數金屬膜電阻器

High precision and low T.C.R. of metal film resistor.

◎長期穩定性佳

Excellent stability for long time service.

◎可自動插件

Automatic insertion is applicable.

◎產品符合歐盟 RoHS 要求

Products is compliance the EU-RoHS request.

## 料號編碼 Type composition

例 Example

| RN         | U           | 14                  | J                | 10R0                 | A520               | NH                 |
|------------|-------------|---------------------|------------------|----------------------|--------------------|--------------------|
| 型名<br>Type | 品名<br>Size  | 額定功率<br>Rated Power | 誤差值<br>Tolerance | 電阻值(Ω)<br>Resistance | 二次加工<br>Forming    | 端子線<br>Lead Wire   |
|            | U: Standard | 18:1/8W             | F±1%             | 10R0=10              | See table<br>below | 熱鍍線<br>Heat plated |
|            | S: Small    | 14:1/4W             | G±2%             | 1000=100             |                    |                    |
|            |             | 12:1/2W             | J±5%             | 1001=1K              |                    |                    |
|            |             | 01:1W               | J±5%             | 1002=10K             |                    |                    |
|            |             | 02:2W               |                  | 1003=100K            |                    |                    |
|            |             | 03:3W               |                  | 1004=1M              |                    |                    |

## 參考規格 Reference standards

● JIS C 5201-1

## 額定 Ratings

| Rated Power (W)  | 阻值範圍 Resistance Range (Ω) |            |            | 最高使用電壓 Max. Working Voltage | 最高過負荷電壓 Max. Overload Voltage | 耐電壓 Dielectric Withstanding Voltage | 溫度係數 T.C.R. | 包裝 Taping/Ammo,Forming/Bulk pack (pcs) |     |      |      |      |      |
|------------------|---------------------------|------------|------------|-----------------------------|-------------------------------|-------------------------------------|-------------|--|-----|------|------|------|------|
|                  | F±1% (E96)                | G±2% (E24) | J±5% (E24) |                             |                               |                                     |             | A52                                    | A64 | A73  | FT   | YT   | L    |
| 1/8,1/6,<br>S1/4 | 10Ω~1M                    |            |            | 200V                        | 400V                          | 300V                                | ±100ppm/°C  | 5000                                   | -   | -    | -    | -    | -    |
| 1/4,S1/2         | 10Ω~2.2M                  |            |            | 250V                        | 500V                          | 500V                                |             | 2500                                   | -   | -    | 2000 | -    | 2500 |
| 1/2,S1           | 10Ω~5.1M                  |            |            | 350V                        | 700V                          |                                     |             | 2000                                   | -   | -    | 2000 | 2000 | 2500 |
| 1,S2             |                           |            |            | 1000                        |                               |                                     |             | 1000                                   | -   | 1000 | 1000 | 1000 |      |
| 2,S3             |                           |            |            | 500                         |                               |                                     |             | 500                                    | 500 | -    | 1000 | 1000 |      |

**■ 額定溫度下降曲線圖 Derating curve**

例 Example

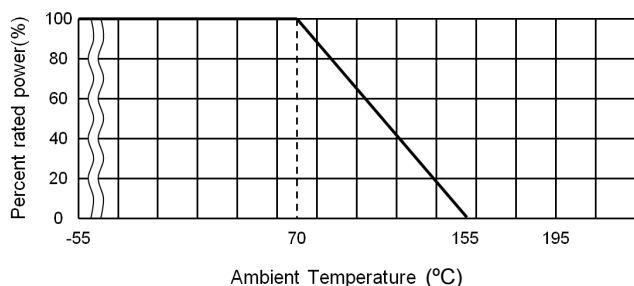

**■ 二次加工對應表 Taping & Forming Matrix**

| Rated Power (W) | Taping |     |     | Radial Taping |    | L Forming |       |     |     |     | C Forming |     |     |     | F Forming |     |     |     | M Forming |     |     | D Forming |     |     |   |
|-----------------|--------|-----|-----|---------------|----|-----------|-------|-----|-----|-----|-----------|-----|-----|-----|-----------|-----|-----|-----|-----------|-----|-----|-----------|-----|-----|---|
|                 | A26    | A52 | A64 | FT            | YT | L10       | L12.5 | L15 | L20 | L30 | C12.5     | C15 | C20 | C30 | FA5       | FB5 | FC5 | FD5 | M12.5     | M15 | M20 | D12.5     | D15 | D20 |   |
| 1/8,1/6         | ○      | -   | -   | -             | -  | -         | -     | -   | -   | -   | -         | -   | -   | -   | -         | -   | -   | -   | -         | -   | -   | -         | -   | -   | - |
| 1/4,S1/2        | -      | ○   | -   | ○             | -  | ○         | -     | -   | -   | -   | -         | -   | -   | -   | ○         | ○   | ○   | ○   | -         | -   | -   | -         | -   | -   | - |
| 1/2,S1          | -      | ○   | -   | ○             | ○  | -         | ○     | -   | -   | -   | ○         | -   | -   | -   | ○         | ○   | ○   | ○   | ○         | -   | -   | -         | ○   | -   | - |
| 1,S2            | -      | ○   | ○   | ○             | ○  | -         | -     | ○   | -   | -   | -         | ○   | -   | -   | ○         | ○   | ○   | ○   | -         | ○   | -   | -         | ○   | -   | - |
| 2,S3            | -      | ○   | ○   | -             | ○  | -         | -     | -   | ○   | -   | -         | -   | ○   | -   | ○         | ○   | ○   | ○   | -         | -   | ○   | -         | -   | -   | ○ |

**■ 試驗條件與方法 The testing method and condition.**

| 試驗項目<br>Test Items                   | 規格值<br>Performance Requirements          | 試驗方法<br>Test Methods and Standard.(JISC5201-1)  |
|--------------------------------------|--|---|
| 電阻值<br>Resistance                    | 規定的誤差值內<br>Within of specified tolerance | 測量點從端蓋 10mm<br>Measuring points are distance 10mm from the end cap(4.5)                     |
| 溫度係數<br>T.C.R.                       | 規定值內<br>Within of specified T.C.R.       | 室溫+100°C<br>Room temperature +100°C(4.8)  |
| 短時間過負荷<br>Short time overload        | ±(1%+0.05Ω)                              | 6.25 倍額定功率，5 秒<br>6.25 times the rated power for 5 seconds(4.13)                            |
| 負荷壽命<br>Load life                    | ±(1.5%+0.05Ω)                            | Rated voltage at 70°C for 1,000 hours<br>1.5hr ON / 0.5hr OFF Cycles(4.25.1)                |
| 耐濕負荷壽命<br>Load life in humidity      | ±(5%+0.1Ω)                               | 10% rate power load<br>40°C, 95% RH for 1,000 hours<br>1.5h ON / 0.5h OFF cycle(4.24)       |
| 耐濕性<br>Moisture resistance           | ±(1%+0.05Ω)                              | 40°C · 95% RH · 240 小時<br>40°C, 95% RH for 240 hours  |
| 溫度循環<br>Temperature cycle            | ±(1%+0.05Ω)                              | 5 cycles for -25°C (30min) : room temp. (30min)<br>~ +85°C (30min) room temp. (30min)(4.19) |
| 斷續過負荷<br>Intermittent overload       | ±(1%+0.05Ω)                              | Applicable more than100Ω : Rated voltage ×3<br>1s ON / 25s OFF , 1,000 cycles(4.13)         |
| 焊錫耐熱<br>Resistance to soldering heat | ±(1%+0.05Ω)                              | 260°C ± 5°C for 10 seconds (焊錫槽)<br>350°C ± 10°C for 3.5 seconds (手焊錫)(4.18)                |
| 絕緣電阻<br>Insulation resistance        | >1,000MΩ                                 | 500V 絕緣測試 1 分鐘<br>500V insulation test 1min.(4.6.1)   |

# POWER TYPE

**RPU** 金屬皮膜精密電阻器  
METAL FILM PRECISION RESISTOR (Standard Type)

**RPS** 小型金屬皮膜精密電阻器  
METAL FILM PRECISION RESISTOR (Small Type)



## 結構圖 Construction

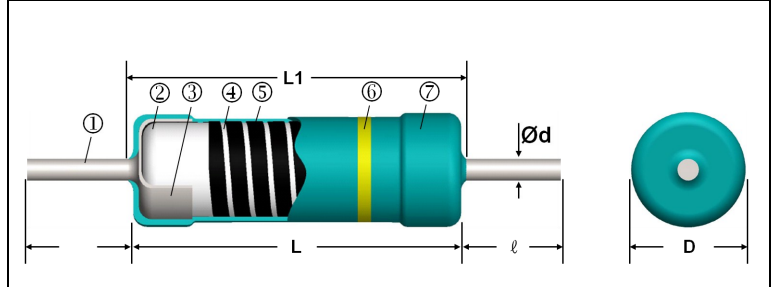

|   |     |                        |   |      |                       |
|---|-----|------------------------|---|------|-----------------------|
| 1 | 端子線 | Lead wire              | 5 | 導電皮膜 | Conductive film       |
| 2 | 瓷棒  | Ceramic base           | 6 | 標示   | Marking or color code |
| 3 | 鐵帽  | Cap                    |   |      |                       |
| 4 | 切割線 | Helical cutting groove | 7 | 絕緣塗料 | Insulation coat       |

塗裝顏色(Coating Color) :

≤ 1/6W Blue epoxy paint

≤ 1/6W 藍色環氧樹脂塗料

≥ 1/4W RPU/ gray; RPS/ pink

≥ 1/4W RPU / 灰色 ; RPS / 粉紅色

標示 (Marking) :

色碼 (Color Code) ( ≤ S1/2 )

文字 (Alphanumeric) (1/2~S3)

## 外型尺寸 Dimensions

| Rated Power (W) | Dimensions (mm) |         |         |           |      | Weight (g)<br>(1000pcs) |
|-----------------|-----------------|---------|---------|-----------|------|-------------------------|
|                 | L               | L1 Max. | D       | Ød        | l    |                         |
| 1/8, 1/6, S1/4  | 3.5±0.5         | 5       | 1.7±0.3 | 0.45±0.05 | 27±3 | 110                     |
| 1/4, S1/2       | 6.0±0.5         | 7       | 2.3±0.3 | 0.6±0.05  | 27±3 | 210                     |
| 1/2, S1         | 9±1             | 11      | 3.2±0.5 | 0.6±0.05  | 27±3 | 285                     |
| 1, S2           | 12±1            | 15      | 4.0±0.5 | 0.8±0.05  | 38±3 | 728                     |
| 2, S3           | 16±1            | 18      | 5.5±0.5 | 0.8±0.05  | 38±3 | 1380                    |

## 特性 Feature

◎高精密低溫度係數金屬膜電阻器.電阻值容許差± 0.01%

High precision and low T.C.R. of metal film resistor  
and resistance tolerance±0.01%.

◎長期穩定性佳

Excellent stability for long time service.

◎產品符合歐盟 RoHS 要求

Products is compliance the EU-RoHS request.

## 料號編碼 Type composition

例 Example

| RP         | U           | 14                  | F                | R100                 | A520               | NH                 |
|------------|-------------|---------------------|------------------|----------------------|--------------------|--------------------|
| 型名<br>Type | 品名<br>Size  | 額定功率<br>Rated Power | 誤差值<br>Tolerance | 電阻值(Ω)<br>Resistance | 二次加工<br>Forming    | 端子線<br>Lead Wire   |
|            | U: Standard | 18:1/8W             | F±1%             | 10R0=10              | See table<br>below | 熱鍍線<br>Heat plated |
|            | S: Small    | 14:1/4W             | D±0.5%           | 1000=100             |                    |                    |
|            |             | 12:1/2W             | B±0.1%           | 1001=1K              |                    |                    |
|            |             | 01:1W               |                  | 1002=10K             |                    |                    |
|            |             | 02:2W               |                  | 1003=100K            |                    |                    |

## 參考規格 Reference standards

● JIS C 5201-1

## 額定 Ratings

| Rated Power (W)  | 阻值範圍 Resistance Range (Ω) | 最高使用電壓 Max. Working Voltage | 最高過負荷電壓 Max. Overload Voltage | 耐電壓 Dielectric Withstanding Voltage | 溫度係數 T.C.R. | 包裝 Taping/Ammo, Forming/Bulk pack (pcs) |     |      |      |      |      |
|------------------|---------------------------|-----------------------------|-------------------------------|-------------------------------------|-------------|---|-----|------|------|------|------|
|                  | 0.01%、0.02%、0.05%、0.1%、1% |                             |                               |                                     |             | A26                                     | A52 | A64  | FT   | YT   | L    |
| 1/8, 1/6<br>S1/4 | 10Ω~100K                  | 200V                        | 250V                          | 300V                                | ± 100ppm/°C | 5000                                    | —   | —    | —    | —    | —    |
| 1/4, S1/2        |                           | 250V                        |                               |                                     |             | 500V                                    | —   | 2500 | —    | 2000 | —    |
| 1/2, S1          |                           |                             | —                             | 2000                                |             |   | —   | 1000 | 2000 | 2500 |      |
| 1, S2            |                           |                             | 350V                          | 700V                                |             |   | —   | 1000 | 1000 | 1000 | 1000 |
| 2, S3            |                           | —                           |                               |                                     |             | 500                                     | 500 | —    | 1000 | 1000 |      |



■ 額定溫度下降曲線圖 Derating curve

例 Example

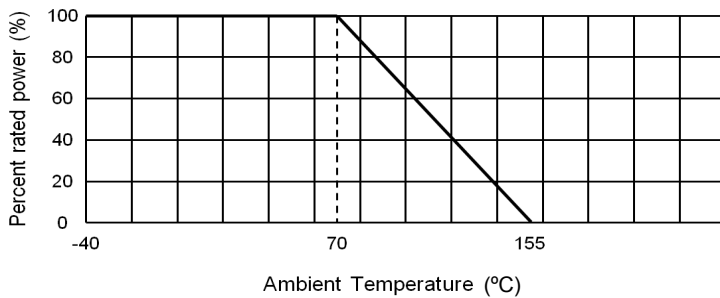

■ 二次加工對應表 Taping & Forming Matrix

| Rated Power (W) | Taping |     |     | Radial Taping |    | L Forming |       |     |     |     | C Forming |     |     |     | F Forming |     |     |     | M Forming |     |     | D Forming |     |     |   |
|-----------------|--------|-----|-----|---------------|----|-----------|-------|-----|-----|-----|-----------|-----|-----|-----|-----------|-----|-----|-----|-----------|-----|-----|-----------|-----|-----|---|
|                 | A26    | A52 | A64 | FT            | YT | L10       | L12.5 | L15 | L20 | L30 | C12.5     | C15 | C20 | C30 | FA5       | FB5 | FC5 | FD5 | M12.5     | M15 | M20 | D12.5     | D15 | D20 |   |
| 1/8,1/6         | ○      | -   | -   | -             | -  | -         | -     | -   | -   | -   | -         | -   | -   | -   | -         | -   | -   | -   | -         | -   | -   | -         | -   | -   | - |
| 1/4,S1/2        | -      | ○   | -   | ○             | -  | ○         | -     | -   | -   | -   | -         | -   | -   | -   | ○         | ○   | ○   | ○   | -         | -   | -   | -         | -   | -   | - |
| 1/2,S1          | -      | ○   | -   | ○             | ○  | -         | ○     | -   | -   | -   | ○         | -   | -   | -   | ○         | ○   | ○   | ○   | ○         | -   | -   | ○         | -   | -   | - |
| 1,S2            | -      | ○   | ○   | ○             | ○  | -         | -     | ○   | -   | -   | -         | ○   | -   | -   | ○         | ○   | ○   | ○   | -         | ○   | -   | -         | ○   | -   | - |
| 2,S3            | -      | ○   | ○   | -             | ○  | -         | -     | -   | ○   | -   | -         | -   | ○   | -   | ○         | ○   | ○   | ○   | -         | -   | ○   | -         | -   | -   | ○ |

■ 試驗條件與方法 The testing method and condition.

| 試驗項目<br>Test Items                   | 規格值<br>Performance Requirements          | 試驗方法<br>Test Methods and Standard.(JISC5201-1)  |
|--------------------------------------|--|---|
| 電阻值<br>Resistance                    | 規定的誤差值內<br>Within of specified tolerance | 測量點從端蓋 10mm<br>Measuring points are distance 10mm from the end cap(4.5)                     |
| 溫度係數<br>T.C.R.                       | 規定值內<br>Within of specified T.C.R.       | 室溫+100°C<br>Room temperature +100°C(4.8)  |
| 短時間過負荷<br>Short time overload        | ±(1%+0.05Ω)                              | 6.25 倍額定功率，5 秒<br>6.25 times the rated power for 5 seconds(4.13)                            |
| 負荷壽命<br>Load life                    | ±(1.5%+0.05Ω)                            | Rated voltage at 70°C for 1,000 hours<br>1.5hr ON / 0.5hr OFF Cycles(4.25.1)                |
| 耐濕負荷壽命<br>Load life in humidity      | ±(5%+0.1Ω)                               | 10% rate power load<br>40°C, 95% RH for 1,000 hours<br>1.5h ON / 0.5h OFF cycle(4.24)       |
| 耐濕性<br>Moisture resistance           | ±(1%+0.05Ω)                              | 40°C · 95% RH · 240 小時<br>40°C, 95% RH for 240 hours  |
| 溫度循環<br>Temperature cycle            | ±(1%+0.05Ω)                              | 5 cycles for -25°C (30min) : room temp. (30min)<br>~ +85°C (30min) room temp. (30min)(4.19) |
| 斷續過負荷<br>Intermittent overload       | ±(1%+0.05Ω)                              | Applicable more than100Ω : Rated voltage ×3<br>1s ON / 25s OFF , 10,000 cycles(4.13)        |
| 焊錫耐熱<br>Resistance to soldering heat | ±(1%+0.05Ω)                              | 260°C ± 5°C for 10 seconds (焊錫槽)<br>350°C ± 10°C for 3.5 seconds (手焊錫)(4.18)                |
| 絕緣電阻<br>Insulation resistance        | >1,000MΩ                                 | 500V 絕緣測試 1 分鐘<br>500V insulation test 1min.(4.6.1)   |

# DISCHARGE PATH RESISTOR

**RMU** 金屬釉電阻器  
METAL GLAZE RESISTOR (Standard Type)

**RMS** 小型金屬釉電阻器  
METAL GLAZE RESISTOR (Small Type)

**RMH** 大型金屬釉電阻器  
METAL GLAZE RESISTOR (Large-scale Type)



塗裝顏色(Coating Color) :

標準品 Standard Type (1/6W, 1/4W Dark blue ,other pink)

小型品 Small Type (≥ 1/2W Pink)

大型品 Large-scale Type (Pink)

標示 (Marking) :

色碼 (Color Code) (≤ S1/2W)

文字 (Alphanumeric) (1/2W~S3W、H1W)

## 特性 Feature

◎使用不燃性塗料，具不燃與絕緣之安全特性(UL94 V-0)

Flameproof and insulating coating designed to assure safe usage by special non-flammable silicon-base.

(Equivalent to UL94 V-0)

◎產品符合歐盟 RoHS 要求

Products is compliance the EU-RoHS request.

## 產品認證 Approvals awarded

● UL 1676 & c-UL (CSA C22.2 No.1-98)File No.E220321

1/2,1,2 Watt,680K to 10M 125V : 1/2,1,2 Watt,960K to 12M 250V

● EN 60065 (VDE 0860) : 2011-10 Clause 14.1a、14.1b

Ausweis-Nr : 40030403 (1/4,1/2,1 Watt)100K to 100M

Ausweis-Nr : 40030404 (1/2,1,2 Watt)100K to 100M

● SEMKO&CB : 1/4,1/2,1,2 Watt,100K to 100M. Reference No.913033

1/4,1/2,1,2 Watt,100K to 100M

## 額定 Ratings

| Rated Power (W) | 阻值範圍 Resistance Range (Ω) |            |            | 最高使用電壓 Max. Working Voltage | 耐電壓 Dielectric Withstanding Voltage | 溫度係數 T.C.R.   | 包裝 Taping/Ammo,Forming/Bulk pack (pcs) |      |     |      |      |      |      |      |      |      |
|-----------------|---------------------------|------------|------------|-----------------------------|-------------------------------------|---|--|------|-----|------|------|------|------|------|------|------|
|                 | F±1% (E96)                | G±2% (E24) | J±5% (E24) |                             |                                     |   | A26                                    | A52  | A64 | FT   | YT   | L    | C    | M    | D    |      |
| 1/6,S1/4        | 10Ω ~ < 100M              |            |            | 300V                        | 300V                                | F±1%:<br>±100ppm/°C<br>G±2%:<br>±200ppm/°C<br>J±5%:<br>±200ppm/°C | 5000                                   | -    | -   | -    | -    | -    | -    | -    |      |      |
| 1/4,S1/2        |                           |            |            | 1600V                       |                                     |   | -                                      | 2500 | -   | 2000 | -    | 2500 | 2500 | 2500 | 2500 |      |
| 1/2,S1          |                           |            |            | 3500V                       |                                     |   | -                                      | 2000 | -   | 2000 | 2000 | 2500 | 2500 | 2500 | 2500 |      |
| 1,S2            |                           |            |            | 7000V                       |                                     |   | -                                      | 1000 | -   | 1000 | 1000 | 1000 | 1000 | 1000 | 1000 | 1000 |
| 2,S3,H1         |                           |            |            | 10000V                      |                                     |   | -                                      | 500  | 500 | -    | 1000 | 1000 | 1000 | 1000 | 1000 | 1000 |

## 結構圖 Construction

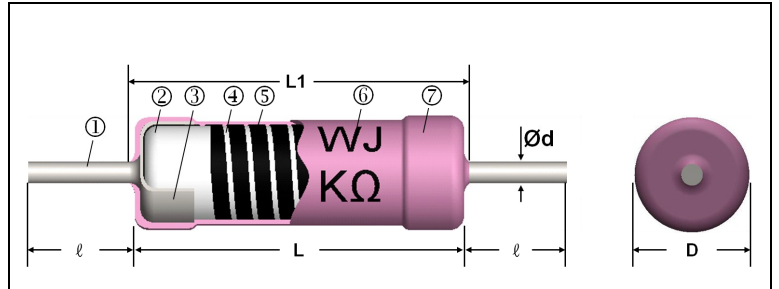

|   |     |                        |   |       |                       |
|---|-----|------------------------|---|-------|-----------------------|
| 1 | 端子線 | Lead wire              | 5 | 金屬釉皮膜 | Metal glaze film      |
| 2 | 瓷棒  | Ceramic base           | 6 | 標示    | Marking or color code |
| 3 | 鐵帽  | Cap                    |   |       |                       |
| 4 | 切割線 | Helical cutting groove | 7 | 絕緣塗料  | Insulation coat       |

## 外型尺寸 Dimensions

| Rated Power (W) | Dimensions (mm) |         |         |              |      | Weight (g) (1000pcs) |
|-----------------|-----------------|---------|---------|--------------|------|----------------------|
|                 | L               | L1 Max. | D       | Ød           | ℓ    |                      |
| 1/6,S1/4        | 3.3±0.3         | 4       | 1.8±0.2 | 0.45±0.05    | 28±2 | 120                  |
| 1/4,S1/2        | 6.0±0.5         | 7       | 2.4±0.3 | 0.6±0.05     | 28±2 | 218                  |
| 1/2,S1          | 9±0.5           | 11      | 3.3±0.5 | 0.6/0.8±0.05 | 28±3 | 320                  |
| 1,S2            | 12±1            | 15      | 4.5±0.5 | 0.8±0.05     | 38±3 | 780                  |
| 2,S3,H1         | 16±1            | 18      | 5.5±0.5 |              |      | 1450                 |

## 料號編碼 Type composition

例 Example

| R       | U              | 14               | J             | 1005              | A520            | NL                 |
|---------|----------------|------------------|---------------|-------------------|-----------------|--------------------|
| 型名 Type | 品名 Size        | 額定功率 Rated Power | 誤差值 Tolerance | 電阻值(Ω) Resistance | 二次加工 Forming    | 端子線 Lead Wire      |
|         | U: Standard    | 16:1/6W          | F±1%          | 10R0=10           | See table below | 電鍍線 Electro plated |
|         | S: Small       | 14:1/4W          | G±2%          | 1000=100          |                 |                    |
|         | H: Large-scale | 12:1/2W          | J±5%          | 1001=1K           |                 |                    |
|         |                | 01:1W            |               | 1002=10K          |                 |                    |
|         |                | 02:2W            |               | 1003=100K         |                 |                    |
|         |                | 03:3W            |               | 1004=1M           |                 |                    |
|         |                |                  |               | 1005=10M          |                 |                    |

### ■ 額定溫度下降曲線圖 Derating curve

例 Example

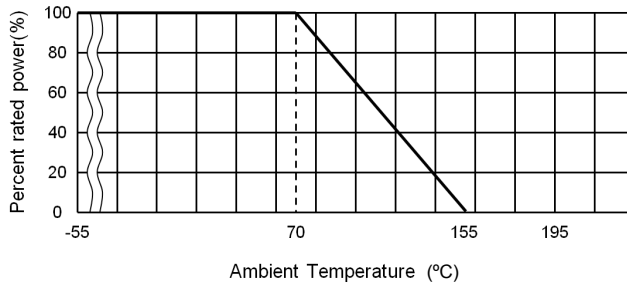

### ■ 二次加工對應表 Taping & Forming Matrix

| Rated Power (W) | Taping |     |     | Radial Taping |    | L Forming |       |     |     | C Forming |     |     | F Forming |     |     |     | M Forming |     |     | D Forming |     |     |   |
|-----------------|--------|-----|-----|---------------|----|-----------|-------|-----|-----|-----------|-----|-----|-----------|-----|-----|-----|-----------|-----|-----|-----------|-----|-----|---|
|                 | A26    | A52 | A64 | FT            | YT | L10       | L12.5 | L15 | L20 | C12.5     | C15 | C20 | FA5       | FB5 | FC5 | FD5 | M12.5     | M15 | M20 | D12.5     | D15 | D20 |   |
| 1/6,S1/4        | ○      | ○   | -   | -             | -  | -         | -     | -   | -   | -         | -   | -   | -         | -   | -   | -   | -         | -   | -   | -         | -   | -   | - |
| 1/4,S1/2        | -      | ○   | -   | ○             | -  | ○         | -     | -   | -   | -         | -   | -   | -         | -   | -   | -   | -         | -   | -   | -         | -   | -   | - |
| 1/2,S1          | -      | ○   | -   | ○             | ○  | -         | ○     | -   | -   | ○         | -   | -   | ○         | ○   | ○   | ○   | ○         | -   | -   | -         | ○   | -   | - |
| 1,S2            | -      | ○   | -   | ○             | ○  | -         | -     | ○   | -   | -         | ○   | -   | ○         | ○   | ○   | ○   | -         | ○   | -   | -         | -   | ○   | - |
| 2,S3,H1         | -      | ○   | ○   | -             | ○  | -         | -     | -   | ○   | -         | -   | ○   | ○         | ○   | ○   | ○   | -         | -   | ○   | -         | -   | -   | ○ |

### ■ 試驗條件與方法 The testing method and condition.

| 試驗項目<br>Test Items                   | 規格值<br>Performance Requirements           | 試驗方法<br>Test Methods and Standard.(JISC5201-1)   |
|--------------------------------------|---|--|
| 電阻值<br>Resistance                    | 規定的誤差值內<br>Within of specified tolerance  | 測量點從端蓋 10mm<br>Measuring points are distance 10mm from the end cap(4.5)  |
| 溫度係數<br>T.C.R.                       | 規定值內<br>Within of specified T.C.R.        | 室溫+100°C<br>Room temperature +100°C(4.8)   |
| 短時間過負荷<br>Short time overload        | ±(1%+0.05Ω)                               | 6.25 倍額定功率，5 秒<br>6.25 times the rated power for 5 seconds(4.13)   |
| 負荷壽命<br>Load life                    | ±(1.5%+0.1Ω)                              | Rated voltage at 70°C for 1,000 hours<br>1.5hr ON / 0.5hr OFF Cycles(4.25.1)   |
| 耐濕負荷壽命<br>Load life in humidity      | ±(5%+0.1Ω)                                | 10% rate power load<br>40°C, 95% RH for 1,000 hours<br>1.5h ON / 0.5h OFF cycle(4.24)  |
| 耐濕性<br>Moisture resistance           | ±(1%+0.05Ω)                               | 40°C, 95% RH, 240 小時<br>40°C, 95% RH for 240 hours   |
| 溫度循環<br>Temperature cycle            | ±(1%+0.05Ω)                               | 5 cycles for -25°C (30min) : room temp. (30min)<br>~ +85°C (30min) room temp. (30min)(4.19)  |
| 斷續過負荷<br>Intermittent overload       | ±(5%+0.1Ω)                                | Applicable more than 100Ω ; Rated voltage ×3<br>1s ON / 25s OFF , 10,000 cycles(4.13)  |
| 焊錫耐熱<br>Resistance to soldering heat | ±(1%+0.05Ω)                               | 260°C ± 5°C for 10 seconds (焊錫槽)<br>350°C ± 10°C for 3.5 seconds (手焊錫)(4.18)   |
| 絕緣電阻<br>Insulation resistance        | >1,000MΩ                                  | 500V 絕緣測試 1 分鐘<br>500V insulation test 1min.(4.6.1)  |
| 不燃性<br>Flameproof                    | 無燃燒現象<br>No evidence of flaming or arcing | AC voltage of 2,4,8,16,32 times the power rating for 1min. (V ≤ 4 times max. working voltage)  |
| 脈衝測試<br>Pulse withstanding voltage   | ±20%<br>                                  | The following discharge cycle is repeated in the circuit of the left fig.<br>2.5 sec. ON 2.5 sec. OFF 50 cycles.<br>With following DC pulse test voltage.<br>Pulse voltage: 1/6W,S1/4W : (3KV).<br>≥ 1/4W < 100K:(3KV)//100 K~620K:(5KV)<br>> 620 K:(10KV)<br>Capacitor : UL-0.01 μF<br>Non-UL 0.001μF |

# HIGH VOLTAGE PATH RESISTOR

**RVU** 耐突波電阻器  
SURGE RESISTOR (Standard Type)

**RVS** 小型耐突波電阻器  
SURGE RESISTOR (Small Type)

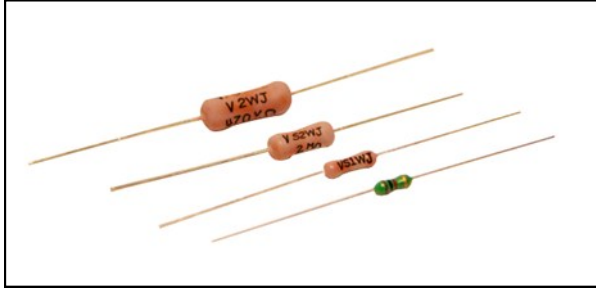

塗裝顏色(Coating Color) :

標 示 (Marking)

文 字 (Alphanumeric)

## 結構圖 Construction

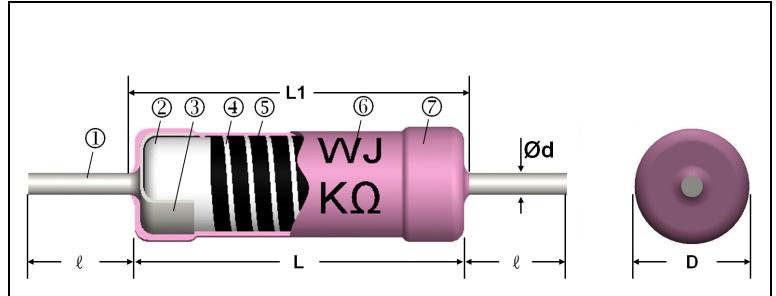

|   |     |                        |   |       |                  |
|---|-----|------------------------|---|-------|------------------|
| 1 | 端子線 | Lead wire              | 5 | 金屬釉皮膜 | Metal glaze film |
| 2 | 瓷 棒 | Ceramic base           | 6 | 標 示   | Marking          |
| 3 | 鐵 帽 | Cap                    |   |       |                  |
| 4 | 切割線 | Helical cutting groove | 7 | 絕緣塗料  | Insulation coat  |

## 特性 Feature

◎阻值範圍：680K~3G

Resistance value range is 680K~3G.

◎長期穩定性佳

Stable and long service life.

◎可承受 10KV 突波的衝擊

Acceptable pulse of 10KV discharge.

◎溫度係數小

Small temp. coeff. of resistance.

◎產品符合歐盟 RoHS 要求

Products is compliance the EU-RoHS request.

## 外型尺寸 Dimensions

| Rated Power (W) | Dimensions (mm) |         |         |          |      | Weight (g)<br>(1000pcs) |
|-----------------|-----------------|---------|---------|----------|------|-------------------------|
|                 | L               | L1 Max. | D       | Ød       | l    |                         |
| 1/2,S1          | 9±0.5           | 11      | 3.3±0.5 | 0.6±0.05 | 28±3 | 285                     |
| 1,S2            | 12±1            | 15      | 4.5±0.5 | 0.8±0.05 | 38±3 | 728                     |
| 2,S3            | 16±1            | 18      | 5.5±0.5 | 0.8±0.05 | 38±3 | 1380                    |

## 料號編碼 Type composition

例 Example

| RV         | U                       | 12                                 | J                | 1004                 | A520               | NH                              |
|------------|-------------------------|------------------------------------|------------------|----------------------|--------------------|---------------------------------|
| 型名<br>Type | 品名<br>Size              | 額定功率<br>Rated Power                | 誤差值<br>Tolerance | 電阻值(Ω)<br>Resistance | 二次加工<br>Forming    | 端子線<br>Lead Wire                |
|            | U: Standard<br>S: Small | 12:1/2W<br>01:1W<br>02:2W<br>03:3W | J±5%             | 1003=100K<br>1004=1M | See table<br>below | 熱鍍線<br>Heat plated<br>SS :Small |

## 參考規格 Reference standards

● JIS C 5201-1

## 二次加工對應表 Taping & Forming Matrix

| Rated Power (W) | Taping |     |     | Radial Taping |    | L Forming |       |     |     | C Forming |     |     | F Forming |     |     |     | M Forming |     |     | D Forming |     |     |
|-----------------|--------|-----|-----|---------------|----|-----------|-------|-----|-----|-----------|-----|-----|-----------|-----|-----|-----|-----------|-----|-----|-----------|-----|-----|
|                 | A26    | A52 | A64 | FT            | YT | L10       | L12.5 | L15 | L20 | C12.5     | C15 | C20 | FA5       | FB5 | FC5 | FD5 | M12.5     | M15 | M20 | D12.5     | D15 | D20 |
| 1/2,S1          | -      | ○   | -   | ○             | ○  | -         | ○     | -   | -   | ○         | -   | -   | ○         | ○   | ○   | ○   | ○         | -   | -   | ○         | -   | -   |
| 1,S2            | -      | ○   | ○   | ○             | ○  | -         | -     | ○   | -   | -         | ○   | -   | ○         | ○   | ○   | ○   | -         | ○   | -   | -         | ○   | -   |
| 2,S3            | -      | ○   | ○   | -             | ○  | -         | -     | -   | ○   | -         | -   | ○   | ○         | ○   | ○   | ○   | -         | -   | ○   | -         | -   | ○   |

## 額定 Ratings

| Rated Power (W) | 阻值範圍 Resistance Range (Ω) |  | 最高使用電壓 Max. Working Voltage | 耐電壓 Dielectric Withstanding Voltage | 溫度係數 T.C.R. | 包裝 Taping/Ammo,Forming/Bulk pack (pcs) |      |      |      |      |      |      |      |      |  |
|-----------------|---------------------------|--|-----------------------------|-------------------------------------|-------------|--|------|------|------|------|------|------|------|------|--|
|                 | J±5% (E24)                |  |                             |                                     |             | A26                                    | A52  | A64  | FT   | YT   | L    | C    | M    | D    |  |
| 1/2,S1          | 680K~10M                  |  | 3500V                       | 700V                                | ±200ppm/°C  | -                                      | 2000 | -    | 2000 | 2000 | 2500 | 2500 | 2500 | 2500 |  |
| 1,S2            |                           |  | -                           |                                     |             | 1000                                   | 1000 | 1000 | 1000 | 1000 | 1000 | 1000 |      |      |  |
| 2,S3            |                           |  | -                           |                                     |             | 500                                    | 500  | 1000 | 1000 | 1000 | 1000 | 1000 | 1000 |      |  |

■ 額定溫度下降曲線圖 Derating curve

例 Example

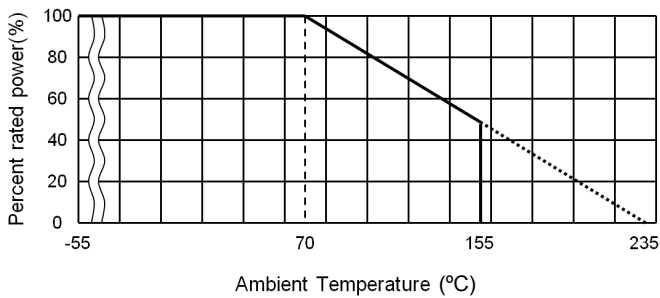

■ 試驗條件與方法 The testing method and condition.

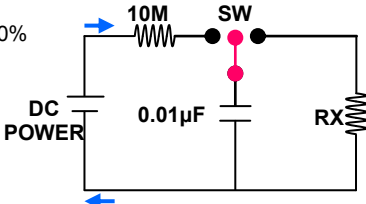
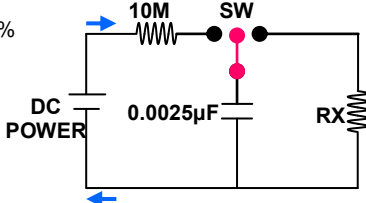
| 試驗項目<br>Test Items                            | 規格值<br>Performance Requirements          | 試驗方法<br>Test Methods and Standard.(JISC5201-1)   |
|---|--|--|
| 電阻值<br>Resistance                             | 規定的誤差值內<br>Within of specified tolerance | 測量點從端蓋 10mm<br>Measuring points are distance 10mm from the end cap(4.5)  |
| 溫度係數<br>T.C.R.                                | 規定值內<br>Within of specified T.C.R.       | 室溫+100°C<br>Room temperature +100°C(4.8)   |
| 短時間過負荷<br>Short time overload                 | ±(1%+0.05Ω)                              | 6.25 倍額定功率，5 秒<br>6.25 times the rated power for 5 seconds(4.13)   |
| 負荷壽命<br>Load life                             | ±(1.5%+0.1Ω)                             | Rated voltage at 70°C for 1,000 hours<br>1.5hr ON / 0.5hr OFF Cycles(4.25.1)   |
| 耐濕負荷壽命<br>Load life in humidity               | ±(5%+0.1Ω)                               | 10% rate power load<br>40°C, 95% RH for 1,000 hours<br>1.5h ON / 0.5h OFF cycle(4.24)  |
| 耐濕性<br>Moisture resistance                    | ±(1%+0.05Ω)                              | 40°C，95% RH，240 小時<br>40°C, 95% RH for 240 hours   |
| 溫度循環<br>Temperature cycle                     | ±(1%+0.05Ω)                              | 5 cycles for -25°C (30min) : room temp. (30min)<br>~ +85°C (30min) room temp. (30min)(4.19)  |
| 焊錫耐熱<br>Resistance to soldering heat          | ±(1%+0.05Ω)                              | 260°C ±5°C for 10 seconds (焊錫槽)<br>350°C ±10°C for 3.5 seconds (手焊錫)   |
| 絕緣電阻<br>Insulation resistance                 | ≥ 50GΩ                                   | 500V 絕緣測試 1 分鐘<br>500V insulation test 1min.(4.6.1)  |
| UL 脈衝測試<br>UL Pulse withstanding voltage      | ±20%                                     |  <p>The following discharge cycle is repeated in the circuit of the left fig.<br/>2.5 sec. ON 2.5 sec. OFF 50 cycles.<br/>Test voltage (DC surge) 10KV(Max)</p>                                 |
| 台灣雙羽脈衝試驗<br>Futaba Pulse withstanding voltage | ±3%                                      |  <p>The following discharge cycle is repeated in the circuit of the left fig.<br/>1 sec. ON 1 sec. OFF 50 cycles.<br/>Test voltage (DC surge) is shown below:<br/>Pulse voltage : 14KV(Max)</p> |

耐突波測試 Surge Test

| High Energy Test 高能量測試           |               | Low Energy Test 低能量測試            |               |
|----------------------------------|---------------|----------------------------------|---------------|
| ITEM 項目                          | SPEC. 規格      | ITEM 項目                          | SPEC. 規格      |
| Capacitance 電容值 (µF)             | 0.12µF        | Capacitance 電容值 (µF)             | 0.03µF        |
| Voltage 電壓 (KV)                  | 10KV          | Voltage 電壓 (KV)                  | 10KV          |
| Charging/Discharge Time 充/放電時間   | 10sec / 2sec  | Charging/Discharge Time 充/放電時間   | 10sec / 2sec  |
| Cycle 週期                         | 12sec         | Cycle 週期                         | 12sec         |
| Charging/Discharge Cycles 充/放電次數 | 1,000 Cycles  | Charging/Discharge Cycles 充/放電次數 | 10,000 Cycles |
| Criteria 判定標準                    | + 100% ~ -20% | Criteria 判定標準                    | + 100% ~ -10% |

# HIGH VOLTAGE PATH RESISTOR

**RRU** 高阻值金屬釉電阻器  
HIGH RESISTANCE RESISTOR (Standard Type)

**RRS** 高阻值小型金屬釉電阻器  
HIGH RESISTANCE RESISTOR (Small Type)

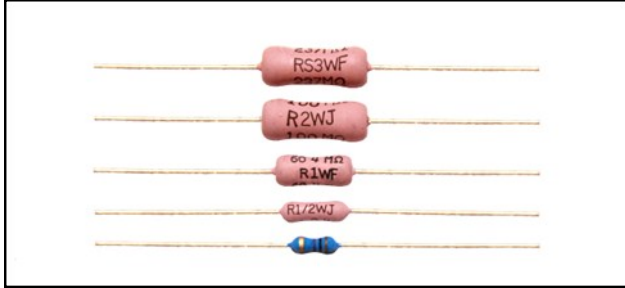

## 結構圖 Construction



|   |     |                        |   |       |                       |
|---|-----|------------------------|---|-------|-----------------------|
| 1 | 端子線 | Lead wire              | 5 | 金屬釉皮膜 | Metal glaze film      |
| 2 | 瓷棒  | Ceramic base           | 6 | 標示    | Marking or color code |
| 3 | 鐵帽  | Cap                    |   |       |                       |
| 4 | 切割線 | Helical cutting groove | 7 | 絕緣塗料  | Insulation coat       |

塗裝顏色(Coating Color):  
RRU1/6W、RRU1/4W 深藍色 Dark blue 粉紅色 other pink

標示 (Marking):

色碼 (Color Code) ≤ S1/2W

文字 (Alphanumeric) 1/2W~S3W

## 外型尺寸 Dimensions

| Rated Power (W) | Dimensions (mm) |         |         |           |      | Weight (g)<br>(1000pcs) |
|-----------------|-----------------|---------|---------|-----------|------|-------------------------|
|                 | L               | L1 Max. | D       | Ød        | ℓ    |                         |
| 1/6,S1/4        | 3.3±0.3         | 4       | 1.8±0.2 | 0.45±0.05 | 28±2 | 120                     |
| 1/4,S1/2        | 6.0±0.3         | 7       | 2.4±0.1 | 0.6±0.05  | 28±2 | 218                     |
| 1/2,S1          | 9±0.5           | 11      | 3.3±0.5 |           | 28±3 | 320                     |
| 1,S2            | 12±1            | 15      | 4.5±0.5 | 0.8±0.05  | 38±3 | 780                     |
| 2,S3            | 16±1            | 18      | 5.5±0.5 |           |      | 1450                    |
| 5W,S7W          | 24±1            | 26      | 8±10.5  |           |      | 3800                    |

## 特性 Feature

- ◎阻值範圍 101MΩ~3GΩ  
Resistance value range is 101MΩ~3GΩ.
- ◎溫度係數可低至 50ppm 一般為 200ppm  
Low T.C.R.to 50ppm. Normal is 200ppm.
- ◎長期穩定性與長效使用壽命  
Long load life and long term stability.
- ◎產品符合歐盟 RoHS 要求  
Products is compliance the EU-RoHS request.

## 料號編碼 Type composition

例 Example

| RR         | U           | 14                  | J                | 10R0                 | A520            | NH               |
|------------|-------------|---------------------|------------------|----------------------|-----------------|------------------|
| 型名<br>Type | 品名<br>Size  | 額定功率<br>Rated Power | 誤差值<br>Tolerance | 電阻值(Ω)<br>Resistance | 二次加工<br>Forming | 端子線<br>Lead Wire |
|            | U: Standard | 16:1/6W             | F±1%             | 1006=100M            | See table       | 熱鍍線              |
|            | S: Small    | 14:1/4W             | G±2%             | 1007=1G              | below           | Heat plated      |
|            |             | 12:1/2W             | J±5%             |                      |                 |                  |
|            |             | 01:1W               |                  |                      |                 |                  |
|            |             | 02:2W               |                  |                      |                 |                  |
|            |             | 03:3W               |                  |                      |                 |                  |
|            |             | 05:5W               |                  |                      |                 |                  |
|            |             | 07:7W               |                  |                      |                 |                  |

## 參考規格 Reference standards

- JIS C 5201-1

## 額定 Ratings

| Rated Power (W) | 阻值範圍 Resistance Range (Ω)<br>J±5% (E24) | 最高使用電壓<br>Max. Working Voltage | 耐電壓 Dielectric<br>Withstanding Voltage | 溫度係數<br>T.C.R.                             | 包裝 Taping/Ammo,Forming/Bulk pack (pcs) |      |      |      |      |      |      |      |      |   |
|-----------------|---|--------------------------------|--|--|--|------|------|------|------|------|------|------|------|---|
|                 |   |                                |  |  | A26                                    | A52  | A64  | FT   | YT   | L    | C    | M    | D    |   |
| 1/6,S1/4        | ≥ 100M~3G                               | 500V                           | 700V                                   | ±200ppm/°C<br>(±50ppm/°C is contact salse) | 5000                                   | -    | -    | -    | -    | -    | -    | -    | -    | - |
| 1/4,S1/2        |   | 1600V                          |  |  | -                                      | 2500 | -    | 2000 | -    | 2500 | 2500 | 2500 | 2500 |   |
| 1/2,S1          |   | 3500V                          |  |  | -                                      | 2000 | -    | 2000 | 2000 | 1000 | 2500 | 2500 | 2500 |   |
| 1,S2            |   | 7000V                          |  |  | -                                      | 1000 | 1000 | 1000 | 1000 | 1000 | 1000 | 1000 | 1000 |   |
| 2,S3            |   | 10000V                         |  |  | -                                      | 500  | 500  | -    | 1000 | 1000 | 1000 | 1000 | 1000 |   |
| 5W,S7W          |   | 15000V                         |  |  | -                                      | -    | -    | -    | -    | 500  | 500  | 500  | 500  |   |

■ 額定溫度下降曲線圖 Derating curve

例 Example



■ 試驗條件與方法 The testing method and condition.

| 試驗項目<br>Test Items                       | 規格值<br>Performance Requirements   | 試驗方法<br>Test Methods and Standard.(JISC5201-1)  |
|--|---|---|
| 電阻值<br>Resistance                        | 規定的誤差值內<br>Within of specified tolerance  | 測量點從端蓋 10mm<br>Measuring points are distance 10mm from the end cap(4.5)   |
| 溫度係數<br>T.C.R.                           | 規定值內<br>Within of specified T.C.R.  | 室溫+100°C<br>Room temperature +100°C(4.8)  |
| 短時間過負荷<br>Short time overload            | ±(1%+0.05Ω)   | 6.25 倍額定功率，5 秒<br>6.25 times the rated power for 5 seconds(4.13)  |
| 負荷壽命<br>Load life                        | ±(1.5%+0.1Ω)  | Rated voltage at 70°C for 1,000 hours<br>1.5hr ON / 0.5hr OFF Cycles(4.25.1)  |
| 耐濕負荷壽命<br>Load life in humidity          | ±(5%+0.1Ω)  | 10% rate power load<br>40°C, 95% RH for 1,000 hours<br>1.5h ON / 0.5h OFF cycle(4.24)   |
| 耐濕性<br>Moisture resistance               | ±(1%+0.05Ω)   | 40°C, 95% RH, 240 小時<br>40°C, 95% RH for 240 hours  |
| 溫度循環<br>Temperature cycle                | ±(1.5%+0.05Ω)   | 5 cycles for -25°C (30min) : room temp. (30min)<br>~ +85°C (30min) room temp. (30min)(4.19)   |
| 焊錫耐熱<br>Resistance to soldering heat     | ±(1%+0.05Ω)   | 260°C ±5°C for 10 seconds (焊錫槽)<br>350°C ±10°C for 3.5 seconds (手焊錫)  |
| 絕緣電阻<br>Insulation resistance            | □50GΩ   | 500V 絕緣測試 1 分鐘<br>500V insulation test 1min.(4.6.1)   |
| UL 脈衝測試<br>UL Pulse withstanding voltage | ±20%<br> | The following discharge cycle is repeated in the circuit of the left fig.<br>2.5 sec. ON 2.5 sec. OFF 50 cycles.<br>Pulse test voltage (DC surge) 10KV. |

# FUSING RESISTOR

**RFU** 保險絲電阻器  
FUSIBLE RESISTOR (Standard Type)

**RFS** 小型保險絲電阻器  
FUSIBLE RESISTOR (Small Type)



塗料顏色 (Coating Color) :

標準品 (Standard Type) 灰 Gray

小型品 (Small Type) 粉紅 Pink

標示 (Marking) :

色環 (Color Code) 1/6W、1/4W、1/3W、S1/2W

文字 (Alphanumeric) 1/2W~S3W

## 特性 Feature

◎使用不燃性塗料,具不燃與絕緣之安全特性(UL94 V-0)

Flameproof and insulating coating designed to assure safe usage by special non-flammable silicon-base.

(Equivalent to UL94 V-0)

◎正常情況下具電阻功能

Function as a resistor in normal operation.

◎異常過負荷時可快速熔斷

Quick fusing protects circuit from excessive overload.

◎產品符合歐盟 RoHS 要求

Products is compliance the EU-RoHS request.

## 參考規格 Reference standards

● JIS C 5201-1

## 二次加工對應表 Taping & Forming Matrix

| Rated Power (W) | Taping |     |     | Radial Taping |    | L Forming |       |     |     |     | C Forming |     |     |     | F Forming |     |     |     | M Forming |     |     | D Forming |     |     |   |
|-----------------|--------|-----|-----|---------------|----|-----------|-------|-----|-----|-----|-----------|-----|-----|-----|-----------|-----|-----|-----|-----------|-----|-----|-----------|-----|-----|---|
|                 | A52    | A64 | A73 | FT            | YT | L10       | L12.5 | L15 | L20 | L30 | C12.5     | C15 | C20 | C30 | FA5       | FB5 | FC5 | FD5 | M12.5     | M15 | M20 | D12.5     | D15 | D20 |   |
| 1/6,S1/4        | ○      | -   | -   | -             | -  | -         | -     | -   | -   | -   | -         | -   | -   | -   | -         | -   | -   | -   | -         | -   | -   | -         | -   | -   | - |
| 1/4,S1/2,1/3    | ○      | -   | -   | ○             | -  | ○         | -     | -   | -   | -   | -         | -   | -   | -   | -         | -   | -   | -   | -         | -   | -   | -         | -   | -   | - |
| 1/2,S1,P2       | ○      | -   | -   | ○             | ○  | -         | ○     | -   | -   | -   | ○         | -   | -   | -   | ○         | ○   | ○   | ○   | ○         | -   | -   | -         | ○   | -   | - |
| 1,S2            | ○      | ○   | -   | ○             | ○  | -         | -     | ○   | -   | -   | -         | ○   | -   | -   | ○         | ○   | ○   | ○   | -         | ○   | -   | -         | -   | ○   | - |
| 2,S3            | -      | ○   | -   | -             | ○  | -         | -     | -   | ○   | -   | -         | ○   | -   | -   | ○         | ○   | ○   | ○   | -         | -   | ○   | -         | -   | -   | ○ |

## 額定 Ratings

| Rated Power (W) | 阻值範圍 Resistance Range (Ω) | 最高使用電壓 Max. Working Voltage | 最高過負荷電壓 Max. Overload Voltage | 耐電壓 Dielectric Withstanding Voltage | 溫度係數 T.C.R. | 包裝 Taping/Ammo,Forming/Bulk pack (pcs) |     |      |      |      |      |
|-----------------|---------------------------|-----------------------------|-------------------------------|-------------------------------------|-------------|--|-----|------|------|------|------|
|                 | J±5% (E24)                |                             |                               |                                     |             | A52                                    | A64 | FT   | YT   | L    | C    |
| 1/6,S1/4        | 0.1~1K                    | 100V                        | 150V                          | 200V                                | ±350ppm/°C  | 5000                                   | -   | -    | -    | -    | -    |
| 1/4,1/3         | 0.1~15K                   | 250V                        | 300V                          | 250V                                |             | 2500                                   | -   | 2000 | 2000 | 2500 | 2500 |
| S1/2,S1,P2      | 0.1~33K                   | 250V                        | 300V                          | 250V                                |             | 2500                                   | -   | 1000 | 1000 | 2500 | 2500 |
| 1/2             | 0.1~4.7K                  | 250V                        | 300V                          | 300V                                |             | 2000                                   | -   | 1000 | 1000 | 2500 | 2500 |
| 1,2,S2,S3       |                           | 350V                        | 500V                          | 300V                                |             | 1000                                   | 500 | 1000 | 1000 | 1000 | 1000 |

## 結構圖 Construction

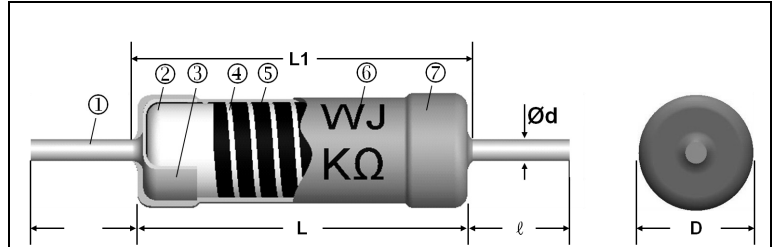

|   |     |                        |   |       |                       |
|---|-----|------------------------|---|-------|-----------------------|
| 1 | 端子線 | Lead wire              | 5 | 保險型皮膜 | Fusible film          |
| 2 | 瓷棒  | Ceramic base           | 6 | 標示    | Marking or color code |
| 3 | 鐵帽  | Cap                    |   |       |                       |
| 4 | 切割線 | Helical cutting groove | 7 | 絕緣塗料  | Insulation coat       |

## 外型尺寸 Dimensions

| Rated Power (W) | Dimensions (mm) |         |         |           |      | Weight (g) (1000pcs) |
|-----------------|-----------------|---------|---------|-----------|------|----------------------|
|                 | L               | L1 Max. | D       | Ød        | l    |                      |
| 1/6,S1/4        | 3.3±0.3         | 4       | 1.7±0.3 | 0.45±0.05 | 27±3 | 120                  |
| 1/4,1/3,S1/2    | 6.0±0.3         | 7       | 2.4±0.1 | 0.6±0.05  | 28±2 | 218                  |
| 1/2,S1,P2       | 9±0.5           | 11      | 3.0±0.5 |           | 28±3 | 320                  |
| 1,S2            | 12±1            | 15      | 4.5±0.5 | 0.8±0.05  | 38±3 | 780                  |
| 2,S3            | 16±1            | 18      | 5.5±0.5 |           |      | 1450                 |

## 料號編碼 Type composition

例 Example

| RF      | U           | 14               | J             | R100              | A520         | NH            |  |
|---------|-------------|------------------|---------------|-------------------|--------------|---------------|--|
| 型名 Type | 品名 Size     | 額定功率 Rated Power | 誤差值 Tolerance | 電阻值(Ω) Resistance | 二次加工 Forming | 端子線 Lead Wire |  |
|         | U: Standard | 16:1/6W          | J±5%          | 1006=100M         | See table    | 熱鍍線           |  |
|         | S: Small    | 14:1/4W          |               | 1007=1G           | below        | Heat plated   |  |
|         |             | 12:1/2W          |               |                   |              |               |  |
|         |             | 01:1W            |               |                   |              |               |  |
|         |             | 02:2W            |               |                   |              |               |  |



■ 額定溫度下降曲線圖 Derating curve

例 Example

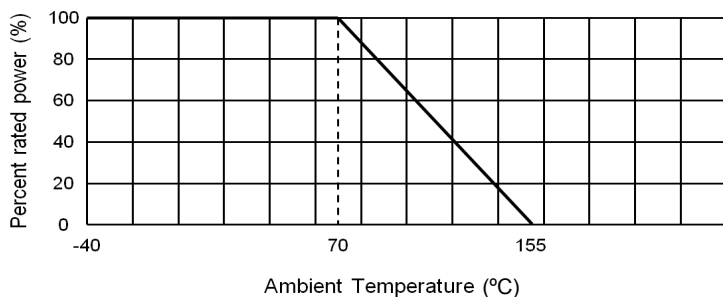

■ 熔斷特性 Fusing characteristics

殘留阻值為公稱阻值 100 倍以上 (Residual resistance  $\geq$  100 times nominal resistance)

| Rated Power (W) | Resistance Range     | $\sqrt{40PR}$        | $\sqrt{30PR}$        | $\sqrt{25PR}$       | $\sqrt{16PR}$       | Fusing Time |
|-----------------|----------------------|----------------------|----------------------|---------------------|---------------------|-------------|
| 1/6、S1/4        | 0.10 ~ 1K $\Omega$   | 0.10 ~ 0.18 $\Omega$ | 0.20 ~ 0.47 $\Omega$ | 0.51 ~ 1K $\Omega$  | -----               | 60 Sec Max  |
| 1/4、1/3         | 0.10 ~ 15K $\Omega$  | 0.10 ~ 0.22 $\Omega$ | -----                | 0.24 ~ 9.1 $\Omega$ | 10 ~ 15K $\Omega$   |             |
| S1/2、P2         | 0.10 ~ 33K $\Omega$  | -----                | -----                | 0.10 ~ 1.0 $\Omega$ | 1.1 ~ 33K $\Omega$  |             |
| S1、P2           | 0.10 ~ 33K $\Omega$  | -----                | -----                | 0.10 ~ 1.0 $\Omega$ | 1.1 ~ 33K $\Omega$  |             |
| 1/2             | 0.10 ~ 4.7K $\Omega$ | 0.10 ~ 0.33 $\Omega$ | 0.47 ~ 0.91 $\Omega$ | 1.0 ~ 9.1 $\Omega$  | 10 ~ 4.7K $\Omega$  |             |
| 1、S2            | 0.10 ~ 4.7K $\Omega$ | -----                | -----                | 0.10 ~ 1.0 $\Omega$ | 1.1 ~ 4.7K $\Omega$ |             |
| 2、S3            | 0.10 ~ 4.7K $\Omega$ | -----                | -----                | 0.10 ~ 1.0 $\Omega$ | 1.1 ~ 4.7K $\Omega$ |             |

■ 試驗條件與方法 The testing method and condition.

| 試驗項目<br>Test Items                   | 規格值<br>Performance Requirements          | 試驗方法<br>Test Methods and Standard.(JISC5201-1)  |
|--------------------------------------|--|---|
| 電阻值<br>Resistance                    | 規定的誤差值內<br>Within of specified tolerance | 測量點從端蓋 10mm<br>Measuring points are distance 10mm from the end cap(4.5)                     |
| 溫度係數<br>T.C.R.                       | 規定值內<br>Within of specified T.C.R.       | 室溫+100°C<br>Room temperature +100°C(4.8)  |
| 短時間過負荷<br>Short time overload        | $\pm(2\%+0.05\Omega)$                    | 4 倍額定功率，5 秒<br>4 times the rated power for 5 seconds  |
| 負荷壽命<br>Load life                    | $\pm(5\%+0.1\Omega)$                     | Rated voltage at 70°C for 1,000 hours<br>1.5hr ON / 0.5hr OFF Cycles(4.25.1)                |
| 耐濕負荷壽命<br>Load life in humidity      | $\pm(5\%+0.1\Omega)$                     | 10% rate power load<br>40°C, 95% RH for 1,000 hours<br>1.5h ON / 0.5h OFF cycle(4.24)       |
| 耐濕性<br>Moisture resistance           | $\pm(1\%+0.05\Omega)$                    | 40°C，95% RH，240 小時<br>40°C, 95% RH for 240 hours  |
| 溫度循環<br>Temperature cycle            | $\pm(1\%+0.05\Omega)$                    | 5 cycles for -25°C (30min) : room temp. (30min)<br>~ +85°C (30min) room temp. (30min)(4.19) |
| 焊錫效果<br>Soldeability                 | 95 % (min) coverage                      | Temp. of solder 245°C $\pm$ 5°C<br>duration of immersion 3s $\pm$ 0.5s                      |
| 焊錫耐熱<br>Resistance to soldering heat | $\pm(1\%+0.05\Omega)$                    | 260°C $\pm$ 5°C for 10 seconds (焊錫槽)<br>350°C $\pm$ 10°C for 3.5 seconds (手焊錫)(4.18)        |
| 絕緣電阻<br>Insulation resistance        | >1,000M $\Omega$                         | 500V 絕緣測試 1 分鐘<br>500V insulation test 1min.(4.6.1)   |

# RATED CURRENT FUSIBLE RESISTOR

RFA

電流式保險絲電阻器

RATED CURRENT FUSIBLE RESISTOR (Standard Type)



塗料顏色 (Coating Color) :  
標準品 (Standard Type) Gray  
標示 (Color Code)

## 特性 Feature

◎使用不燃性塗料,具不燃與絕緣之安全特性(UL94 V-0)  
Flameproof and insulating coating designed to assure safe usage by special non-flammable silicon-base.  
(Equivalent to UL94 V-0)

◎電流式保險絲提供電阻器熔斷遲延的性能及在定電流作業下的高穩定性  
The rated current fusible resistor combines time delay performance Characteristics with the proven reliability of a rated current fusible.

◎產品符合歐盟 RoHS 要求  
Products is compliance the EU-RoHS request.

## 參考規格 Reference standards

● JIS C 5201-1

## 二次加工對應表 Taping & Forming Matrix

| Rated Current (A) | Taping |     |     | Radial Taping |    | L Forming |       |     |     |     | C Forming |     |     |     | F Forming |     |     |     | M Forming |     |     | D Forming |     |     |
|-------------------|--------|-----|-----|---------------|----|-----------|-------|-----|-----|-----|-----------|-----|-----|-----|-----------|-----|-----|-----|-----------|-----|-----|-----------|-----|-----|
|                   | A52    | A64 | A73 | FT            | YT | L10       | L12.5 | L15 | L20 | L30 | C12.5     | C15 | C20 | C30 | FA5       | FB5 | FC5 | FD5 | M12.5     | M15 | M20 | D12.5     | D15 | D20 |
| ≤ 3A              | ○      | -   | -   | ○             | -  | ○         | -     | -   | -   | -   | -         | -   | -   | -   | -         | -   | -   | -   | ○         | -   | -   | ○         | -   | -   |
| > 3A              | ○      | -   | -   | ○             | ○  | -         | ○     | -   | -   | -   | ○         | -   | -   | -   | ○         | ○   | ○   | ○   | -         | ○   | -   | -         | ○   | -   |

## 額定 Ratings

| Rated Current (A) | 耐電壓 Dielectric Withstanding Voltage | 溫度係數 T.C.R. | 包裝 Taping/Ammo, Forming/Bulk pack(pcs) |     |      |      |      |      |  |
|-------------------|-------------------------------------|-------------|--|-----|------|------|------|------|--|
|                   |                                     |             | A52                                    | A64 | FT   | YT   | L    | C    |  |
| ≤ 3A              | 100V                                | ±350ppm/°C  | 2500                                   | -   | 2000 | 2000 | 2500 | 2500 |  |
| > 3A              |                                     |             | 2000                                   | -   | 1000 | 1000 | 2500 | 2500 |  |

## 熔斷特性 Fusing characteristics

| 額定電流% Percentage of Ampere Rating | 熔斷時間 Opening Time          |
|-----------------------------------|----------------------------|
| 100%                              | 4Hours Min                 |
| 200%                              | 1 second~60second Max      |
| 300%                              | 0.2 second~3 second Max    |
| 800%                              | 0.02 second~0.2 second Max |

殘留阻值為公稱阻值 100 倍以上(Residual resistance ≥ 100 times nominal resistance)

## 結構圖 Construction

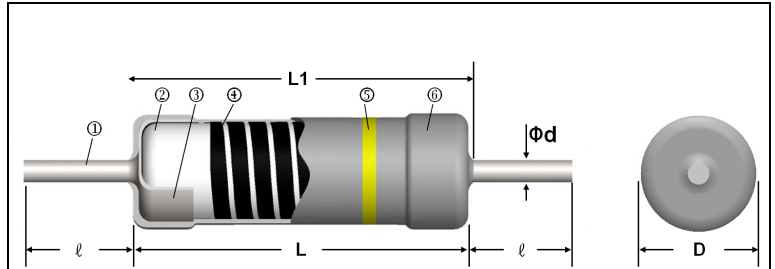

|   |     |                        |   |       |                 |
|---|-----|------------------------|---|-------|-----------------|
| 1 | 端子線 | Lead wire              | 5 | 保險型皮膜 | Fusible film    |
| 2 | 瓷棒  | Ceramic base           | 6 | 標示    | color code      |
| 3 | 鐵帽  | Cap                    | 7 | 絕緣塗料  | Insulation coat |
| 4 | 切割線 | Helical cutting groove |   |       |                 |

## 外型尺寸 Dimensions

| Rated Current (A) | Dimensions (mm) |         |         |          |      | Weight (g) (1000pcs) |
|-------------------|-----------------|---------|---------|----------|------|----------------------|
|                   | L               | L1 Max. | D       | Ød       | l    |                      |
| ≤ 3A              | 6.0±0.3         | 7       | 2.4±0.1 | 0.6±0.05 | 28±2 | 218                  |
| > 3A              | 9±0.5           | 11      | 3.0±0.5 |          | 28±3 | 320                  |

## 料號編碼 Type composition

例 Example

| RF      | A       | 00       | J                    | A100   | A520            | NH              |
|---------|---------|----------|----------------------|--|-----------------|-----------------|
| 型名 Type | 品名 Size | 空欄 Blank | 誤差值 Tolerance        | 電阻值(Ω) Resistance                            | 二次加工 Forming    | 端子線 Lead Wire   |
|         |         | 無註記      | F±1%<br>G±2%<br>J±5% | A100=0.1A<br>1A50=1.5A<br>3A00=3A<br>7A00=7A | See table below | 熱鍍線 Heat plated |

## 額定電流電阻表面溫度曲線

Curve of temp. rise and rated current

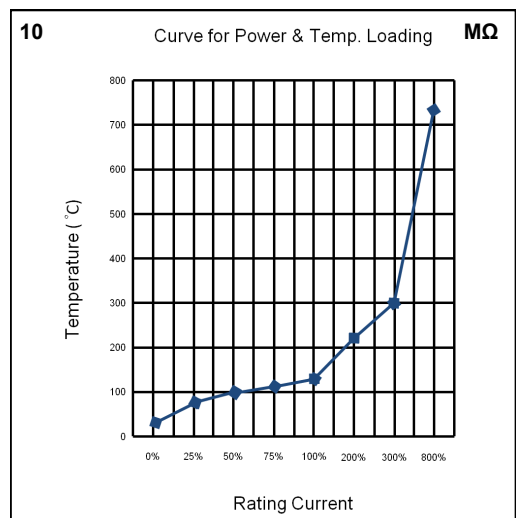

### ■ 額定溫度下降曲線圖 Derating curve

例 Example

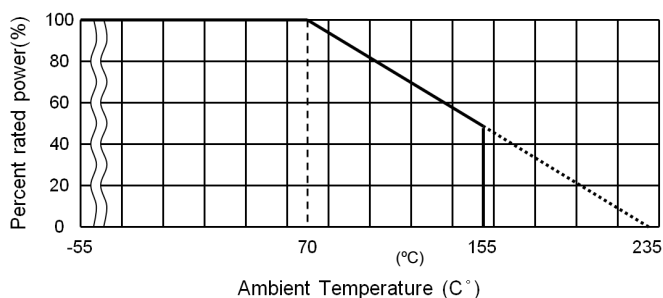

### ■ 定電流熔斷曲線 Fuse curve of rated current

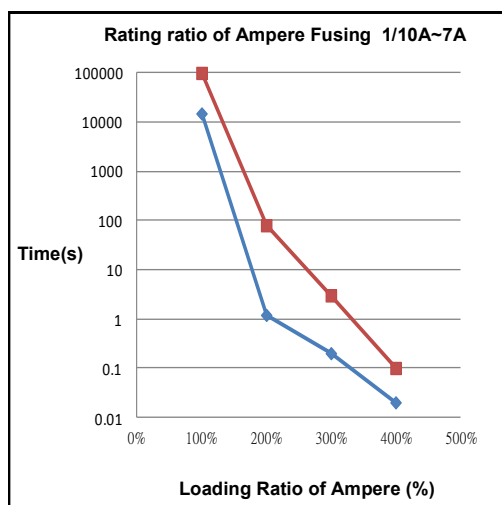

### ■ 訂購資訊 Ordering information

| Order | Amperes | Voltage | Body  | Melting |
|-------|---------|---------|-------|---------|
| A250  | 1/4     | 125     | 25*65 | 0.125   |
| A375  | 3/8     | 125     | 25*65 | 0.28    |
| A500  | 1/2     | 125     | 25*65 | 0.50    |
| A750  | 3/4     | 125     | 25*65 | 1.12    |
| 1A00  | 1.00    | 125     | 25*65 | 2.00    |
| 1A50  | 1.1/2   | 125     | 25*65 | 5.50    |
| 2A00  | 2.00    | 125     | 25*65 | 8.00    |
| 2A25  | 2.1/4   | 125     | 25*65 | 10.12   |
| 2A50  | 2.1/2   | 125     | 25*65 | 12.50   |
| 3A00  | 3.00    | 125     | 25*65 | 18.0    |
| 3A15  | 3.15    | 125     | 25*65 | 20.0    |
| 4A00  | 4.00    | 125     | 28*92 | 32.0    |
| 5A00  | 5.00    | 125     | 28*92 | 50.0    |
| 7A00  | 7.00    | 125     | 28*92 | 98.0    |

### ■ 試驗條件與方法 The testing method and condition.

| 試驗項目<br>Test Items                   | 規格值<br>Performance Requirements           | 試驗方法<br>Test Methods and Standard.(JISC5201-1)   |
|--------------------------------------|---|--|
| 電阻值<br>Resistance                    | 規定的誤差值內<br>Within of specified tolerance  | 測量點從端蓋 10mm<br>Measuring points are distance 10mm from the end cap(4.5)                          |
| 溫度係數<br>T.C.R.                       | 規定值內<br>Within of specified T.C.R.        | 室溫+100°C<br>Room temperature +100°C(4.8)   |
| 短時間過負荷<br>Short time overload        | ±(2%+0.05Ω)                               | 4 倍額定功率，5 秒<br>4 times the rated power for 5 seconds   |
| 負荷壽命<br>Load life                    | ±(5%+0.1Ω)                                | Rated voltage at 70°C for 1,000 hours<br>1.5hr ON / 0.5hr OFF Cycles(4.25.1)                     |
| 耐濕負荷壽命<br>Load life in humidity      | ±(5%+0.1Ω)                                | 10% rate power load<br>40°C, 95% RH for 1,000 hours<br>1.5h ON / 0.5h OFF cycle(4.24)            |
| 耐濕性<br>Moisture resistance           | ±(1%+0.05Ω)                               | 40°C，95% RH，240 小時<br>40°C, 95% RH for 240 hours   |
| 溫度循環<br>Temperature cycle            | ±(1%+0.05Ω)                               | 5 cycles for -25°C (30min) ; room temp. (30min)<br>~ +85°C (30min) room temp. (30min)(4.19)      |
| 焊錫效果<br>Soldeability                 | 95 % (min) coverage                       | Temp. of solder 245°C ± 5°C<br>duration of immersion 3s±0.5s                                     |
| 焊錫耐熱<br>Resistance to soldering heat | ±(1%+0.05Ω)                               | 260°C ±5°C for 10 seconds (焊錫槽)<br>350°C±10°C for 3.5 seconds (手焊錫)                              |
| 絕緣電阻<br>Insulation resistance        | >1,000MΩ                                  | 500V 絕緣測試 1 分鐘<br>500V insulation test 1min.(4.6.1)  |
| 不燃性<br>Flameproof                    | 無燃燒現象<br>No evidence of flaming or arcing | AC voltage of 2,4,8,16,32 times the power<br>rating for 1min. (V ≤ 4 times max. working voltage) |

# FUSING RESISTOR

**WFU** 高能量突波繞線保險絲電阻器  
FUSIBLE RESISTOR (Standard Type)

**WFS** 小型高能量突波繞線保險絲電阻器  
HEAT ENERGY SURGE WIRE WOUND FUSIBLE RESISTOR (Small Type)

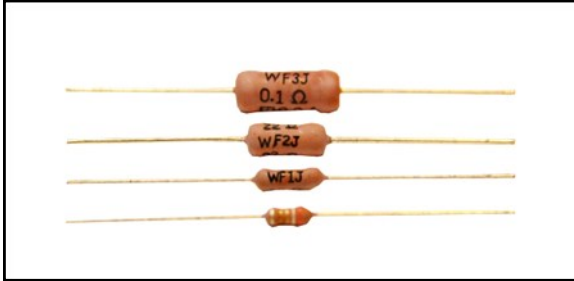

塗料顏色 (Coating Color):

標準品 (Standard Type) Gray

小型品 (Small Type) Pink

標示 (Marking):

色碼 (Color Code) S1/2W

文字 (Alphanumeric) 1/2W~S3W

## 特性 Feature

◎電壓式繞線保險絲提供高突波能量的特性，準確的熔

斷性能，及在額定功率下作業的高穩定性

The voltage type wire wound fusible resistor can provide reliable fusing behavior stable performance and endurance to surge voltage.

◎產品符合歐盟 RoHS 要求

Products is compliance the EU-RoHS request.

## 參考規格 Reference standards

● JIS C 5201-1

## 結構圖 Construction

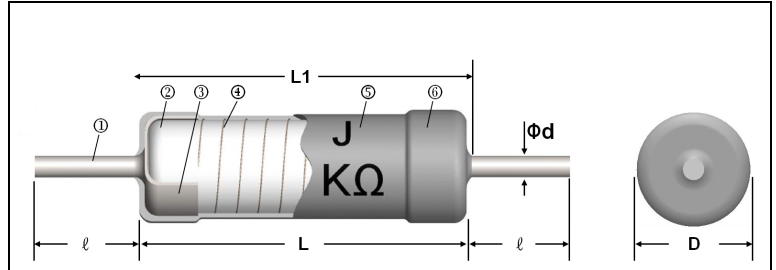

|   |     |              |   |      |                       |
|---|-----|--------------|---|------|-----------------------|
| 1 | 端子線 | Lead wire    | 4 | 繞線   | Wire wound            |
| 2 | 瓷棒  | Ceramic base | 5 | 標示   | Marking or color code |
| 3 | 鐵帽  | Cap          | 6 | 絕緣塗料 | Insulation coat       |

## 外型尺寸 Dimensions

| Rated Power (W) | Dimensions (mm) |         |         |          |      | Weight (g) (1000pcs) |
|-----------------|-----------------|---------|---------|----------|------|----------------------|
|                 | L               | L1 Max. | D       | Ød       | ℓ    |                      |
| S1/2            | 6.0±0.3         | 7       | 2.4±0.1 | 0.6±0.05 | 28±3 | 200                  |
| 1/2,S1          | 9.0±0.5         | 11      | 3.0±0.5 |          |      | 285                  |
| 1,S2            | 12±1            | 15      | 4.5±0.5 | 0.8±0.05 | 38±3 | 728                  |
| 2,S3            | 16±1            | 18      | 5.5±0.5 |          |      | 1380                 |

## 料號編碼 Type composition

例 Example

| WF      | U           | 12               | J             | R100              | A520         | NH              |
|---------|-------------|------------------|---------------|-------------------|--------------|-----------------|
| 型名 Type | 品名 Size     | 額定功率 Rated Power | 誤差值 Tolerance | 電阻值(Ω) Resistance | 二次加工 Forming | 端子線 Lead Wire   |
|         | U: Standard | 12:1/2W          | J±5%          | R100=0.1          | See table    | 熱鍍線 Heat plated |
|         | S: Small    | 01:1W            |               | 1R00=1            |              |                 |
|         |             | 02:2W            |               | 10R0=10           |              |                 |
|         |             | 03:3W            |               | 1000=100          |              |                 |

## 二次加工對應表 Taping & Forming Matrix

| Rated Power (W) | Taping |     |     | Radial Taping |    | L Forming |       |     |     |     | C Forming |     |     |     | F Forming |     |     |     | M Forming |     |     | D Forming |     |     |   |
|-----------------|--------|-----|-----|---------------|----|-----------|-------|-----|-----|-----|-----------|-----|-----|-----|-----------|-----|-----|-----|-----------|-----|-----|-----------|-----|-----|---|
|                 | A52    | A64 | A73 | FT            | YT | L10       | L12.5 | L15 | L20 | L30 | C12.5     | C15 | C20 | C30 | FA5       | FB5 | FC5 | FD5 | M12.5     | M15 | M20 | D12.5     | D15 | D20 |   |
| S1/2            | ○      | -   | -   | ○             | -  | ○         | -     | -   | -   | -   | -         | -   | -   | -   | ○         | ○   | ○   | ○   | -         | -   | -   | -         | -   | -   | - |
| 1/2,S1          | ○      | -   | -   | ○             | ○  | -         | ○     | -   | -   | -   | ○         | -   | -   | -   | ○         | ○   | ○   | ○   | ○         | -   | -   | -         | ○   | -   | - |
| 1,S2            | ○      | ○   | -   | ○             | ○  | -         | -     | ○   | -   | -   | -         | ○   | -   | -   | ○         | ○   | ○   | ○   | -         | ○   | -   | -         | ○   | -   | - |
| 2,S3            | -      | ○   | -   | -             | ○  | -         | -     | -   | ○   | -   | -         | -   | ○   | -   | ○         | ○   | ○   | ○   | -         | -   | ○   | -         | -   | -   | ○ |

## 額定 Ratings

| Rated Power (W) | 阻值範圍 Resistance Range (Ω) |  | 最高使用電壓 Max. Working Voltage | 最高過負荷電壓 Max. Overload Voltage | 耐電壓 Dielectric Withstanding Voltage | 溫度係數 T.C.R.                                    | 包裝 Taping/Ammo, Forming/Bulk pack (pcs) |      |      |      |      |      |
|-----------------|---------------------------|--|-----------------------------|-------------------------------|-------------------------------------|--|---|------|------|------|------|------|
|                 | J±5% (E24)                |  |                             |                               |                                     |  | A52                                     | A64  | FT   | YT   | L    | C    |
| S1/2            | 0.1 ~ 150                 |  | 100V                        | 150V                          | 100V                                | ≤ 1Ω :<br>± 500ppm/°C<br>> 1Ω :<br>± 300ppm/°C | 2500                                    | -    | 2000 | 2000 | 2500 | 2500 |
| 1/2,S1          |                           |  |                             |                               |                                     |  | 2000                                    | -    | 1000 | 2000 | 2500 | 2500 |
| 1,S2            |                           |  |                             |                               |                                     |  | 1000                                    | 1000 | 1000 | 1000 | 1000 | 1000 |
| 2,S3            |                           |  |                             |                               |                                     |  | 500                                     | 500  | 1000 | 1000 | 1000 | 1000 |

■ 額定溫度下降曲線圖 Derating curve

例 Example

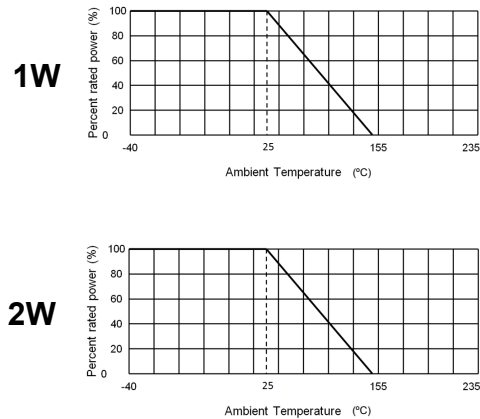

■ 突波特性

例 Example

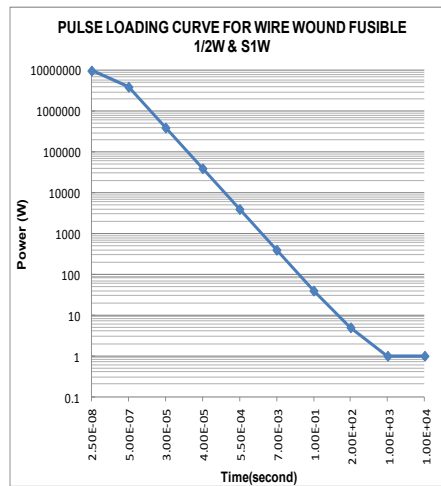

■ 額定功率表面溫升

Surface Temperature Rise  
Vs. Loaded Power

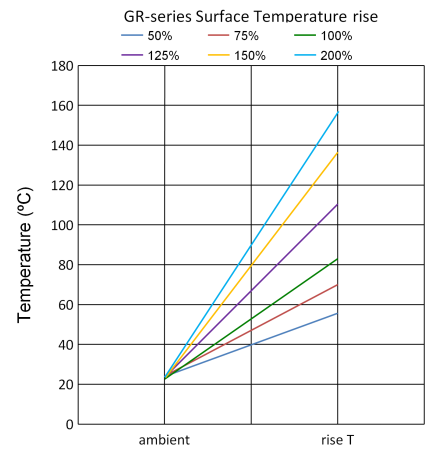

■ 熔斷特性 Fusing characteristics

殘留阻值為公稱阻值 100 倍以上 (Residual resistance  $\geq$  100 times nominal resistance)

| Power Rating<br>I=constant | Opening Time       | 1/2W<br>&<br>S1W | Power Rating<br>I=constant | Opening Time | 1W<br>&<br>S2W<br>&<br>P3W | Power Rating<br>I=constant | Opening Time | 2W<br>&<br>S3W |
|----------------------------|--------------------|------------------|----------------------------|--------------|----------------------------|----------------------------|--------------|----------------|
| 16W                        | 10 sec Min         |                  | 24W                        | 10 sec Min   |                            | 23W                        | 10 sec Min   |                |
| 18W                        | 3sec ~ 60 sec Max  | 28W              | 8sec ~ 45 sec Max          | 40W          | 10sec ~ 30 sec Max         |                            |              |                |
| 20W                        | 2 sec ~ 30 sec Max | 32W              | 5 sec ~ 30 sec Max         | 48W          | 3 sec ~ 8 sec Max          |                            |              |                |
| 22W                        | 1sec ~ 15sec Max   | 36W              | 2sec ~ 15sec Max           | 60W          | 2sec ~ 5sec Max            |                            |              |                |

■ 試驗條件與方法 The testing method and condition.

| 試驗項目<br>Test Items              | 規格值<br>Performance Requirements           | 試驗方法<br>Test Methods and Standard.(JISC5201-1)   |
|---------------------------------|---|--|
| 電阻值<br>Resistance               | 規定的誤差值內<br>Within of specified tolerance  | 測量點從端蓋 10mm<br>Measuring points are distance 10mm from the end cap(4.5)                                |
| 溫度係數<br>T.C.R.                  | 規定值內<br>Within of specified T.C.R.        | 室溫+100°C<br>Room temperature +100°C(4.8)   |
| 短時間過負荷<br>Short time overload   | $\pm(1\%+0.05\Omega)$                     | 4 倍額定功率，5 秒<br>4 times the rated power for 5 seconds   |
| 負荷壽命<br>Load life               | $\pm(5\%+0.1\Omega)$                      | Rated voltage at 70°C for 1,000 hours<br>1.5hr ON / 0.5hr OFF Cycles(4.25.1)                           |
| 耐濕負荷壽命<br>Load life in humidity | $\pm(5\%+0.1\Omega)$                      | 10% rate power load<br>40°C, 95% RH for 1,000 hours<br>1.5h ON / 0.5h OFF cycle(4.24)                  |
| 耐濕性<br>Moisture resistance      | $\pm(1\%+0.05\Omega)$                     | 40°C, 95% RH, 240 小時<br>40°C, 95% RH for 240 hours   |
| 溫度循環<br>Temperature cycle       | $\pm(1\%+0.05\Omega)$                     | 5 cycles for -25°C (30min) : room temp. (30min)<br>~ +85°C (30min) room temp. (30min)(4.19)            |
| 焊錫效果<br>Soldeability            | 95 % (min) coverage                       | Temp. of solder 245°C $\pm$ 5°C<br>duration of immersion 5s $\pm$ 0.5s                                 |
| 絕緣電阻<br>Insulation resistance   | >1,000M $\Omega$                          | 500V 絕緣測試 1 分鐘<br>500V insulation test 1min.(4.6.1)  |
| 不燃性<br>Flameproof               | 無燃燒現象<br>No evidence of flaming or arcing | AC voltage of 2,4,8,16,32 times the power<br>rating for 1min. ( $V \leq$ 4 times max. working voltage) |

# NON-SMOKE THERMAL FUSE RESISTOR

## RFT 水泥繞線電阻組合溫度保險絲電阻器 NON-SMOKE THERMAL FUSE RESISTOR (RFT Type)

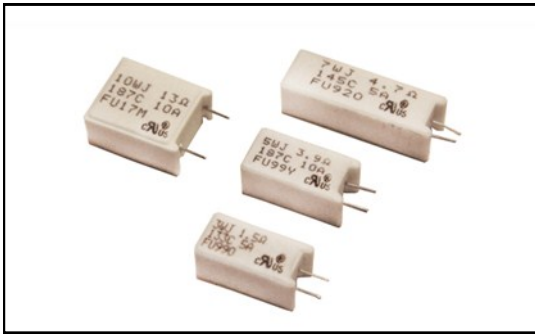

本體顏色 (Body color) :  
白色 (White)  
標示 (Marking) :  
文字 (Alphanumeric)

### 特性 Feature

- ◎不燃與絕緣之安全設計  
Compact type with safety design of Non-flammability and insulation.
- ◎可依客戶需求製作  
Can be produced according to customer's request.
- ◎產品符合歐盟 RoHS 要求  
Products is compliance the EU-RoHS request.

### 產品認證 Approvals awarded

- UL 1412 File No.E257690 CUL  
UL1412 Recognized :  $\leq 145^{\circ}\text{C}$  / 3W、5W、7W、10W /  
0.1 $\Omega$ ~ 1K $\Omega$

### 參考規格 Reference standards

- JIS C 5201-1

### 額定 Ratings

| Thermal Fuse            |                    |                | Power Rating (W) |     |     |          | 耐電壓 Dielectric Withstanding Voltage | 溫度係數 T.C.R.                          |
|-------------------------|--------------------|----------------|------------------|-----|-----|----------|-------------------------------------|--------------------------------------|
| Temperature Function Tf | Thermal Fuse Temp. | Voltage Rating | 3W               | 5W  | 7W  | 10W、10WS |                                     |                                      |
| 65                      | 61 $\pm$ 3         | AC 250V        | 0.3              | 0.4 | 0.6 | 0.7      | 1000V                               | $\pm 350\text{ppm}/^{\circ}\text{C}$ |
| 76                      | 72 $\pm$ 3         |                | 0.5              | 0.6 | 0.8 | 1        |                                     |                                      |
| 86                      | 81 $\pm$ 2         |                | 0.6              | 0.8 | 1   | 1.3      |                                     |                                      |
| 102                     | 98 $\pm$ 3         |                | 0.9              | 1.1 | 1.4 | 1.7      |                                     |                                      |
| 115                     | 111 $\pm$ 2        |                | 1.1              | 1.4 | 1.7 | 2.1      |                                     |                                      |
| 127                     | 123 $\pm$ 2        |                | 1.3              | 1.7 | 2   | 2.5      |                                     |                                      |
| 133                     | 129 $\pm$ 3        |                | 1.5              | 2   | 2.4 | 3        |                                     |                                      |
| 136                     | 131 $\pm$ 2        |                | 1.6              | 2.1 | 2.6 | 3.2      |                                     |                                      |
| 139                     | 134 $\pm$ 2        |                | 1.7              | 2.2 | 2.7 | 3.3      |                                     |                                      |
| 145                     | 140 $\pm$ 2        |                | 1.8              | 2.3 | 2.8 | 3.5      |                                     |                                      |
| 187                     | 182 $\pm$ 2        |                | 1.8              | 2.3 | 3.3 | 4.6      |                                     |                                      |
| 192                     | 187 $\pm$ 2        |                | 1.8              | 2.3 | 3.3 | 4.6      |                                     |                                      |
| 219                     | 215 $\pm$ 2        |                | 1.8              | 2.3 | 3.3 | 4.6      |                                     |                                      |

### 結構圖 Construction

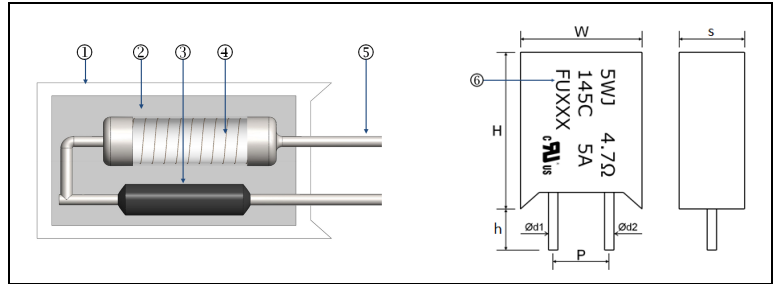

|   |       |                |   |     |           |
|---|-------|----------------|---|-----|-----------|
| 1 | 瓷殼    | Ceramic case   | 4 | 電阻器 | Resistor  |
| 2 | 矽水泥   | Silicon cement | 5 | 端子線 | Lead wire |
| 3 | 溫度保險絲 | Thermal fuse   | 6 | 標示  | Marking   |

### 外型尺寸 Dimensions

| Rated Power (W) | Dimensions (mm) |           |           |           |           |                 |                 |
|-----------------|-----------------|-----------|-----------|-----------|-----------|-----------------|-----------------|
|                 | H $\pm$ 1       | W $\pm$ 1 | h $\pm$ 1 | P $\pm$ 1 | s $\pm$ 1 | Fuse: $\phi$ d1 | Wire: $\phi$ d2 |
| 2               | 20              | 12        | 5         | 5         | 7         | 0.6 $\pm$ 0.1   | 0.8 $\pm$ 0.1   |
| 3               | 25              | 12        | 5         | 5         | 9         | 1.0 $\pm$ 0.1   | 0.8 $\pm$ 0.1   |
| 5               | 25              | 13.5      | 5         | 5         | 9         | 1.0 $\pm$ 0.1   | 0.8 $\pm$ 0.1   |
| 7               | 39              | 13        | 5         | 5         | 9         | 1.0 $\pm$ 0.1   | 0.8 $\pm$ 0.1   |
| 10              | 25              | 20        | 5         | 12        | 9         | 0.8 $\pm$ 0.1   | 0.8 $\pm$ 0.1   |
| 10s             | 35              | 16        | 5         | 7         | 12        | 1.0 $\pm$ 0.1   | 0.8 $\pm$ 0.1   |

### 料號編碼 Type composition

例 Example

| RF      | T           | 03                                | J   | 10R0                          | T133                             | NH              |
|---------|-------------|-----------------------------------|---|-------------------------------|----------------------------------|-----------------|
| 型名 Type | 品名 Size     | 額定功率 Rated Power                  | 誤差值 Tolerance   | 電阻值( $\Omega$ ) Resistance    | 溫度 Temperature                   | 端子線 Lead Wire   |
|         | 溫度型 Thermal | 03:3W<br>05:5W<br>07:7W<br>A0:10W | F $\pm$ 1%<br>G $\pm$ 2%<br>J $\pm$ 5%<br>K $\pm$ 10% | 1R00=1<br>10R0=10<br>1000=100 | T133 :<br>133 $^{\circ}\text{C}$ | 熱鍍線 Heat plated |

■ 額定溫度下降曲線圖 Derating curve

例 Example

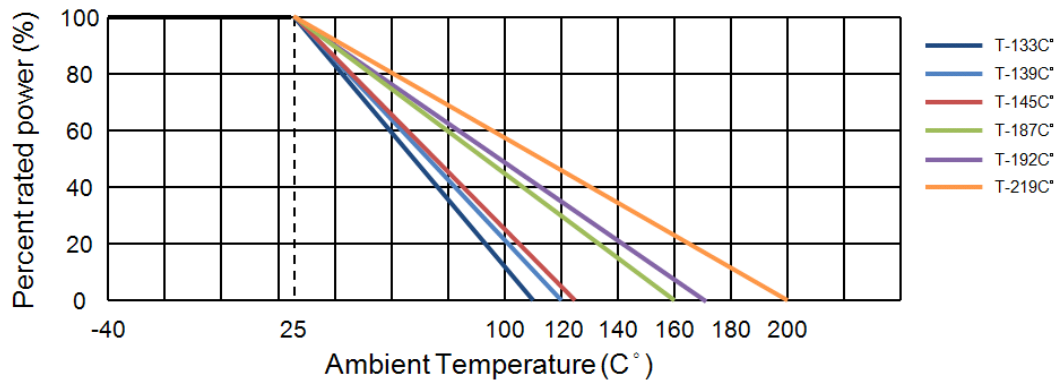

試驗條件與方法 The testing method and condition.

| 試驗項目<br>Test Items                   | 規格值<br>Performance Requirements          | 試驗方法<br>Test Methods and Standard.(JISC5201-1)  |
|--------------------------------------|--|---|
| 電阻值<br>Resistance                    | 規定的誤差值內<br>Within of specified tolerance | 測量點從端蓋 10mm<br>Measuring points are distance 10mm from the end cap(4.5)                     |
| 溫度係數<br>T.C.R.                       | 規定值內<br>Within of specified T.C.R.       | 試驗溫度 70°C，30 分鐘<br>70°C (30min)   |
| 短時間過負荷<br>Short time overload        | ±(2%+0.05Ω)                              | √4PR 倍額定功率，5 秒<br>√4PR times the rated power for 5 seconds                                  |
| 負荷壽命<br>Load life                    | ±(5%+0.1Ω)                               | Rated voltage at 70°C for 1,000 hours<br>1.5hr ON / 0.5hr OFF Cycles(4.25.1)                |
| 耐濕負荷壽命<br>Load life in humidity      | ±(5%+0.1Ω)                               | 10% rate power load<br>40°C, 95% RH for 1,000 hours<br>1.5h ON / 0.5h OFF cycle(4.24)       |
| 耐濕性<br>Moisture resistance           | ±(2%+0.05Ω)                              | 40°C，95% RH，240 小時<br>40°C, 95% RH for 240 hours  |
| 溫度循環<br>Temperature cycle            | ±(1%+0.05Ω)                              | 5 cycles for -25°C (30min) : room temp. (30min)<br>~ +85°C (30min) room temp. (30min)(4.19) |
| 焊錫耐熱<br>Resistance to soldering heat | ±(1%+0.05Ω)                              | 260°C ± 5°C for 10 seconds (焊錫槽)<br>350°C ± 10°C for 3.5 seconds (手焊錫)(4.18)                |
| 絕緣電阻<br>Insulation resistance        | >1,000MΩ                                 | 500V 絕緣測試 1 分鐘<br>500V insulation test 1min.(4.6.1)   |

# FUSING RESISTOR

**RFB** 防爆保險絲電阻器  
ANTI-BURST FUSIBLE RESISTOR (Wire Type)

**RFF** 防爆保險絲電阻器  
ANTI-BURST FUSIBLE RESISTOR (Film Type)



本體顏色 (Body Color) :  
白色 (White)  
標示 (Marking) :  
色碼 (Color Code) (1/4W)  
文字 (Alphanumeric) (1/2W~3W)

## 結構圖 Construction

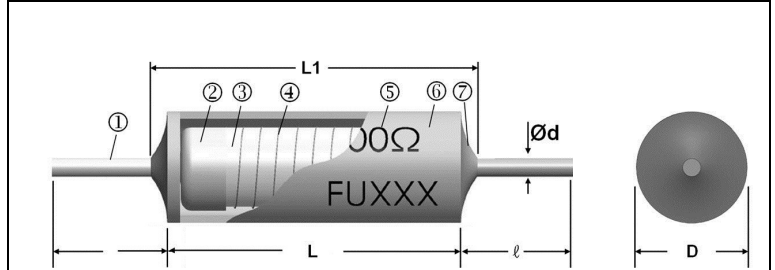

|   |     |              |   |      |                 |
|---|-----|--------------|---|------|-----------------|
| 1 | 端子線 | Lead wire    | 5 | 標示   | Marking         |
| 2 | 鐵帽  | Cap          | 6 | 瓷管   | Ceramic tube    |
| 3 | 瓷棒  | Ceramic base |   |      |                 |
| 4 | 繞線  | Wire wound   | 7 | 絕緣塗料 | Insulation coat |

## 特性 Feature

- ◎ 防爆式繞線保險絲或防爆式皮膜保險絲  
The ANTI-BURST Type wire wound or film type fusible.
- ◎ 提供無爆裂與保護環境的安全熔斷特性，準確的熔斷性能  
Resistors can provide reliable and environmentally safe fusing behavior.
- ◎ 在額定功率下作業的持久高穩定性  
Reliable performance and endurance to surge voltage.
- ◎ 產品符合歐盟 RoHS 要求  
Products is compliance the EU-RoHS request.

## 外型尺寸 Dimensions

| Rated Power (W) | Dimensions (mm) |         |         |          |      | Weight (g)<br>(1000pcs) |
|-----------------|-----------------|---------|---------|----------|------|-------------------------|
|                 | L               | L1 Max. | D       | Ød       | ℓ    |                         |
| 1/4             | 6.6±0.5         | 10      | 3.6±0.5 | 0.6±0.05 | 26±2 | 310                     |
| 1/2             | 11±1            | 14      | 4.3±0.5 |          |      | 490                     |
| 1               | 11±1            | 14      | 4.3±0.5 |          |      | 490                     |
| 2               | 13±1            | 16      | 5.5±0.5 | 0.8±0.05 | 30±3 | 1250                    |
| 3               | 17±1            | 20      | 7.0±0.5 |          |      | 35±3                    |

## 料號編碼 Type composition 例 Example

| RF         | B          | 14                  | J                | R100                 | A520               | NH                 |
|------------|------------|---------------------|------------------|----------------------|--------------------|--------------------|
| 型名<br>Type | 品名<br>Size | 額定功率<br>Rated Power | 誤差值<br>Tolerance | 電阻值(Ω)<br>Resistance | 二次加工<br>Forming    | 端子線<br>Lead Wire   |
|            | B: Wire    | 14:1/4W             | J±5%             | R100=0.1             | See table<br>below | 熱鍍線<br>Heat plated |
|            | F: Film    | 12:1/2W             |                  | 1R00=1               |                    |                    |
|            |            | 01:1W               |                  | 10R0=10              |                    |                    |
|            |            | 02:2W               |                  | 1000=100             |                    |                    |
|            |            | 03:3W               |                  |                      |                    |                    |

## 產品認證 Approvals awarded

- UL 1412 File No.E257690

## 參考規格 Reference standards

- JIS C 5201-1

## 二次加工對應表 Taping & Forming Matrix

| Rated Power (W) | Taping |     |     | Radial Taping |    | L Forming |       |     |     |     | C Forming |     |     | F Forming |     |     |     | M Forming |       |     | D Forming |       |     |     |   |
|-----------------|--------|-----|-----|---------------|----|-----------|-------|-----|-----|-----|-----------|-----|-----|-----------|-----|-----|-----|-----------|-------|-----|-----------|-------|-----|-----|---|
|                 | A52    | A64 | A73 | FT            | YT | L10       | L12.5 | L15 | L20 | L30 | C12.5     | C15 | C20 | C30       | FA5 | FB5 | FC5 | FD5       | M12.5 | M15 | M20       | D12.5 | D15 | D20 |   |
| 1/4             | ○      | -   | -   | -             | -  | -         | -     | -   | -   | -   | -         | -   | -   | -         | -   | -   | -   | -         | -     | -   | -         | -     | -   | -   | - |
| 1/2,1           | ○      | -   | -   | -             | -  | -         | -     | ○   | -   | -   | -         | ○   | -   | -         | ○   | ○   | ○   | ○         | -     | ○   | -         | -     | -   | ○   | - |
| 2               | -      | ○   | -   | -             | -  | -         | -     | -   | ○   | -   | -         | ○   | -   | ○         | ○   | ○   | ○   | ○         | -     | -   | ○         | -     | -   | -   | ○ |
| 3               | -      | -   | -   | -             | -  | -         | -     | -   | -   | -   | -         | -   | -   | -         | -   | -   | -   | -         | -     | -   | -         | -     | -   | -   | - |

## 額定 Ratings

| Rated Power (W) | 阻值範圍 Resistance Range (Ω) |  | 最高使用電壓<br>Max. Working Voltage | 最高過負荷電壓<br>Max. Overload Voltage | 耐電壓 Dielectric<br>Withstanding Voltage | 溫度係數<br>T.C.R.                                 | 包裝 Taping/Ammo,Forming/Bulk pack (pcs) |     |    |    |      |      |
|-----------------|---------------------------|--|--------------------------------|----------------------------------|--|--|--|-----|----|----|------|------|
|                 | J±5% (E24)                |  |                                |                                  |  |  | A52                                    | A64 | FT | YT | L    | C    |
| 1/4             | 0.1 ~ 100                 |  | 250V                           | 500V                             | 1,500V                                 | ≤ 1Ω :<br>± 500ppm/°C<br>> 1Ω :<br>± 300ppm/°C | 1000                                   | -   | -  | -  | -    | -    |
| 1/2             |                           |  |                                |                                  |  |  | 1000                                   | -   | -  | -  | 2500 | 2500 |
| 1               |                           |  |                                |                                  |  |  | 1000                                   | -   | -  | -  | 1000 | 1000 |
| 2               |                           |  |                                |                                  |  |  | -                                      | 500 | -  | -  | 1000 | 1000 |
| 3               |                           |  |                                |                                  |  |  | -                                      | -   | -  | -  | -    | -    |



■ 額定溫度下降曲線圖 Derating curve

例 Example

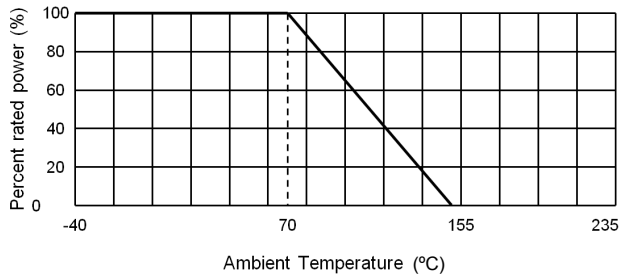

■ 熔斷特性 Fusing characteristics (參考用 Reference)

殘留阻值為公稱阻值 100 倍以上 (Residual resistance  $\geq$  100 times nominal resistance)

| 1/4W | Power Rating<br>I=constant | Opening Time       | 1/2W<br>&<br>1W    | Power Rating<br>I=constant | Opening Time       | 2W<br>&<br>3W | Power Rating<br>I=constant | Opening Time       |
|------|----------------------------|--------------------|--------------------|----------------------------|--------------------|---------------|----------------------------|--------------------|
|      | 45W                        | 8 sec ~ 40 sec Max |                    | 20W                        | 8 sec ~ 35 sec Max |               | 30W                        | 5 sec ~ 35 sec Max |
| 50W  | 3 sec ~ 15 sec Max         | 25W                | 5 sec ~ 20 sec Max | 35W                        | 2 sec ~ 10 sec Max |               |                            |                    |
| 55W  | 2sec ~ 8sec Max            | 30W                | 2sec ~ 10sec Max   | 40W                        | 1sec ~ 5sec Max    |               |                            |                    |

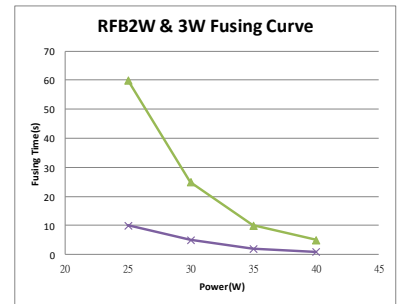
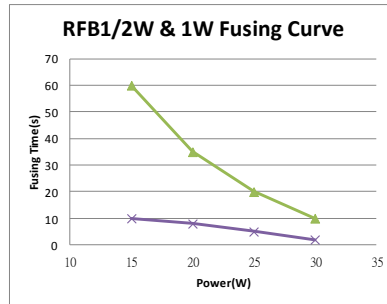
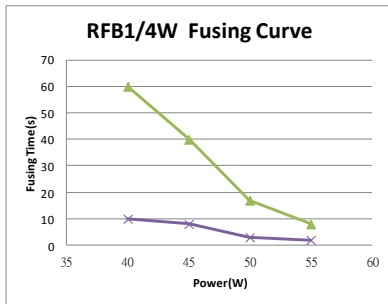

※能量可以依客戶需求製作 Energy can be produced according to customer demand

■ 試驗條件與方法 The testing method and condition.

| 試驗項目<br>Test Items                   | 規格值<br>Performance Requirements           | 試驗方法<br>Test Methods and Standard.(JISC5201-1)   |
|--------------------------------------|---|--|
| 電阻值<br>Resistance                    | 規定的誤差值內<br>Within of specified tolerance  | 測量點從端蓋 10mm<br>Measuring points are distance 10mm from the end cap(4.5)                          |
| 溫度係數<br>T.C.R.                       | 規定值內<br>Within of specified T.C.R.        | 室溫+100°C<br>Room temperature +100°C(4.8)   |
| 短時間過負荷<br>Short time overload        | ±(1%+0.05Ω)                               | 4 倍額定功率，5 秒<br>4 times the rated power for 5 seconds   |
| 負荷壽命<br>Load life                    | ±(5%+0.1Ω)                                | Rated voltage at 70°C for 1,000 hours<br>1.5hr ON / 0.5hr OFF Cycles(4.25.1)                     |
| 耐濕負荷壽命<br>Load life in humidity      | ±(5%+0.1Ω)                                | 10% rate power load<br>40°C, 95% RH for 1,000 hours<br>1.5h ON / 0.5h OFF cycle(4.24)            |
| 耐濕性<br>Moisture resistance           | ±(1%+0.05Ω)                               | 40°C, 95% RH, 240 小時<br>40°C, 95% RH for 240 hours   |
| 溫度循環<br>Temperature cycle            | ±(1%+0.05Ω)                               | 5 cycles for -25°C (30min) : room temp. (30min)<br>~ +85°C (30min) room temp. (30min)(4.19)      |
| 焊錫效果<br>Soldeability                 | 95 % (min) coverage                       | Temp. of solder 245°C ± 5°C<br>duration of immersion 3s±0.5s                                     |
| 焊錫耐熱<br>Resistance to soldering heat | ±(1%+0.05Ω)                               | 260°C ± 5°C for 10 seconds (焊錫槽)<br>350°C ± 10°C for 3.5 seconds (手焊錫)(4.18)                     |
| 絕緣電阻<br>Insulation resistance        | >1,000MΩ                                  | 500V 絕緣測試 1 分鐘<br>500V insulation test 1min.(4.6.1)  |
| 不燃性<br>Flameproof                    | 無燃燒現象<br>No evidence of flaming or arcing | AC voltage of 2,4,8,16,32 times the power<br>rating for 1min. (V ≤ 4 times max. working voltage) |

# WIRE RESISTOR

**RWU** 繞線電阻器  
WIRE WOUND RESISTOR (Standard Type)

**RWS** 小型繞線電阻器  
WIRE WOUND RESISTOR (Small Type)

**RWP** 超小型繞線電阻器  
WIRE WOUND RESISTOR (Super Small Type)

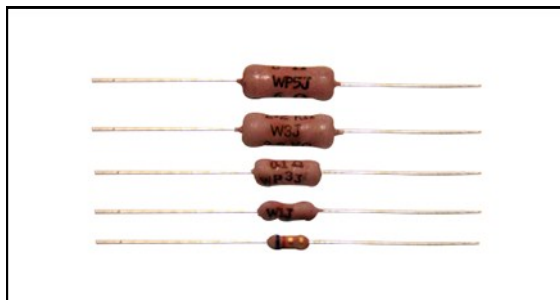

塗料顏色 (Coating Color) :

標準品 (Standard Type) Gray

小型品 (Small Type) Pink

超小型品 (Super Small Type) Pink

標示 (Marking) :

色碼 (Color Code) (RWP1W)

文字 (Alphanumeric) (1/2W~10W)

## 特性 Feature

◎使用不燃性塗料,具不燃與絕緣之安全特性(UL94 V-0)  
Flameproof and insulating coating designed to assure safe usage by special non-flammable silicon-base.  
(Equivalent to UL94 V-0)

◎小型化能高密度插裝

Small size are good for high density application.

◎長期穩定性佳

Stable long service life.

◎產品符合歐盟 RoHS 要求

Products is compliance the EU-RoHS request.

## 產品認證 Approvals awarded

● RWP1W Series UL1412 File No.E257690

## 額定 Ratings

| Rated Power (W) | 阻值範圍 Resistance Range (Ω) |            | 最高使用電壓 Max. Working Voltage | 耐電壓 Dielectric Withstanding Voltage |           | 溫度係數 T.C.R.                                    | 包裝 Taping/Ammo,Forming/Bulk pack (pcs) |      |      |      |      |      |      |      |      |
|-----------------|---------------------------|------------|-----------------------------|-------------------------------------|-----------|--|--|------|------|------|------|------|------|------|------|
|                 | J±5% (E24)                |            |                             |                                     |           |  | A26                                    | A52  | A64  | FT   | YT   | L    | C    | M    | D    |
| P1              | 0.1 ~ 100                 |            | 500V                        | 250V                                | (UL)1000V | ≤ 1Ω :<br>± 500ppm/°C<br>> 1Ω :<br>± 300ppm/°C | 5000                                   | 2500 | -    | -    | -    | -    | -    | -    | -    |
| 1/2,S1,P2       | 0.05 ~ 150                |            |                             | 350V                                | -         |  | -                                      | 2000 | 2000 | 2500 | 2500 | 2500 | 2500 | 2500 | 2500 |
| 1,S2,P3         | 0.05 ~ 330                |            |                             | 350V                                | -         |  | -                                      | 1000 | 1000 | 1000 | 1000 | 1000 | 1000 | 1000 | 1000 |
| 2,S3,P5         | 0.05 ~ 1K                 |            |                             | 500V                                | -         |  | -                                      | 500  | 500  | -    | 1000 | 1000 | 1000 | 1000 | 1000 |
| 3,S5,7          |                           |            |                             | 500V                                | -         |  | -                                      | -    | -    | 500  | 500  | -    | 500  | -    | 500  |
| 7,10            | 0.05 ~ 15K                | 0.05 ~ 27K |                             | 500V                                | -         |  | -                                      | -    | -    | -    | -    | -    | -    | -    | -    |

## 結構圖 Construction

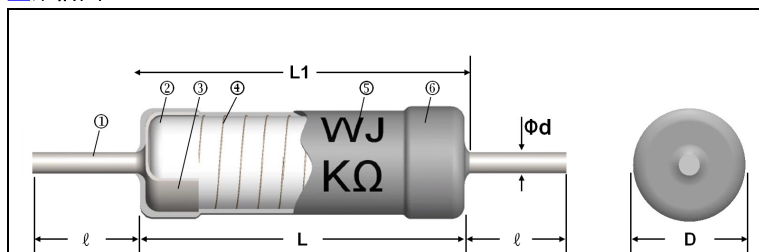

|   |     |              |   |      |                       |
|---|-----|--------------|---|------|-----------------------|
| 1 | 端子線 | Lead wire    | 4 | 繞線   | Wire wound            |
| 2 | 瓷棒  | Ceramic base | 5 | 標示   | Marking or color code |
| 3 | 鐵帽  | Cap          | 6 | 絕緣塗料 | Insulation coat       |

## 外型尺寸 Dimensions

| Rated Power (W) | Dimensions (mm) |         |         |              |      | Weight (g) (1000pcs) |
|-----------------|-----------------|---------|---------|--------------|------|----------------------|
|                 | L               | L1 Max. | D       | Ød           | l    |                      |
| P1              | 6±0.5           | 7       | 2.4±0.1 | 0.6±0.05     | 28±3 | 210                  |
| P1 (UL)         | 9.5±1           | 12      | 4.5±1   | 0.7±0.05     | 28±3 | 510                  |
| 1/2,S1,P2       | 9±0.5           | 11      | 3.3±0.5 | 0.6/0.8±0.05 | 28±3 | 285                  |
| 1,S2,P3         | 12±1            | 15      | 4.5±0.5 | 0.8±0.05     | 38±3 | 728                  |
| 2,S3,P5         | 16±1            | 18      | 5.5±0.5 |              |      | 1380                 |
| 3,S5,7          | 25±1            | 28      | 8.5±0.5 | 0.8±0.05     | 38±3 | 3768                 |
| 10              | 44MAX           | 46MAX   | 8MAX    |              |      | 6200                 |

## 料號編碼 Type composition 例 Example

| RW      | U              | 12               | J             | 1000              | A520            | NH              |
|---------|----------------|------------------|---------------|-------------------|-----------------|-----------------|
| 型名 Type | 品名 Size        | 額定功率 Rated Power | 誤差值 Tolerance | 電阻值(Ω) Resistance | 二次加工 Forming    | 端子線 Lead Wire   |
|         | U: Standard    | 12:1/2W          | F±1%          | R100=0.1          | See table below | 熱鍍線 Heat plated |
|         | S: Small       | 01:1W            | G±2%          | 1R00=1            |                 |                 |
|         | P: Super small | 02:2W            | J±5%          | 10R0=10           |                 |                 |
|         |                | 03:3W            |               | 1000=100          |                 |                 |
|         |                | 05:5W            |               | 1001=1K           |                 |                 |
|         |                | 07:7W            |               | 1002=10K          |                 |                 |

■ 額定溫度下降曲線圖 Derating curve

例 Example

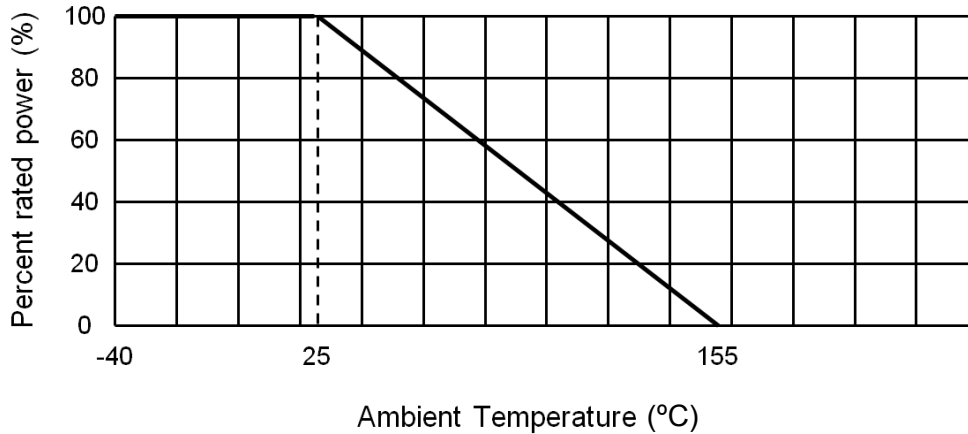

■ 二次加工對應表 Taping & Forming Matrix

| Rated Power (W) | Taping |     |     | Radial Taping |    | L Forming |       |     |     | C Forming |     |     |     | F Forming |     |     |     | M Forming |     |     | D Forming |     |     |     |
|-----------------|--------|-----|-----|---------------|----|-----------|-------|-----|-----|-----------|-----|-----|-----|-----------|-----|-----|-----|-----------|-----|-----|-----------|-----|-----|-----|
|                 | A26    | A52 | A64 | FT            | YT | L10       | L12.5 | L15 | L20 | C12.5     | C15 | C20 | C30 | FA5       | FB5 | FC5 | FD5 | M12.5     | M15 | M20 | D12.5     | D15 | D20 | D30 |
| P1              | ○      | —   | —   | ○             | —  | ○         | —     | —   | —   | —         | —   | —   | —   | ○         | ○   | ○   | ○   | —         | —   | —   | —         | —   | —   | —   |
| 1/2,S1,P2       | —      | ○   | —   | ○             | ○  | —         | ○     | —   | —   | ○         | —   | —   | —   | ○         | ○   | ○   | ○   | ○         | —   | —   | —         | ○   | —   | —   |
| 1,S2,P3         | —      | ○   | —   | ○             | ○  | —         | —     | ○   | —   | —         | ○   | —   | —   | ○         | ○   | ○   | ○   | —         | ○   | —   | —         | ○   | —   | —   |
| 2,S3,P5         | —      | ○   | ○   | —             | ○  | —         | —     | —   | ○   | —         | —   | ○   | —   | ○         | ○   | ○   | ○   | —         | —   | ○   | —         | —   | ○   | —   |
| 3,S5            | —      | —   | —   | —             | —  | —         | —     | —   | —   | —         | —   | ○   | —   | —         | —   | —   | —   | —         | —   | —   | —         | —   | —   | ○   |
| 7,10            | —      | —   | —   | —             | —  | —         | —     | —   | —   | —         | —   | —   | —   | —         | —   | —   | —   | —         | —   | —   | —         | —   | —   | —   |

■ 試驗條件與方法 The testing method and condition.

| 試驗項目<br>Test Items                   | 規格值<br>Performance Requirements           | 試驗方法<br>Test Methods and Standard.(JISC5201-1)   |
|--------------------------------------|---|--|
| 電阻值<br>Resistance                    | 規定的誤差值內<br>Within of specified tolerance  | 測量點從端蓋 10mm<br>Measuring points are distance 10mm from the end cap(4.5)                          |
| 溫度係數<br>T.C.R.                       | 規定值內<br>Within of specified T.C.R.        | 室溫+100°C<br>Room temperature +100°C(4.8)   |
| 短時間過負荷<br>Short time overload        | ±(1%+0.05Ω)                               | 6.25 倍額定功率，5 秒<br>6.25 times the rated power for 5 seconds(4.13)                                 |
| 負荷壽命<br>Load life                    | ±(5%+0.1Ω)                                | Rated voltage at 70°C for 1,000 hours<br>1.5hr ON / 0.5hr OFF Cycles(4.25.1)                     |
| 耐濕負荷壽命<br>Load life in humidity      | ±(5%+0.1Ω)                                | 10% rate power load<br>40°C, 95% RH for 1,000 hours<br>1.5h ON / 0.5h OFF cycle(4.24)            |
| 耐濕性<br>Moisture resistance           | ±(1%+0.05Ω)                               | 40°C, 95% RH, 240 小時<br>40°C, 95% RH for 240 hours   |
| 溫度循環<br>Temperature cycle            | ±(1%+0.05Ω)                               | 5 cycles for -25°C (30min) : room temp. (30min)<br>~ +85°C (30min) room temp. (30min)(4.19)      |
| 焊錫效果<br>Soldeability                 | 95 % (min) coverage                       | Temp. of solder 245°C ± 5°C<br>duration of immersion 3s±0.5s                                     |
| 焊錫耐熱<br>Resistance to soldering heat | ±(1%+0.05Ω)                               | 260°C ± 5°C for 10 seconds (焊錫槽)<br>350°C ± 10°C for 3.5 seconds (手焊錫)(4.18)                     |
| 絕緣電阻<br>Insulation resistance        | >1,000MΩ                                  | 500V 絕緣測試 1 分鐘<br>500V insulation test 1min.(4.6.1)  |
| 不燃性<br>Flameproof                    | 無燃燒現象<br>No evidence of flaming or arcing | AC voltage of 2,4,8,16,32 times the power<br>rating for 1min. (V ≤ 4 times max. working voltage) |

# NON INDUCTIVE RESISTOR

- NWU** 繞線式無感電阻器
- NMU** NON INDUCTIVE RESISTOR (Wirewound standard Type)
- NWS** 小型繞線式無感電阻器
- NMS** NON INDUCTIVE RESISTOR (Small Wirewound Type)
- NWP** 超小型繞線式無感電阻器
- NMP** NON INDUCTIVE RESISTOR (Super Small Wirewound Type)

- NVU** 皮膜無感精密電阻器
- NVU** NON INDUCTIVE PRECISION RESISTOR (Standard Type)
- NVS** 小型皮膜無感精密電阻器
- NVS** NON INDUCTIVE PRECISION RESISTOR (Small Type)
- NVP** 超小型皮膜無感精密電阻器
- NVP** NON INDUCTIVE PRECISION RESISTOR (Super Small Type)



- 塗料顏色 (Coating Color) :
- 標準品 (Standard Type) Gray
- 小型品 (Small Type) Pink
- 超小型品 (Super Small Type) Pink
- 標示 (Marking) :
- 色碼 (Color Code) (S1/2W)
- 文字 (Alphanumeric) (1/2W~7W)

## 特性 Feature

- ◎使用不燃性塗料,具不燃與絕緣之安全特性.(UL94 V-0)  
Flameproof and insulating coating designed to assure safe usage by special non-flammable silicon-base.  
(Equivalent to UL94 V-0)
- ◎小型化能高密度插裝  
Small size are good for high density application.
- ◎超低電感量 (1KHz : 3μH 以下)  
Low inductance value (1KHz : Under 3μH).
- ◎產品符合歐盟 RoHS 要求  
Products is compliance the EU-RoHS request.

## 參考規格 Reference standards

- JIS C 5201-1

## 額定 Ratings

| Rated Power (W) | 阻值範圍 Resistance Range (Ω) |           |           | 最高使用電壓 Max. Working Voltage | 耐電壓 Dielectric Withstanding Voltage | 溫度係數 T.C.R. | 包裝 Taping/Ammo pack (pcs) |      |      |      |    |
|-----------------|---------------------------|-----------|-----------|-----------------------------|-------------------------------------|-------------|---------------------------|------|------|------|----|
|                 | NW (Wire)                 | NM (Film) | NV (Film) |                             |                                     |             | A26                       | A52  | A64  | FT   | YT |
| P1              | 0.1~10                    | 2Ω~ 12M   | 10Ω~ 3G   | 750V                        | NW : 350V<br>NM · NV : 500V         | NW Type     | 5000                      | 2500 | —    | 2000 | —  |
| 1/2,S1,P2       | 0.05 ~ 22                 |           |           | —                           |                                     | 2000        | —                         | 1000 | 1000 |      |    |
| 1,S2,P3         | 0.05 ~ 47                 | —         |           | 1000                        |                                     | 1000        | 1000                      | 1000 |      |      |    |
| 2,S3,P5         | 0.05 ~ 100                | 2Ω~ 14M   |           | —                           |                                     | 500         | 500                       | 1000 | 1000 |      |    |
| 3,S5            | 0.05 ~ 220                | 2Ω~ 1M    | 1500V     | —                           |                                     | —           | —                         | —    | —    |      |    |
| 7               |                           |           | —         | —                           |                                     | —           | —                         | —    |      |      |    |
| 10              | 0.1~1k                    | 10~1M     | 10000V    | —                           | —                                   | —           | —                         | —    |      |      |    |

## 結構圖 Construction

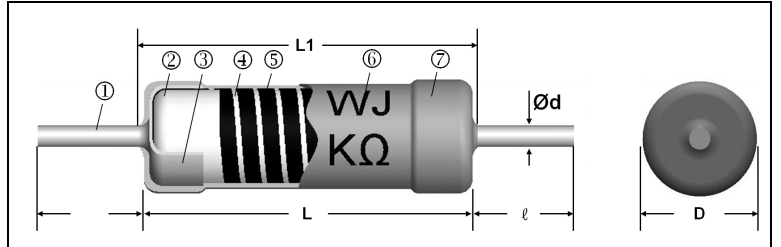

|   |     |                        |   |      |                         |
|---|-----|------------------------|---|------|-------------------------|
| 1 | 端子線 | Lead wire              | 5 | 繞線   | Wire wound/NW           |
| 2 | 瓷棒  | Ceramic base           | 5 | 導電層材 | Conductive film/NM · NV |
| 3 | 鐵帽  | Cap                    | 6 | 標示   | Marking or color code   |
| 4 | 切割線 | Helical cutting groove | 7 | 絕緣塗料 | Insulation coat         |

## 外型尺寸 Dimensions

| Rated Power (W) | Dimensions (mm) |         |         |                    |                              | Weight (g) (1000pcs) |
|-----------------|-----------------|---------|---------|--------------------|------------------------------|----------------------|
|                 | L               | L1 Max. | D       | Ød                 | l                            |                      |
| P1              | 6±0.3           | 7       | 2.4±0.1 | 0.6±0.05<br>P2:0.7 | 28±2                         | 210                  |
| 1/2,S1,P2       | 9±0.5           | 11      | 3.3±0.5 |                    | 28±3                         | 285                  |
| 1,S2,P3         | 12±1            | 15      | 4.5±0.5 | 0.8±0.05           | 38±3<br>(S2W<br>S3W<br>36±3) | 728                  |
| 2,S3,P5         | 16±1            | 18      | 6±1     |                    |                              | 1380                 |
| 3,S5            | 25±1            | 28      | 8.5±0.5 |                    |                              | 3768                 |
| 7               | 25±1            | 28      | 8.5±0.5 |                    |                              | 3768                 |
| 10              | 40±1            | 42      | 8.5±0.5 | 33±1               | 6434                         |                      |

## 料號編碼 Type composition 例 Example

| NW      | U              | 12               | J             | 1000              | A520         | NH              |
|---------|----------------|------------------|---------------|-------------------|--------------|-----------------|
| 型名 Type | 品名 Size        | 額定功率 Rated Power | 誤差值 Tolerance | 電阻值(Ω) Resistance | 二次加工 Forming | 端子線 Lead Wire   |
| NW      | U: Standard    | 12:1/2W          | G±2%          | R100=0.1          | See table    | 熱鍍線 Heat plated |
| NM      | S: Small       | 01:1W            | J±5%          | 1R00=1            | below        | Heat plated     |
| NV      | P: Super small | 02:2W            |               | 10R0=10           |              |                 |
|         |                | 03:3W            |               | 1000=100          |              |                 |
|         |                | 05:5W            |               | 1001=1K           |              |                 |
|         |                | A0:10W           |               | 1002=10K          |              |                 |

■ 額定溫度下降曲線圖 Derating curve

例 Example

**NW Type**

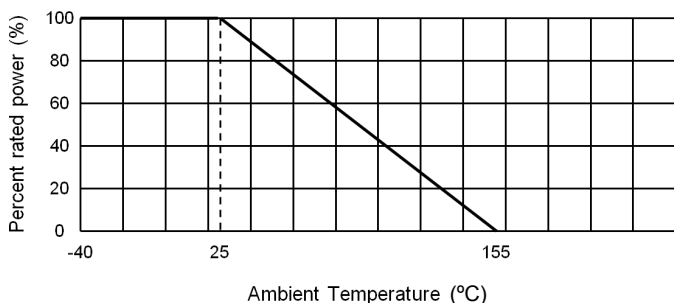

**NV Type**

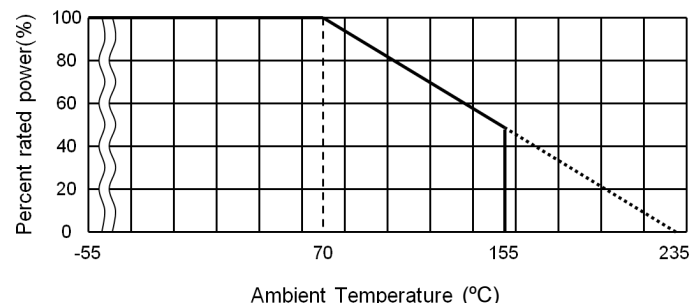

■ 二次加工對應表 Taping & Forming Matrix

| Rated Power (W) | Taping |     |     | Radial Taping |    | L Forming |       |     |     | C Forming |     |     |     | F Forming |     |     |     | M Forming |     |     | D Forming |     |     |     |   |
|-----------------|--------|-----|-----|---------------|----|-----------|-------|-----|-----|-----------|-----|-----|-----|-----------|-----|-----|-----|-----------|-----|-----|-----------|-----|-----|-----|---|
|                 | A26    | A52 | A64 | FT            | YT | L10       | L12.5 | L15 | L20 | C12.5     | C15 | C20 | C30 | FA5       | FB5 | FC5 | FD5 | M12.5     | M15 | M20 | D12.5     | D15 | D20 | D30 |   |
| P1              | ○      | ○   | -   | -             | -  | -         | -     | -   | -   | -         | -   | -   | -   | -         | -   | -   | -   | -         | -   | -   | -         | -   | -   | -   | - |
| 1/2,S1,P2       | -      | ○   | -   | ○             | ○  | -         | ○     | -   | -   | ○         | -   | -   | -   | ○         | ○   | ○   | ○   | ○         | -   | -   | ○         | -   | -   | -   | - |
| 1,S2,P3         | -      | ○   | ○   | ○             | ○  | -         | -     | ○   | -   | -         | ○   | -   | -   | ○         | ○   | ○   | ○   | -         | ○   | -   | -         | ○   | -   | -   | - |
| 2,S3,S5,P5      | -      | ○   | ○   | -             | ○  | -         | -     | -   | ○   | -         | -   | ○   | -   | ○         | ○   | ○   | ○   | -         | -   | ○   | -         | -   | ○   | -   | - |
| 3               | -      | -   | -   | -             | -  | -         | -     | -   | -   | -         | -   | -   | ○   | -         | -   | -   | -   | -         | -   | -   | -         | -   | -   | -   | ○ |
| 7               | -      | -   | -   | -             | -  | -         | -     | -   | -   | -         | -   | -   | -   | -         | -   | -   | -   | -         | -   | -   | -         | -   | -   | -   | - |

■ 試驗條件與方法 The testing method and condition.

| 試驗項目<br>Test Items                   | 規格值<br>Performance Requirements           | 試驗方法<br>Test Methods and Standard.(JISC5201-1)   |
|--------------------------------------|---|--|
| 電阻值<br>Resistance                    | 規定的誤差值內<br>Within of specified tolerance  | 測量點從端蓋 10mm<br>Measuring points are distance 10mm from the end cap(4.5)                          |
| 溫度係數<br>T.C.R.                       | 規定值內<br>Within of specified T.C.R.        | 室溫+100°C<br>Room temperature +100°C(4.8)   |
| 短時間過負荷<br>Short time overload        | ±(1%+0.05Ω)                               | 6.25 倍額定功率，5 秒<br>6.25 times the rated power for 5 seconds(4.13)                                 |
| 負荷壽命<br>Load life                    | ±(5%+0.1Ω)                                | Rated voltage at 70°C for 1,000 hours<br>1.5hr ON / 0.5hr OFF Cycles(4.25.1)                     |
| 耐濕負荷壽命<br>Load life in humidity      | ±(5%+0.1Ω)                                | 10% rate power load<br>40°C, 95% RH for 1,000 hours<br>1.5h ON / 0.5h OFF cycle(4.24)            |
| 耐濕性<br>Moisture resistance           | ±(1%+0.05Ω)                               | 40°C，95% RH，240 小時<br>40°C, 95% RH for 240 hours   |
| 溫度循環<br>Temperature cycle            | ±(1%+0.05Ω)                               | 5 cycles for -25°C (30min) ; room temp.(30min)<br>~ +85°C (30min) room temp. (30min)(4.19)       |
| 焊錫效果<br>Soldeability                 | 95 % (min) coverage                       | Temp. of solder 245°C ± 5°C<br>duration of immersion 3s±0.5s                                     |
| 焊錫耐熱<br>Resistance to soldering heat | ±(1%+0.05Ω)                               | 260°C ± 5°C for 10 seconds (焊錫槽)<br>350°C ± 10°C for 3.5 seconds (手焊錫)(4.18)                     |
| 絕緣電阻<br>Insulation resistance        | >1,000MΩ                                  | 500V 絕緣測試 1 分鐘<br>500V insulation test 1min.(4.6.1)  |
| 不燃性<br>Flameproof                    | 無燃燒現象<br>No evidence of flaming or arcing | AC voltage of 2,4,8,16,32 times the power<br>rating for 1min. (V ≤ 4 times max. working voltage) |

# METAL PLATE CEMENT RESISTOR

**MPC** 金屬板電阻器  
METAL PLATE CEMENT RESISTOR (MPC Type)

**MPH** 金屬板電阻器  
METAL PLATE CEMENT RESISTOR (MPH Type)



Only Available In 4W

本體顏色 (Body color) :

白色 (White)

標示 (Marking) :

Coating color Green

本體顏色 (Body color) :

白色 (White)

塗料顏色 (Coating color)

綠色 (Green)

◎阻值範圍 0.01Ω~25Ω.

Resistance value range 0.01Ω~25Ω.

標示 (Marking) :

文字 (Alphanumeric)

## 特性 Feature

◎不燃與絕緣之安全設計

Compact type with safety design of Non-flammability and Insulation.

◎低阻值耐突波佳

Low resistance and resilient to surge current.

◎無電感

Non- inductance.

◎產品符合歐盟 RoHS 要求

Products is compliance the EU-RoHS request.

## 參考規格 Reference standards

● JIS C 5201-1

## 料號編碼 Type composition

例 Example

| MPC        | 02                  | J                | R010                 | S000            | CP               |
|------------|---------------------|------------------|----------------------|-----------------|------------------|
| 型名<br>Type | 額定功率<br>Rated Power | 誤差值<br>Tolerance | 電阻值(Ω)<br>Resistance | 二次加工<br>Forming | 端子線<br>Lead Wire |
|            | 01:1W               | F±1%             | R010=0.01            | S000 :          | CP Wire          |
|            | 02:2W               | G±2%             | R100=0.1             | Straight        |                  |
|            | 03:3W               | J±5%             | 1R00=1               | F090 :          |                  |
|            | 05:5W               | K±10%            | 10R0=10              | Forming         |                  |
|            | A0:10W              |                  |                      |                 |                  |
| MPH        | 04                  | J                | R100                 | S002            | CP               |
| 型名<br>Type | 額定功率<br>Rated Power | 誤差值<br>Tolerance | 電阻值(Ω)<br>Resistance | 二次加工<br>Forming | 端子線<br>Lead Wire |
|            | 04:4W               | J±5%             | R100=0.1             | S002: 2Pin      | CP Wire          |
|            |                     | K±10%            | 1R00=1               | S004: 4Pin      |                  |

## 額定 Ratings

| TYPE | Rated Power (W) | 阻值範圍 Resistance Range (Ω) |         | 誤差值 Tolerance                 | 耐電壓 Dielectric Withstanding Voltage | 溫度係數 T.C.R.                            | 包裝 Pack (pcs) |         |
|------|-----------------|---------------------------|---------|-------------------------------|-------------------------------------|--|---------------|---------|
|      |                 |                           |         |                               |                                     |  | Straight      | Forming |
| MPC  | 01              | 0.01~0.5                  |         | F±1%<br>G±2%<br>J±5%<br>K±10% | 500V                                | ±100ppm/°C<br>±200ppm/°C<br>±350ppm/°C | 1000          | ---     |
|      | 70              | 0.1~1.0                   |         |                               |                                     |  |               |         |
|      | 76              | 0.01~0.05                 |         |                               |                                     |  |               |         |
|      | 78              | 0.1~1.0                   |         |                               |                                     |  |               |         |
|      | 72              | 0.1~1.0                   |         |                               |                                     |  |               |         |
|      | 73              | 0.006~0.08                |         |                               |                                     |  |               |         |
|      | 71              | 0.1~1.0                   |         |                               |                                     |  |               |         |
|      | 74              | 0.01~1.0                  |         |                               |                                     |  |               |         |
|      | 75              | 0.01~0.08                 | 1.5~2.2 |                               |                                     |  |               |         |
|      | 722             | 0.1~3.3                   |         |                               |                                     |  |               |         |
|      | 708             | 0.1~1.0                   |         |                               |                                     |  |               |         |
|      | 733             | 0.1~1.0                   |         |                               |                                     |  |               |         |
|      | 735             | 0.01~0.08                 |         |                               |                                     |  |               |         |
|      | 725             | 0.1~1.0                   |         |                               |                                     |  |               |         |
| MPH  | 04              | 0.1~33                    |         | K±10%                         |                                     |  | 200           |         |

■結構圖 Construction

|                                  |                       |  |                    |  |                    |
|----------------------------------|-----------------------|--|--------------------|--|--------------------|
| <p><b>MPC &amp; MPH TYPE</b></p> |                       | <p><b>MPC Type</b></p> <p>1W 腳距 P : 5 ±0.5mm</p> |                    | <p><b>MPH Type</b></p> <p>Only Available In 4W</p> |                    |
| 1                                | 端子線<br>Lead wire      | 3  | 金屬板<br>Metal board | 5  | 瓷殼<br>Ceramic case |
| 2                                | 矽水泥<br>Silicon cement | 4  | 標示<br>Marking      |  |                    |

■外型尺寸 Dimensions

| TYPE | 型名 Model   | Dimensions (mm) |         |         |          | Weight (g)<br>(1000pcs) |
|------|------------|-----------------|---------|---------|----------|-------------------------|
|      |            | A               | B       | C       | ∅d       |                         |
| MPC  | 01         | 10±1.0          | 10±1.0  | 5±0.5   | 0.8±0.05 | 1250                    |
|      | 70, 76, 78 | 8.0±1.0         | 13±1.0  | 4±0.5   | 0.6±0.05 | 1250                    |
|      | 72, 73     | 13±1.0          | 13±1.0  | 5±0.5   | 0.6±0.05 | 2350                    |
|      | 71         | 18±1.0          | 14±1.0  | 5±0.5   | 0.6±0.05 | 3400                    |
|      | 74, 75     | 18±1.0          | 14±1.0  | 5±0.5   | 0.8±0.05 | 3400                    |
|      | 722        | 18±1.0          | 26±1.0  | 5±0.5   | 0.8±0.05 | 5900                    |
|      | 708        | 9.0±1.0         | 26±1.0  | 5±0.5   | 0.6±0.05 | 3000                    |
|      | 735        | 13±1.0          | 26±1.0  | 5±0.5   | 0.6±0.05 | 5000                    |
|      | 733        | 13±1.0          | 26±1.0  | 5±0.5   | 0.6±0.05 | 5000                    |
|      | 725        | 18±1.0          | 26±1.0  | 5±0.5   | 0.8±0.05 | 6000                    |
| MPH  | 4          | 21 ±1.0         | 15 ±1.0 | 2.0±0.5 | 0.6±0.05 | 1650                    |

■額定溫度下降曲線圖 Derating curve

例 Example

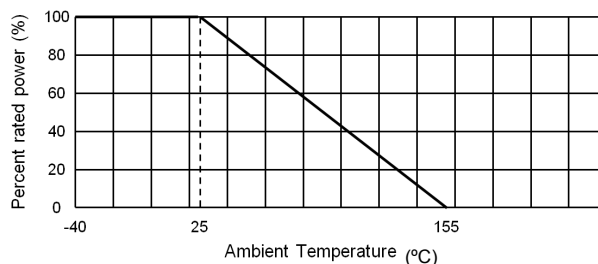

■試驗條件與方法 The testing method and condition.

| 試驗項目<br>Test Items                   | 規格值<br>Performance Requirements          | 試驗方法<br>Test Methods and Standard.(JISC5201-1)  |
|--------------------------------------|--|---|
| 電阻值<br>Resistance                    | 規定的誤差值內<br>Within of specified tolerance | 測量點從端蓋 10mm<br>Measuring points are distance 10mm from the end cap(4.5)                     |
| 溫度係數<br>T.C.R.                       | 規定值內<br>Within of specified T.C.R.       | 室溫+100°C<br>Room temperature +100°C(4.8)  |
| 短時間過負荷<br>Short time overload        | ±(2%+0.05Ω)                              | 6.25 倍額定功率，5 秒<br>6.25 times the rated power for 5 seconds(4.13)                            |
| 負荷壽命<br>Load life                    | ±(5%+0.05Ω)                              | Rated voltage at 70°C for 1,000 hours<br>1.5hr ON / 0.5hr OFF Cycles(4.25.1)                |
| 耐濕負荷壽命<br>Load life in humidity      | ±(5%+0.1Ω)                               | 10% rate power load<br>40°C, 95% RH for 1,000 hours<br>1.5h ON / 0.5h OFF cycle(4.24)       |
| 耐濕性<br>Moisture resistance           | ±(2%+0.05Ω)                              | 40°C · 95% RH · 240 小時<br>40°C, 95% RH for 240 hours  |
| 溫度循環<br>Temperature cycle            | ±(1%+0.05Ω)                              | 5 cycles for -25°C (30min) : room temp. (30min)<br>~ +85°C (30min) room temp. (30min)(4.19) |
| 焊錫耐熱<br>Resistance to soldering heat | ±(2%+0.05Ω)                              | 260°C ± 5°C for 10 seconds (焊錫槽)<br>350°C ± 10°C for 3.5 seconds (手焊錫)(4.18)                |
| 絕緣電阻<br>Insulation resistance        | MPH : >10MΩ<br>MPC : >1000MΩ             | 500V 絕緣測試 1 分鐘<br>500V insulation test 1min.(4.6.1)   |

# METAL PLATE CEMENT RESISTOR

MPM

金屬板電阻器

METAL PLATE CEMENT RESISTOR (MPM Type)

## MPM TYPE

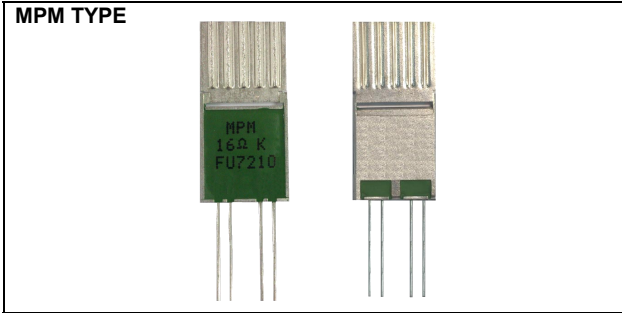

本體顏色 (Body color)

綠色 (Green)

白色 (White)

標示 (Marking)

塗料顏色 (Coating color)

文字 (Alphanumeric)

## 特性 Feature

◎不燃與絕緣之安全設計

Compact type with safety design of Non-flammability and insulation.

◎低阻值耐突波佳及可用於電流偵測

Low resistance and resilient to surge current ,and current sensor application .

◎無電感

Non- inductance.

◎產品符合歐盟 RoHS 要求

Products is compliance the EU-RoHS request.

## 測試標準 Test Standard

1. JIS C 5201-1

2. R.C loop for Surge test.

## 結構圖 Construction

### MPM 4W

### MPM 7W

|   |     |               |   |      |                 |
|---|-----|---------------|---|------|-----------------|
| 1 | 端子線 | Lead wire     | 5 | 金屬板  | Metal board     |
| 2 | 金屬殼 | Metal shell   | 6 | 捺印   | Marking         |
| 3 | 電鍍層 | Plating layer | 7 | 絕緣塗料 | Insulation coat |
| 4 | 陶瓷板 | Ceramic base  |   |      |                 |

## 外形尺寸 Dimensions

| 型名<br>Model | Dimensions (mm) |        |         |      |           |         |         |
|-------------|-----------------|--------|---------|------|-----------|---------|---------|
|             | A               | B      | C       | h    | Ød        | P1      | P2      |
| MPM 4W      | 18±0.5          | 15±1.0 | 2.0±0.5 | 15±3 | 0.60±0.05 | 5.5±0.5 | 9.5±0.5 |
| MPM 5W      | 18±0.5          | 15±1.0 | 2.0±0.5 | 15±3 | 0.60±0.05 | 5.5±0.5 | 9.5±0.5 |
| MPM 7W      | 32±1.0          | 15±1.0 | 3(MAX)  | 16±3 | 0.60±0.05 | 5.0±0.5 | 9.5±0.5 |

Ød=0.5±0.05 (36Ω~100MΩ)

Ød=0.8±0.05 for current sensor application

## 料號編碼 Type composition

例 Example

| MPM        | 04                  | K                | R010                 | S002            | CP               |
|------------|---------------------|------------------|----------------------|-----------------|------------------|
| 型名<br>Type | 額定功率<br>Rated Power | 誤差值<br>Tolerance | 電阻值(Ω)<br>Resistance | 二次加工<br>Forming | 端子線<br>Lead Wire |
|            | 04:4W               | F±1%             | R010=0.01            | S002 :          | CP Wire          |
|            | 05:5W               | J±5%             | R100=0.1             | 2Pin            |                  |
|            | 07:7W               | K±10%            | 1R00=1<br>10R0=10    | S004 :<br>4Pin  |                  |

## 額定 Ratings

| TYPE | Rated Power (W) | 阻值範圍 Resistance Range(Ω) | 誤差值 Tolerance         | 耐電壓 Dielectric Withstanding Voltage | 溫度係數 T.C.R.  | 包裝 Pack (pcs) |         |
|------|-----------------|--------------------------|-----------------------|-------------------------------------|--|---------------|---------|
|      |                 |                          |                       |                                     |  | Straight      | Forming |
| MPM  | 4               | 0.01~100M                | F±1%<br>J±5%<br>K±10% | 500V                                | Normal Type<br>± 350ppm/°C<br>CSR<br>± 100ppm/°C<br>± 50ppm/°C<br>± 25ppm/°C | 1200          | ---     |
|      | 5               | 0.01~100M                |                       |                                     |  |               |         |
|      | 7               | 0.005~100M               |                       |                                     |  |               |         |



■ 額定溫度下降曲線圖 Derating curve

例 Example

4W

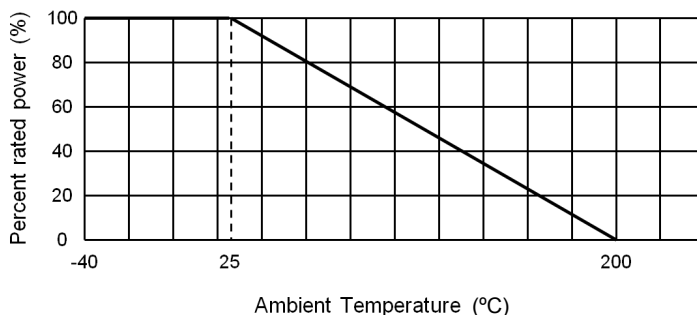

5W

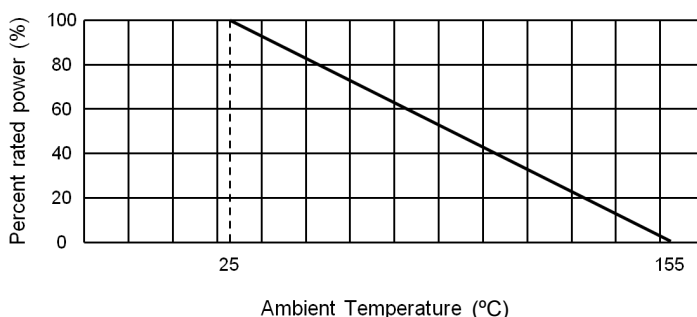

7W

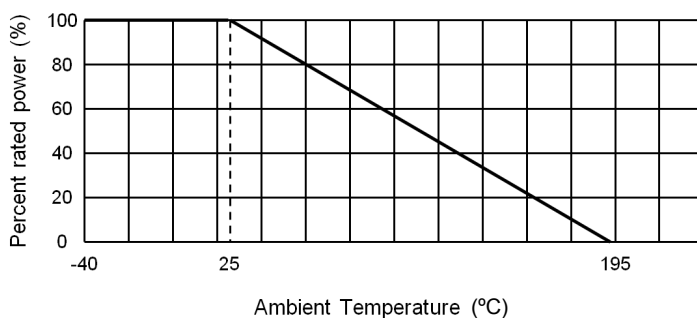

■ 試驗條件與方法 The testing method and condition.

| 試驗項目<br>Test Items                   | 規格值<br>Performance Requirements          | 試驗方法<br>Test Methods and Standard.(JISC5201-1)  |
|--------------------------------------|--|---|
| 電阻值<br>Resistance                    | 規定的誤差值內<br>Within of specified tolerance | 測量點從端蓋 10mm<br>Measuring points are distance 10mm from the end cap(4.5)                     |
| 溫度係數<br>T.C.R.                       | 規定值內<br>Within of specified T.C.R.       | 室溫+100°C<br>Room temperature +100°C(4.8)  |
| 短時間過負荷<br>Short time overload        | ±(2%+0.1Ω)                               | 6.25 倍額定功率 · 5 秒<br>6.25 times the rated power for 5 seconds(4.13)                          |
| 負荷壽命<br>Load life                    | ±(5%+0.1Ω)                               | Rated voltage at 70°C for 1,000 hours<br>1.5hr ON / 0.5hr OFF Cycles(4.25.1)                |
| 耐濕負荷壽命<br>Load life in humidity      | ±(5%+0.1Ω)                               | 10% rate power load<br>40°C, 95% RH for 1,000 hours<br>1.5h ON / 0.5h OFF cycle(4.24)       |
| 耐濕性<br>Moisture resistance           | ±(2%+0.05Ω)                              | 40°C · 95% RH · 240 小時<br>40°C, 95% RH for 240 hours  |
| 溫度循環<br>Temperature cycle            | ±(1%+0.05Ω)                              | 5 cycles for -25°C (30min) : room temp. (30min)<br>~ +85°C (30min) room temp. (30min)(4.19) |
| 焊錫耐熱<br>Resistance to soldering heat | ±(1%+0.05Ω)                              | 260°C ± 5°C for 10 seconds (焊錫槽)<br>350°C ± 10°C for 3.5 seconds (手焊錫)(4.18)                |
| 絕緣電阻<br>Insulation resistance        | >10MΩ                                    | 500V 絕緣測試 1 分鐘<br>500V insulation test 1min.(4.6.1)   |

# METAL PLATE CEMENT RESISTOR

**MPT** 金屬板電阻器  
METAL PLATE CEMENT RESISTOR (MPT Type)

**MPQ** 金屬板電阻器  
METAL PLATE CEMENT RESISTOR (MPQ Type)

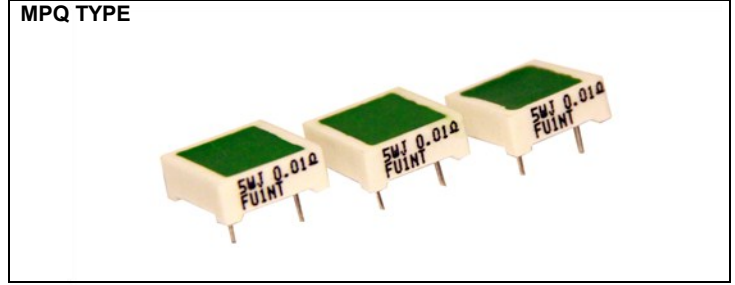
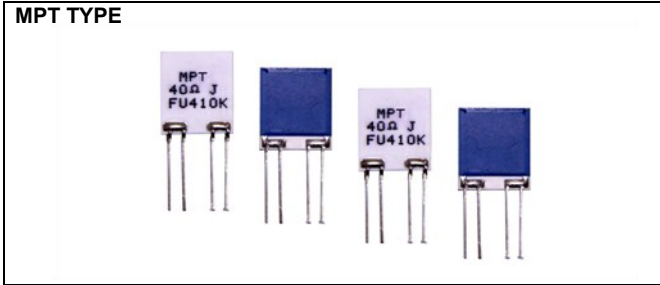

本體顏色 (Body color) :  
白 色 (White)  
塗料顏色 (Coating color) :  
藍 色 (Blue)  
標 示 (Marking) :  
文 字 (Alphanumeric)

本體顏色 (Body color) :  
白 色 (White)  
塗料顏色 (Coating color) :  
綠 色 (Green)  
標 示 (Marking) :  
文 字 (Alphanumeric)

## 特性 Feature

- ◎不燃與絕緣之安全設計  
Compact type with safety design of Non-flammability and insulation.
- ◎低阻值耐突波佳  
Low resistance and resilient to surge current.
- ◎無電感  
Non- inductance.
- ◎產品符合歐盟 RoHS 要求  
Products is compliance the EU-RoHS request.
- ◎可依客戶需求製作  
Can be produced according to customer's request.

## 外形尺寸 Dimensions

| 型名<br>Model | Dimensions mm |         |         |         |          | Weight (g)<br>(1000pcs) |
|-------------|---------------|---------|---------|---------|----------|-------------------------|
|             | A             | B       | C       | h       | Ød       |                         |
| MPT 03      | 15 ±1.0       | 13 ±1.0 | 0.7±0.1 | 15±3.0  | 0.5±0.05 | 630                     |
| MPQ 05      | 16 ±1.0       | 16 ±1.0 | 6.0±0.5 | 4.5±0.5 | 0.8±0.05 | 3110                    |

## 料號編碼 Type composition

例 Example

| MPQ        | 05                  | J                | R010                 | S00             | CP               |
|------------|---------------------|------------------|----------------------|-----------------|------------------|
| 型名<br>Type | 額定功率<br>Rated Power | 誤差值<br>Tolerance | 電阻值(Ω)<br>Resistance | 二次加工<br>Forming | 端子線<br>Lead Wire |
| MPT        | 03:3W               | F±1%             | R010=0.01            | S000 :          | 銅線               |
| MPQ        | 05:5W               | G±2%             | R100=0.1             | Straight        | CP Wire          |
|            |                     | J±5%             | 50R0=50              |                 |                  |
|            |                     | K±10%            | 1000=100             |                 |                  |
|            |                     |                  | 1001=1K              |                 |                  |
|            |                     |                  | 1002=10K             |                 |                  |

## 額定 Ratings

| 型名 Model | Rated Power (W) | 阻值範圍 Resistance Range(Ω) | 耐電壓 Dielectric Withstanding Voltage | 溫度係數 T.C.R. | 包裝 Plate / Bulk pack(pcs) |
|----------|-----------------|--------------------------|-------------------------------------|-------------|---------------------------|
|          |                 | J±5%、K±10%(E24)          |                                     |             |                           |
| MPT 03   | 3               | 36~100M                  | 500V                                | ±350ppm/°C  | 200                       |
| MPQ 05   | 5               | 0.01~0.5                 |                                     |             |                           |

■ 結構圖 Construction

|                     |     |                       |   |     |              |   |     |              |
|---------------------|-----|-----------------------|---|-----|--------------|---|-----|--------------|
| <b>MPT Type</b><br> |     | <b>MPQ Type</b><br>   |   |     |              |   |     |              |
| 1                   | 端子線 | Lead wire             | 3 | 標示  | Marking      | 4 | 金屬板 | Metal board  |
| 2                   | 導電層 | Print impedance layer | 4 | 陶瓷板 | Ceramic base | 5 | 瓷殼  | Ceramic case |

■ 額定溫度下降曲線圖 Derating curve

MPT Type



MPQ Type



■ 試驗條件與方法 The testing method and condition.

| 試驗項目<br>Test Items                            | 規格值<br>Performance Requirements           | 試驗方法<br>Test Methods and Standard.(JISC5201-1)  |
|---|---|---|
| 電阻值<br>Resistance                             | 規定的誤差值內<br>Within of specified tolerance  | 測量點從端蓋 10mm<br>Measuring points are distance 10mm from the end cap(4.5)   |
| 溫度係數<br>T.C.R.                                | 規定值內<br>Within of specified T.C.R.        | 室溫+100°C<br>Room temperature +100°C(4.8)  |
| 短時間過負荷<br>Short time overload                 | ±(2%+0.05Ω)                               | 6.25 倍額定功率，5 秒<br>6.25 times the rated power for 5 seconds(4.13)  |
| 負荷壽命<br>Load life                             | ±(5%+0.1Ω)                                | Rated voltage at 70°C for 1,000 hours<br>1.5hr ON / 0.5hr OFF Cycles(4.25.1)  |
| 耐濕負荷壽命<br>Load life in humidity               | ±(5%+0.1Ω)                                | 10% rate power load<br>40°C, 95% RH for 1,000 hours<br>1.5h ON / 0.5h OFF cycle(4.24)   |
| 耐濕性<br>Moisture resistance                    | ±(2%+0.05Ω)                               | 40°C，95% RH，240 小時<br>40°C, 95% RH for 240 hours  |
| 溫度循環<br>Temperature cycle                     | ±(1%+0.05Ω)                               | 5 cycles for -25°C (30min) : room temp. (30min)<br>~ +85°C (30min) room temp. (30min)(4.19)   |
| 焊錫耐熱<br>Resistance to soldering heat          | ±(2%+0.05Ω)                               | 260°C ± 5°C for 10 seconds (焊錫槽)<br>350°C ± 10°C for 3.5 seconds (手焊錫)(4.18)  |
| 絕緣電阻<br>Insulation resistance                 | >10MΩ                                     | 500V 絕緣測試 1 分鐘<br>500V insulation test 1min.(4.6.1)   |
| 不燃性<br>Flameproof                             | 無燃燒現象<br>No evidence of flaming or arcing | AC voltage of 2,4,8,16,32 times the power<br>rating for 1min. (V ≤ 4 times max. working voltage)  |
| 脈衝測試 (MPT Type)<br>Pulse withstanding voltage | ±20%<br>                                  | The following discharge cycle is repeated<br>in the circuit of the left<br>2.5 sec. ON 2.5 sec. OFF 10,000 cycles.<br>With following DC pulse test voltage.<br>Pulse voltage: 10 KV |

# CEMENT RESISTOR

**RGW** 水泥電阻器  
CEMENT RESISTOR (Wire Type)

**RGF** 水泥電阻器  
CEMENT RESISTOR (film Type)

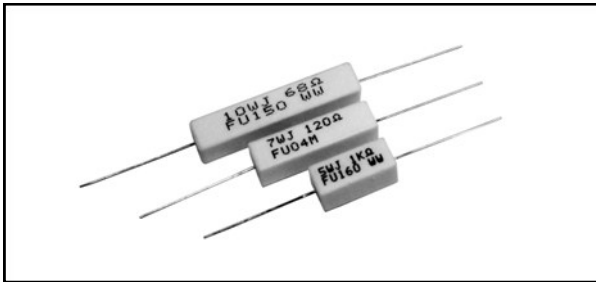

本體顏色 (Body color) :

白色 (White)

標示 (Marking) :

文字 (Alphanumeric)

## 特性 Feature

◎不燃與絕緣之安全設計

Compact type with safety design of non-flammability and insulation.

◎可提供低電感

Low inductance is available.

◎長期穩定性佳

Stable long life.

◎可依客戶需求製作

Can be produced according to customer's request.

◎產品符合歐盟 RoHS 要求

Products is compliance the EU-RoHS request.

## 參考規格 Reference standards

● JIS C 5201-1

## 額定 Ratings

| Rated Power (W) | 阻值範圍 Resistance Range(Ω) |                     | 最高使用電壓 Max. Working Voltage | 最高過負荷電壓 Max. Overload Voltage | 耐電壓 Dielectric Withstanding Voltage | 溫度係數 T.C.R.                              |
|-----------------|--------------------------|---------------------|-----------------------------|-------------------------------|-------------------------------------|--|
|                 | 皮膜型 Film Type            | 繞線型 Wire wound Type |                             |                               |                                     |  |
| 1               | 4~39K                    | 0.1~330             | 150V                        | 500V                          | 1000V                               | ≤ 1Ω: ± 600 ppm/°C<br>> 1Ω: ± 350 ppm/°C |
| 2               | 4~39K                    | 0.1~330             | 150V                        | 750V                          |                                     |  |
| 3               | 4~39K                    | 0.1~330             | 350V                        | 1000V                         |                                     |  |
| 5               | 4~50K                    | 0.1~1K              | 350V                        | 1000V                         |                                     |  |
| 7               | 4~100K                   | 0.1~2.2K            | 500V                        | 1500V                         |                                     |  |
| 10              | 4~100K                   | 0.1~4.7K            | 750V                        | 1500V                         |                                     |  |
| 15              | 4~100K                   | 1~5.1K              | 1000V                       | 1500V                         |                                     |  |
| 20              | 4~100K                   | 1~10K               | 1000V                       | 1500V                         |                                     |  |
| 25              | 4~100K                   | 1~10K               | 1000V                       | 1500V                         |                                     |  |
| 30              | 4~100K                   | 1~10K               | 1000V                       | 1500V                         |                                     |  |
| 40              | 4~100K                   | 1~10K               | 1000V                       | 1500V                         |                                     |  |

## 結構圖 Construction

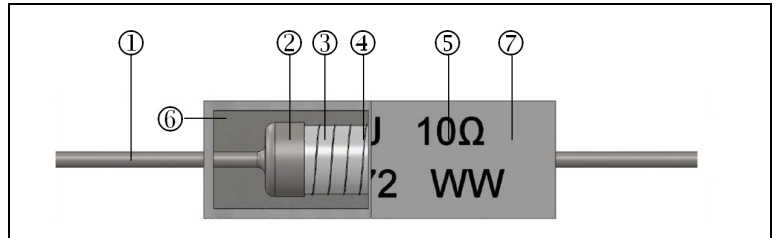

|   |       |                   |   |      |                 |
|---|-------|-------------------|---|------|-----------------|
| 1 | 端子線   | Lead wire         | 5 | 標示   | Marking         |
| 2 | 鐵帽    | Cap               |   |      |                 |
| 3 | 瓷棒    | Ceramic base      | 6 | 絕緣塗料 | Insulation coat |
| 4 | 繞線/皮膜 | Wire wound / Film | 7 | 瓷殼   | Ceramic case    |

## 料號編碼 Type composition 例 Example

| RG      | W       | 01               | J             | R100              | PG00         | NH            |
|---------|---------|------------------|---------------|-------------------|--------------|---------------|
| 型名 Type | 品名 Size | 額定功率 Rated Power | 誤差值 Tolerance | 電阻值(Ω) Resistance | 二次加工 Forming | 端子線 Lead Wire |
|         | W: Wire | 01:1W            | F±1%          | R100=0.1          | PG00=P Type  | NH=Heat       |
|         | F: Film | 02:2W            | G±2%          | 1R00=1            | MG00=M Type  | Plated        |
|         |         | 05:5W            | J±5%          | 10R0=10           | SG00=S Type  | NL=Electro    |
|         |         | 07:7W            | K±10%         | 1000=100          | TG00=T Type  | Plated        |
|         |         | A0:10W           |               | 1001=1K           | HG02=H Type  |               |
|         |         | B5:25W           |               | 1002=10K          |              |               |

## 造型對應表 Type matrix

| RG Type | 額定功率 (W) Rated Power(W) |   |   |   |   |    |    |    |    |    |    |
|---------|-------------------------|---|---|---|---|----|----|----|----|----|----|
|         | 1                       | 2 | 3 | 5 | 7 | 10 | 15 | 20 | 25 | 30 | 40 |
| P       | ◎                       | ◎ | ◎ | ◎ | ◎ | ◎  | ◎  | ◎  | ◎  |    |    |
| Z       |                         |   | ◎ | ◎ | ◎ | ◎  | ◎  | ◎  | ◎  |    |    |
| M       |                         | ◎ | ◎ | ◎ | ◎ | ◎  |    |    |    |    |    |
| T       |                         |   |   | ◎ | ◎ | ◎  |    |    |    |    |    |
| S       |                         |   |   |   | ◎ | ◎  |    |    |    |    |    |
| H       |                         |   |   |   |   | ◎  | ◎  | ◎  |    | ◎  | ◎  |

RGK TYPE Available : 4W 5W 6W 7W 9W 11W 17W

■ 額定溫度下降曲線圖 Derating curve 例 Example

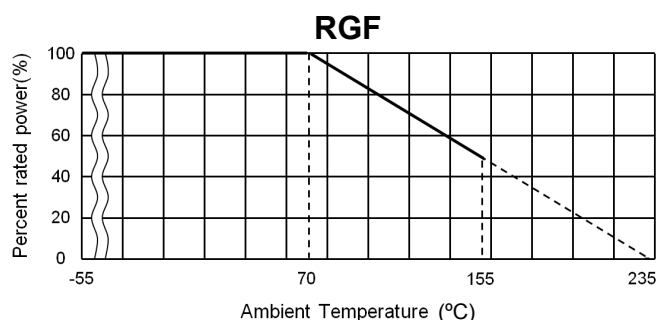

■ 造型圖 (Dimensions see as APPENDIX)

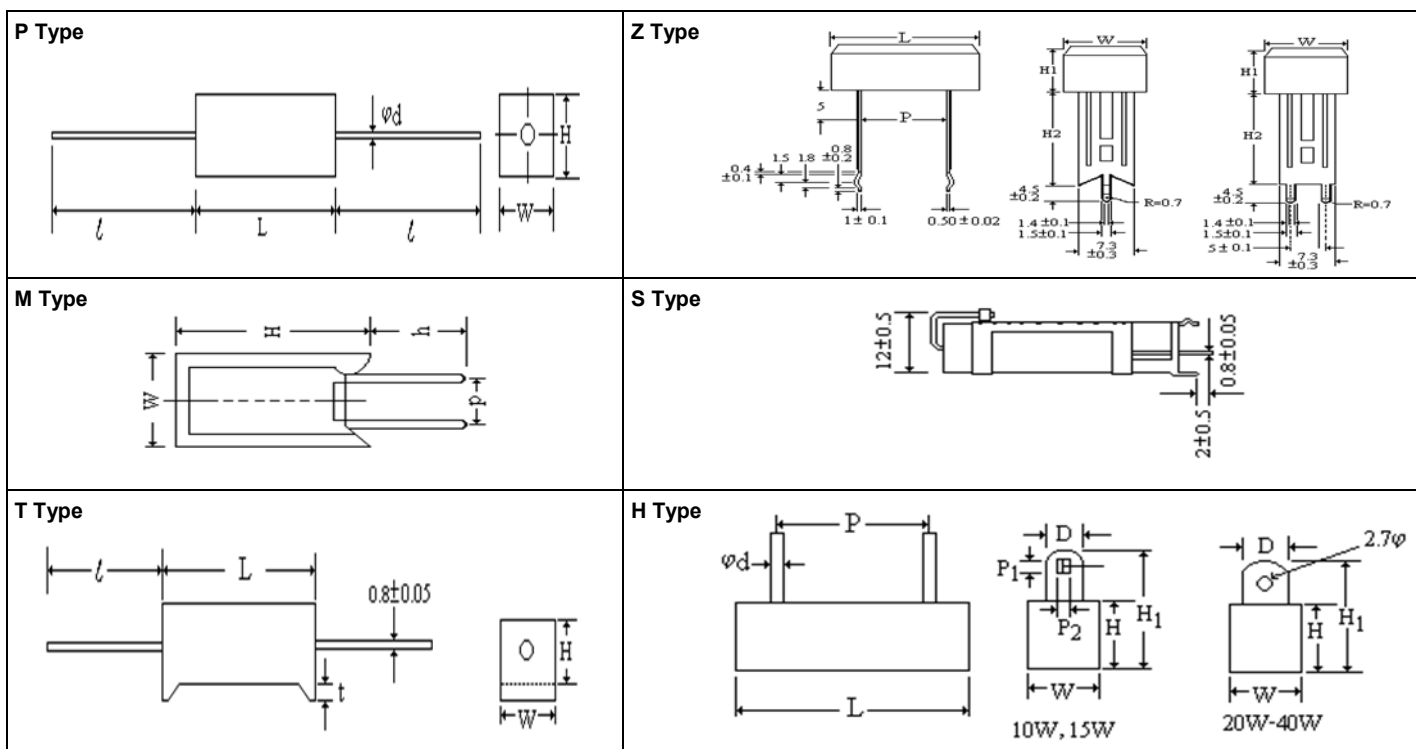

■ 試驗條件與方法 The testing method and condition.

| 試驗項目<br>Test Items                   | 規格值<br>Performance Requirements          | 試驗方法<br>Test Methods and Standard.(JISC5201-1)  |
|--------------------------------------|--|---|
| 電阻值<br>Resistance                    | 規定的誤差值內<br>Within of specified tolerance | 測量點從端蓋 10mm<br>Measuring points are distance 10mm from the end cap(4.5)                     |
| 溫度係數<br>T.C.R.                       | 規定值內<br>Within of specified T.C.R.       | 室溫+100°C<br>Room temperature +100°C(4.8)  |
| 短時間過負荷<br>Short time overload        | ±(1%+0.05Ω)                              | 10 倍額定功率 · 5 秒<br>10 times the rated power for 5 seconds                                    |
| 負荷壽命<br>Load life                    | ±(5%+0.1Ω)                               | Rated voltage at 70□ for 1,000 hours<br>1.5hr ON / 0.5hr OFF Cycles(4.25.1)                 |
| 耐濕負荷壽命<br>Load life in humidity      | ±(5%+0.1Ω)                               | 10% rate power load<br>40°C, 95% RH for 1,000 hours<br>1.5h ON / 0.5h OFF cycle(4.24)       |
| 溫度循環<br>Temperature cycle            | ±(1%+0.05Ω)                              | 5 cycles for -25°C (30min) : room temp. (30min)<br>~ +85°C (30min) room temp. (30min)(4.19) |
| 焊錫耐熱<br>Resistance to soldering heat | ±(1%+0.05Ω)                              | 260°C ± 5°C for 10 seconds (焊錫槽)<br>350°C ± 10°C for 3.5 seconds (手焊錫)(4.18)                |
| 絕緣電阻<br>Insulation resistance        | >1000MΩ                                  | 500V 絕緣測試 1 分鐘<br>500V insulation test 1min.(4.6.1)   |

# CEMENT RESISTOR

RGK

水泥電阻器  
CEMENT RESISTOR (RGK Type)



本體顏色 (Body color) :

白色 (White)

標示 (Marking) :

文字 (Alphanumeric)

## 特性 Feature

◎不燃與絕緣之安全設計

Compact type with safety design of non-flammability and insulation.

◎可提供低電感

Low inductance is available.

◎長期穩定性佳

Stable long life.

◎可依客戶需求製作

Can be produced according to customer's request.

◎產品符合歐盟 RoHS 要求

Products is compliance the EU-RoHS request.

## 參考規格 Reference standards

● JIS C 5201-1

## 額定 Ratings

| Rated Power (W) | 阻值範圍 Resistance Range(Ω) | 溫度係數 T.C.R. | 誤差值 Tolerance                 | 最高使用電壓 Max. Working Voltage | 最高過負荷電壓 Max. Overload Voltage | 耐電壓 Dielectric Withstanding Voltage |
|-----------------|--------------------------|-------------|-------------------------------|-----------------------------|-------------------------------|-------------------------------------|
| 4               | 0.01Ω~ 9.1K              | ± 350ppm/°C | F±1%<br>G±2%<br>J±5%<br>K±10% | 1000V                       | 2000V                         | 2000V                               |
| 5               | 0.022Ω~ 15K              |             |                               |                             |                               |                                     |
| 6               | 0.022Ω~ 15K              |             |                               |                             |                               |                                     |
| 7               | 0.05Ω~ 30K               |             |                               |                             |                               |                                     |
| 9               | 0.05Ω~ 33K               |             |                               |                             |                               |                                     |
| 11              | 0.1Ω~ 47K                |             |                               |                             |                               |                                     |
| 17              | 0.20Ω~ 82K               |             |                               |                             |                               |                                     |

## 結構圖 Construction

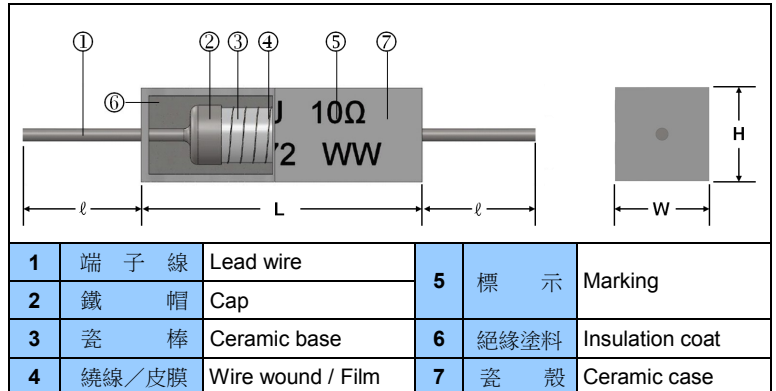

## 外型尺寸 Dimensions

| Rated Power (W) | W (mm)  | H (mm)  | ℓ (mm) | L (mm) |
|-----------------|---------|---------|--------|--------|
| 4               | 6.8±0.3 | 6.8±0.3 | 33±3   | 25±1   |
| 5               | 6.8±0.3 | 6.8±0.3 |        | 25±1   |
| 6               | 6.8±0.3 | 6.8±0.3 |        | 25±1   |
| 7               | 6.8±0.3 | 6.8±0.3 |        | 33±1   |
| 9               | 9.5±0.5 | 9.5±0.5 |        | 33±1   |
| 11              | 9.0±0.3 | 9.0±0.3 |        | 50±1   |
| 17              | 9.5±0.5 | 9.0±0.3 |        | 75±1   |

## 料號編碼 Type composition

例 Example

| RGK     | 05               | J             | R100                                       | S000            | NH            |
|---------|------------------|---------------|--|-----------------|---------------|
| 型名 Type | 額定功率 Rated Power | 誤差值 Tolerance | 電阻值(Ω) Resistance                          | 二次加工 Forming    | 端子線 Lead Wire |
|         | 04:4W            | F±1%          | R010=0.01                                  | See table below | 熱鍍線           |
|         | 05:5W            | G±2%          | R100=0.1                                   |                 | Heat plated   |
|         | 07:7W            | J±5%          | 1R00=1                                     |                 |               |
|         | A0:10W           | K±10%         | 10R0=10<br>1000=100<br>1001=1K<br>1002=10K |                 |               |

■ 額定溫度下降曲線圖 Derating curve

例 Example

4W~7W

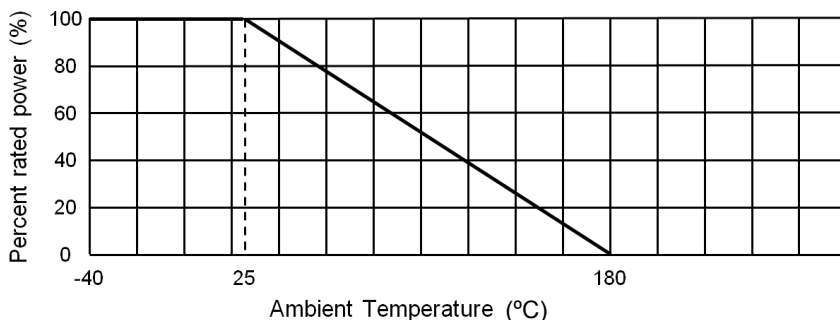

9W~11W



>15W

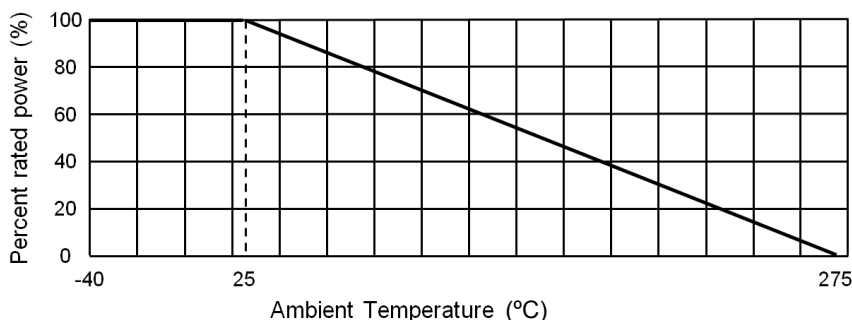

■ 試驗條件與方法 The testing method and condition.

| 試驗項目<br>Test Items                   | 規格值<br>Performance Requirements          | 試驗方法<br>Test Methods and Standard.(JISC5201-1)   |
|--------------------------------------|--|--|
| 電阻值<br>Resistance                    | 規定的誤差值內<br>Within of specified tolerance | 測量點從端蓋 10mm<br>Measuring points are distance 10mm from the end cap(4.5)                    |
| 溫度係數<br>T.C.R.                       | 規定值內<br>Within of specified T.C.R.       | 室溫+100°C<br>Room temperature +100°C(4.8)   |
| 短時間過負荷<br>Short time overload        | ±(1%+0.05Ω)                              | 6.25 倍額定功率，5 秒<br>6.25 times the rated power for 5 seconds(4.13)                           |
| 負荷壽命<br>Load life                    | ±(5%+0.1Ω)                               | Rated voltage at 70°C for 1,000 hours<br>1.5hr ON / 0.5hr OFF Cycles(4.25.1)               |
| 耐濕負荷壽命<br>Load life in humidity      | ±(5%+0.1Ω)                               | 10% rate power load<br>40°C, 95% RH for 1,000 hours<br>1.5h ON / 0.5h OFF cycle(4.24)      |
| 溫度循環<br>Temperature cycle            | ±(1%+0.05Ω)                              | 5 cycles for -25°C (30min) : room temp.(30min)<br>~ +85°C (30min) room temp. (30min)(4.19) |
| 焊錫耐熱<br>Resistance to soldering heat | ±(1%+0.05Ω)                              | 260°C ± 5°C for 10 seconds (焊錫槽)<br>350°C ± 10°C for 3.5 seconds (手焊錫)                     |
| 絕緣電阻<br>Insulation resistance        | >1000MΩ                                  | 500V 絕緣測試 1 分鐘<br>500V insulation test 1min.(4.6.1)  |

# CURRENT SENSOR RESISTOR

RGC

電流偵測電阻器  
CURRENT SENSOR RESISTOR (RGC Type)

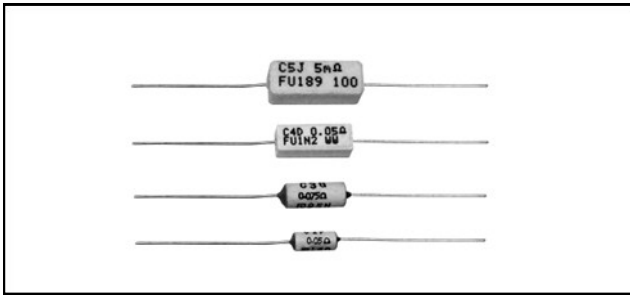

本體顏色 (Body color) :  
白色 (White)  
標示 (Marking) :  
文字 (Alphanumeric)

## 特性 Feature

- ◎不燃與絕緣之安全設計  
Compact type with safety design of non-flammability and insulation.
- ◎可提供低電感  
Low inductance is available.
- ◎長期穩定性佳  
Stable long life.
- ◎可依客戶需求製作  
Can be produced according to customer's request.
- ◎產品符合歐盟 RoHS 要求  
Products is compliance the EU-RoHS request.

## 參考規格 Reference standards

- JIS C 5201-1

## 額定 Ratings

| Rated Power (W) | 阻值範圍 Resistance Range(Ω)     | 溫度係數 T.C.R.                          | 誤差值 Tolerance                 | 最高使用電壓 Max. Working Voltage | 最高過負荷電壓 Max. Overload Voltage | 耐電壓 Dielectric Withstanding Voltage |
|-----------------|------------------------------|--------------------------------------|-------------------------------|-----------------------------|-------------------------------|-------------------------------------|
| 1               | 0.001Ω~ 0.1Ω<br>(1mΩ~ 100mΩ) | ±20ppm/°C<br>±50ppm/°C<br>±100ppm/°C | F±1%<br>G±2%<br>J±5%<br>K±10% | $\sqrt{PR}$                 | $\sqrt{10PR}$                 | 2000V                               |
| 2               |                              |                                      |                               |                             |                               |                                     |
| 3               |                              |                                      |                               |                             |                               |                                     |
| 4               |                              |                                      |                               |                             |                               |                                     |
| 5               |                              |                                      |                               |                             |                               |                                     |
| 7               |                              |                                      |                               |                             |                               |                                     |
| 9               |                              |                                      |                               |                             |                               |                                     |
| 10              |                              |                                      |                               |                             |                               |                                     |
| 20              |                              |                                      |                               |                             |                               |                                     |

## 結構圖 Construction

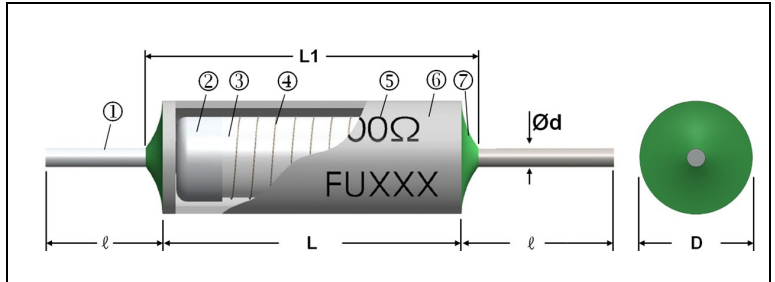

|   |     |              |   |         |                             |
|---|-----|--------------|---|---------|-----------------------------|
| 1 | 端子線 | Lead wire    | 5 | 標示      | Marking                     |
| 2 | 瓷棒  | Ceramic base | 6 | 絕緣塗料    | Insulation coat             |
| 3 | 鐵帽  | Cap          | 7 | 瓷管 / 瓷殼 | Ceramic tube / Ceramic case |
| 4 | 繞線  | Wire wound   |   |         |                             |

## 外型尺寸 Dimensions

| Rated Power (W) | L (mm) | L1 Maxd (mm) | D (mm) | ℓ (mm) | Ød (mm)  |
|-----------------|--------|--------------|--------|--------|----------|
| 1               | 11.5±1 | 15           | 4.3±1  | 26±2   | 0.6±0.05 |
| 2               | 11.5±1 | 15           | 4.3±1  | 26±2   | 0.6±0.05 |
| 3               | 15±1   | 19           | 5.5±1  | 32±2   | 0.8±0.05 |
| 4               | 22±1   | 26           | 8.0±1  | 27±3   | 1.0±0.05 |
| 5               | 22±1   | 26           | 8.0±1  | 30±2   | 0.8±0.05 |
| 7               | 22±1   | 26           | 9.0±1  | 30±2   | 0.8±0.05 |
| 9               | 38±1   | 42           | 9.0±1  | 30±2   | 0.8±0.05 |
| 10              | 37±1   | 41           | 10±1   | 30±2   | 0.8±0.05 |
| 20              | 42±1   | 46           | 12±1   | 30±2   | 0.8±0.05 |

◎ 7W、9W 為方型瓷殼

## 料號編碼 Type composition

例 Example

| RGC     | 03               | J             | R100              | A52             | NH              |
|---------|------------------|---------------|-------------------|-----------------|-----------------|
| 型名 Type | 額定功率 Rated Power | 誤差值 Tolerance | 電阻值(Ω) Resistance | 二次加工 Forming    | 端子線 Lead Wire   |
|         | 03:3W            | F±1%          | R001=0.001        | See table below | 熱鍍線 Heat plated |
|         | 05:5W            | G±2%          | R010=0.01         |                 |                 |
|         | 07:7W            | J±5%          | R100=0.1          |                 |                 |
|         | A0:10W           | K±10%         |                   |                 |                 |



■ 額定溫度下降曲線圖 Derating curve

例 Example

4W~7W

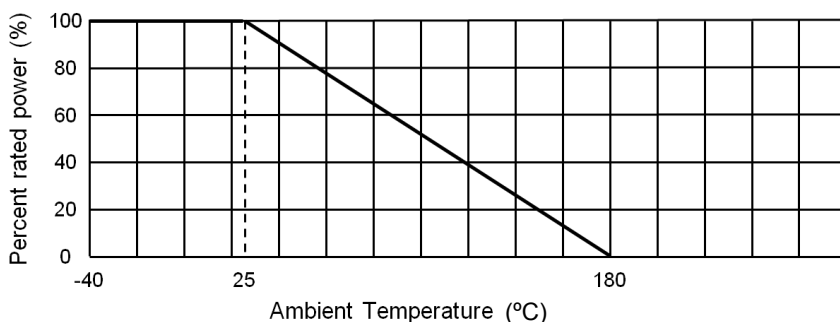

9W~11W



>15W

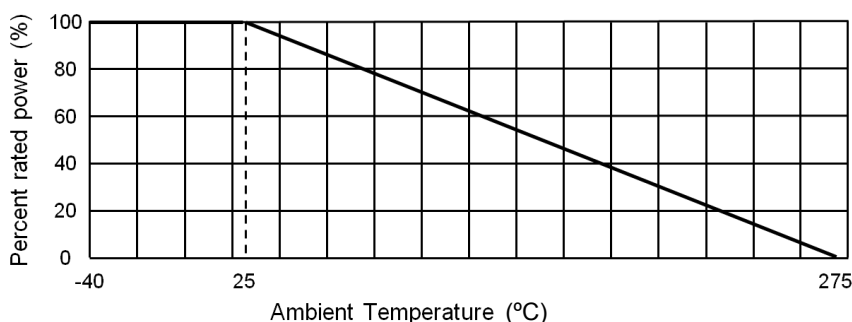

■ 試驗條件與方法 The testing method and condition.

| 試驗項目<br>Test Items                   | 規格值<br>Performance Requirements          | 試驗方法<br>Test Methods and Standard.(JISC5201-1)   |
|--------------------------------------|--|--|
| 電阻值<br>Resistance                    | 規定的誤差值內<br>Within of specified tolerance | 測量點從端蓋 10mm<br>Measuring points are distance 10mm from the end cap(4.5)                    |
| 溫度係數<br>T.C.R.                       | 規定值內<br>Within of specified T.C.R.       | 室溫+100°C<br>Room temperature +100°C(4.8)   |
| 短時間過負荷<br>Short time overload        | ±(1%+0.05Ω)                              | 6.25 倍額定功率，5 秒<br>6.25 times the rated power for 5 seconds(4.13)                           |
| 負荷壽命<br>Load life                    | ±(5%+0.1Ω)                               | Rated voltage at 70°C for 1,000 hours<br>1.5hr ON / 0.5hr OFF Cycles(4.25.1)               |
| 耐濕負荷壽命<br>Load life in humidity      | ±(5%+0.1Ω)                               | 10% rate power load<br>40°C, 95% RH for 1,000 hours<br>1.5h ON / 0.5h OFF cycle(4.24)      |
| 溫度循環<br>Temperature cycle            | ±(1%+0.05Ω)                              | 5 cycles for -25°C (30min) : room temp.(30min)<br>~ +85°C (30min) room temp. (30min)(4.19) |
| 焊錫耐熱<br>Resistance to soldering heat | ±(1%+0.05Ω)                              | 260°C ± 5°C for 10 seconds (焊錫槽)<br>350°C ± 10°C for 3.5 seconds (手焊錫)(4.18)               |
| 絕緣電阻<br>Insulation resistance        | >100MΩ                                   | 500V 絕緣測試 1 分鐘<br>500V insulation test 1min.(4.6.1)  |

# HIGH PULSE WIRE WOUND RESISTOR

## HVW 高脈衝繞線電阻器 HIGH PULSE WIRE WOUND RESISTOR (Standard Type)

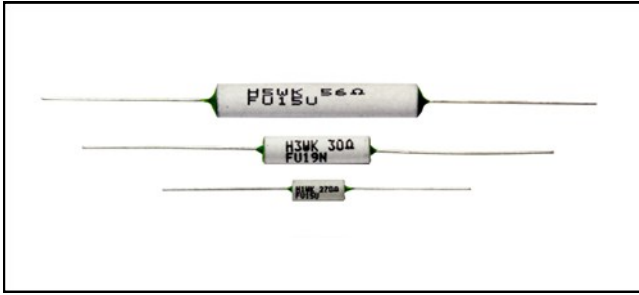

本體顏色 (Body color) :

白色 (White)

標示 (Marking) :

文字 (Alphanumeric)

### 特性 Feature

◎ 防爆式繞線高脈衝特性

The ANTI-BURST Type wire wound type High pulse safe usage by special non-flammable silicon-base.

◎ 可承受 25KV 突波的衝擊。

Acceptable pulse of 25KV discharge.

◎ 高信賴性

High reliability.

◎ 產品符合歐盟 RoHS 要求

Products is compliance the EU-RoHS request.

### 參考規格 Reference standards

● JIS C 5201-1

### 結構圖 Construction

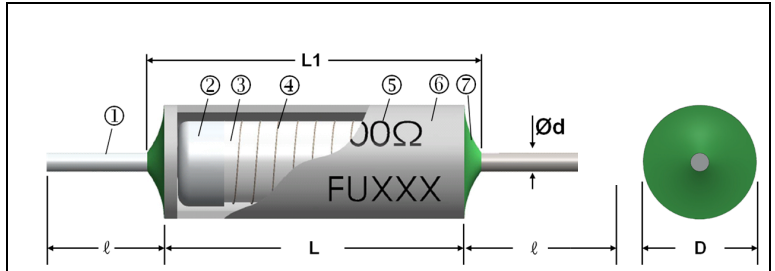

|   |     |              |   |      |                 |
|---|-----|--------------|---|------|-----------------|
| 1 | 端子線 | Lead wire    | 5 | 標示   | Marking         |
| 2 | 瓷棒  | Ceramic base | 6 | 絕緣塗料 | Insulation coat |
| 3 | 鐵帽  | Cap          |   |      |                 |
| 4 | 繞線  | Wire wound   | 7 | 瓷管   | Ceramic tube    |

### 外型尺寸 Dimensions

| Rated Power (W) | Dimensions(mm) |         |     |            |        | Weight(g)<br>(1000pcs) |
|-----------------|----------------|---------|-----|------------|--------|------------------------|
|                 | L              | L1 Max. | D   | Ød         | ℓ      |                        |
| 1               | 14±2           | 18      | 5±1 | 0.8 ± 0.05 | 35 ± 3 | 1250                   |
| 2               | 16±2           | 20      | 7±1 |            |        | 2250                   |
| 3               | 27±2           | 31      | 6±1 |            |        | 3000                   |
| 4               | 40±2           | 45      | 7±1 |            |        | 5500                   |
| 5               | 43±2           | 48      | 7±1 |            |        | 5900                   |

### 料號編碼 Type composition

例 Example

| HV         | W          | 01                  | J                | 10R0                 | S000               | NH               |
|------------|------------|---------------------|------------------|----------------------|--------------------|------------------|
| 型名<br>Type | 品名<br>Size | 額定功率<br>Rated Power | 誤差值<br>Tolerance | 電阻值(Ω)<br>Resistance | 二次加工<br>Forming    | 端子線<br>Lead Wire |
|            | W: Wire    | 01:1W               | J±5%             | 10R0=10              | See table<br>below | 熱鍍線              |
|            |            | 02:2W               | K±10%            | 1000=100             |                    | Heat plated      |
|            |            | 03:3W               | M±20%            | 1001=1K              |                    |                  |
|            |            | 04:4W               |                  | 1002=10K             |                    |                  |
|            |            | 05:5W               |                  | 1003=100K            |                    |                  |

### 額定 Ratings

| Rated Power (W) | 阻值範圍 Resistance Range(Ω) |            |            | 最高使用電壓 Max. Working Voltage | 最高過負荷電壓 Max. Overload Voltage | 耐電壓 Dielectric Withstanding Voltage | 溫度係數 T.C.R. | 脈衝電壓 Pulse withstanding voltage |
|-----------------|--------------------------|------------|------------|-----------------------------|-------------------------------|-------------------------------------|-------------|---------------------------------|
|                 | J±5%(E24)                | K±10%(E24) | M±20%(E24) |                             |                               |                                     |             |                                 |
| 1               | 10~390K                  |            |            | 300V                        | 600V                          | 250V                                | ±300 ppm/°C | 15KV                            |
| 2               |                          |            |            | 400V                        | 800V                          |                                     |             |                                 |
| 3               |                          |            |            | 450V                        | 900V                          | 350V                                |             | 25KV                            |
| 4               |                          |            |            | 550V                        | 1000V                         |                                     |             |                                 |
| 5               |                          |            |            | 1100V                       | 500V                          |                                     |             |                                 |

■ 額定溫度下降曲線圖 Derating curve

例 Example

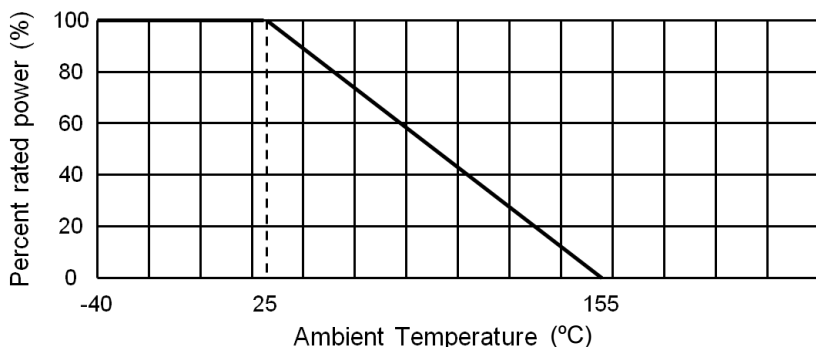

■ 試驗條件與方法 The testing method and condition.

| 試驗項目<br>Test Items                   | 規格值<br>Performance Requirements          | 試驗方法<br>Test Methods and Standard.(JISC5201-1)   |
|--------------------------------------|--|--|
| 電阻值<br>Resistance                    | 規定的誤差值內<br>Within of specified tolerance | 測量點從端蓋 10mm<br>Measuring points are distance 10mm from the end cap(4.5)  |
| 溫度係數<br>T.C.R.                       | 規定值內<br>Within of specified T.C.R.       | 室溫+100°C<br>Room temperature +100°C(4.8)   |
| 短時間過負荷<br>Short time overload        | ±(2%+0.05Ω)                              | 6.25 倍額定功率，5 秒<br>6.25 times the rated power for 5 seconds(4.13)   |
| 負荷壽命<br>Load life                    | ±(5%+0.1Ω)                               | Rated voltage at 70°C for 1,000 hours<br>1.5hr ON / 0.5hr OFF Cycles(4.25.1)   |
| 耐濕負荷壽命<br>Load life in humidity      | ±(5%+0.1Ω)                               | 10% rate power load<br>40°C, 95% RH for 1,000 hours<br>1.5h ON / 0.5h OFF cycle(4.24)  |
| 耐濕性<br>Moisture resistance           | ±(2%+0.05Ω)                              | 40°C，95% RH，240 小時<br>40°C, 95% RH for 240 hours   |
| 溫度循環<br>Temperature cycle            | ±(2%+0.05Ω)                              | 5 cycles for -25°C (30min) : room temp. (30min)<br>~ +85°C (30min) room temp. (30min)(4.19)  |
| 焊錫耐熱<br>Resistance to soldering heat | ±(2%+0.05Ω)                              | 260°C ± 5°C for 10 seconds (焊錫槽)<br>350°C ± 10°C for 3.5 seconds (手焊錫)(4.18)   |
| 絕緣電阻<br>Insulation resistance        | >1,000MΩ                                 | 500V 絕緣測試 1 分鐘<br>500V insulation test 1min.(4.6.1)  |
| 脈衝測試<br>Pulse withstanding voltage   | ±5%                                      | The following discharge cycle is repeated in the circuit of the left fig.<br>1 sec. ON 1 sec. OFF 10,000 cycles.<br>With following DC pulse test voltage.<br>Pulse voltage: DC 14 kV |



# ALUMINUM CASED POWER RESISTOR

GR

黃金鋁殼電阻器

ALUMINUM CASED POWER RESISTOR (GR Type)



外觀顏色 (Body Color) : 標 示 (Marking) :  
金 黃 色 (Gold) 文 字 (Alphanumeric)

## 特性 Feature

◎高穩定性強之設計和高脈衝 20KV

High stability strong construction and anti-surge to 20KV.

◎可依客戶需求製作

Can be produced according to customer's request.

◎產品符合歐盟 RoHS 要求

Products is compliance the EU-RoHS request.

◎可提供低電感

Low inductance is available.

## 料號編碼 Type composition 例 Example

| RG         | W          | 05                                   | J                             | 10R0   | P000  | GR                |
|------------|------------|--------------------------------------|-------------------------------|--|---|-------------------|
| 型名<br>Type | 品名<br>Size | 額定功率<br>Rated Power                  | 誤差值<br>Tolerance              | 電阻值(Ω)<br>Resistance   | 二次加工<br>Forming   | 端子線<br>Lead Wire  |
|            | Wire       | 05:5W<br>A0:10W<br>E0:50W<br>P0:300W | F±1%<br>G±2%<br>J±5%<br>K±10% | R100=0.1<br>1R00=1<br>10R0=10<br>1000=100<br>1001=1K<br>1002=10K<br>1005=10M<br>1007=1000M | P000=<br>Straight<br>P00T=<br>Terminal<br>NW00=<br>No sense<br>winding<br>NWOT=<br>Terminal | Aluminum<br>Cased |

## 結構圖 Construction

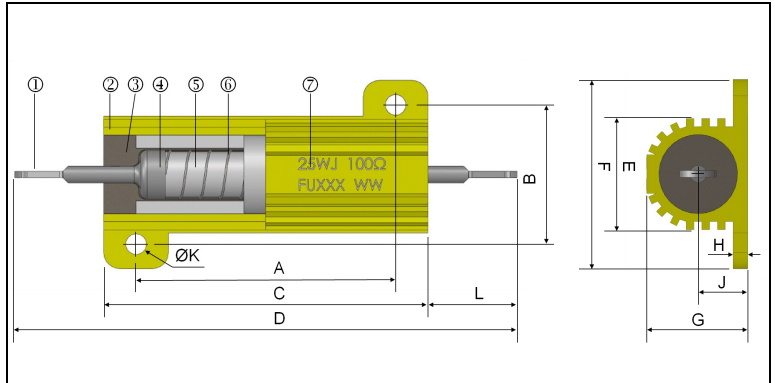

|   |       |                |   |       |                   |
|---|-------|----------------|---|-------|-------------------|
| 1 | 端子線   | Lead wire      | 5 | 瓷 棒   | Ceramic base      |
| 2 | 鋁 殼   | Aluminum case  | 6 | 繞線/皮膜 | Wire wound / Film |
| 3 | 矽 水 泥 | Silicon cement |   |       |                   |
| 4 | 鐵 帽   | Cap            | 7 | 標 示   | Marking           |

## 外形尺寸 Dimensions (mm)

| Rated Power (W) | 5    | 10   | 25   | 50   | 85   | 100   | 225~300 |
|-----------------|------|------|------|------|------|-------|---------|
| D±2             | 81   | 85   | 95   | 116  | 93.5 | 120±3 | 150     |
| C±1             | 15.5 | 19   | 27   | 50   | 75   | 89    | 114     |
| A±0.4           | 11.5 | 14.5 | 18   | 39   | 64   | 70    | 76      |
| L±1             | 5    | 33±3 | 33±3 | 33±3 | 9    | 12.5  | 18      |
| F±1             | 16.5 | 20.5 | 27.3 | 29   | 29   | 71.5  | 76      |
| B±0.4           | 12.5 | 14   | 19.5 | 21.6 | 10   | 57    | 64      |
| E±1             | 8.5  | 10   | 13.4 | 16   | 16   | 46    | 54      |
| N±0.1           | 2.2  | 2.2  | 2.2  | 2.2  | 2.2  | ---   | ---     |
| K±0.3           | 2.5  | 2.4  | 3.2  | 3.2  | 3.2  | 4.8   | 4.8     |
| G±1             | 8    | 10   | 15.5 | 15.5 | 15.5 | 44.5  | 55.6    |
| J±1             | 2.2  | 5    | 6.6  | 7.6  | 8    | 21    | 24.4    |
| H±0.2           | 1.5  | 2    | 2.2  | 2.2  | 2.2  | 4.7   | 6.4     |

## 額定 Ratings

| 型名<br>Type | Rated Power (W) | 材質<br>Material | 阻值範圍 Resistance Range(Ω) |               | 誤差值<br>Tolerance              | 溫度係數<br>T.C.R. | 最高使用電壓 Max.<br>Working Voltage | 耐電壓 Dielectric<br>Withstanding Voltage |
|------------|-----------------|----------------|--------------------------|---------------|-------------------------------|----------------|--------------------------------|--|
|            |                 |                | Standard                 | Non-inductive |                               |                |                                |  |
| GR-5       | 4.5             | Film           | 1.5K~1G                  | 200~10M       | F±1%<br>G±2%<br>J±5%<br>K±10% | ± 25ppm/°C     | 1500V                          | 1000V                                  |
|            | 5               | Wire Wound     | 0.1Ω~1.5K                | 0.02~200      |                               |                |                                |  |
| GR-10      | 8.5             | Film           | 2K~1G                    | 470~10M       |                               |                |                                |  |
|            | 10              | Wire Wound     | 0.1~2K                   | 0.02~470      |                               |                |                                |  |
| GR-25      | 20              | Film           | 4.7K~1G                  | 1.2K~10M      |                               |                |                                |  |
|            | 25              | Wire Wound     | 0.5~4.7K                 | 0.1~1.2K      |                               |                |                                |  |
| GR-50      | 45              | Film           | 10K~2G                   | 1.5K~1M       |                               |                |                                |  |
|            | 50              | Wire Wound     | 1~40K                    | 0.2~1.5K      |                               |                |                                |  |
| GR-100     | 100             | Wire Wound     | 3~25K                    | 0.5~4K        |                               |                |                                |  |
| GR-225     | 225~300         | Wire Wound     | 3~25K                    | 0.5~4K        |                               |                |                                |  |
| GR-300     |                 |                |                          |               | ± 350ppm/°C                   |                |                                |  |

Note: The highest resistance can be contact our sales.

■ 額定溫度下降曲線圖 Derating curve

例 Example

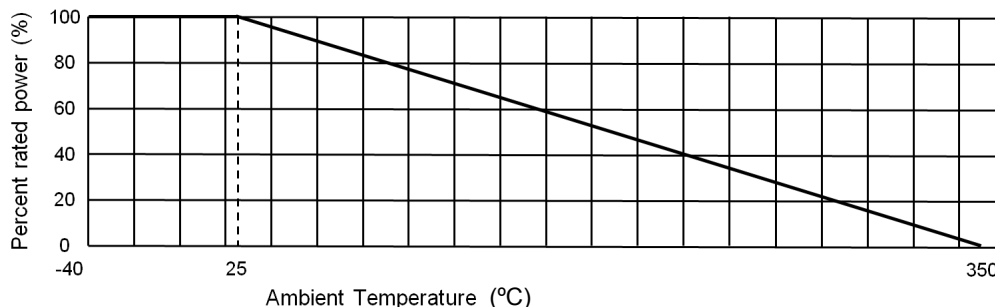

■ 負荷電力對表面溫度上升圖

**SURFACE TEMPERATURE RISE Vs. LOADED POWER**

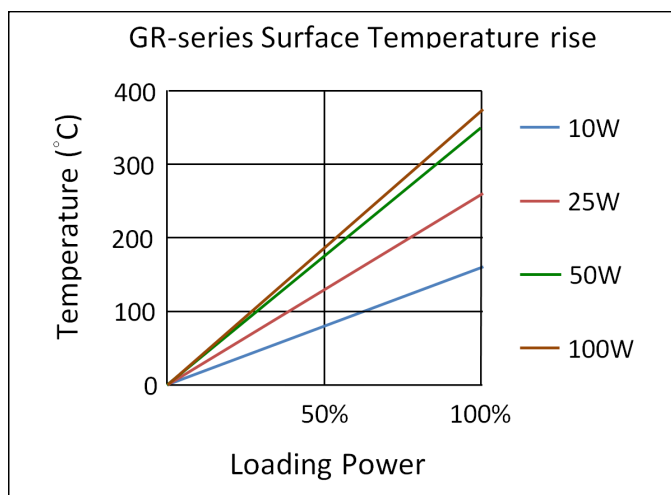

■ 試驗條件與方法 The testing method and condition.

| 試驗項目<br>Test Items                   | 規格值<br>Performance Requirements          | 試驗方法<br>Test Methods and Standard.(JISC5201-1)  |
|--------------------------------------|--|---|
| 電阻值<br>Resistance                    | 規定的誤差值內<br>Within of specified tolerance | 測量點從端蓋 10mm<br>Measuring points are distance 10mm from the end cap(4.5)                     |
| 溫度係數<br>T.C.R.                       | 規定值內<br>Within of specified T.C.R.       | 室溫+100°C<br>Room temperature +100°C(4.8)  |
| 短時間過負荷<br>Short time overload        | ±(1%+0.05Ω)                              | 6.25 倍額定功率，5 秒<br>6.25 times the rated power for 5 seconds(4.13)                            |
| 負荷壽命<br>Load life                    | ±(5%+0.1Ω)                               | Rated voltage at 70°C for 1,000 hours<br>1.5hr ON / 0.5hr OFF Cycles(4.25.1)                |
| 耐濕負荷壽命<br>Load life in humidity      | ±(5%+0.1Ω)                               | 10% rate power load<br>40°C, 95% RH for 1,000 hours<br>1.5h ON / 0.5h OFF cycle(4.24)       |
| 耐濕性<br>Moisture resistance           | ±(1%+0.05Ω)                              | 40°C，95% RH，240 小時<br>40°C, 95% RH for 240 hours  |
| 溫度循環<br>Temperature cycle            | ±(1%+0.05Ω)                              | 5 cycles for -25°C (30min) : room temp. (30min)<br>~ +85°C (30min) room temp. (30min)(4.19) |
| 焊錫耐熱<br>Resistance to soldering heat | ±(1%+0.05Ω)                              | 260°C ± 5°C for 10 seconds (焊錫槽)<br>350°C ± 10°C for 3.5 seconds (手焊錫)(4.18)                |
| 絕緣電阻<br>Insulation resistance        | >1,000MΩ                                 | 500V 絕緣測試 1 分鐘<br>500V insulation test 1min.(4.6.1)   |

# FLAT TYPE METAL CLAD WIRE WOUND RESISTOR

GH

薄型鋁殼電阻器

FLAT TYPE METAL CLAD WIRE WOUND RESISTOR (GH Type)



外觀顏色 (Body Color) :

銀 色 (Silver)

標 示 (Marking) :

文 字 (Alphanumeric)

## 特性 Feature

◎精密型高額定功率

High power rating, and ultra precision.

◎可依客戶需求製作

Can be produced depending on to customer's request.

◎產品符合歐盟 RoHS 要求

Products is compliance the EU-RoHS request.

◎可提供低電感 ( $\leq 1\text{KHz}$  :  $3\mu\text{H}$ )

Low inductance is available.

## 料號編碼 Type composition 例 Example

| RG         | W          | J0                 | J                | 10R0   | S245               | GH                |
|------------|------------|--------------------|------------------|--|--------------------|-------------------|
| 型名<br>Type | 品名<br>Size | 額定功率<br>Rated over | 誤差值<br>Tolerance | 電阻值(Ω)<br>Resistance                                 | 二次加工<br>Forming    | 薄型鋁殼<br>Aluminum  |
|            | Wire       | J0:100W<br>M0:150W | J±5%             | R100=0.1<br>1R00=1<br>10R0=10<br>1000=100<br>1001=1K | Straight<br>Length | Aluminum<br>Cased |

## 結構圖 Construction

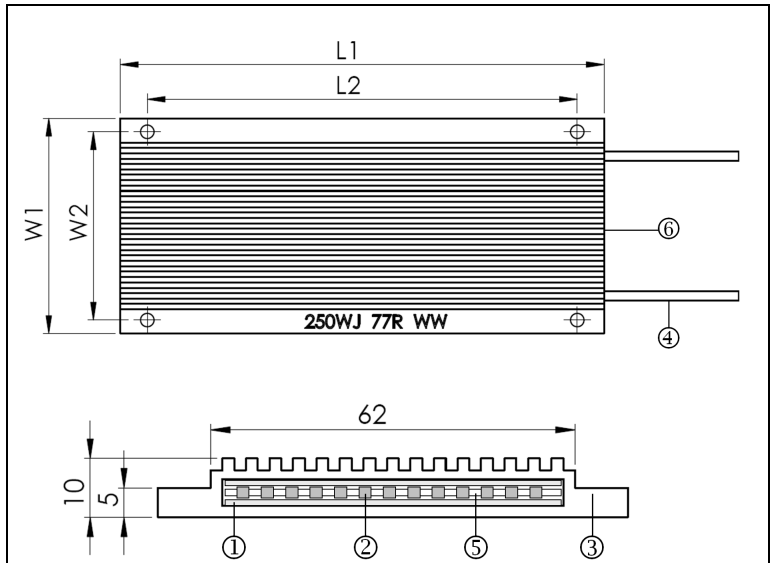

4 XØ5.0 ( 100W~250W )  
6 XØ5.0 ( 300W~500W )

|   |      |                     |   |      |                 |
|---|------|---------------------|---|------|-----------------|
| 1 | 絕緣板  | Insulation plate    | 5 | 基板   | Ceramic base    |
| 2 | 繞線   | Wire wound          | 6 | 絕緣塗料 | Insulation coat |
| 3 | 鋁殼   | Aluminum case       |   |      |                 |
| 4 | 絕緣電線 | Silicon rubber wire | 7 | 標示   | Marking         |

## 外型尺寸 Dimensions

| Rated Power (W) | L1±2 (mm) | L2±2 (mm) | W1±2 (mm) | W2±2 (mm) |
|-----------------|-----------|-----------|-----------|-----------|
| 100             | 90        | 70        | 80        | 70        |
| 150             | 120       | 100       |           |           |
| 200             | 150       | 130       |           |           |
| 250             | 180       | 160       |           |           |
| 300             | 210       | 190       |           |           |
| 400             | 270       | 250       |           |           |
| 500             | 330       | 310       |           |           |

## 額定 Ratings

| Rated Power (W) | 阻值範圍 Resistance Range(Ω) |               | 誤差值 Tolerance | 溫度係數 T.C.R. | 最高使用電壓 Max. Working Voltage | 最高過負荷電壓 Max. Overload Voltage | 耐電壓 Dielectric Withstanding Voltage |
|-----------------|--------------------------|---------------|---------------|-------------|-----------------------------|-------------------------------|-------------------------------------|
|                 | Standard                 | Non-inductive |               |             |                             |                               |                                     |
| 60              | 0.1Ω~ 500Ω               | 0.05Ω~ 10KΩ   | J±5%          | ±350ppm/°C  | 500V                        | 1500V                         | 1500V/DC                            |
| 100             | 1Ω~ 1.0KΩ                | 2Ω~ 500Ω      |               |             |                             |                               |                                     |
| 150             | 1Ω~ 1.2KΩ                | 2Ω~ 600Ω      |               |             |                             |                               |                                     |
| 200             | 1Ω~ 1.4KΩ                | 2Ω~ 700Ω      |               |             | 750V                        |                               |                                     |
| 250             | 1Ω~ 1.6KΩ                | 2Ω~ 800Ω      |               |             |                             |                               |                                     |
| 300             | 1Ω~ 1.8KΩ                | 2Ω~ 900Ω      |               |             |                             |                               |                                     |
| 400             | 1Ω~ 2.0KΩ                | 2Ω~ 1KΩ       |               |             | 1000V                       |                               |                                     |
| 500             | 1Ω~ 2.5KΩ                | 2Ω~ 1.2KΩ     |               |             |                             |                               |                                     |

■ 額定溫度下降曲線圖 Derating curve

例 Example



■ 試驗條件與方法 The testing method and condition.

| 試驗項目<br>Test Items              | 規格值<br>Performance Requirements          | 試驗方法<br>Test Methods and Standard.(JISC5201-1)  |
|---------------------------------|--|---|
| 電阻值<br>Resistance               | 規定的誤差值內<br>Within of specified tolerance | 測量點從端蓋 10mm<br>Measuring points are distance 10mm from the end cap(4.5)                     |
| 溫度係數<br>T.C.R.                  | 規定值內<br>Within of specified T.C.R.       | 室溫+100°C<br>Room temperature +100°C(4.8)  |
| 短時間過負荷<br>Short time overload   | ±(1%+0.05Ω)                              | 5 倍額定功率，5 秒<br>5 times the rated power for 5 seconds  |
| 負荷壽命<br>Load life               | ±(5%+0.1Ω)                               | Rated voltage at 70°C for 1,000 hours<br>1.5hr ON / 0.5hr OFF Cycles(4.25.1)                |
| 耐濕負荷壽命<br>Load life in humidity | ±(5%+0.1Ω)                               | 10% rate power load<br>40°C, 95% RH for 1,000 hours<br>1.5h ON / 0.5h OFF cycle(4.24)       |
| 耐濕性<br>Moisture resistance      | ±(1%+0.05Ω)                              | 40°C, 95% RH, 240 小時<br>40°C, 95% RH for 240 hours  |
| 溫度循環<br>Temperature cycle       | ±(1%+0.05Ω)                              | 5 cycles for -25°C (30min) : room temp. (30min)<br>~ +85°C (30min) room temp. (30min)(4.19) |
| 絕緣電阻<br>Insulation resistance   | >1,000MΩ                                 | 500V 絕緣測試 1 分鐘<br>500V insulation test 1min.(4.6.1)   |

# SQUARE SHAPE ALUMINUM SHELL RESISTOR

RA

方型鋁殼電阻器

SQUARE SHAPE ALUMINUM SHELL RESISTOR (RA Type)



## 結構圖 Construction

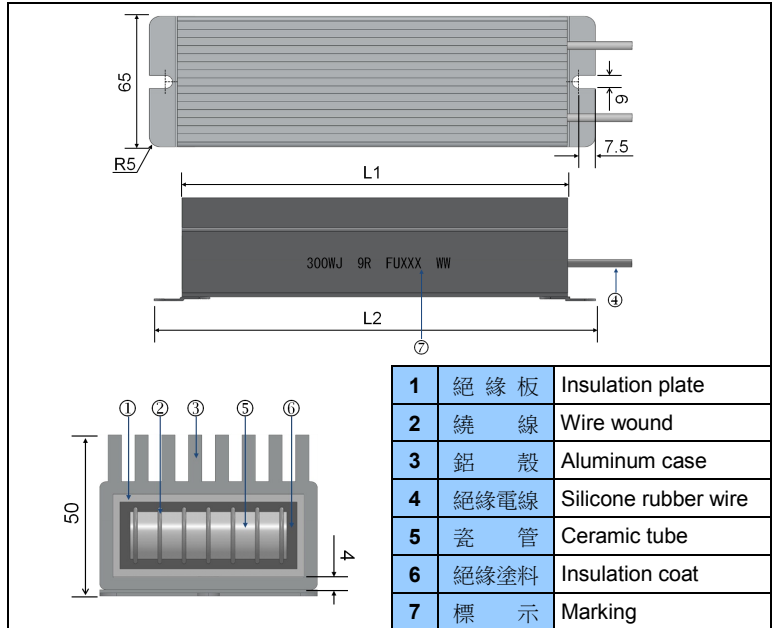

外觀顏色 (Body Color) : 標示 (Marking) :  
銀色 (Silver) 文字 (Alphanumeric)

## 特性 Feature

◎精密型高額定功率

High power rating, and ultra precision.

◎可依客戶需求製作

Can be produced according to customer's request.

◎產品符合歐盟 RoHS 要求

Products is compliance the EU-RoHS request.

◎可提供低電感

Low inductance is available.

## 外型尺寸 Dimensions

| Rated Power (W) | L1±2 (mm) | L2±2 (mm) |
|-----------------|-----------|-----------|
| 60              | 50        | 75        |
| 80              | 70        | 95        |
| 100             | 85        | 110       |
| 120             | 100       | 130       |
| 150             | 140       | 165       |
| 200             | 160       | 200       |
| 300             | 240       | 280       |
| 400             | 320       | 360       |
| 500             | 400       | 440       |
| 600             | 480       | 520       |
| 800             | 560       | 600       |

## 料號編碼 Type composition

例 Example

| RA         | SQ              | 301   | J                | 10R0   | NP00                                 |
|------------|-----------------|---|------------------|--|--------------------------------------|
| 型名<br>Type | 品名<br>Size      | 額定功率<br>Rated ower                          | 誤差值<br>Tolerance | 電阻值(Ω)<br>Resistance                                 | 無感/端片<br>No sense-<br>end piece      |
|            | Square<br>Shape | 600:60W<br>101:100W<br>301:300W<br>801:800W | J±5%             | R100=0.1<br>1R00=1<br>10R0=10<br>1000=100<br>1001=1K | S300:<br>300mm<br>Straight<br>Length |

## 額定 Ratings

| Rated Power (W) | 阻值範圍 Resistance Range(Ω) |               | 誤差值<br>Tolerance | 溫度係數<br>T.C.R. | 最高使用電壓 Max.<br>Working Voltage | 最高過負荷電壓 Max.<br>Overload Voltage | 耐電壓 Dielectric<br>Withstanding Voltage |
|-----------------|--------------------------|---------------|------------------|----------------|--------------------------------|----------------------------------|--|
|                 | Standard                 | Non-inductive |                  |                |                                |                                  |  |
| 60              | 0.001 ~ 5K               | 0.1 ~ 100Ω    | J±5%             | ±350ppm/°C     | 1000V                          | 2000V                            | AC 1500V                               |
| 80              | 0.001 ~ 6K               | 0.2 ~ 100Ω    |                  |                |                                |                                  |  |
| 100             | 0.001 ~ 8K               | 0.2 ~ 100Ω    |                  |                |                                |                                  |  |
| 120             | 0.001 ~ 10K              | 0.2 ~ 100Ω    |                  |                |                                |                                  |  |
| 150             | 0.001 ~ 12K              | 0.2 ~ 100Ω    |                  |                |                                |                                  |  |
| 200             | 0.001 ~ 15K              | 0.2 ~ 150Ω    |                  |                |                                |                                  |  |
| 300             | 0.001 ~ 18K              | 0.5 ~ 150Ω    |                  |                |                                |                                  |  |
| 400             | 0.001 ~ 20K              | 0.5 ~ 200Ω    |                  |                |                                |                                  |  |
| 500             | 0.001 ~ 25K              | 0.5 ~ 500Ω    |                  |                |                                |                                  |  |
| 600             | 0.001 ~ 30K              | 1 ~ 1K        |                  |                |                                |                                  |  |
| 800             | 0.001 ~ 30K              | 1 ~ 1K        |                  |                |                                |                                  |  |



■ 額定溫度下降曲線圖 Derating curve

例 Example

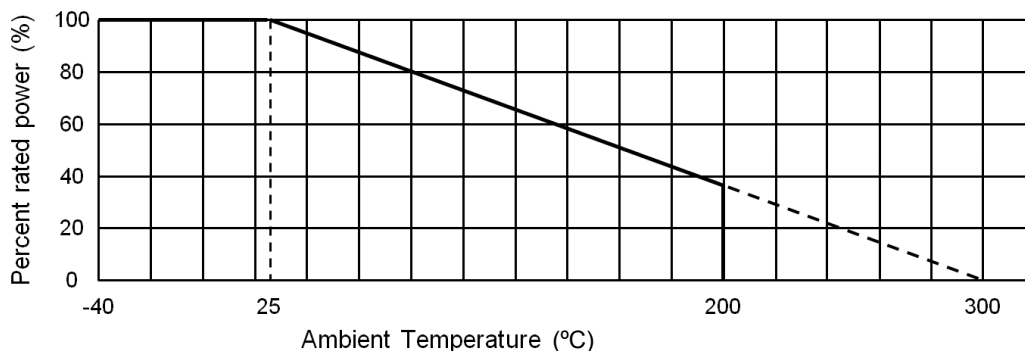

■ 負荷電力對表面溫度上升圖

SURFACE TEMPERATURE RISE Vs. LOADED POWER



■ 試驗條件與方法 The testing method and condition.

| 試驗項目<br>Test Items                     | 規格值<br>Performance Requirements          | 試驗方法<br>Test Methods and Standard.(JISC5201-1)  |
|--|--|---|
| 電阻值<br>Resistance                      | 規定的誤差值內<br>Within of specified tolerance | 測量點從端蓋 10mm<br>Measuring points are distance 10mm from the end cap(4.5)                     |
| 溫度係數<br>T.C.R.                         | 規定值內<br>Within of specified T.C.R.       | 室溫+100°C<br>Room temperature +100°C(4.8)  |
| 短時間過負荷<br>Short time overload          | ±(2%+0.05Ω)                              | 10 倍額定功率 · 5 秒<br>10 times the rated power for 5 seconds                                    |
| 負荷壽命<br>Load life                      | ±(5%+0.1Ω)                               | Rated voltage at 70°C for 1,000 hours<br>1.5hr ON / 0.5hr OFF Cycles(4.25.1)                |
| 耐濕負荷壽命<br>Load life in humidity        | ±(3%+0.1Ω)                               | 10% rate power load<br>40°C, 95% RH for 1,000 hours<br>1.5h ON / 0.5h OFF cycle(4.24)       |
| 耐濕性<br>Moisture resistance             | ±(3%+0.05Ω)                              | 40°C, 95% RH, 500 小時<br>40°C, 95% RH for 500 hours  |
| 溫度循環<br>Temperature cycle              | ±(1%+0.05Ω)                              | 5 cycles for -25°C (30min) : room temp. (30min)<br>~ +85°C (30min) room temp. (30min)(4.19) |
| 耐電壓<br>Dielectric withstanding voltage | ±(0.2%+0.05Ω)                            | Test voltage : 1,500 V<br>Duration time 60 s  |
| 絕緣電阻<br>Insulation resistance          | >1,000MΩ                                 | 500V 絕緣測試 1 分鐘<br>500V insulation test 1min.(4.6.1)   |
| 耐熱性<br>Heat Resistance                 | ±(0.5%+0.05Ω)                            | Temp. 275°C for 2 hours.  |

# TRAPEZOID ALUMINUM SHELL RESISTOR

RAMH

船型鋁殼電阻器

TRAPEZOID ALUMINUM SHELL RESISTOR (RAMH Type)



外觀顏色 (Body Color) : 標示 (Marking) :  
 銀色 (Silver) 文字 (Alphanumeric)

## 特性 Feature

◎精密型高額定功率

High power rating, and ultra precision.

◎可依客戶需求製作(尺寸、功率、電感值)

Can be produced according to customer's request.

◎產品符合歐盟 RoHS 要求

Products is compliance the EU-RoHS request.

◎可提供低電感

Low inductance is available.

## 料號編碼 Type composition

例 Example

| RA         | MH           | 301  | J                | 10R0   | S000                                 |
|------------|--------------|--|------------------|--|--------------------------------------|
| 型名<br>Type | 品名<br>Size   | 額定功率<br>Rated power                                      | 誤差值<br>Tolerance | 電阻值(Ω)<br>Resistance                                 | 直線<br>Straight                       |
|            | Ship<br>Type | 600:60W<br>101:100W<br>301:300W<br>801:800W<br>102:1000W | J±5%             | R100=0.1<br>1R00=1<br>10R0=10<br>1000=100<br>1001=1K | S200:<br>200mm<br>Straight<br>Length |

## 額定 Ratings

| Rated Power (W) | 阻值範圍 Resistance Range(Ω) |               | 誤差值 Tolerance | 溫度係數 T.C.R. | 最高使用電壓 Max. Working Voltage | 最高過負荷電壓 Max. Overload Voltage | 耐電壓 Dielectric Withstanding Voltage |
|-----------------|--------------------------|---------------|---------------|-------------|-----------------------------|-------------------------------|-------------------------------------|
|                 | Standard                 | Non-inductive |               |             |                             |                               |                                     |
| 60              | 0.001 ~ 5K               | 0.1 ~ 100Ω    | J±5%          | ±350ppm/°C  | 1000V                       | 2000V                         | AC 1500V                            |
| 80              | 0.001 ~ 6K               | 0.2 ~ 100Ω    |               |             |                             |                               |                                     |
| 100             | 0.001 ~ 8K               | 0.2 ~ 100Ω    |               |             |                             |                               |                                     |
| 120             | 0.001 ~ 10K              | 0.2 ~ 100Ω    |               |             |                             |                               |                                     |
| 150             | 0.001 ~ 12K              | 0.2 ~ 100Ω    |               |             |                             |                               |                                     |
| 200             | 0.001 ~ 15K              | 0.2 ~ 150Ω    |               |             |                             |                               |                                     |
| 300             | 0.001 ~ 18K              | 0.5 ~ 150Ω    |               |             |                             |                               |                                     |
| 400             | 0.001 ~ 20K              | 0.5 ~ 200Ω    |               |             |                             |                               |                                     |
| 500             | 0.001 ~ 25K              | 0.5 ~ 500Ω    |               |             |                             |                               |                                     |
| 600             | 0.001 ~ 30K              | 1 ~ 1K        |               |             |                             |                               |                                     |
| 800             | 0.001 ~ 30K              | 1 ~ 1K        |               |             |                             |                               |                                     |

## 結構圖 Construction



## 外型尺寸 Dimensions

| Rated Power (W) | L1±2 (mm) | L2±2 (mm) | P±1.5 (mm) |
|-----------------|-----------|-----------|------------|
| 60              | 50        | 80        | 62         |
| 80              | 60        | 90        | 72         |
| 100             | 75        | 105       | 87         |
| 120             | 90        | 120       | 102        |
| 150             | 120       | 150       | 132        |
| 200             | 140       | 170       | 152        |
| 300             | 180       | 210       | 192        |
| 400             | 230       | 260       | 242        |
| 500             | 300       | 330       | 312        |
| 600             | 360       | 390       | 372        |
| 800             | 400       | 430       | 412        |
| 1000            | 530       | 560       | 542        |

NOTE: 1. The impedance value request is over above table, please contact our sales.  
 2. The TCR request please ask before order.

■ 額定溫度下降曲線圖 Derating curve

例 Example

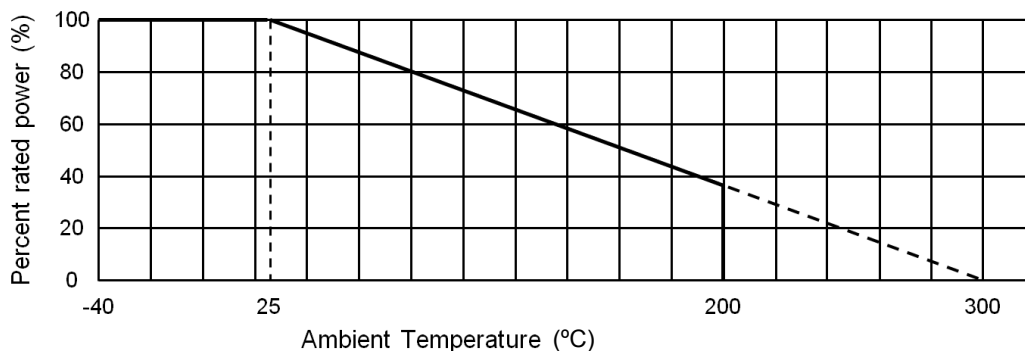

■ 負荷電力對表面溫度上升圖

SURFACE TEMPERATURE RISE Vs. LOADED POWER



NOTE:

1. Pulse function can design for client request. Please contact our sales.
2. We can offer the Temperature probe design of impedance wire inner.

■ 試驗條件與方法 The testing method and condition.

| 試驗項目<br>Test Items                     | 規格值<br>Performance Requirements          | 試驗方法<br>Test Methods and Standard.(JISC5201-1)  |
|--|--|---|
| 電阻值<br>Resistance                      | 規定的誤差值內<br>Within of specified tolerance | 測量點從端蓋 10mm<br>Measuring points are distance 10mm from the end cap(4.5)                     |
| 溫度係數<br>T.C.R.                         | 規定值內<br>Within of specified T.C.R.       | 室溫+100°C<br>Room temperature +100°C(4.8)  |
| 短時間過負荷<br>Short time overload          | ±(2%+0.05Ω)                              | 10 倍額定功率 · 5 秒<br>10 times the rated power for 5 seconds                                    |
| 負荷壽命<br>Load life                      | ±(5%+0.1Ω)                               | Rated voltage at 70°C for 1,000 hours<br>1.5hr ON / 0.5hr OFF Cycles(4.25.1)                |
| 耐濕負荷壽命<br>Load life in humidity        | ±(5%+0.1Ω)                               | 10% rate power load<br>40°C, 95% RH for 1,000 hours<br>1.5h ON / 0.5h OFF cycle(4.24)       |
| 耐濕性<br>Moisture resistance             | ±(3%+0.05Ω)                              | 40°C, 95% RH, 500 小時<br>40°C, 95% RH for 500 hours  |
| 溫度循環<br>Temperature cycle              | ±(1%+0.05Ω)                              | 5 cycles for -25°C (30min) : room temp. (30min)<br>~ +85°C (30min) room temp. (30min)(4.19) |
| 耐電壓<br>Dielectric withstanding voltage | ±(0.2%+0.05Ω)                            | Test voltage : 1,500 V<br>Duration time 60 s  |
| 絕緣電阻<br>Insulation resistance          | >1,000MΩ                                 | 500V 絕緣測試 1 分鐘<br>500V insulation test 1min.(4.6.1)   |
| 耐熱性<br>Heat Resistance                 | ±(0.5%+0.05Ω)                            | Temp. 275°C for 2 hours.  |

# POWER WIRE WOUND RESISTOR

RQ

大功率型電阻器

POWER WIRE WOUND RESISTOR (Fixed & Non-inductive Type ; Adjustable Type)



塗料顏色 (Coating Color) : 標示 (Marking) :  
綠色 (Green) 文字 (Alphanumeric)

◎可提供低電感

◎防爆式繞線高脈衝特性

The ANTI-BURST Type wire wound type High pulse safe usage by special non-flammable silicon-base.

◎可承受 25KV 突波的衝擊

Acceptable pulse of 25KV discharge.

◎高信賴性

High reliability.

◎產品符合歐盟 RoHS 要求

Products is compliance the EU-RoHS request.

◎可提供低電感

Low inductance is available.

料號編碼 Type composition 例 Example

| RQ      | FR                | 100              | J             | 10R0              | C2              | HG       |
|---------|-------------------|------------------|---------------|-------------------|-----------------|----------|
| 型名 Type | 品名 Size           | 額定功率 Rated Power | 誤差值 Tolerance | 電阻值(Ω) Resistance | 銅環數 Copper ring | 樣式 style |
|         | FR: Fixed         | 100:10W          | J±5%          | 10R0=10           | C2:2Ring        | HG:臥式    |
|         | NR: Non-inductive | 101:100W         | K±10%         | 1000=100          | C3:3Ring        | VZ:立式    |
|         | MR: Adjustable    | 102:1000W        |               | 1001=1K           | C4:4Ring        | VN:無     |
|         |                   |                  |               | 1002=10K          |                 |          |
|         |                   |                  |               | 1003=100K         |                 |          |

結構圖 Construction

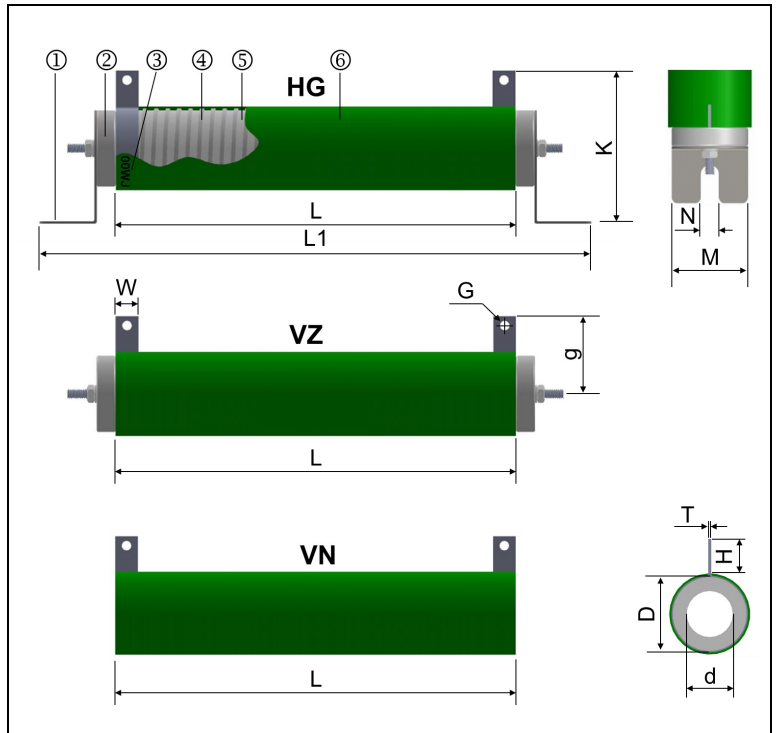

|   |      |                |   |      |                 |
|---|------|----------------|---|------|-----------------|
| 1 | 鐵架   | Iron stand     | 4 | 繞線   | Wire wound      |
| 2 | 陶瓷墊圈 | Ceramic washer |   | 瓷棒   | Ceramic base    |
| 3 | 標示   | Marking        | 6 | 絕緣塗料 | Insulation coat |

額定溫度下降曲線圖 Derating curve

例 Example



外型尺寸 Dimensions

| Dimensions (mm) | Rated Power (W) |    |     |     |     |     |     |     |     |       |     |     |     |     |     |     |     |     |      |      |      |      |     |
|-----------------|-----------------|----|-----|-----|-----|-----|-----|-----|-----|-------|-----|-----|-----|-----|-----|-----|-----|-----|------|------|------|------|-----|
|                 | 10              | 20 | 30  | 50  | 60  | 80  | 100 | 120 | 150 | 160   | 200 | 250 | 300 | 400 | 500 | 600 | 700 | 800 | 1000 | 1300 | 1500 | 2000 |     |
| L±2             | 45              | 60 | 75  | 110 | 90  | 110 | 140 | 160 | 195 | L±4   | 185 | 210 | 210 | 260 | 330 | 330 | 400 | 460 | 460  | 540  | 600  | 600  | 650 |
| D±1             | 12              | 17 | 17  | 25  | 28  | 28  | 28  | 28  | 28  | D±2   | 35  | 35  | 40  | 40  | 40  | 50  | 50  | 50  | 60   | 60   | 65   | 65   | 65  |
| g±1             | 18              | 22 | 22  | 30  | 32  | 32  | 32  | 32  | 32  | g±2   | 36  | 36  | 38  | 38  | 38  | 50  | 50  | 50  | 55   | 55   | 62   | 62   | 62  |
| W±1             | 4               | 5  | 5   | 8   | 8   | 8   | 8   | 8   | 8   | W±2   | 10  | 10  | 12  | 12  | 12  | 12  | 10  | 12  | 15   | 15   | 15   | 15   | 15  |
| G±1             | 2               | 2  | 2   | 5   | 5   | 5   | 5   | 5   | 5   | G±1   | 5   | 5   | 5   | 5   | 5   | 6   | 4   | 6   | 6    | 6    | 6    | 6    | 6   |
| H±1             | 9               | 12 | 12  | 18  | 19  | 19  | 19  | 19  | 17  | H±1   | 19  | 19  | 20  | 20  | 20  | 25  | 25  | 25  | 30   | 30   | 30   | 30   | 30  |
| N±0.5           | 3               | 4  | 4   | 6   | 6   | 6   | 6   | 6   | 6   | N±2   | 8   | 10  | 8   | 8   | 8   | 9   | 9   | 9   | 10   | 10   | 10   | 10   | 10  |
| L1±2            | 62              | 90 | 112 | 166 | 146 | 166 | 196 | 216 | 251 | L1±1  | 245 | 284 | 274 | 335 | 403 | 410 | 480 | 530 | 535  | 615  | 722  | 722  | 722 |
| K±2             | 28              | 36 | 36  | 60  | 60  | 60  | 60  | 60  | 60  | K±4   | 76  | 76  | 78  | 78  | 82  | 110 | 110 | 100 | 110  | 110  | 115  | 115  | 115 |
| T±0.3           | 1               | 1  | 1   | 1.2 | 1.2 | 1.2 | 1.2 | 1.2 | 1.2 | T±0.3 | 1.6 | 1.6 | 1.6 | 1.6 | 1.6 | 1.6 | 1.6 | 1.6 | 1.6  | 1.6  | 1.6  | 1.6  | 1.6 |
| M±1             | 10              | 17 | 17  | 28  | 28  | 28  | 28  | 28  | 28  | M±2   | 40  | 40  | 40  | 40  | 40  | 48  | 48  | 48  | 50   | 50   | 50   | 50   | 50  |

NOTE: Over above table list request please contact sales.

**■ 額定 Ratings**

| Rated Power (W) | 阻值範圍 Resistance Range (Ω) |                       |                    | 誤差值 Tolerance | 溫度係數 T.C.R. | 最高使用電 Max. Working Voltage | 耐電壓 Dielectric Withstanding Voltage |
|-----------------|---------------------------|-----------------------|--------------------|---------------|-------------|----------------------------|-------------------------------------|
|                 | 標準 Standard ; FR          | 無感 Non-inductive ; NR | 可調 Adjustable ; MR |               |             |                            |                                     |
| 10              | 1-3KΩ                     |                       | -----              | J±5%<br>K±10% | ±350ppm/°C  | 1500V                      | 750V                                |
| 20              | 1-7KΩ                     |                       | 1-360Ω             |               |             |                            |                                     |
| 30              | 1-10KΩ                    |                       | 1-500Ω             |               |             |                            |                                     |
| 50              | 0.1-25KΩ                  | 0.1-8KΩ               | 1-1.3KΩ            |               |             |                            |                                     |
| 60              | 0.1-30KΩ                  | 0.1-10KΩ              | 1-1.5KΩ            |               |             |                            |                                     |
| 80              | 0.1-40KΩ                  | 0.1-20KΩ              | 0.1-2KΩ            |               |             |                            |                                     |
| 100             | 0.1-50KΩ                  | 0.1-25KΩ              | 0.1-2.4KΩ          |               |             |                            |                                     |
| 120             | 0.1-60KΩ                  | 0.1-30KΩ              | 0.1-3KΩ            |               |             |                            |                                     |
| 150             | 0.3-75KΩ                  | 0.3-35KΩ              | 0.3-3.6KΩ          |               |             |                            |                                     |
| 160             | 0.3-80KΩ                  | 0.3-40KΩ              | 0.3-3.9KΩ          |               |             |                            |                                     |
| 200             | 0.3-100KΩ                 | 0.3-50KΩ              | 0.3-5KΩ            |               |             |                            |                                     |
| 250             | 0.5-125KΩ                 | 0.5-60KΩ              | 0.3-6.2KΩ          |               |             |                            |                                     |
| 300             | 0.5-150KΩ                 | 0.5-75KΩ              | 0.3-7.5KΩ          |               |             |                            |                                     |
| 400             | 0.5-200KΩ                 | 0.5-100KΩ             | 0.5-10KΩ           |               |             |                            |                                     |
| 500             | 0.5-250KΩ                 | 0.5-120KΩ             | 0.5-13KΩ           |               |             |                            |                                     |
| 600             | 0.8-300KΩ                 | 0.8-150KΩ             | 0.5-15KΩ           |               |             |                            |                                     |
| 700             | 0.8-350KΩ                 | 0.8-180KΩ             | 0.5-18KΩ           |               |             |                            |                                     |
| 800             | 0.8-400KΩ                 | 0.8-200KΩ             | 0.8-20KΩ           |               |             |                            |                                     |
| 1000            | 1-500KΩ                   | 1-250KΩ               | 1-25KΩ             |               |             |                            |                                     |
| 1300            | 1-500KΩ                   | 1-250KΩ               | 1-25KΩ             |               |             |                            |                                     |
| 1500            | 1-500KΩ                   | 1-250KΩ               | 1-25KΩ             |               |             |                            |                                     |
| 2000            | 1-750KΩ                   | 1-300KΩ               | 1-39KΩ             |               |             |                            |                                     |

NOTE: impedance request is over above table, please contact sales.

**■ 試驗條件與方法 The testing method and condition.**

| 試驗項目 Test Items                     | 規格值 Performance Requirements                                  | 試驗方法 Test Methods and Standard.(JISC5201-1)                                     |
|-------------------------------------|---|---|
| 電阻值 Resistance                      | 規定的誤差值內 Within of specified tolerance                         | 測量點從端蓋 10mm Measuring points are distance 10mm from the end cap(4.5)            |
| 溫度係數 T.C.R.                         | 規定值內 Within of specified T.C.R.                               | 室溫+100°C Room temperature +100°C(4.8)   |
| 短時間過負荷 Short time overload          | ±(2%+0.1Ω)  | 6.25 倍額定功率，5 秒 6.25 times the rated power for 5 seconds(4.13)                   |
| 負荷壽命 Load life                      | ±(1%+0.1Ω)  | Rated voltage at 70°C for 1,000 hours 1.5hr ON / 0.5hr OFF Cycles(4.25.1)       |
| 耐濕負荷壽命 Load life in humidity        | ±(1%+0.1Ω)  | 10% rate power load 40°C, 95% RH for 1,000 hours 1.5h ON / 0.5h OFF cycle(4.24) |
| 耐濕性 Moisture resistance             | ±(3%+0.1Ω)  | 40°C, 95% RH, 500 小時 40°C, 95% RH for 500 hours                                 |
| 耐電壓 Dielectric withstanding voltage | Flash over, burning, insulation damage should not be observed | Test voltage : 750 V (MR 可調品除外) Duration time 60 s                              |
| 絕緣電阻 Insulation resistance          | >100MΩ  | 500V 絕緣測試 1 分鐘 (MR 可調品除外) 500V insulation test 1min.(4.6.1)                     |

# COAT- INSULATED ZERO OHM RESISTOR

- RZU** ■ 塗裝防火型 0Ω電阻器
- RZS** ■ FIRE PREVENTION COAT ZERO OHM RESISTOR (RZU Type , RZS Type)
- RZY** ■ 絕緣樹脂型 0Ω電阻器
- RZY** ■ INSULATION RESIN ZERO OHM RESISTOR (RZY Type)
- RZT** ■ 鐵芯型 0Ω電阻器
- RZT** ■ IRON CORE ZERO OHM RESISTOR (RZT Type)

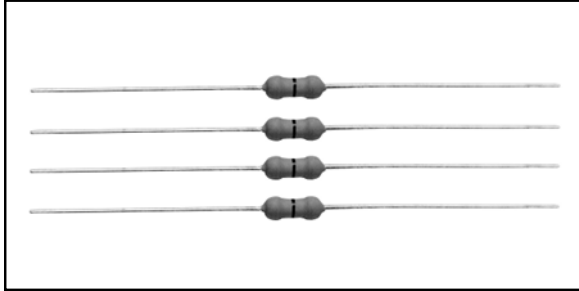

## ■結構圖 Construction

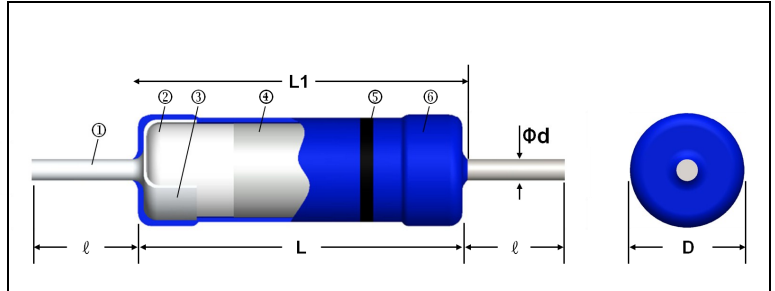

|   |     |              |   |      |                       |
|---|-----|--------------|---|------|-----------------------|
| 1 | 端子線 | Lead wire    | 5 | 電鍍錫  | Tin plating           |
| 2 | 瓷棒  | Ceramic base | 6 | 標示   | Marking or color code |
| 3 | 鐵帽  | Cap          |   |      |                       |
| 4 | 鐵蕊  | Iron core    | 7 | 絕緣塗料 | Insulation coat       |

塗料顏色 (Coating Color) :

RZU fire prevention coat (Gray) · RZS (pink)

RZU 塗裝防火型(灰色) · RZS (粉紅色)

RZY Insulation resin (Yellowish) · RZT iron core. (or blue)

RZY 絕緣樹脂(淡黃色) · RZT 鐵芯型(or 藍色)

標 示 (Marking) : 色環 Color Code(≤ S1/2W)

文字 Alphanumeric (1/2W · 1W)

## ■外型尺寸 Dimensions

| Rated Power(W) | Dimensions(mm) |         |         |           |      | Weight(g)<br>(1000pcs) |
|----------------|----------------|---------|---------|-----------|------|------------------------|
|                | L              | L1 Max. | D       | Ød        | ℓ    |                        |
| 1/8, 1/6       | 3.3±0.3        | 4       | 1.8±0.3 | 0.45±0.05 | 28±2 | 120                    |
| 1/4            | 6.0±0.3        | 7       | 2.4±0.1 | 0.6±0.05  | 28±2 | 218                    |
| 1/2            | 9±0.5          | 11.1    | 3.0±0.5 | 0.6±0.05  | 28±3 | 320                    |
| S1             | 9±0.5          | 11.1    | 3.0±0.5 | 0.6±0.05  | 28±3 | 320                    |

## ■特性 Feature

◎可自動插件

Automatic insertion is applicable.

◎長期穩定性佳

Excellent long term stability.

◎產品符合歐盟 RoHS 要求

Products is compliance the EU-RoHS request.

## ■料號編碼 Type composition

例 Example

| RZ         | U           | 14                  | X                | R000                 | A520               | NH                 |
|------------|-------------|---------------------|------------------|----------------------|--------------------|--------------------|
| 型名<br>Type | 品名<br>Size  | 額定功率<br>Rated Power | 誤差值<br>Tolerance | 電阻值(Ω)<br>Resistance | 二次加工<br>Forming    | 端子線<br>Lead Wire   |
|            | U: Standard | 16:1/6W             | 無註記              | 0Ω                   | See table<br>below | 熱鍍線<br>Heat plated |
|            | S: Small    | 14:1/4W             |                  |                      |                    |                    |
|            |             | 12:1/2W             |                  |                      |                    |                    |
|            |             | 01:1W               |                  |                      |                    |                    |

## ■參考規格 Reference standards

● JIS C 5201-1

## ■額定 Ratings

| Rated Power (W) | 阻值範圍 Resistance Range (Ω) | 最高使用電流<br>Maxi. Amperage | 耐電壓 Dielectric<br>Withstanding Voltage | 包裝 Taping/Ammo, Forming/Bulk pack (pcs) |      |
|-----------------|---------------------------|--------------------------|--|---|------|
|                 |                           |                          |  | A26                                     | A52  |
| RZU1/6          | <20mΩ                     | 1.5A                     | 300V                                   | 5000                                    | 5000 |
| RZU1/4          |                           | 2.5A                     |  |   |      |
| RZU1/2          |                           | 2.5A                     |  |   |      |
| RZS1            |                           | 2.5A                     |  |   |      |
| RZT1/6          | <5mΩ                      | 10A                      | 300V                                   | 5000                                    | 5000 |
| RZT1/4          |                           | 15A                      |  |   |      |
| RZY1/6          | <20mΩ                     | 3A                       | 300V                                   | 5000                                    | 5000 |
| RZY1/4          |                           | 5A                       |  |   |      |

■ 額定溫度下降曲線圖 Derating curve

例 Example

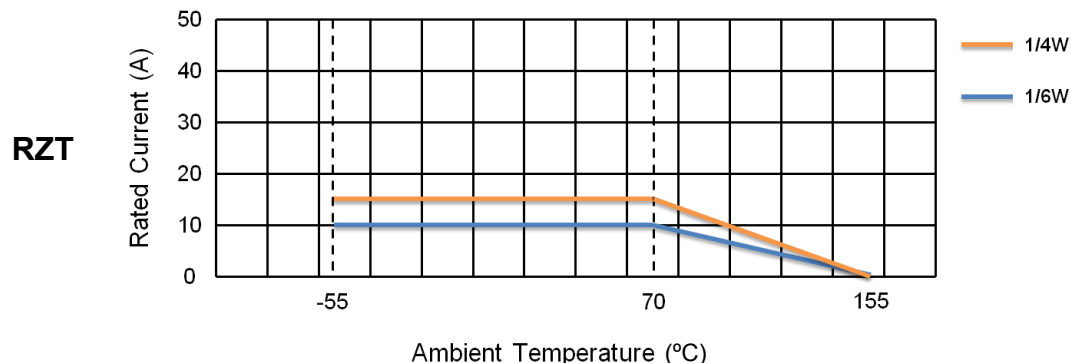
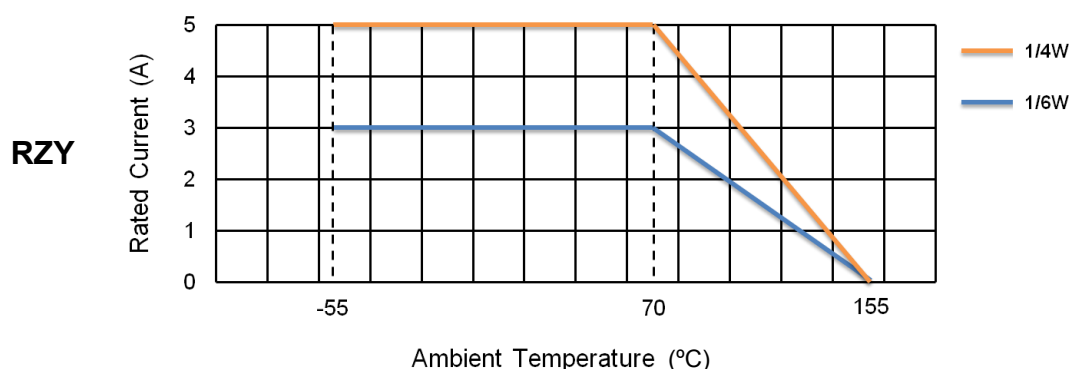
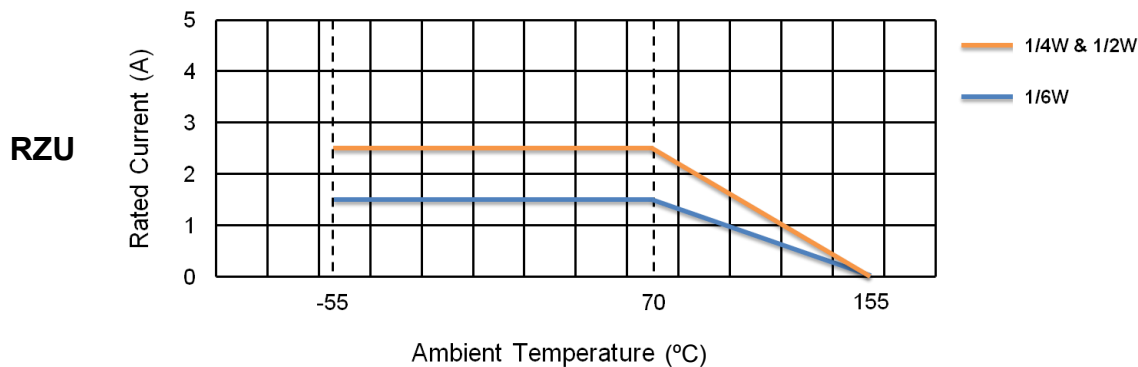

■ 試驗條件與方法 The testing method and condition.

| 試驗項目<br>Test Items                   | 規格值<br>Performance Requirements          | 試驗方法<br>Test Methods and Standard.(JISC5201-1)  |
|--------------------------------------|--|---|
| 電阻值<br>Resistance                    | 規定的誤差值內<br>Within of specified tolerance | 測量點從端蓋 10mm<br>Measuring points are distance 10mm from the end cap(4.5)                     |
| 焊錫效果<br>Solder ability               | After test, <20mΩ                        | Temp. of solder 245°C ± 5°C<br>duration of immersion 5 s ± 0.5 s                            |
| 負荷壽命<br>Load life                    | After test, <20mΩ                        | 額定電流 70°C, 1,000 小時<br>Rated Amperage at 70°C for 1,000 hours                               |
| 耐濕負荷壽命<br>Load life in humidity      | After test, <20mΩ                        | 10% rate power load<br>40°C, 95% RH for 1,000 hours<br>1.5h ON / 0.5h OFF cycle(4.24)       |
| 溫度循環<br>Temperature cycle            | After test, <20mΩ                        | 5 cycles for -25°C (30min) : room temp. (30min)<br>~ +85°C (30min) room temp. (30min)(4.19) |
| 焊錫耐熱<br>Resistance to soldering heat | After test, <20mΩ                        | 260°C ± 5°C for 10 seconds (焊錫槽)<br>350°C ± 10°C for 3.5 seconds (手焊錫)(4.18)                |

# LOW RESISTANCE RESISTOR

## ST 低阻值電阻器 LOW RESISTANCE RESISTOR (ST Type)

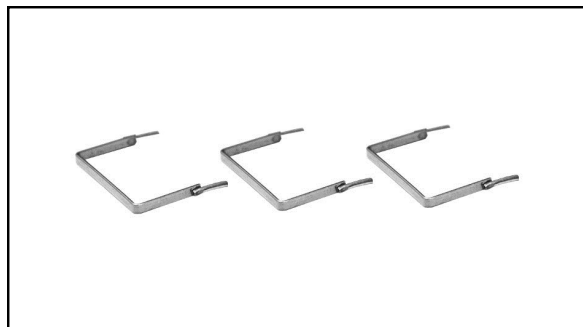

本體顏色 (Body color) :

銀 色 (Silver)

### 結構圖 Construction

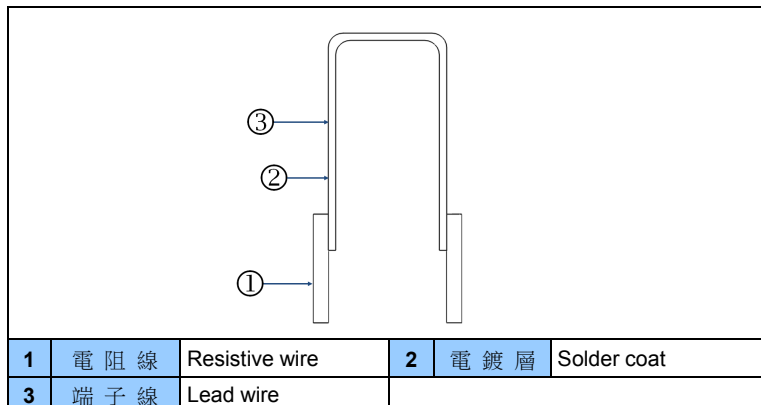

### 特性 Feature

◎尺寸小且重量輕

Small size and light weight.

◎焊錫特性佳

Excellent soldering performance.

◎可依客戶需求製作

Can be produced according to customer's request.

◎產品符合歐盟 RoHS 要求

Products is compliance the EU-RoHS request.

### 料號編碼 Type composition 例 Example

| ST         | 50            | J                | R010                 | MG            | P10          | 10             |
|------------|---------------|------------------|----------------------|---------------|--------------|----------------|
| 型名<br>Type | 溫度係數<br>T.C.R | 誤差值<br>Tolerance | 電阻值(Ω)<br>Resistance | 造型<br>Forming | 端線長<br>Pitch | 線徑<br>Diameter |
|            | 50:±50ppm/°C  | F±1%             | 1M00=1m              | MG            |              |                |
|            | A0:±100ppm/°C | H±3%             | 10M0=10m             |               |              |                |
|            | B0:±200ppm/°C | J±5%             | R100=0.1             |               |              |                |
|            | C0:±300ppm/°C |                  |                      |               |              |                |

### 額定 Ratings

| Ød<br>(mm) | 最大過電流<br>Max. Current Rating (A) | 阻值範圍 Resistance Range (Ω) | 誤差值<br>Tolerance     | 溫度係數<br>T.C.R.                                       | 使用溫度範圍<br>Temperature Range |
|------------|----------------------------------|---------------------------|----------------------|--|-----------------------------|
| 0.8        | 6                                | 1mΩ~ 10 mΩ                | F±1%<br>H±3%<br>J±5% | ± 50ppm/°C<br>±100ppm/°C<br>±200ppm/°C<br>±300ppm/°C | -55°C~150°C                 |
| 1          | 8                                | 10mΩ~ 200 mΩ              |                      |  |                             |
| 1.2        | 10                               | 100mΩ~ 300 mΩ             |                      |  |                             |



■ 額定溫度下降曲線圖 Derating curve

例 Example



■ 試驗條件與方法 The testing method and condition.

| 試驗項目<br>Test Items                   | 規格值<br>Performance Requirements          | 試驗方法<br>Test Methods and Standard.(JISC5201-1)  |
|--------------------------------------|--|---|
| 電阻值<br>Resistance                    | 規定的誤差值內<br>Within of specified tolerance | 測量點從端蓋 10mm<br>Measuring points are distance 10mm from the end cap(4.5)               |
| 溫度係數<br>T.C.R.                       | 規定值內<br>Within of specified T.C.R.       | 室溫+100°C<br>Room temperature +100°C(4.8)  |
| 短時間過負荷<br>Short time overload        | ±2%                                      | No evidence of mechanical damage and after test impedance change ratio                |
| 負荷壽命<br>Load life                    | ±3%                                      | 100% rate power load<br>(90min on and 30min off keep the 1,000 Hrs)                   |
| 耐濕負荷壽命<br>Load life in humidity      | ±2%                                      | 10% rate power load<br>40°C, 95% RH for 1,000 hours<br>1.5h ON / 0.5h OFF cycle(4.24) |
| 焊錫耐熱<br>Resistance to soldering heat | ±1%                                      | 260°C ± 5°C for 10 seconds (焊錫槽)<br>350°C ± 10°C for 3.5 seconds (手焊錫)(4.18)          |
| 可焊性<br>Solderability                 | Coverage 95%                             | Temp. of solder 245°C ± 5°C<br>duration of immersion 5 s ± 0.5 s                      |

# LOW RESISTANCE RESISTOR

LR 低阻值電阻器  
LOW RESISTANCE RESISTOR (LR Type)

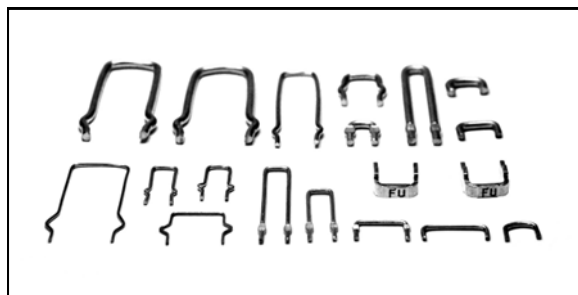

本體顏色 (Body color) :  
銀色 (Silver)

## 特性 Feature

- ◎尺寸小且重量輕  
Small size and light weight.
- ◎焊錫特性佳  
Excellent soldering performance.
- ◎可依客戶需求製作  
Can be produced according to customer's request.
- ◎產品符合歐盟 RoHS 要求  
Products is compliance the EU-RoHS request.

## 結構圖 Construction

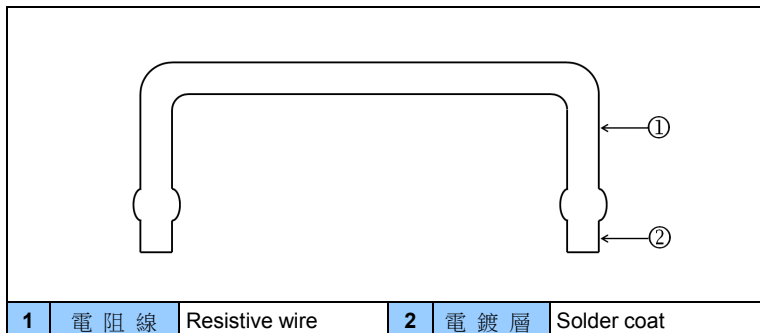

## 料號編碼 Type composition

例 Example

| LR         | MC         | D08               | J                | 2M50                 | L050              |
|------------|------------|-------------------|------------------|----------------------|-------------------|
| 型名<br>Type | 品名<br>Size | 線徑尺寸<br>Wire Size | 誤差值<br>Tolerance | 電阻值(Ω)<br>Resistance | 二次加工<br>Forming   |
|            | MC 錳銅線     | D08:Ø0.8          | F±1%             | 1M00=1m              | See<br>dimensions |
|            | NC 鎳銅線     | D10:Ø1.0          | H±3%             | 10M0=10m             |                   |
|            | NR 鎳鉻線     | D12:Ø1.2          | J±5%             | R100=0.1             |                   |
|            | NH 鍍錫銅線    | D20:Ø2.0          | K±10%            |                      |                   |

## 額定 Ratings

| Ød<br>(mm) | 最大過電流<br>Max. Current Rating (A) | 阻值範圍 Resistance RangeΩ |               | 誤差值<br>Tolerance              | 溫度係數<br>T.C.R.                         | 使用溫度範圍<br>Temperature Range |
|------------|----------------------------------|------------------------|---------------|-------------------------------|--|-----------------------------|
|            |                                  | Copper Manganese       | Copper Nickel |                               |  |                             |
| 0.4        | 2.0                              | 70mΩ~ 200 mΩ           | 80mΩ~ 220 mΩ  | F±1%<br>H±3%<br>J±5%<br>K±10% | ± 50ppm/°C<br>±100ppm/°C<br>±200ppm/°C | -55°C~200°C                 |
| 0.5        | 2.5                              | 50mΩ~ 150 mΩ           | 60mΩ~ 165 mΩ  |                               |  |                             |
| 0.6        | 3.0                              | 50mΩ~ 100 mΩ           | 60mΩ~ 110 mΩ  |                               |  |                             |
| 0.7        | 4.0                              | 30mΩ~ 70 mΩ            | 35mΩ~ 75 mΩ   |                               |  |                             |
| 0.8        | 4.5                              | 20mΩ~ 50 mΩ            | 25mΩ~ 55 mΩ   |                               |  |                             |
| 0.9        | 5.0                              | 20mΩ~ 40 mΩ            | 25mΩ~ 40 mΩ   |                               |  |                             |
| 1          | 5.5                              | 15mΩ~ 30 mΩ            | 20mΩ~ 30 mΩ   |                               |  |                             |
| 1.1        | 6.0                              | 15mΩ~ 20 mΩ            | 16mΩ~ 22 mΩ   |                               |  |                             |

| Ød<br>(mm) | 最大過電流<br>Max. Current Rating (A) | 阻值範圍 Resistance RangeΩ |               | 誤差值<br>Tolerance              | 溫度係數<br>T.C.R.                         | 使用溫度範圍<br>Temperature Range |
|------------|----------------------------------|------------------------|---------------|-------------------------------|--|-----------------------------|
|            |                                  | Copper Manganese       | Copper Nickel |                               |  |                             |
| 1.2        | 7.0                              | 10mΩ~ 20 mΩ            | 12mΩ~ 22 mΩ   | F±1%<br>G±2%<br>J±5%<br>K±10% | ± 50ppm/°C<br>±100ppm/°C<br>±200ppm/°C | -55°C~200°C                 |
| 1.3        | 7.5                              | 10mΩ~ 20 mΩ            | 12mΩ~ 22 mΩ   |                               |  |                             |
| 1.4        | 8.0                              | 10mΩ~ 20 mΩ            | 12mΩ~ 22 mΩ   |                               |  |                             |
| 1.5        | 9.0                              | 10mΩ~ 20 mΩ            | 12mΩ~ 22 mΩ   |                               |  |                             |
| 1.6        | 9.5                              | 10mΩ~ 15 mΩ            | 12mΩ~ 16 mΩ   |                               |  |                             |
| 1.8        | 11.0                             | 5mΩ~ 10 mΩ             | 6mΩ~ 11mΩ     |                               |  |                             |
| 2.0        | 12.0                             | 5mΩ~ 10 mΩ             | 6mΩ~ 11mΩ     |                               |  |                             |
| 2.3        | 14.0                             | 3mΩ~ 5 mΩ              | 3mΩ~ 5 mΩ     |                               |  |                             |

■尺寸 Dimension

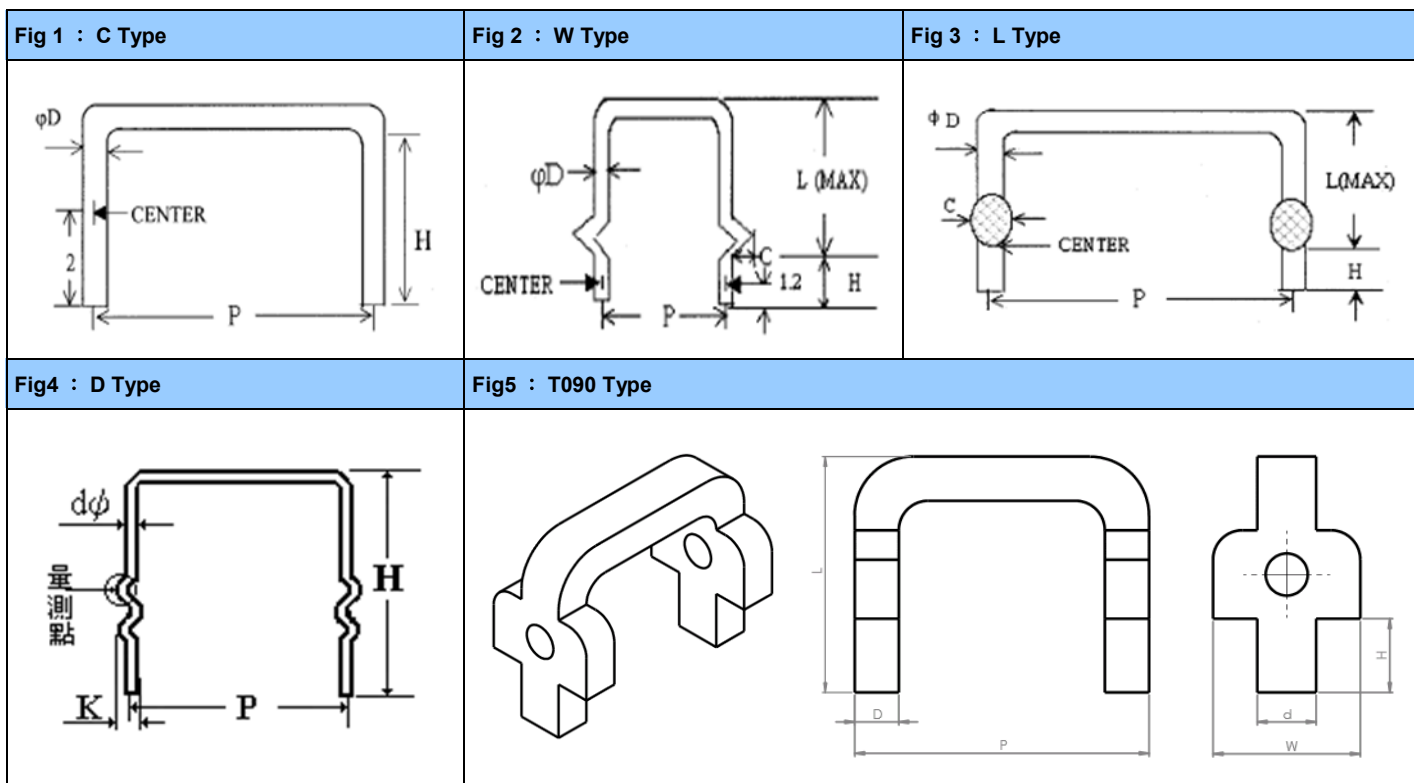

■額定溫度下降曲線圖 Derating curve

例 Example



■試驗條件與方法 The testing method and condition.

| 試驗項目<br>Test Items                   | 規格值<br>Performance Requirements          | 試驗方法<br>Test Methods and Standard.(JISC5201-1)  |
|--------------------------------------|--|---|
| 電阻值<br>Resistance                    | 規定的誤差值內<br>Within of specified tolerance | 測量點從端蓋 10mm<br>Measuring points are distance 10mm from the end cap(4.5)               |
| 溫度係數<br>T.C.R.                       | 規定值內<br>Within of specified T.C.R.       | 室溫+100°C<br>Room temperature +100°C(4.8)  |
| 短時間過負荷<br>Short time overload        | ±(2%)                                    | No evidence of mechanical damage and after test impedance change ratio                |
| 負荷壽命<br>Load life                    | ±(3%)                                    | 100% rate power load<br>(90min on and 30min off keep the 1,000 Hrs)                   |
| 耐濕負荷壽命<br>Load life in humidity      | ±(2%)                                    | 10% rate power load<br>40°C, 95% RH for 1,000 hours<br>1.5h ON / 0.5h OFF cycle(4.24) |
| 焊錫耐熱<br>Resistance to soldering heat | ±(1%)                                    | 260°C ± 5°C for 10 seconds (焊錫槽)<br>350°C ± 10°C for 3.5 seconds (手焊錫)(4.18)          |
| 可焊性<br>Solderability                 | Coverage 95%                             | Temp. of solder 245°C ± 5°C<br>duration of immersion 5 s ± 0.5 s                      |

# POWER CHIP RESISTOR

MR

模造電阻器

POWER CHIP RESISTOR (Standard Type)

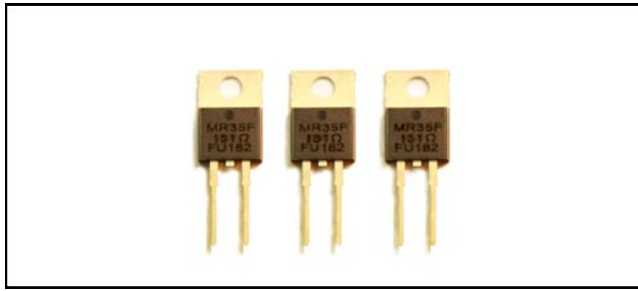

外觀顏色 (Body Color) :

黑色 (Black)

標示 (Marking) :

文字 (Alphanumeric)

## 特性 Feature

◎高穩定性皮膜或金屬板抵抗元素

High stability film or metal plate resistance elements.

◎低感值(<50nH).測試頻率 100K Hz

Low inductive.<50nH). Test frequency 100K Hz.

◎提供 20W,30W,35W,50W

Available in 20W,30W,35W,50W.

◎產品符合歐盟 RoHS 要求

Products is compliance the EU-RoHS request.

## 參考規格 Reference standards

● MIL-STD-202 Method 204

## 料號編碼 Type composition

例 Example

| MR         | Q          | BO                  | J                | 1000                 | S002            | AL                 |
|------------|------------|---------------------|------------------|----------------------|-----------------|--------------------|
| 型名<br>Type | 品名<br>Size | 額定功率<br>Rated power | 誤差值<br>Tolerance | 電阻值(Ω)<br>Resistance | 二次加工<br>Forming | 端腳<br>End Feet     |
|            | Square     | B0:20W              | F±1%             | 0R01=0.01            | 2 Pin           | AL:Aluminum        |
|            | Shape      | C0:30W              | J±5%             | R100=0.1             |                 | NH:copper terminal |
|            |            | C5:35W              |                  | 1R00=1               |                 |                    |
|            |            | E0:50W              |                  | 10R0=10              |                 |                    |
|            |            |                     |                  | 1000=100             |                 |                    |
|            |            |                     |                  | 1001=1K              |                 |                    |
|            |            |                     |                  | 1002=10K             |                 |                    |

## 額定 Ratings

| Type  | Power Rating 1(W) |           | Voltage Rating 4 | Thermal Resistance | 阻值範圍<br>Resistance Range | 誤差值<br>Tolerances | 溫度係數<br>T.C.R. | 包裝 Strip (pcs) |            |
|-------|-------------------|-----------|------------------|--------------------|--------------------------|-------------------|----------------|----------------|------------|
|       | Heatsink2         | Free Air3 |                  |                    |                          |                   |                |                |            |
| MR-20 | 20W               | 2.00W     | 500V             | 5.9°C/ W           | 0.01Ω~ 0.09Ω             | ±5%               | ±200ppm/°C     | 50             |            |
|       |                   |           |                  |                    | 0.1Ω~ 51KΩ               | ±1%、±5%           | ±150ppm/°C     |                |            |
| MR-30 | 30W               | 2.25W     |                  | 4.2°C/ W           | 0.01Ω~ 0.09Ω             | ±5%               | ±200ppm/°C     |                |            |
|       |                   |           |                  |                    | 0.1Ω~ 51KΩ               | ±1%、±5%           | ±150ppm/°C     |                |            |
| MR-35 | 35W               | 2.25W     |                  | 3.3°C/ W           | 3.3°C/ W                 | 0.01Ω~ 0.09Ω      | ±5%            |                | ±200ppm/°C |
|       |                   |           |                  |                    |                          | 0.1Ω~ 51KΩ        | ±1%、±5%        |                | ±150ppm/°C |
| MR-50 | 50W               | 2.50W     |                  | 2.3°C/ W           | 2.3°C/ W                 | 0.01Ω~ 0.09Ω      | ±5%            |                | ±200ppm/°C |
|       |                   |           |                  |                    |                          | 0.1Ω~ 51KΩ        | ±1%、±5%        |                | ±150ppm/°C |

## 結構圖 Construction

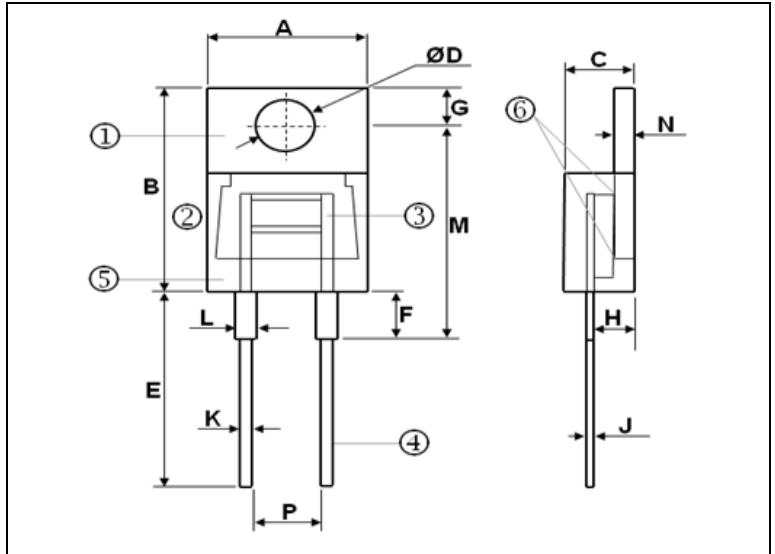

|   |      |               |                              |
|---|------|---------------|------------------------------|
| 1 | 散熱片  | Flange        | Aluminum alloy               |
| 2 | 基板   | Substrate     | Alumina 99%                  |
| 3 | 阻抗材質 | Resistance    | RuO2 or metal plate          |
| 4 | 引線   | Lead terminal | Copper alloy (plated solder) |
| 5 | 壓模樹脂 | Molded resin  | Non-flam ability rubber      |
| 6 | 接點   | Junction part | Welding with high frequency  |

## 外型尺寸 Dimensions (mm)

| Rated Power (W) | 20       | 30 | 35 | 50 |
|-----------------|----------|----|----|----|
| A               | 10.1±0.2 |    |    |    |
| B               | 15±0.2   |    |    |    |
| C               | 4.5±0.2  |    |    |    |
| ØD              | 3.6±0.1  |    |    |    |
| E               | 14.5±1.0 |    |    |    |
| F               | 4±0.5    |    |    |    |
| G               | 3±0.2    |    |    |    |
| H               | 2.75±0.2 |    |    |    |
| J               | 0.5±0.1  |    |    |    |
| K               | 0.75±0.1 |    |    |    |
| L               | 1.4±0.1  |    |    |    |
| M               | 16±0.1   |    |    |    |
| N               | 1.3±0.1  |    |    |    |
| P               | 5.08±0.1 |    |    |    |

■ 額定溫度下降曲線圖 Derating curve

例 Example

< 30W



> 30W



■ 試驗條件與方法 The testing method and condition.

| 試驗項目<br>Test Items                     | 規格值<br>Performance Requirements                                  | 試驗方法<br>Test Methods and Standard.(JISC5201-1)  |
|--|--|---|
| 電阻值<br>Resistance                      | 規定的誤差值內<br>Within of specified tolerance                         | 測量點從端蓋 10mm<br>Measuring points are distance 10mm from the end cap(4.5)               |
| 溫度係數<br>T.C.R.                         | 規定值內<br>Within of specified T.C.R.                               | 室溫+100°C<br>Room temperature +100°C(4.8)  |
| 熱衝擊<br>Thermal Shock                   | ±0.3%  | Test temp. -55°C ~ +85°C<br>Number of 5 cycles  |
| 負荷壽命<br>Load life                      | ±1%  | Rated voltage at 70°C for 1,000 hours<br>1.5hr ON / 0.5hr OFF Cycles(4.25.1)          |
| 耐濕負荷壽命<br>Load life in humidity        | ±5%  | 10% rate power load<br>40°C, 95% RH for 1,000 hours<br>1.5h ON / 0.5h OFF cycle(4.24) |
| 耐濕性<br>Moisture resistance             | ±1%  | 65°C, 90~95% RH, 240 小時<br>65°C, 90~95% RH for 240 hours                              |
| 焊錫耐熱<br>Resistance to soldering heat   | ±0.25%   | Temp. of solder 350°C ± 5°C<br>duration of immersion 3.5 s ± 0.5 s                    |
| 焊錫效果<br>Solder ability                 | 95 % (min) coverage  | Temp. of solder 245°C ± 5°C<br>duration of immersion 3 s ± 0.5 s                      |
| 耐電壓<br>Dielectric withstanding voltage | Flash over, burning, insulation damage<br>Should not be observed | V-Block test voltage : DC 2,200V<br>Duration time 60 sec.                             |
| 絕緣電阻<br>Insulation resistance          | >1,000MΩ   | 500V 絕緣測試 1 分鐘<br>500V insulation test 1min.(4.6.1)                                   |
| 振動試驗<br>Vibration                      | ±(0.25 % + 0.05Ω)  | MIL-STD-202 Method 204 Condition D.   |

# APPENDIX (Forming)

| Forming Style | Forming Type Name        |            | Dimensions (mm) |         |         |          |
|---------------|--------------------------|------------|-----------------|---------|---------|----------|
|               | Rated Power (W)          | Type Name  | P               | H       | h       | Ød       |
|               | 1/4,S1/2,P1              | L10(*12.5) | 10±1            | 5.5±1.5 | 4.0±0.5 | 0.6±0.05 |
|               | 1/2,S1,P2 <sup>(1)</sup> | L12.5(*15) | 12.5±2          | 4.5±1   | 4.0±0.5 | 0.6±0.05 |
|               | 1,S2,P3                  | L15        | 15±2            | 6±1.5   | 4.0±0.5 | 0.8±0.05 |
|               | 2,S3,P5                  | L20        | 20±2            | 10±2    | 4.0±0.5 | 0.8±0.05 |
|               | 3W,S5                    | L30        | 30±2            | 10±2    | 4.0±0.5 | 0.8±0.05 |
|               | 1/4,S1/2,P1              | C10(*12.5) | 10±1            | 5.0±0.5 | ---     | 0.6±0.05 |
|               | 1/2,S1,P2 <sup>(1)</sup> | C12.5(*15) | 12.5±2          | 5.0±0.5 | ---     | 0.6±0.05 |
|               | 1,S2,P3                  | C15        | 15±2            | 5.0±0.5 | ---     | 0.8±0.05 |
|               | 2,S3,P5                  | C20        | 20±2            | 5.0±0.5 | ---     | 0.8±0.05 |
|               | 3W,S5                    | C30        | 30±2            | 5.0±0.5 | ---     | 0.8±0.05 |
|               | 1/4,S1/2,P1              | ---        | ---             | ---     | ---     | ---      |
|               | 1/2,S1,P2 <sup>(1)</sup> | FA5        | 5±1             | 5.0±1.0 | 4.0±0.5 | 0.6±0.05 |
|               | 1,S2,P3                  | FA5        | 7±2             | 5.0±1.0 | 4.0±0.5 | 0.8±0.05 |
|               | 2,S3,P5                  | FA5        | 8±2             | 5.0±1.0 | 4.0±0.5 | 0.8±0.05 |
|               | 3W,S5                    | ---        | ---             | ---     | ---     | ---      |
|               | 1/4,S1/2,P1              | FB5        | 5±1             | 5.0±1.0 | 4.0±0.5 | 0.6±0.05 |
|               | 1/2,S1,P2 <sup>(1)</sup> | FB5        | 5±1             | 5.0±1.0 | 4.0±0.5 | 0.6±0.05 |
|               | 1,S2,P3                  | FB5        | 6±2             | 5.0±1.0 | 4.0±0.5 | 0.8±0.05 |
|               | 2,S3,P5                  | FB5        | 8±2             | 5.0±1.0 | 4.0±0.5 | 0.8±0.05 |
|               | 3W,S5                    | ---        | ---             | ---     | ---     | ---      |
|               | 1/4,S1/2,P1              | ---        | ---             | ---     | ---     | ---      |
|               | 1/2,S1,P2 <sup>(1)</sup> | FC5        | 5±1             | 5.0±1.0 | 4.0±1.0 | 0.6±0.05 |
|               | 1,S2,P3                  | FC5        | 6±2             | 5.0±1.0 | 4.0±1.0 | 0.8±0.05 |
|               | 2,S3,P5                  | FC5        | 6±2             | 5.0±1.0 | 4.0±1.0 | 0.8±0.05 |
|               | 3W,S5                    | ---        | ---             | ---     | ---     | ---      |
|               | 1/4,S1/2,P1              | ---        | ---             | ---     | ---     | ---      |
|               | 1/2,S1,P2 <sup>(1)</sup> | FD5        | 5(REF)          | 3.3±0.5 | ---     | 0.6±0.05 |
|               | 1,S2,P3                  | FD5        | 5(REF)          | 3.3±0.5 | ---     | 0.8±0.05 |
|               | 2,S3,P5                  | FD5        | 5(REF)          | 3.3±0.5 | ---     | 0.8±0.05 |
|               | 3W,S5                    | ---        | ---             | ---     | ---     | ---      |
|               | 1/4,S1/2,P1              | M10        | 10±1            | 5.0±1.0 | 4.5±0.5 | 0.6±0.05 |
|               | 1/2,S1,P2 <sup>(1)</sup> | M12.5      | 12.5±1          | 8.0±1.0 | 4.5±0.5 | 0.6±0.05 |
|               | 1,S2,P3                  | M15        | 15±1.5          | 6.5±0.5 | 3.0±0.5 | 0.8±0.05 |
|               | 2,S3,P5                  | M20        | 20±2.0          | 6.5±0.5 | 3.0±0.5 | 0.8±0.05 |
|               | 3W,S5                    | M30        | 30±2.0          | 6.5±0.5 | 3.0±0.5 | 0.8±0.05 |

(1) wirewound Type is 0.7mm of terminal size

\* forming pitch request please contact sales.

| Forming Style     | Forming Type Name        |           | Dimensions (mm) |          |           |          |
|-------------------|--------------------------|-----------|-----------------|----------|-----------|----------|
|                   | Rated Power (W)          | Type Name | P               | b1       | b2        | Ød       |
| <b>D Type</b><br> | 1/4,S1/2,P1              | ---       | ---             | ---      | ---       | ---      |
|                   | 1/2,S1,P2 <sup>(1)</sup> | D12.5*    | 12.5±2          | 1.1±0.25 | 1.45±0.25 | 0.6±0.05 |
|                   | 1,S2,P3                  | D15       | 15±2            | 1.3±0.25 | 1.65±0.25 | 0.8±0.05 |
|                   | 2,S3,P5                  | D20       | 20±2.0          | 1.3±0.25 | 1.65±0.25 | 0.8±0.05 |
|                   | 3W,S5                    | D30       | 30±2.0          | 1.3±0.25 | 1.65±0.25 | 0.8±0.05 |

| Forming Style     | Forming Type Name        |           | Dimensions (mm) |     |         |          |
|-------------------|--------------------------|-----------|-----------------|-----|---------|----------|
|                   | Rated Power (W)          | Type Name | P               | H   | h       | Ød       |
| <b>Y Type</b><br> | 1/4,S1/2,P1              | ---       | ---             | --- | ---     | ---      |
|                   | 1/2,S1,P2 <sup>(1)</sup> | y14       | 14Max           | 7±1 | 5.0±0.5 | 0.8±0.05 |
|                   | 1,S2,P3                  | y17       | 17Max           | 8±1 | 5.0±0.5 | 0.8±0.05 |
|                   | 2,S3,P5                  | y21       | 21Max           | 9±1 | 5.0±0.5 | 0.8±0.05 |
|                   | 3W,S5                    | ---       | ---             | --- | ---     | ---      |

| Forming Style      | Forming Type Name |           | Dimensions (mm) |     |       |          |
|--------------------|-------------------|-----------|-----------------|-----|-------|----------|
|                    | Rated Power (W)   | Type Name | P               | H   | P1    | Ød       |
| <b>YT Type</b><br> | 1/4,S1/2,P1       | ---       | ---             | --- | ---   | ---      |
|                    | 1/2,S1,P2         | YT        | 14Max           | 7±1 | 7.5±1 | 0.8±0.05 |
|                    | 1,S2,P3           | YT        | 17Max           | 8±1 | 7.5±1 | 0.8±0.05 |
|                    | 2,S3,P5           | YT        | 21Max           | 9±1 | 7.5±1 | 0.8±0.05 |
|                    | 3W,S5             | ---       | ---             | --- | ---   | ---      |

| Forming Style | Mark               |         | Size     |               | Mark |         | Size      |                  | Mark |     | Size             |          |
|---------------|--------------------|---------|----------|---------------|------|---------|-----------|------------------|------|-----|------------------|----------|
|               | <b>FT Type</b><br> | P       |          | 12.7±1.0      |      | W       |           | 18.0±1.0         |      | W2  |                  | 3(Max)   |
| P0            |                    |         | 12.7±0.3 |               | H0   |         | 16.5±0.5  |                  | w0   |     | 5(Max)           |          |
| P1            |                    |         | 3.85±0.7 |               | D0   |         | 4.0±0.2   |                  | W1   |     | 9±0.5            |          |
| P2            |                    |         | 1.7*5.2  | 6.35±1        | A 0  |         | 1.7*5.2   | 13(Max)          | Ød   |     |                  | 0.6±0.05 |
|               |                    |         | 2*8      |               |      |         | 16.5(Max) |                  |      |     |                  | 0.6±0.05 |
| P3            |                    | 3.35*10 | 5.5±1    |               |      | 3.35*10 | 19(Max)   |                  |      |     | 0.8±0.05         |          |
|               |                    |         |          |               |      |         |           |                  |      |     |                  |          |
|               |                    | P3      |          | 5.08+0.6,-0.2 |      | △ g     |           | 0±3 <sup>0</sup> |      | △ h | 0±2 <sup>0</sup> |          |

| Forming Style     | Forming Type Name |           | Dimensions (mm) |        |      |          |
|-------------------|-------------------|-----------|-----------------|--------|------|----------|
|                   | Rated Power (W)   | Type Name | W               | P      | L1   | Ød       |
| <b>Taping</b><br> | 1/4,S1/2,P1       | A52       | 52±1            | 5±0.5  | 21.5 | 0.6±0.05 |
|                   | 1/2,S1,P2         | A52       | 52±1            | 5±0.5  | 21.5 | 0.6±0.05 |
|                   | 1,S2,P3           | A52       | 52±1            | 5±0.5  | 21.5 | 0.8±0.05 |
|                   | 2,S3,P5           | A64       | 63±1            | 10±0.5 | 23.5 | 0.8±0.05 |
|                   | 3W,S5             | A73       | 73±1            | 10±0.5 | 24.5 | 0.8±0.05 |

# APPENDIX (RG series Type Forming)

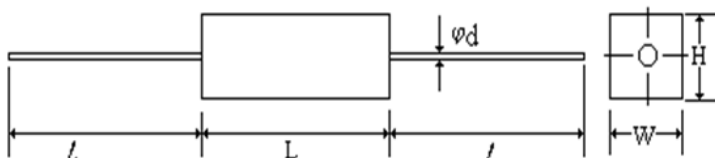
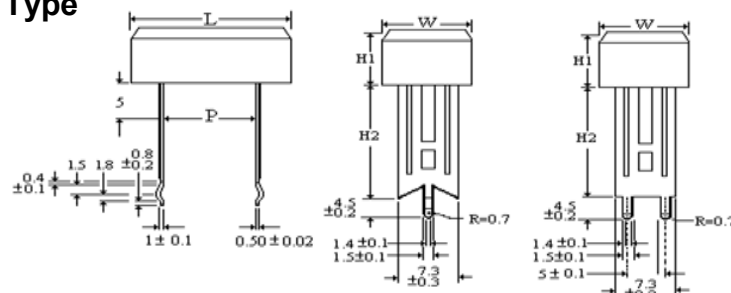
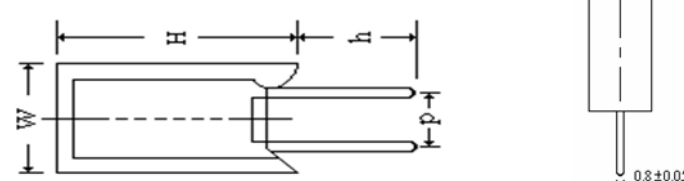
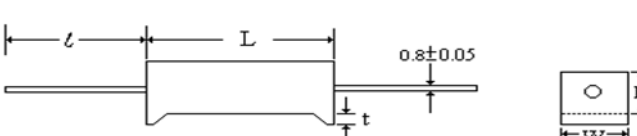
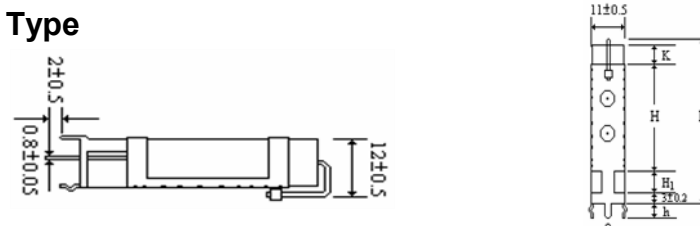
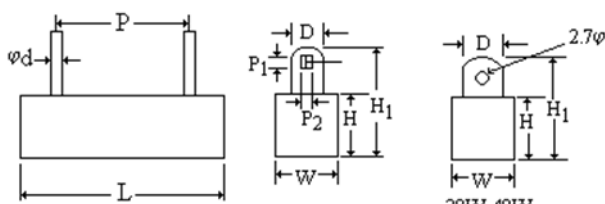
| Forming Style  | Rated Power (W) | Dimensions (mm) |        |        |               |          |         |         |         |
|--|-----------------|-----------------|--------|--------|---------------|----------|---------|---------|---------|
|  |                 | L               | W      | H      | ℓ             | ∅d       |         |         |         |
| <b>P Type</b><br>   | 1               | 14±1            | 6.5±1  | 6.5±1  | 23±3          | 0.6±0.05 |         |         |         |
|  | 2               | 18±1            | 7±1    | 7±1    | 23±3          | 0.6±0.05 |         |         |         |
|  | 3               | 22±1.5          | 8±1    | 8±1    | 33±3          | 0.8±0.05 |         |         |         |
|  | 5               | 22±1.5          | 10±1   | 9±1    | 33±3          | 0.8±0.05 |         |         |         |
|  | 7               | 35±1.5          | 10±1   | 9±1    | 33±3          | 0.8±0.05 |         |         |         |
|  | 10              | 48±1.5          | 10±1   | 9±1    | 30±3          | 0.8±0.05 |         |         |         |
|  | 15              | 48±1.5          | 12.5±1 | 11.5±1 | 30±3          | 0.8±0.05 |         |         |         |
|  | 20~25           | 60±2            | 14±1   | 13.5±1 | 33±3          | 0.8±0.05 |         |         |         |
| <b>Z Type</b><br>   | Rated Power (W) | W               | L      | H1     | H2            | P        |         |         |         |
|  | 3               | 10±1            | 25±1.5 | 10±1   | 10.5±1<br>(2) | 9±1.5    |         |         |         |
|  | 5               | 10±1            | 28±1.5 | 10±1   |               | 15±1.5   |         |         |         |
|  | 7               | 10±1            | 36±1.5 | 10±1   |               | 20±1.5   |         |         |         |
|  | 10              | 10±1            | 48±1.5 | 10±1   |               | 32±1.5   |         |         |         |
|  | 15              | 12.5±1          | 48±1.5 | 12±1   |               | 32±1.5   |         |         |         |
| 20~25  | 12.5±1          | 62.5±1          | 13±1   | 15±1   | 42±1.5        |          |         |         |         |
| <b>M Type</b><br> | Rated Power (W) | P               | W      | H      | h             | S        |         |         |         |
|  | 2               | 5±1             | 11±1   | 20±1.5 | 3.5±1         | 7±1      |         |         |         |
|  | 3               | 5±1             | 12±1   | 25±1.5 | 3.5±1         | 8±1      |         |         |         |
|  | 5               | 5±1             | 13±1   | 25±1.5 | 3.5±1         | 9±1      |         |         |         |
|  | 7               | 5±1             | 13±1   | 39±1.5 | 3.5±1         | 9±1      |         |         |         |
|  | 10              | 5±1             | 13±1   | 51±1.5 | 3.5±1         | 9±1      |         |         |         |
|  | 10S             | 7.5±1           | 16±1   | 35±1.5 | 3.5±1         | 12±1     |         |         |         |
| 20   | 8±1             | 20±1            | 45±1   | 3.5±1  | 13±1.5        |          |         |         |         |
| <b>T Type</b><br> | Rated Power (W) | L               | W      | H      | ℓ             | t        |         |         |         |
|  | 5               | 22±1.5          | 10±1   | 9±1    | 33±3          | 1.5±0.5  |         |         |         |
|  | 7               | 35±1.5          | 10±1   | 9±1    | 33±3          | 3.0±0.5  |         |         |         |
|  | 10              | 48±1.5          | 10±1   | 9±1    | 30±3          | 3.0±0.5  |         |         |         |
| <b>S Type</b><br> | Rated Power (W) | L               | H      | H1     | K             | h        |         |         |         |
|  | 7               | 46±1.5          | 28±0.5 | 7±0.5  | 6.5±0.5       | 4±0.3    |         |         |         |
| 10   | 60±1.5          | 28±0.5          | 7±0.5  | 20±0.5 | 4±0.3         |          |         |         |         |
| <b>H Type</b><br>  | Rated Power (W) | W               | H      | L      | P             | H1       | D       | P1      | P2      |
|  | 10              | 10±1            | 10±1   | 48±1.5 | 32±1          | 18±1     | 5±0.5   | 2.5±0.2 | 1.7±0.2 |
|  | 15              | 12.5±1          | 11.5±1 | 48±1.5 | 32±1          | 21±1     | 5±0.5   | 2.5±0.2 | 1.7±0.2 |
|  | 20              | 12.5±1          | 12.5±1 | 62±1.5 | 42±1          | 24±1     | 6±0.5   | 3±0.2   | 2.5±0.2 |
|  | 30              | 19±1            | 19±1   | 75±1.5 | 55±2          | 31±1     | 7.5±0.5 | -----   | -----   |
|  | 40              | 19±1            | 19±1   | 90±1.5 | 67±2          | 31±1     | 7.5±0.5 | -----   | -----   |
| (3)  |                 |                 |        |        |               |          |         |         |         |

(2) the terminal length has 10.5 and 25mm choose for client

(3) difference terminal Type please contact sales



# APPENDIX (Resistance Tolerance / Basic Value E24 & E96)

## ■電阻值公差 Resistance tolerance

| 記號<br>Symbol                 | V        | L       | U       | A       | B       | C       | D       | F    | G    | J    | K     | M     |
|------------------------------|----------|---------|---------|---------|---------|---------|---------|------|------|------|-------|-------|
| 阻值誤差<br>Resistance tolerance | ± 0.005% | ± 0.01% | ± 0.02% | ± 0.05% | ± 0.10% | ± 0.25% | ± 0.50% | ± 1% | ± 2% | ± 5% | ± 10% | ± 20% |

## ■電阻值有效數字 Significant figures of Nominal resistance

| E12 | E24 | E96 |     |     |     |
|-----|-----|-----|-----|-----|-----|
| 10  | 10  | 100 | 178 | 316 | 562 |
|     | 11  | 102 | 182 | 324 | 576 |
| 12  | 12  | 105 | 187 | 332 | 590 |
|     | 13  | 107 | 191 | 340 | 604 |
| 15  | 15  | 110 | 196 | 348 | 619 |
|     | 16  | 113 | 200 | 357 | 634 |
| 18  | 18  | 115 | 205 | 365 | 649 |
|     | 20  | 118 | 210 | 374 | 665 |
| 22  | 22  | 121 | 215 | 383 | 681 |
|     | 24  | 124 | 221 | 392 | 698 |
| 27  | 27  | 127 | 226 | 402 | 715 |
|     | 30  | 130 | 232 | 412 | 732 |
| 33  | 33  | 133 | 237 | 422 | 750 |
|     | 36  | 137 | 243 | 432 | 768 |
| 39  | 39  | 140 | 249 | 442 | 787 |
|     | 43  | 143 | 255 | 453 | 806 |
| 47  | 47  | 147 | 261 | 464 | 825 |
|     | 51  | 150 | 267 | 475 | 845 |
| 56  | 56  | 154 | 274 | 487 | 866 |
|     | 62  | 158 | 280 | 499 | 887 |
| 68  | 68  | 162 | 287 | 511 | 909 |
|     | 75  | 165 | 294 | 523 | 931 |
| 82  | 82  | 169 | 301 | 536 | 953 |
|     | 91  | 174 | 309 | 549 | 976 |

## ■電阻值&公差表示 Color code for discrete resistors

E12, E24

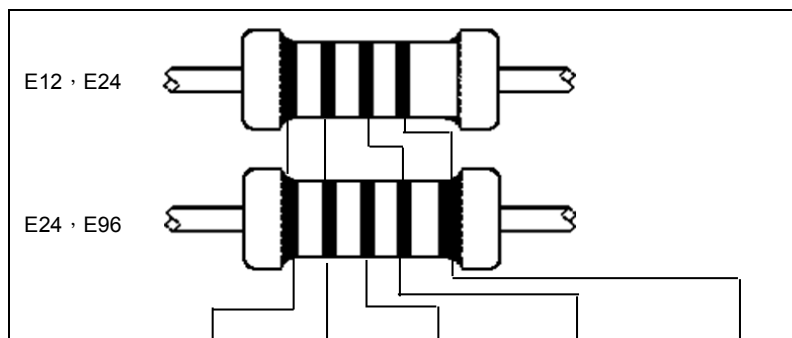

E24, E96



| 顏色<br>Color | 第一色碼<br>1st Figure | 第二色碼<br>2nd Figure | 第三色碼<br>3rd Figure | 倍率<br>Multiplier | 阻值誤差<br>Tolerance |
|-------------|--------------------|--------------------|--------------------|------------------|-------------------|
| 黑 : Black   | 0                  | 0                  | 0                  | 1                | L : ± 0.01%       |
| 棕 : Brown   | 1                  | 1                  | 1                  | 10               | F : ± 1%          |
| 紅 : Red     | 2                  | 2                  | 2                  | 100              | G : ± 2%          |
| 橙 : Orange  | 3                  | 3                  | 3                  | 1,000            | U : ± 0.02%       |
| 黃 : Yellow  | 4                  | 4                  | 4                  | 10,000           | V : ± 0.005%      |
| 綠 : Green   | 5                  | 5                  | 5                  | 100,000          | D : ± 0.5%        |
| 藍 : Blue    | 6                  | 6                  | 6                  | 1,000,000        | C : ± 0.25%       |
| 紫 : Purple  | 7                  | 7                  | 7                  | 10,000,000       | B : ± 0.1%        |
| 灰 : Gray    | 8                  | 8                  | 8                  | ---              | A : ± 0.05%       |
| 白 : White   | 9                  | 9                  | 9                  | ---              | ---               |
| 金 : Gold    | ---                | ---                | ---                | 0.1              | J : ± 5%          |
| 銀 : Silver  | ---                | ---                | ---                | 0.01             | K : ± 10%         |
| 無 : Plain   | ---                | ---                | ---                | ---              | M : ± 20%         |

# Resistor loading calculation and Surge test method

## 1. Energy calculation for single pulse

a. Capacitor Energy of RC circuit:

$$E = \frac{1}{2} \times C \times V^2 \quad (C: \text{Capacitance} \cdot V: \text{Voltage})$$

b. For triangle wave

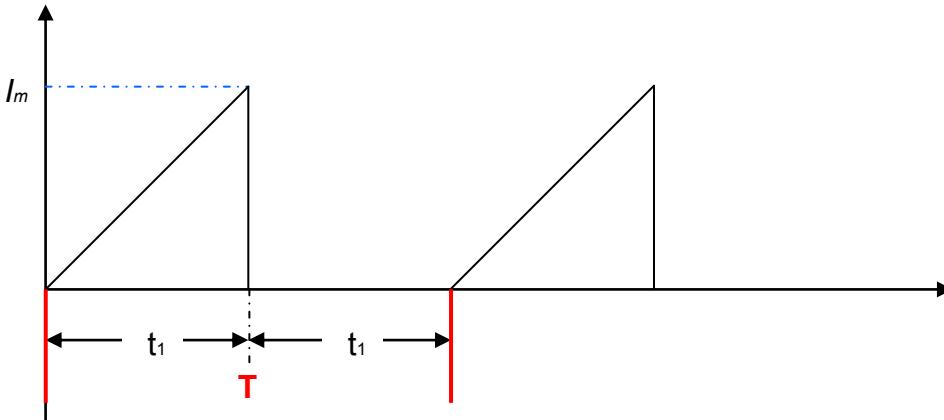

$$f(t) = \frac{I_m}{t_1} (t - t_1) + I_m \quad \text{When } 0 \leq t \leq t_1$$

$$f(t) = 0 \quad \text{When } t_1 < t < T$$

$$I_{RMS} = \sqrt{\frac{1}{2t_1} \int_0^{2t_1} [2f(t)]^2 dt} = \frac{I_m}{\sqrt{6}}$$

$$E = I_{RMS}^2 \times R \times T \quad (I_{RMS}: \text{Root Mean Square current} \cdot T: \text{Loading period} \cdot R: \text{Resistance})$$

Here is the other sample for triangle wave energy calculation.

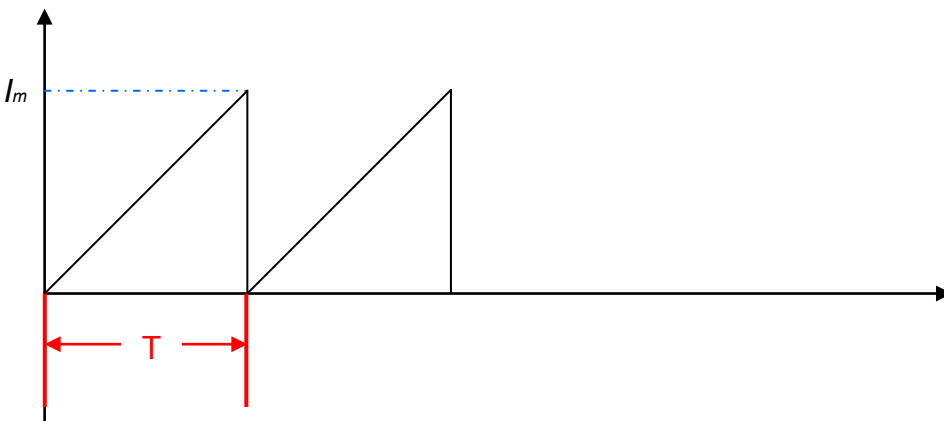

$$f(t) = \frac{I_m}{T} (t - T) + I_m$$

$$I_{RMS} = \sqrt{\frac{1}{T} \int_0^T [f(t)]^2 dt} = \frac{I_m}{\sqrt{3}}$$

$$E = I_{RMS}^2 \times R \times T \quad (I_{RMS}: \text{Root Mean Square current} \cdot T: \text{Loading period} \cdot R: \text{Resistance})$$

c. For sine wave

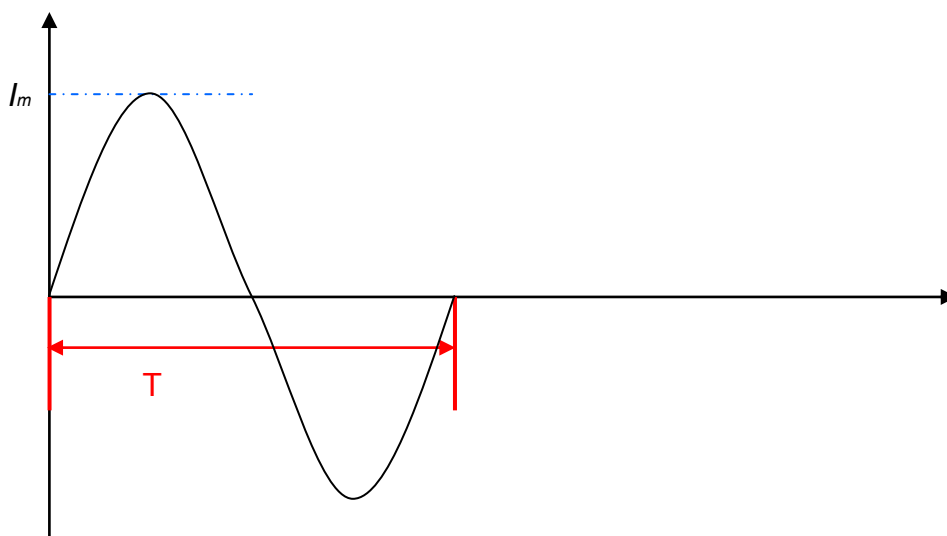

$$f(t) = I_m \sin(t)$$

$$I_{RMS} = \sqrt{\frac{1}{T} \int_0^T [f(t)]^2 dt} = \frac{I_m}{\sqrt{2}}$$

$$E = I_{RMS}^2 \times R \times T \quad (I_{RMS}: \text{Root Mean Square current} \cdot T: \text{Loading period} \cdot R: \text{Resistance})$$

d. For rectangle wave

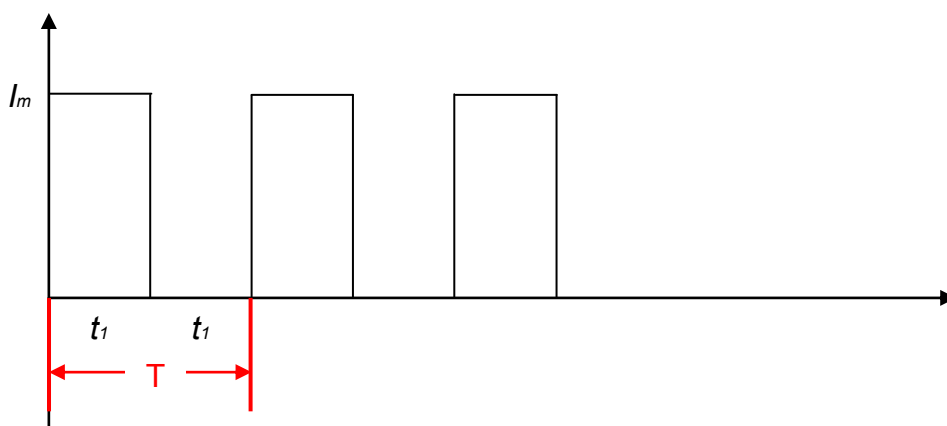

$$f(t) = I_m \quad \text{When } 0 \leq t \leq t_1$$

$$I_{RMS} = \sqrt{\frac{1}{T} \int_0^T [f(t)]^2 dt} = \frac{I_m}{\sqrt{2}}$$

$$E = I_{RMS}^2 \times R \times T \quad (I_{RMS}: \text{Root Mean Square current} \cdot T: \text{Loading period} \cdot R: \text{Resistance})$$

2. Power rate

$$W = \frac{E}{t}$$

# Resistor loading calculation and Surge test method

3. Temperature effect: (Follow statement is the example, real de-rating curve and surge curve should follow the spec.)



Figure 1

According Figure 1, the ambient temperature will affect the loading ability. The temperature factor can be presented as:

$$\tau_t = \frac{155 - 25}{155 - T} \quad (T: \text{Application ambient temperature})$$

4. Loading ratio:

a. For continues loading:

$$\text{Ratio} = \frac{W}{W_{Rate}} \times \tau_t \times 100\% \quad (W_{Rate}: \text{Rated power})$$

b. For impulse loading:

First we need to multiply temperature factor to get the modified power rate.

$$W_m = W \times \tau_t \quad (W_m: \text{Modified power rate})$$

After we got  $W_m$ , we can find out the capability loading time on Figure 2.

$$\text{Ratio} = \frac{t}{t_c} \times 100\% \quad (t_c: \text{Capability loading time})$$

5. Judgment method

Because of the ambient temperature variation would affect the resistor loading ability; therefore we would recommend the loading ratio should smaller than 80%.

## 6. Surge test circuit

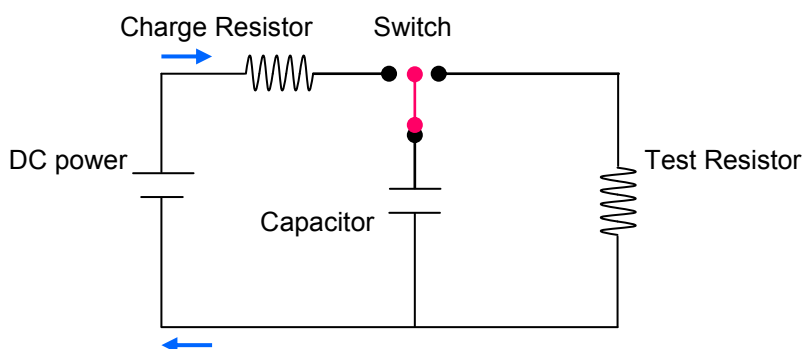

Test method should follow the JISC5201 standard. After 10000 cycle test, the resistor can not show any damage and resistance variation shall smaller than 5%.

Figure 2

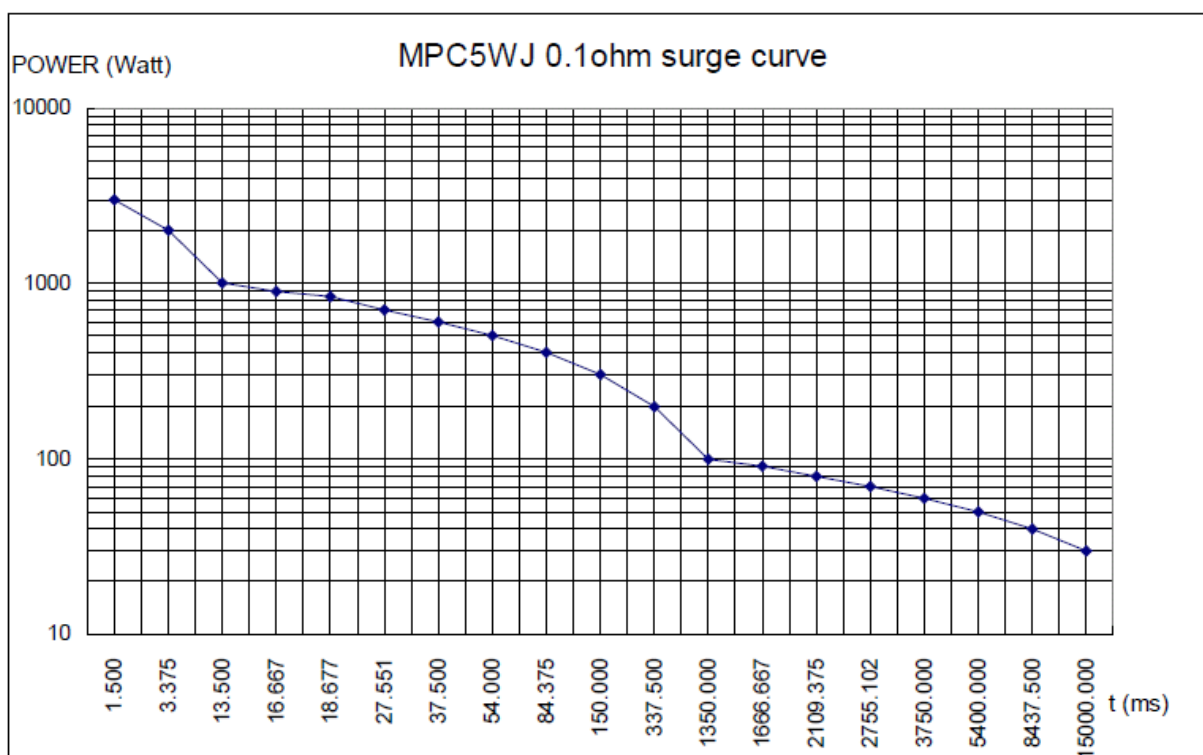

## NOTE

---

---



## X-ON Electronics

Largest Supplier of Electrical and Electronic Components

*Click to view similar products for [Wirewound Resistors - Chassis Mount](#) category:*

*Click to view products by [Futaba](#) manufacturer:*

Other Similar products are found below :

[RER50F18R7RC02](#) [RER50F7R50RC02](#) [RER70F9R80RC02](#) [RER75F4991MC02](#) [RH0055R000FC02W09](#) [2-1623821-6](#)  
[RBSA20008R800KGBLT](#) [RER60F34R8RC02](#) [RER65F1R50PC02](#) [RER70F62R5PC02](#) [VK100NA-200](#) [VK100NA-50](#) [VK100NA-750](#)  
[40/70MJ2K00BE](#) [VP10FA-3K](#) [VP50KA-20K](#) [VPR10F-13.5K](#) [VPR10F-4.5K](#) [VPR10F-700](#) [VPR10F-7.5K](#) [VPR20H150](#) [VPR5F-22.5K](#)  
[VRH320](#) [3K3](#) [K](#) [RER75F1R00RC02](#) [RER70F27R4P](#) [VPR5F-600](#) [VPR5F250](#) [VPR10F-8K](#) [VPR10F-6K](#) [VPR10F225](#) [VPR10F-1.75K](#)  
[VPR10F-1.25K](#) [VPR10F-125](#) [VPR10F10](#) [VP50KA-12K](#) [VP50KA-100K](#) [VP25KA-5000](#) [VK100NA250](#) [VK100NA-15](#) [620-5R00-FBW](#)  
[850J5R0E-B](#) [L100J150E-MT1](#) [L50J500E-MT1](#) [VPR10F-8.5K](#) [VPR10F-0.4](#) [SL130J100K-12](#) [VPR10F-12.5K](#) [F30J20R](#) [HSC1008R0F](#)  
[CL65J10R](#)