

FEATURE

- High voltage
- Large continuous collector current capability

MARKING: 1013

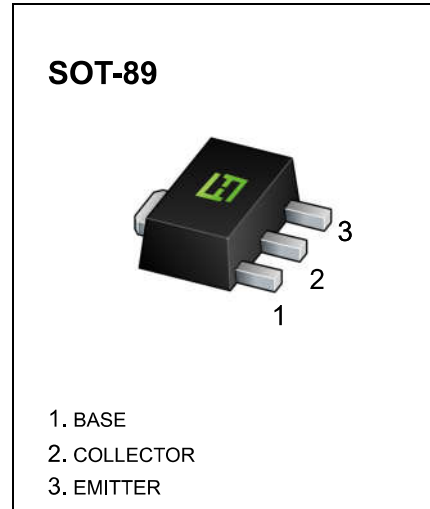

MAXIMUM RATINGS (T_a=25°C unless otherwise noted)

Symbol	Parameter	Value	Unit
V _{CB0}	Collector-Base Voltage	-160	V
V _{CEO}	Collector-Emitter Voltage	-160	V
V _{EBO}	Emitter-Base Voltage	-6	V
I _C	Collector Current -Continuous	-1	A
P _C	Collector Power Dissipation	0.5	W
T _J , T _{stg}	Operation Junction and Storage Temperature Range	-55~+150	°C
R _{θJA}	Thermal Resistance from Junction to Ambient	250	°C/W

ELECTRICAL CHARACTERISTICS (T_a=25°C unless otherwise specified)

Parameter	Symbol	Test conditions	Min	Max	Unit
Collector-base breakdown voltage	V _{(BR)CBO}	I _C =- 100μA , I _E =0	-160		V
Collector-emitter breakdown voltage	V _{(BR)CEO}	I _C = -1mA , I _B =0	-160		V
Emitter-base breakdown voltage	V _{(BR)EBO}	I _E = -10μA , I _C =0	-6		V
Collector cut-off current	I _{CBO}	V _{CB} =-150 V , I _E =0		-1	μA
Emitter cut-off current	I _{EBO}	V _{EB} =-6V, I _C =0		-1	μA
DC current gain	h _{FE}	V _{CE} =-5 V , I _C =- 200mA	60	320	
Collector-emitter saturation voltage	V _{CE(sat)}	I _C = -500m A , I _B = -50mA		-1.5	V
Base-emitter voltage	V _{BE}	I _C = -5 mA , V _{CE} =- 5V		-0.75	V
Transition frequency	f _T	V _{CE} = -5 V , I _C = -200mA	15		MHz

CLASSIFICATION OF h_{FE}

Rank	R	O	Y
Range	60-120	100-200	160-320

Typical Characteristics

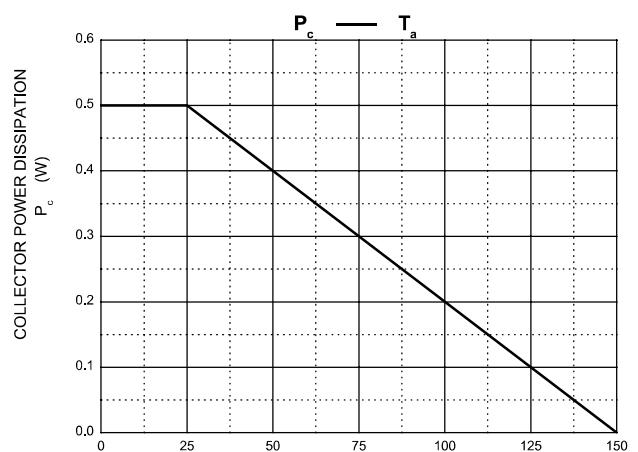
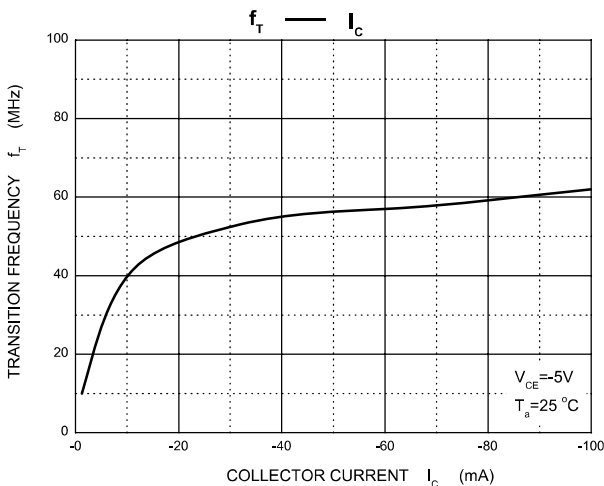
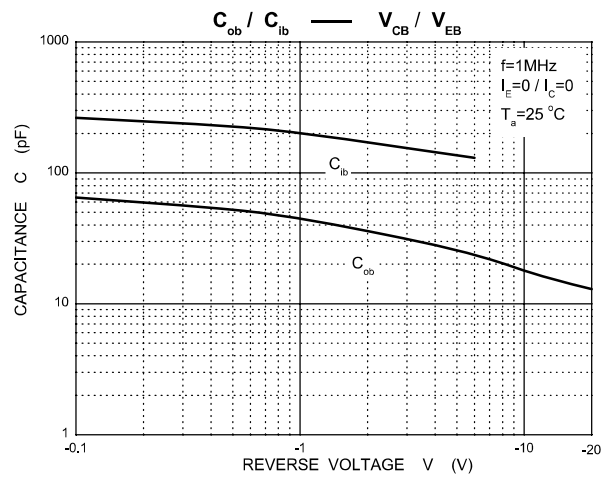
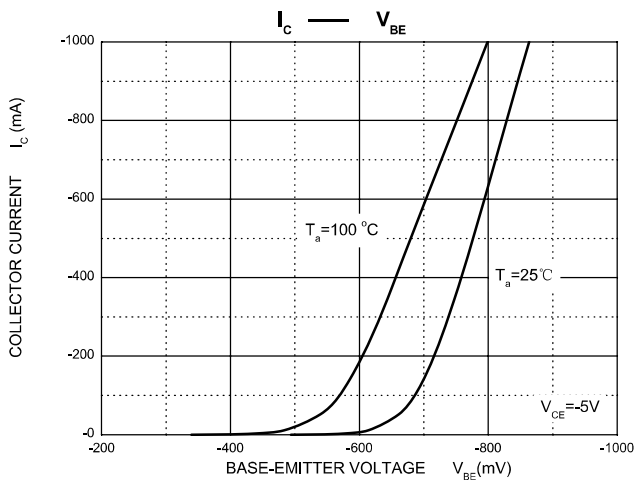
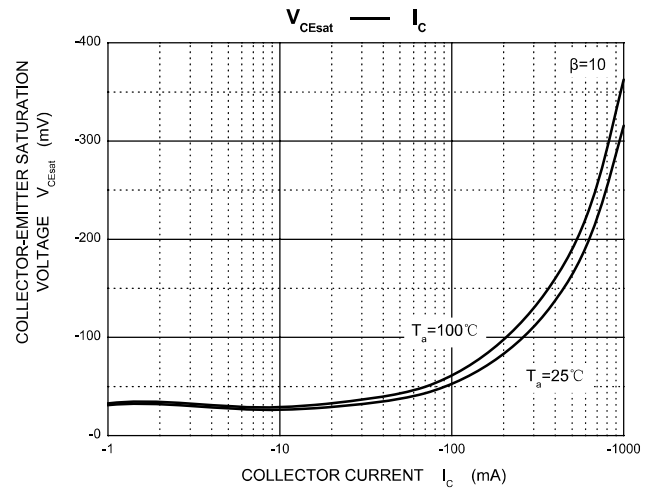
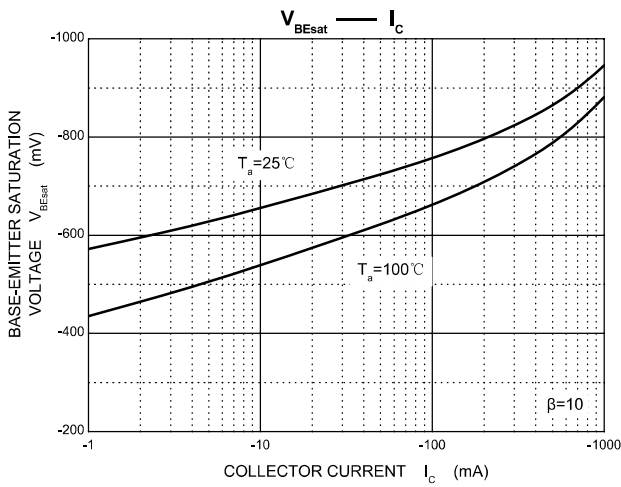
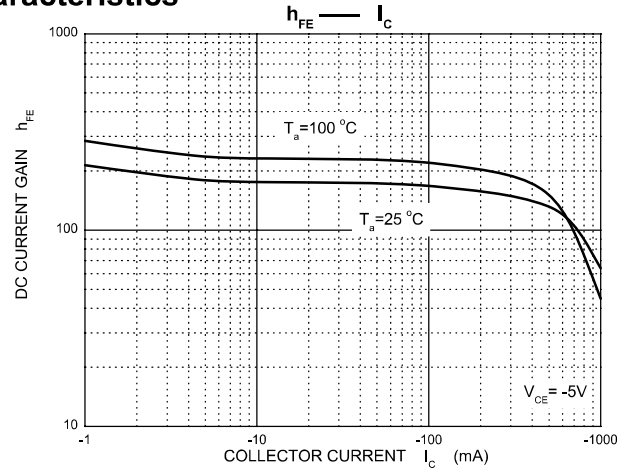
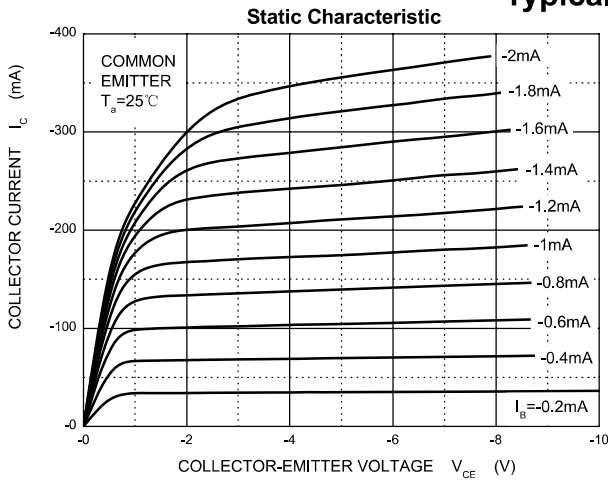

SOT-89 Package Outline Dimensions

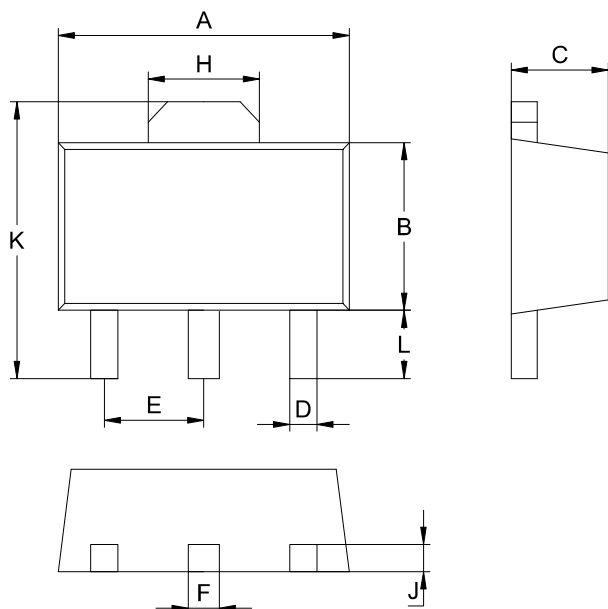

SOT-89		
Dim	Min	Max
A	4.30	4.70
B	2.20	2.70
C	1.30	1.70
D	0.30	0.60
E	1.40	1.60
F	0.30	0.60
H	1.40	1.80
J	0.30	0.60
L	0.90	1.10
K	3.75	4.35
All Dimensions in mm		

SOT-89 Suggested Pad Layout

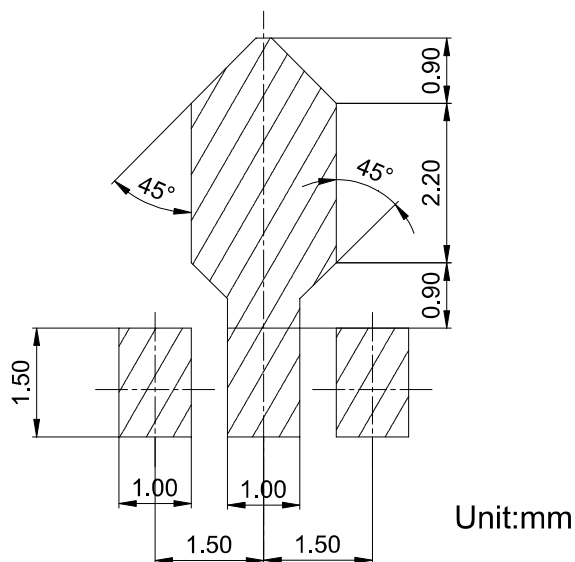

PACKAGE INFORMATION

Device	Package	Shipping
78L05	SOT-89	1000/Tape&Reel

X-ON Electronics

Largest Supplier of Electrical and Electronic Components

Click to view similar products for [Bipolar Transistors - BJT category](#):

Click to view products by [FUXINSEMI manufacturer](#):

Other Similar products are found below :

[619691C](#) [MCH4017-TL-H](#) [MMBT-2369-TR](#) [BC546/116](#) [BC557/116](#) [BSW67A](#) [NJVMJD148T4G](#) [NTE123AP-10](#) [NTE153MCP](#) [NTE16](#)
[NTE195A](#) [NTE92](#) [C4460](#) [2N4401-A](#) [2N6728](#) [2SA1419T-TD-H](#) [2SA2126-E](#) [2SB1204S-TL-E](#) [2SC2712S-GR,LF](#) [2SC5488A-TL-H](#)
[2SD2150T100R](#) [SP000011176](#) [2N2907A](#) [2N3904-NS](#) [2N5769](#) [2SC2412KT146S](#) [2SD1816S-TL-E](#) [CPH6501-TL-E](#) [MCH4021-TL-E](#)
[MJE340](#) [US6T6TR](#) [NJL0281DG](#) [732314D](#) [CPH3121-TL-E](#) [CPH6021-TL-H](#) [873787E](#) [IMZ2AT108](#) [UMX21NTR](#) [MCH6102-TL-E](#)
[NJL0302DG](#) [2N3583](#) [30A02MH-TL-E](#) [NSV40301MZ4T1G](#) [NTE13](#) [NTE26](#) [NTE282](#) [NTE323](#) [NTE350](#) [NTE81](#) [STX83003-AP](#)