

Features

- Low current rectification and high speed switching.
- Small surface mount type.
- Up to 200mA current capability.
- Low forward voltage drop.
- Silicon epitaxial planar chip, metal silicon junction.
- Lead-free parts for green partner, exceeds environmental standards of MIL-STD-19500 /228
- High speed (trr < 5 ns)

Mechanical data

- Epoxy:UL94-V0 rated flame retardant
- Case : Molded plastic, SOT-23
- Terminals : Solder plated, solderable per MIL-STD-750, Method 2026
- Mounting Position : Any

Package outline

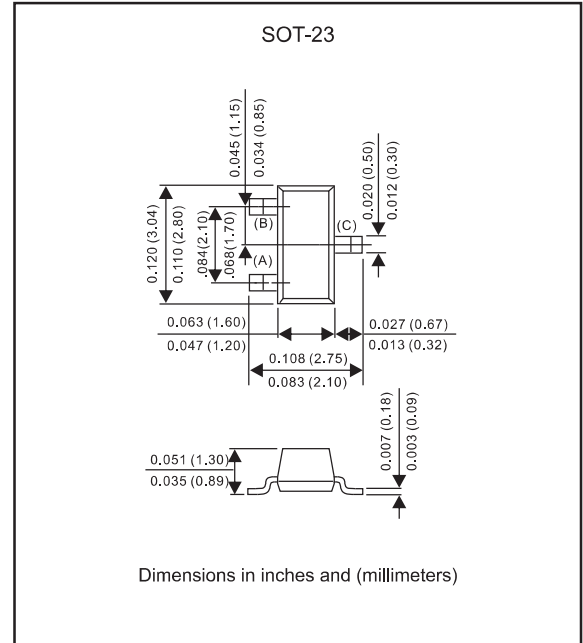

Maximum ratings and Electrical Characteristics (AT T_A=25°C unless otherwise noted)

PARAMETER	CONDITIONS	Symbol	MIN.	TYP.	MAX.	UNIT
Repetitive peak reverse voltage		V _{RRM}			30	V
Reverse voltage		V _R			30	V
Total Device dissipation	FR-5 board, (Note 1) T _A = 25°C Derate above 25°C	P _D			200 2.0	mW mW/°C
Repetitive peak forward current		I _{FRM}			300	mA
Forward surge current	tp<1s	I _{FSM}			600	mA
Forward current		I _F			200	mA
Thermal Resistance	Junction to ambient	R _{θJA}		500		°C/W
Operating Junction temperature range		T _J	-55		+125	°C
Storage temperature range		T _{STG}	-55		+125	°C
Forward voltage	I _F = 0.1 mA	V _F		0.220	0.240	V
	I _F = 1 mA	V _F		0.290	0.320	V
	I _F = 10 mA	V _F		0.350	0.400	V
	I _F = 30 mA	V _F		0.410	0.500	V
	I _F = 100 mA	V _F		0.520	1.000	V
Reverse current	V _R = 25 V	I _R		0.5	2.0	uA
Diode capacitance	V _R = 1 V, f = 1MHz	C _J		7.6	10.0	pF
Reverse recovery time	I _F = I _R = 10 mAdc, I _{R(REC)} = 1.0 mAdc	trr			5	ns

Note : 1.FR-5 = 1.0 x 0.75 x 0.062 in

Rating and characteristic curves for each diode (BAT54 / A / C / S)

FIG.1-TYPICAL FORWARD CHARACTERISTICS

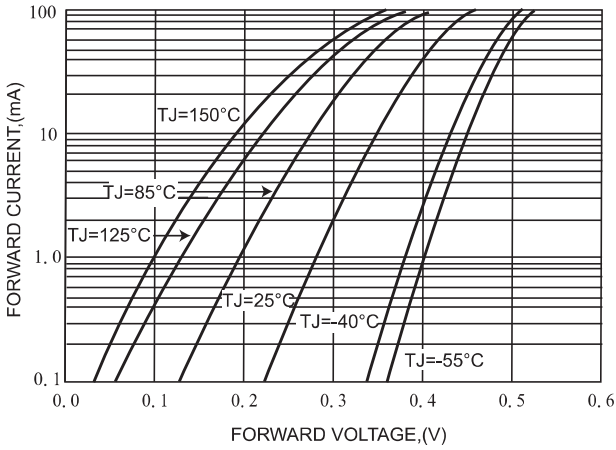

FIG.2 - TYPICAL LEAKAGE CURRENT CHARACTERISTICS

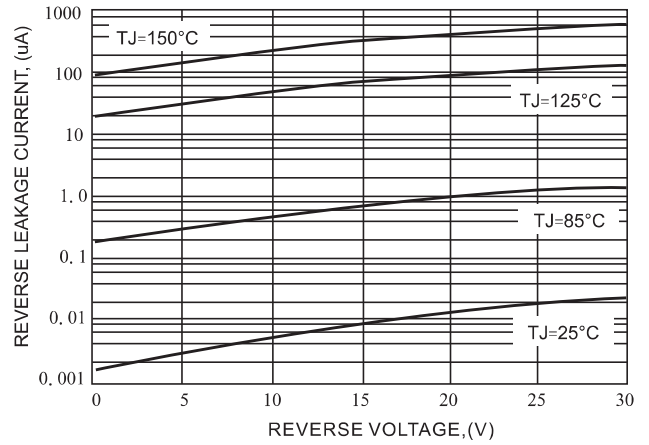
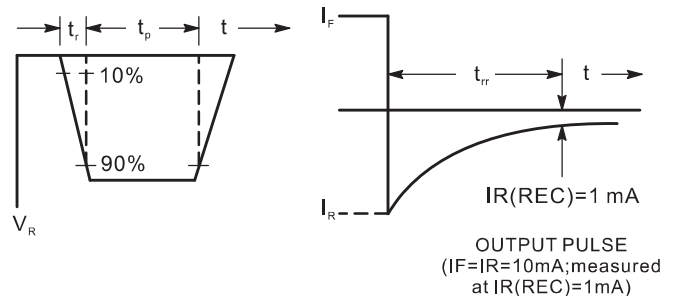
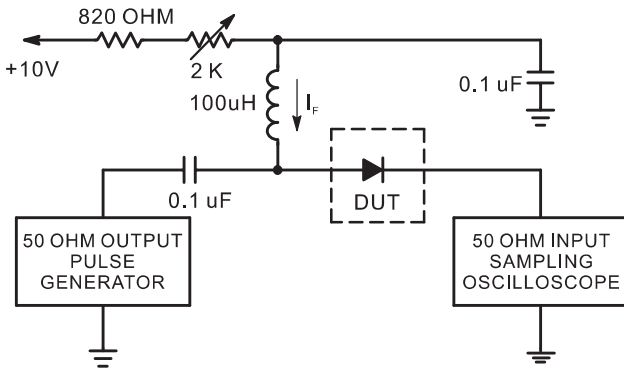
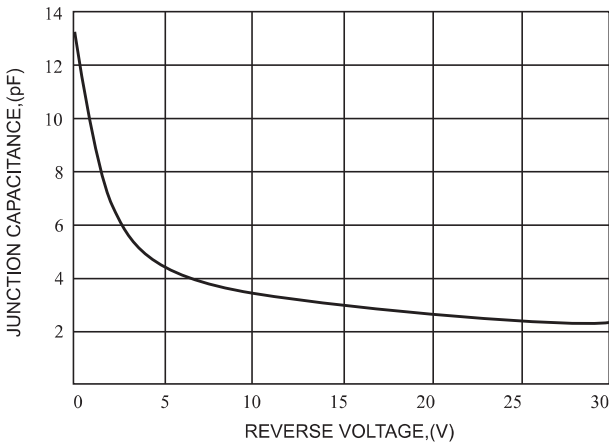

FIG.3-TYPICAL JUNCTION CAPACITANCE



- Notes : 1. A2.0 Kohm variable resistor adjusted for a forward Current (I_F) of 10mA.
- 2. Input pulse is adjusted so $I_R(\text{peak})$ is equal to 10 mA.
- 3. $t_p \gg t_{rr}$.

Recovery Time Equivalent Test Circuit

Pinning information

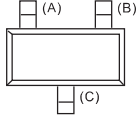
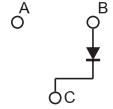
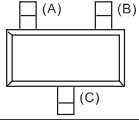
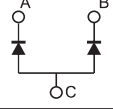
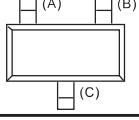
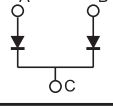
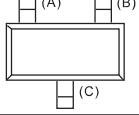
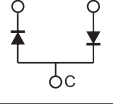
Type number	Marking code	Simplified outline	Symbol
BAT54	KL1		
BAT54A	KL2		
BAT54C	KL3		
BAT54S	KL4		

Suggested solder pad layout

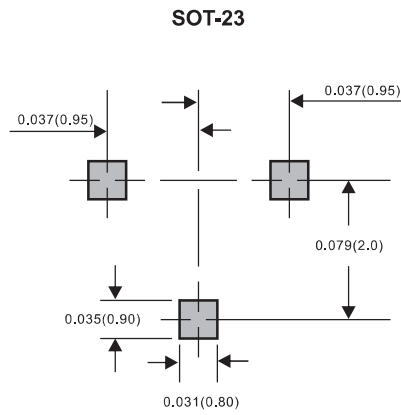

Dimensions in inches and (millimeters)

X-ON Electronics

Largest Supplier of Electrical and Electronic Components

Click to view similar products for [Schottky Diodes & Rectifiers](#) category:

Click to view products by [FUXINSEMI](#) manufacturer:

Other Similar products are found below :

[MA4E2039](#) [MA4E2508M-1112](#) [MBR10100CT-BP](#) [MBR1545CT](#) [MMBD301M3T5G](#) [GS1JE-TP](#) [RB160M-50TR](#) [BAS16E6433HTMA1](#)
[BAS 3010S-02LRH E6327](#) [BAT 54-02LRH E6327](#) [NSR05F40QNXT5G](#) [NSVR05F40NXT5G](#) [NTE555](#) [JANS1N6640](#) [SB07-03C-TB-H](#)
[SK310-T](#) [SK33A-TP](#) [SK34B-TP](#) [SS3003CH-TL-E](#) [PDS3100Q-7](#) [GA01SHT18](#) [CRS10I30A\(TE85L,QM](#) [MA4E2501L-1290](#)
[MBRB30H30CT-1G](#) [DMJ3940-000](#) [SB007-03C-TB-E](#) [SK32A-TP](#) [SK33B-TP](#) [SK35A-TP](#) [SK38B-LTP](#) [SK38B-TP](#) [NRVBM120LT1G](#)
[NTE505](#) [NTSB30U100CT-1G](#) [VS-6CWQ10FNHM3](#) [CRG04\(T5L,TEMQ\)](#) [ACDBA1100LR-HF](#) [ACDBA1200-HF](#) [ACDBA2100-HF](#)
[ACDBA240-HF](#) [ACDBA3100-HF](#) [CDBQC0530L-HF](#) [ACDBA260LR-HF](#) [ACDBA1100-HF](#) [MA4E2502L-1246](#) [10BQ060-M3/5BT](#)
[NRVB130LSFT1G](#) [CRS08TE85LQM](#) [PMAD1108-LF](#) [B120Q-13-F](#)